



Earn BISSELL Rewards!

Register your product today!
See details on back page

REWIND
PREMIUM™
pet

REWIND
PREMIER™
pet

USER'S GUIDE
44M3, 67F8 SERIES

- 2 Thank You
- 3 Safety instructions
- 4 Product view
- 5 Assembly
- 6-9 Operations
- 10-15 Maintenance and care
- 16-17 Troubleshooting
- 17 Replacement parts
- 18 Accessories
- 19 Warranty
- 20 Product registration
- 20 Consumer services



Thanks for buying a BISSELL Vacuum

We're glad you purchased a BISSELL vacuum. Everything we know about floor care went into the design and construction of this complete, high-tech home cleaning system.

Your BISSELL vacuum is well made, and we back it with a limited three year warranty. We also stand behind it with a knowledgeable, dedicated Consumer Services department, so, should you ever have a problem, you'll receive fast, considerate assistance.

My great-grandfather invented the floor sweeper in 1876. Today, BISSELL is a global leader in the design, manufacture, and service of high quality homecare products like your BISSELL upright vacuum.

Thanks again, from all of us at BISSELL.

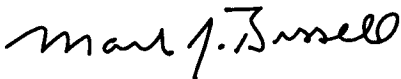

Mark J. Bissell
Chairman, President & CEO

IMPORTANT SAFETY INSTRUCTIONS

When using an electrical appliance, basic precautions should be observed, including the following:

READ ALL INSTRUCTIONS BEFORE USING YOUR UPRIGHT VACUUM.

Always connect to a polarized outlet (left slot is wider than right). Unplug from outlet when not in use and before conducting maintenance.

WARNING: To reduce the risk of fire, electric shock, or injury:

- Do not modify the polarized plug to fit a non-polarized outlet or extension cord.
- Do not leave vacuum cleaner unattended when it is plugged in.
- Unplug from outlet when not in use and before servicing.
- Unplug before attaching the TurboBrush.
- Do not use outdoors or on wet surfaces.
- Do not allow children to operate vacuum cleaner or use as a toy.
- Close attention is necessary when used by or near children.
- Do not use for any purpose other than described in this user's guide.
- Use only manufacturer's recommended attachments.
- Do not use with damaged cord or plug.
- If appliance is not working as it should, has been dropped, damaged, left outdoors, or dropped into water, have it repaired at an authorized service center.
- Do not pull or carry by cord, use cord as a handle, close a door on cord, or pull cord around sharp edges or corners. Do not run appliance over cord. Keep cord away from heated surfaces.
- Do not unplug by pulling on cord. To unplug, grasp the plug, not the cord.
- Do not handle vacuum cleaner or plug with wet hands.
- Do not put any object into openings. Do not use with any opening blocked; keep openings free of dust, lint, hair, and anything that may reduce air flow.

- Keep hair, loose clothing, fingers, and all parts of body away from openings and moving parts.
- Turn off all controls before plugging or unplugging vacuum cleaner.
- Use extra care when cleaning stairs.
- Do not pick up flammable materials (lighter fluid, gasoline, kerosene, etc.) or use in the presence of explosive liquids or vapors.
- Do not pick up toxic material (chlorine bleach, ammonia, drain cleaner, etc.).
- Do not use vacuum cleaner in an enclosed space filled with vapors given off by oil base paint, paint thinner, some moth proofing substances, flammable dust, or other explosive or toxic vapors.
- Do not pick up hard or sharp objects such as glass, nails, screws, coins, etc.
- Do not pick up anything that is burning or smoking, such as cigarettes, matches, or hot ashes.
- Do not use without filters in place.
- Use only on dry, indoor surfaces.
- Keep appliance on a level surface.
- Do not carry the vacuum cleaner while it is running.
- Hold plug when rewinding onto cord reel. Do not allow plug to whip when rewinding.

SAVE THESE INSTRUCTIONS FOR FUTURE USE

THIS APPLIANCE HAS A POLARIZED PLUG.

To reduce the risk of electric shock, this appliance has a polarized plug (one blade is wider than the other). This plug will fit in a polarized outlet only one way. If the plug does not fit fully in the outlet, reverse the plug. If it still does not fit, contact a qualified electrician to install a proper outlet. Do not change the plug in any way.

This model is for household use only.

Product view

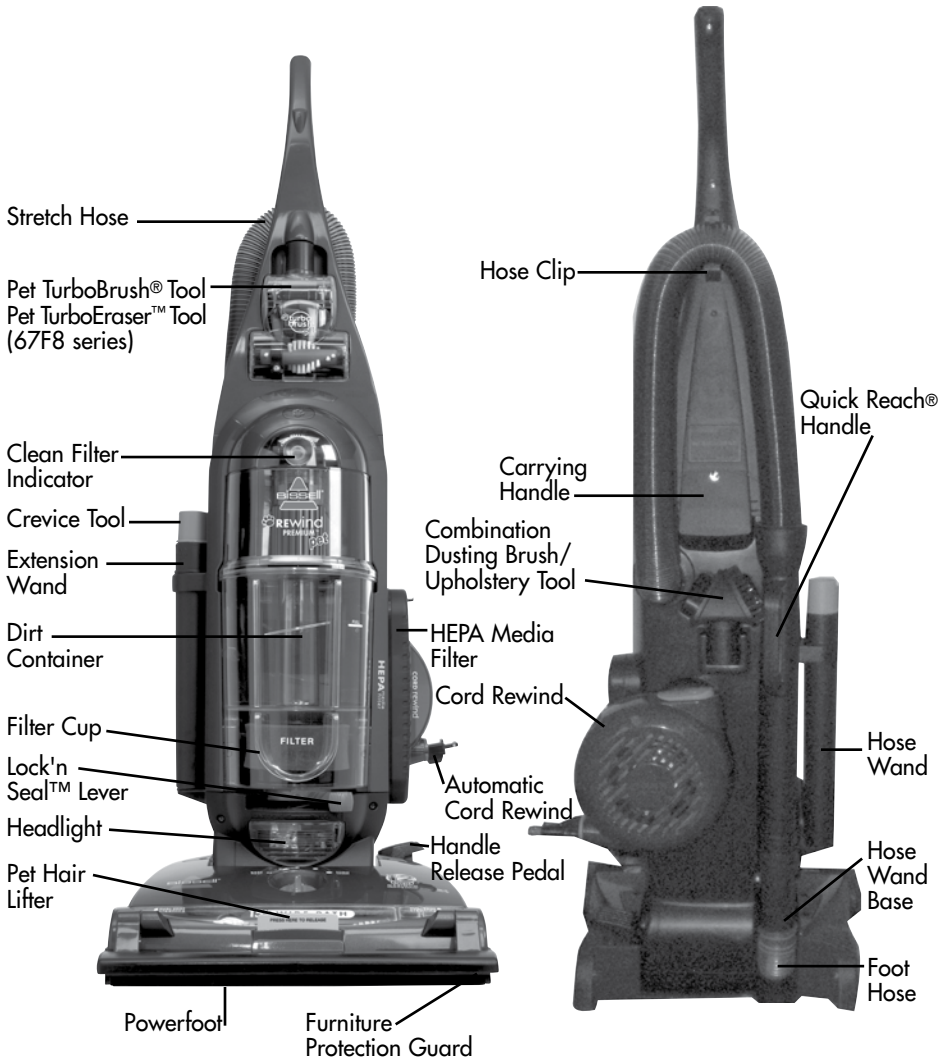

CAUTION:

Do not plug in your vacuum cleaner until you are familiar with all instructions and operating procedures.



WARNING:

Plastic film can be dangerous. To avoid danger of suffocation, keep away from babies and children.

Assembly

You need: Phillips head screwdriver.

Attach handle to vacuum

1. Locate the vacuum handle and remove the screw packet (1 screw) taped to the base of the handle.
2. Stand the vacuum upright and slide the base of the handle firmly into the grooves at the top of the vacuum body.
3. **IMPORTANT** – Continue to push firmly until the handle is flush with the front of the vacuum body.
4. Insert the screw provided and tighten securely.

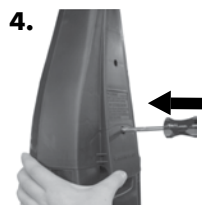
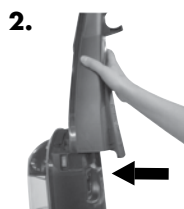

Attach vacuum hose and tools

1. Attach the Twist 'n Snap™ hose by lining up the tabs on the base with the corresponding notches on the back of the vacuum. Turn the Twist 'n Snap hose to the right to lock the hose into place.
2. Grasping the Quick Reach® handle, slide the end of the hose wand onto the hose wand base. Snap the hose into the hose clip.
3. Slide the extension wand and the crevice tool together into the storage holder.
4. Snap the combination tool into the storage clip.
5. Attach the Pet TurboBrush by aligning the small holes near the brush roll with the tabs at the bottom of TurboBrush housing. Snap TurboBrush into place.
6. Flip the Pet Hair Lifter down until it clicks into place on the front of the foot.

NOTE: The Powerfoot will not suction properly unless the hose wand is firmly attached.

NOTE: 67F8 series includes Pet TurboEraser™ Tool.

NOTE: Flip the Pet Hair Lifter down for carpeted surfaces and up for non-carpeted surfaces.

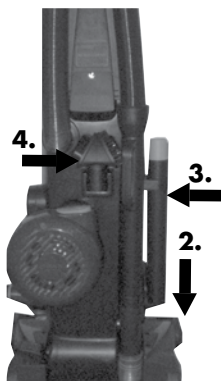

Operations

Automatic power cord rewind

1. Gently pull out power cord and stop when yellow line is visible. Do not pull power cord beyond the red line. Plug cord into electrical outlet.
2. To return cord, with vacuum power button OFF, remove plug from outlet. Hold plug and press automatic cord button to wind cord into reel. Do not allow plug to whip when rewinding.

Power switch

The power switch is located just below the hand on the side of the vacuum.

I - ON O - OFF

Handle position

Press the handle release pedal with your foot to place vacuum into one of three cleaning positions.

1. **Upright:** For storage, transporting, and above floor cleaning with tools.
 - Transporting in upright position by tilting vacuum on rear wheels and push forward or use carrying handle on back of handle base.
2. **Normal cleaning:** Press handle release pedal once for most household floor cleaning.
3. **Low cleaning:** From normal cleaning position, press handle release pedal once for cleaning under low furniture.



CAUTION:

Be careful to avoid injury as cord retracts very quickly.



CAUTION:

Before using your vacuum, make sure that the dirt container is in locked position and that all filters (inner circular, outer circular, pre-motor and post-motor) are in place. Do not operate your vacuum without these filters.

Operations

Height adjustment

Turn dial on powerfoot to adjust to one of five height adjustments. If dial is difficult to turn, tilt the cleaner back slightly to take the weight off the foot while turning.

Lowest setting – For low pile carpet or bare floors.

Medium setting – For medium pile carpet.

Highest setting – For high pile and most shag carpet. Adjust to high setting if difficult to push.



Tip:

Before cleaning under low furniture, check area first for objects that might harm the unit or block the vacuum hose.

Operations

Clean filter indicator

The indicator tells you when air flow in the vacuum is reduced due to dirty filters or a clog in the hose. The indicator will remain green until the air flow is reduced – and then will change to red. When fully red, the air flow is greatly reduced or clogged by a dirty filter; follow instructions on page 11 to clean/replace your filters.

Pet hair lifter

Use to pick up pet hair from carpeted surfaces. Vacuum like you normally would, as you pull the vacuum back pet hair collects on the lifter and releases it into the vacuum path as you push forward.

NOTE: Turn vacuum off before you flip Pet Hair Lifter up or down.

1. To vacuum carpeting, flip down until it clicks into place.
2. To vacuum non-carpet surfaces, push the yellow release button located in the center just above the feature.



Clean Filter Indicator



Operations

Tools

Attach desired tool to hose for above floor cleaning or hard to reach areas.

1. Raise handle to upright position.
2. Grasp the Quick Reach handle and lift hose wand to separate from suction intake opening.
3. Attach tools by firmly pushing onto vacuum hose or extension wand.

Crevice tool

Use in tight narrow spaces.

Combination dusting brush/upholstery tool

Two types of cleaning tools are included in one attachment. Rotate for desired tool. Use brush side to dust furniture, blinds, books, lamps, shelves and baseboards. Use the upholstery tool on cushions, draperies and fabrics.

Extension wand

Use with desired attachment for a longer reach.

Pet Contour Tool® (select models only)

Use to reach into corners and edges on stairs as well as armrests and other curved surfaces. The tool can be flipped to use in any direction.

Pet TurboBrush® Tool

67F8 series includes Pet TurboEraser™ Tool. Use rotating brush action for small flat areas such as cushions and beds.

NOTE: Press gently down and pull towards you in a raking motion. Too much pressure will cause the brush to stop rotating.

Tip:

Hair, string and small objects can block the vacuum hose or tools. Check them regularly for obstructions.



NOTICE:

These tools are designed to remove pet hair from upholstered or carpeted surfaces. They should not be used on pets.



CAUTION:

The rotating floor brush continues to rotate while tools are in use. To reduce the risk of injury from moving parts, always move the cleaner with the carrying handle at the back of the cleaner. Always place vacuum cleaner on floor with handle in upright position when using tools. Never place your fingers under the cleaner when it is running. Never place powerfoot on furniture or uneven surfaces. Do not place vacuum cleaner close enough to objects to pull them into rotating brush.

Maintenance and care

To maximize performance and extend life of your vacuum it is very important to perform the following maintenance steps:

Empty Dirt Container

Empty when dirt reaches the "Full" line on the container.

1. Turn power OFF. Unplug vacuum cord from electrical outlet.
2. Slide the Lock 'n Seal lever to the "Unlock" position.
3. Grasp dirt cup handle and pull straight out to remove from vacuum and empty.
4. Place dirt container back in the vacuum and slide the lever to the "Lock" position.

Note: The dirt container may be washed in warm water with a mild detergent. Make sure it is completely dry before replacing.



Tip:

For maximum cleaning performance, check and clean or replace all filters as suggested.

⚠ WARNING:

To reduce the risk of electric shock, turn power switch OFF and disconnect polarized plug from electrical outlet before performing maintenance or troubleshooting checks.

Maintenance and care

Cleaning the inner & outer circular filters

1. Turn power off. Unplug the cleaner from electrical outlet.
2. Remove the dirt container as described in the previous section. Grasp the filter cup located at the bottom of the dirt container, lift up and out. **DO NOT TRY TO PULL CIRCULAR FOAM FILTER OUT OF THE FILTER CUP WHILE IT IS STILL IN THE VACUUM.**
3. Grasp the plastic tab on the top of the circular foam filters. Twist to unlock and pull out.
4. Separate the outer foam and inner pleated circular filters. Wash each individually by hand in warm water. Mild detergent may be used if desired. Rinse well, then air dry thoroughly before putting them back together and replacing in filter cup.
5. The filter cup may be washed in warm water with a mild detergent. Make sure it is completely dry before reassembling with filters. **DO NOT PUT IN DISHWASHER.**
6. The upper tank and louvers may also be wiped clean with a damp cloth. Reach underneath the upper tank and turn the rim of the louvers to left to unlock. Pull straight down to remove. Make sure all parts are completely dry before replacing.
7. To replace louvers lift back into upper tank. Place top of louvers inside clear center cavity and turn toward the right to unlock until tabs fit into notch. Continue to turn to right until tight.

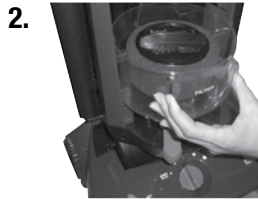

Cleaning the pre-motor filter

The pre-motor protects the motor from debris.

1. Turn power OFF. Unplug vacuum cord from electrical outlet.
2. The pre-motor filter is located underneath the filter cup in the center of the round part of the Lock 'n Seal lever.
3. Remove the small round filter and any debris on top of it. Rinse well under warm water, air dry completely before replacing.

⚠ WARNING:
Do not operate cleaner with damp or wet filters or without all filters in place.

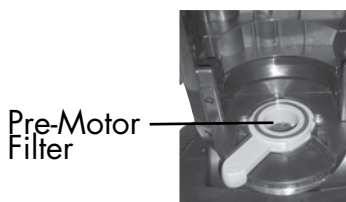

Maintenance and care

Replacing the post-motor filter

The post-motor assists in the filtration process to return clean air to the room.

1. Turn power OFF. Unplug vacuum cord from electrical outlet.
2. Locate filter behind the door on the side of the vacuum. Remove and replace when filter becomes dirty. The white, pleated HEPA media filter is not washable.



Checking rotating floor brush and drive belt

Check your vacuum's rotating floor brush and drive belt regularly for wear or damage.

1. Turn power OFF. Unplug vacuum cord from electrical outlet.
2. Place handle in low position and turn vacuum cleaner over so bottom side is up.
3. Remove the seven screws with a Phillips head screwdriver. Lift the brush cover off.
4. Grasp rotating floor brush at both ends and lift.
5. Clean strings, hair and other debris from rotating floor brush, paying particular attention to brush ends.
6. Clean strings, hair and other debris from motor pulley and drive belt areas.
7. Check drive belt carefully for wear, cuts or stressed areas.
8. Check air passageway for obstructions. Remove debris from this area.

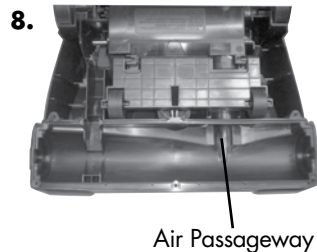
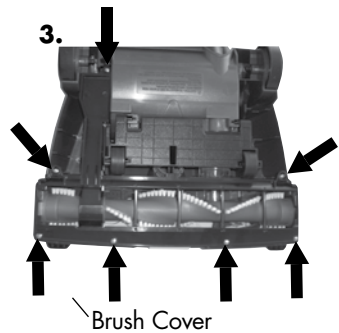

Maintenance and care

Replace drive belt

1. Turn power OFF. Unplug vacuum cord from electrical outlet.
2. With rotating floor brush removed from vacuum cleaner (steps 1-4 of Check rotating floor brush and drive belt), grasp old drive belt and remove from motor pulley. Discard old drive belt.
3. Place new drive belt over motor pulley and stretch other end over rotating floor brush in the space between the bristles.
4. Place ends of rotating floor brush down into slots on sides as shown.
5. Turn rotating floor brush by hand several times in the direction of motor pulley. If properly installed, drive belt will center itself on rotating brush.
6. Reposition brush cover and screw back into place.

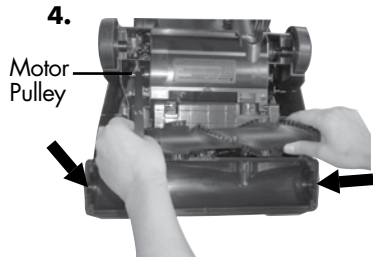
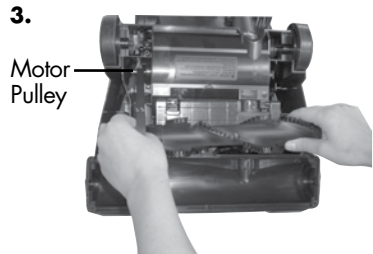

Maintenance and care

Pet TurboBrush® Tool Maintenance

NOTE: 67F8 models include the Pet TurboEraser™ Tool that follows the same maintenance steps as the Pet TurboBrush® Tool.

1. Turn power OFF. Unplug vacuum cord from electrical outlet.
2. Turn tool so bottom side faces up and remove the two screws.
3. Remove the faceplate and clear any obstructions.
4. Remove the brush from the drive belt to clean debris.
5. Reposition the drive belt on the brush, and place ends of brush in slots on the side. Reposition faceplate and secure with two screws.

NOTE: This tool is designed to remove pet hair from upholstered or carpeted surfaces. It should not be used on pets.

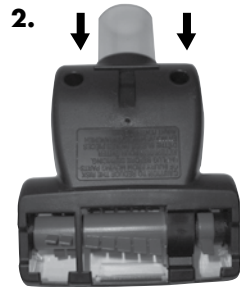

Maintenance and care

Clearing clogs

Low suction or poor pickup may be due to a clog in the vacuum cleaner. If you notice a change in the sound of the motor, check for clogs.

1. Turn power OFF. Unplug vacuum cord from electrical outlet.
2. Empty dirt container.
3. Check upper tank for build up or clogs.
4. Check the suction inlet for a clog.
5. Grasp the Quick Reach handle and lift hose wand to separate from the suction opening. Check for a clog in the base, the wand or the hose.
6. Remove the screw attaching the hose wand base to the vacuum. Straighten the hose wand base and unclog with long, narrow object such as a broom stick.
7. If the clog persists, follow the instructions for checking the rotating floor brush on page 12 and inspect the air passageway for obstructions

Replace Headlight

1. Turn power OFF. Unplug vacuum cord from electrical outlet.
2. Using a flat screwdriver, table knife or coin, insert into the slot on the right of the lens and gently push inner latch to the left as shown to remove the lens.
3. Reposition lens by inserting the tab on left side and then pushing the right side back into place.

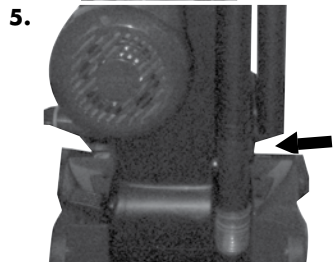
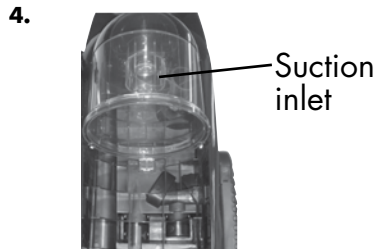

Troubleshooting

Vacuum cleaner won't turn on

Possible causes

1. Power cord not plugged in
2. Blown fuse/tripped breaker
3. Damaged cord

Vacuum cleaner won't pick up dirt

Possible causes

1. Incorrect height adjustment
2. Hose not attached to suction opening
3. Crack or hole in hose
4. Broken or worn drive belt
5. Rotating floor brush bristles worn
6. Rotating floor brush jammed
7. Clog in vacuum
8. Dirt container full
9. Dirt container or upper tank not installed properly
10. Pet TurboBrush® is clogged or debris is wrapped
10. Filters are dirty

Tool won't pick up dirt

Possible causes

1. Crack or hole in hose
2. Clog in vacuum
3. Dirt container full
4. Dirt container or upper tank not installed properly
5. Filters are dirty

Visible dirt escaping from cleaner

Possible causes

1. Dirt container full
2. Filters missing or installed incorrectly

Cord will not retract

Possible causes

1. Knotted or twisted

Remedies

1. Check electrical plug
2. Check/replace fuse or reset breaker
3. Refer to a BISSELL authorize service center for repair or replacement

Remedies

1. Adjust powerfoot to correct height setting
2. Grasp quick reach handle and firmly push hose wand onto the suction opening
3. Check hose and replace if needed
4. Replace drive belt, see page 13
5. Replace brush
6. Remove brush and clean debris from brush ends
7. Follow instructions on page 15 for clearing clogs
8. Empty dirt container
9. Position correctly and lock in place
10. Maintaining Pet TurboBrush see pg 14
10. Check and clean pre-motor and HEPA media post-motor filters, see pages 11 & 12

Remedies

1. Check hose and replace if needed
2. Follow instructions on page 15 for clearing clogs
3. Empty dirt container
4. Position correctly and lock in place
5. Check and clean pre-motor and post-motor filters see pages 11 & 12

Remedies

1. Empty dirt container
2. Check pre-motor and post-motor filters for correct installation see pages 11 & 12

Remedies

1. Follow instructions on page 6

Troubleshooting

Other maintenance or service not included in the manual should be performed by an authorized service representative.

Thank you for selecting a BISSELL product.

Please do not return this product to the store.

For any questions or concerns, BISSELL is happy to be of service. Contact us directly at 1-800-237-7691.

Replacement parts - BISSELL vacuum

Item	Part No.	Part Name
1	32074	Style 9 Drive Belt (2-Pack)
2	203-1297	Standard Headlight Bulb
3	203-2468	Hose Assembly
4	203-2449	Brush Dowel (15")
5	32R9	Style 16 Inner and Outer Circular Pre-Motor Filter Set
6	73K1	Style 16 Inner Circular Pre-Motor Filter
7	69B1	Style 16 Outer Circular Pre-Motor Filter
8	32076	Style 7/9/16 Post-Motor HEPA Media Filter
9	203-1215	Style 7/9/16 Pre-Motor Filter
10	203-7130	Pet Hair Lifter

1



2



3



4



5



6



7



8



9



10



Accessories - BISSELL vacuum

These items are available for purchase as accessories for your BISSELL vacuum: To purchase call 1-800-237-7691 or visit www.bissell.com.

Item	Part No.	Part Name
1	203-2447	Pet TurboBrush® Tool (44M3 series only)
2	203-1063	Crevice Tool
3	203-1099	Combination Dusting/Upholstery Brush
4	203-1084	Extension Wand
5	203-1368	Pet Contour Tool® (44M3 series only)
6	203-7529	Pet TurboEraser™ Tool (67F8 series only)



Warranty - BISSELL Vacuum

This warranty gives you specific legal rights, and you may also have other rights which may vary from state to state. If you need additional instruction regarding this warranty or have questions regarding what it may cover, please contact BISSELL Consumer Services by E-mail, telephone, or regular mail as described below.

Limited Three Year Warranty

Subject to the *EXCEPTIONS AND EXCLUSIONS identified below, upon receipt of the product BISSELL Homecare, Inc. will repair or replace (with new or remanufactured components or products), at BISSELL's option, free of charge from the date of purchase by the original purchaser, for three years any defective or malfunctioning part.

See information below on "If your BISSELL product should require service".

This warranty applies to product used for personal, and not commercial or rental service. This warranty does not apply to fans or routine maintenance components such as filters, belts, or brushes. Damage or malfunction caused by negligence, abuse, neglect, unauthorized repair, or any other use not in accordance with the User's Guide is not covered.

If your BISSELL product should require service:

Contact BISSELL Consumer Services to locate a BISSELL Authorized Service Center in your area.

If you need information about repairs or replacement parts, or if you have questions about your warranty, contact BISSELL Consumer Services.

Website or E-mail:

www.bissell.com

Use the "Customer Support" tab.

Or Call:

BISSELL Consumer Services

1-800-237-7691

Monday - Friday 8 a.m. - 10 p.m. ET

Saturday 9 a.m. - 8 p.m. ET

Or Write:

BISSELL Homecare, Inc.

PO Box 3606

Grand Rapids, MI 49501

ATTN: Consumer Services

BISSELL HOMECARE, INC. IS NOT LIABLE FOR INCIDENTAL OR CONSEQUENTIAL DAMAGES OF ANY NATURE ASSOCIATED WITH THE USE OF THIS PRODUCT. BISSELL'S LIABILITY WILL NOT EXCEED THE PURCHASE PRICE OF THE PRODUCT.

Some states do not allow the exclusion or limitation of incidental or consequential damages, so the above limitation or exclusion may not apply to you.

*EXCEPTIONS AND EXCLUSIONS FROM THE TERMS OF THE LIMITED WARRANTY

THIS WARRANTY IS EXCLUSIVE AND IN LIEU OF ANY OTHER WARRANTIES EITHER ORAL OR WRITTEN. ANY IMPLIED WARRANTIES WHICH MAY ARISE BY OPERATION OF LAW, INCLUDING THE IMPLIED WARRANTIES OF MERCHANTABILITY AND FITNESS FOR A PARTICULAR PURPOSE, ARE LIMITED TO THE THREE YEAR DURATION FROM THE DATE OF PURCHASE AS DESCRIBED ABOVE.

Some states do not allow limitations on how long an implied warranty last so the above limitation may not apply to you.

Don't forget to register your product!

Registering is quick, easy and offers you benefits over the lifetime of your product. You'll receive:

BISSELL Rewards Points

Automatically earn points for discounts and free shipping on future purchases.

Faster Service

Supplying your information now saves you time should you need to contact us with questions regarding your product.

Product Support Reminders and Alerts

We'll contact you with any important product maintenance reminders and alerts.

Special Promotions

Optional: Register your email to receive notice of offers, contests, cleaning tips and more!

Visit www.bissell.com/registration now!

BISSELL consumer services

For information about repairs or replacement parts, or questions about your warranty, call:

BISSELL Consumer Services

1-800-237-7691

Monday - Friday 8 a.m. — 10 p.m. ET

Saturday 9 a.m. — 8 p.m. ET

Or write:

BISSELL Homecare, Inc.

PO Box 3606

Grand Rapids MI 49501

ATTN: Consumer Services

Or visit the BISSELL website - **www.bissell.com**

When contacting BISSELL, have model number of cleaner available.

Please record your Model Number: _____

Please record your Purchase Date: _____

NOTE: Please keep your original sales receipt. It provides proof of purchase date in the event of a warranty claim. See Warranty on page 19 for details.



©2011 BISSELL Homecare, Inc.
Grand Rapids, Michigan
All rights reserved. Printed in Korea
Part Number 110-4312
Rev 1/11
Visit our website at:
www.bissell.com

Free Manuals Download Website

<http://myh66.com>

<http://usermanuals.us>

<http://www.somanuals.com>

<http://www.4manuals.cc>

<http://www.manual-lib.com>

<http://www.404manual.com>

<http://www.luxmanual.com>

<http://aubethermostatmanual.com>

Golf course search by state

<http://golfingnear.com>

Email search by domain

<http://emailbydomain.com>

Auto manuals search

<http://auto.somanuals.com>

TV manuals search

<http://tv.somanuals.com>