

# COLORADO™ 1<sub>IP</sub>

## User Manual

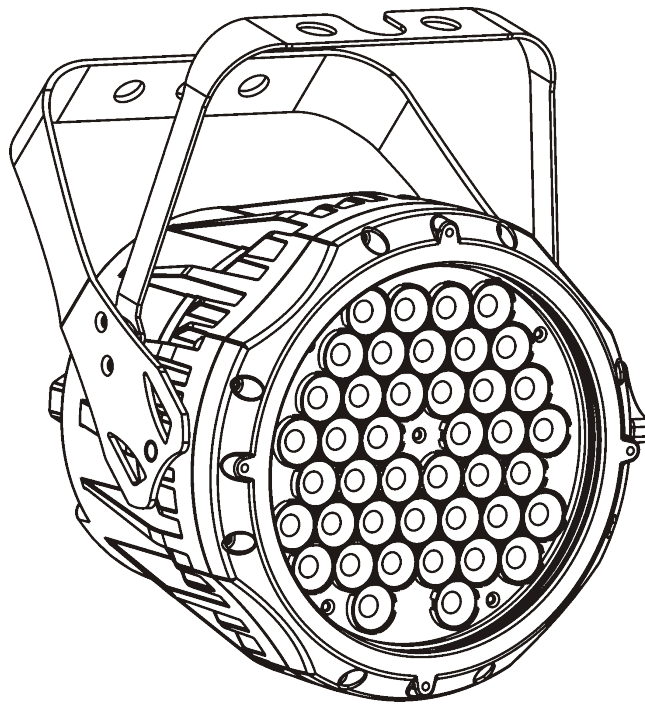

  
**CHAUVET®**

## Edition Notes

The COLORado™ 1 IP User Manual Rev. 01c covers the description, safety precautions, installation, programming, operation, and maintenance of the COLORado™ 1 IP. CHAUVET® released this edition of the COLORado™ 1 IP User Manual Rev. 01c in October 2010.

## Trademarks

CHAUVET® is a registered trademark of CHAUVET & Sons Inc. (d/b/a CHAUVET® or Chauvet). The CHAUVET® logo in its entirety including the Chauvet name and the dotted triangle, and all other trademarks on this manual pertaining to services, products, or marketing statements (example: It's Green Thinking™) are owned or licensed by CHAUVET®. Any other product names, logos, brands, company names, and other trademarks featured or referred to within this document are the property of their respective trademark holders.

## Copyright Notice

CHAUVET® owns the content of this user manual in its entirety, including but not limited to pictures, logos, trademarks, and resources.

© Copyright 2010 CHAUVET®. All rights reserved

Electronically published by CHAUVET® in the United States of America

## Manual Usage

CHAUVET® authorizes its customers to download and print this manual for professional information purposes only. CHAUVET® expressly prohibits the usage, copy, storage, distribution, modification, or printing of this manual or its content for any other purpose without its written consent.

## Document Printing

For better results, print this document in color, on letter size paper (8.5 x 11 inches), double sided. If using A4 paper (210 x 297 mm), configure your printer to scale the content of this document to A4 paper.

## Intended Audience

Any person in charge of installing, operating, and/or maintaining the COLORado™ 1 IP should read the guide that shipped with it as well as this manual in their entirety before installing, operating, or maintaining this product.

## Disclaimer

CHAUVET® believes that the information contained in this manual is accurate in all respects. However, CHAUVET® assumes no responsibility for any error or omissions in this document. CHAUVET® reserves the right to revise this document and to make changes from time to time in the content hereof without obligation of CHAUVET® to notify any person or company of such revision or changes. This does not constitute in any way a commitment by CHAUVET® to make such changes. CHAUVET® may issue a revision of this manual or a new edition of it to incorporate such changes.

## CHAUVET® Publications Hot Line











If you have any comments about the accuracy of this document or general suggestions regarding how we can improve it, please call us at (800) 762-1084 (US callers) or +1-954-929-1115 (international callers). You can download the latest versions of all CHAUVET® products' manuals from [www.chauvetlighting.com](http://www.chauvetlighting.com).

## Document Revision

The COLORado™ 1 IP User Manual Rev. 01c supersedes all previous versions of this manual. Please discard any older versions of this manual you may have, whether in printed or electronic format, and replace them with this version.

Author	Editor	Manager	PD Manager
O. Desmonteix	D. Coupee	M. Graham	F. Sellers

## Product at a Glance

Use on Dimmer		Auto Programs	
Outdoor Use		Auto-ranging Power Supply	
Sound Activated		Replaceable Fuse	
DMX		User Serviceable	
Master/Slave		Duty Cycle	

# Table of Contents

<b>1. Before You Begin .....</b>	<b>1</b>
What is Included.....	1
Unpacking Instructions .....	1
Typographic Conventions .....	1
Icon Meaning.....	1
Safety Notes.....	2
Expected LED Lifespan .....	2
<b>2. Introduction .....</b>	<b>3</b>
Product Description .....	3
Features.....	3
<i>Additional Features</i> .....	3
<i>Options</i> .....	3
DMX Channel Summary .....	4
Product Overview .....	5
<b>3. Setup .....</b>	<b>6</b>
AC Power .....	6
<i>AC Plug</i> .....	6
<i>Power Linking</i> .....	6
<i>Fuse Replacement</i> .....	6
DMX Linking.....	6
<i>DMX Modes</i> .....	6
<i>Master/Slave Connectivity</i> .....	7
ID Addressing.....	7
Lens Replacement.....	7
Mounting .....	8
<i>Orientation</i> .....	8
<i>Rigging</i> .....	8
<b>4. Operation .....</b>	<b>9</b>
Control Panel Description .....	9
Control Options .....	9
Programming.....	9
<i>DMX Personality</i> .....	9
<i>DMX Control Without ID Addressing</i> .....	9
<i>DMX Control With ID Addressing</i> .....	10
<i>Static Color</i> .....	10
<i>Auto Programs</i> .....	10
<i>Edit Customs</i> .....	10
<i>Master/Slave</i> .....	10
<i>Color Adjustment</i> .....	11
<i>Dimmer Curves</i> .....	11
<i>Control Panel Lock</i> .....	11
<i>Program Upload</i> .....	11
<i>Reset</i> .....	12
<i>Whites Setting</i> .....	12
<i>White Calibration</i> .....	12
TOUR Notes.....	13
<i>Master Dimmer</i> .....	13
<i>Red, Green, Blue, &amp; White Color Selection</i> .....	13
<i>Color Macros</i> .....	13
<i>Strobe</i> .....	13
<i>Auto</i> .....	13
<i>Dimmer Speed</i> .....	13
<i>ID Address Selection</i> .....	13
Menu Map .....	14



---

DMX Values .....	15
<i>TOUR</i> .....	15
<i>ARC1</i> .....	16
<i>ARC1 + D</i> .....	16
<i>ARC2</i> .....	16
<i>ARC2 + D</i> .....	16
<i>ARC2 + S</i> .....	17
<i>HSV</i> .....	17
<b>5. Technical Information .....</b>	<b>18</b>
General Maintenance.....	18
Troubleshooting Guide.....	19
Exploded View.....	20
Photometrics.....	21
Returns Procedure.....	22
Claims .....	22
Contact Us.....	22
Technical Specifications.....	23

# 1. Before You Begin

## What is Included

- One COLORado™ 1 IP
- One power input cable (IP66 to Edison, US market)
- One IP66 power extension cable
- One IP66 signal extension cable
- One DMX input cable (IP66 to 3-pin XLR male)
- One DMX output cable (IP66 to 3-pin XLR female)
- One gel frame holder
- One safety cable
- One Warranty Card
- One Quick Reference Guide

## Unpacking Instructions



Immediately upon receiving this product, carefully unpack it and check the container in which you received it. Make sure that you have received all the parts indicated above and that they are all in good condition. If the material inside the container (this product and any other accessory included with it) appears damaged from shipping, or if the container shows signs of mishandling, notify the shipper immediately. In addition, retain the container and all the packing material for inspection.

See the *Claims* section in the *Technical Information* chapter.

## Typographic Conventions

Convention	Meaning
1~512	A range of values in the text
50/60	A set of mutually exclusive values in the text
[10]	A DIP switch to be configured
<i>Claims</i>	A new term, or a section or chapter in this document
"COLORado™ UM"	The name of another publication or manual
<SET>	A button on the fixture's control panel
<b>Settings</b>	A fixture function or a menu option
<b>MENU &gt; Settings</b>	A sequence of menu options
1~10	A range of menu values from which to choose in a menu
Yes/No	A set of two mutually exclusive menu options in a menu
ON	A unique value to entered or select in a menu

## Icon Meaning

Icon	Meaning
	This icon indicates critical installation, configuration, or operation information. Failure to comply with this information may render the fixture partially or completely inoperative, damage third-party equipment, or cause harm to the user.
	This icon indicates important installation or configuration information. Failure to comply with this information may prevent the fixture from functioning correctly.
	This icon indicates useful, although non-critical information.



The term "DMX" used throughout this document refers to the USITT DMX512-A transmission protocol.

## Safety Notes

Please read the following notes carefully because they include important safety information about the installation, usage, and maintenance of this product.

It is important to read all these notes before starting to work with this product.



**There are no user serviceable parts inside this product. Any reference to servicing it you may find from now on in this User Manual will only apply to properly CHAUVET® certified technicians. Do not open the housing or attempt any repairs unless you are one of them.**



**Please refer to all applicable local codes and regulations for the proper installation of this product.**



**Keep this manual for future consultation. If you sell this product to another user, make sure that they also receive this manual.**

### Personal Safety

- Avoid direct eye exposure to the light source while the fixture is on.
- Always disconnect this product from its power source before servicing.
- Always connect this product to a grounded circuit to avoid the risk of electrocution.
- Do not touch this product's housing when operating because it may be very hot.

### Mounting and Rigging

- This product is for indoor and outdoor use (IP66). Do not submerge it.
- Make sure there are no flammable materials close to this product while operating.
- When hanging this product, always secure it to a fastening device using a safety cable (included).

### Power and Wiring

- Always make sure that you are connecting this product to the proper voltage, as per the specifications in this manual or on the product's sticker.
- Never connect this product to a dimmer pack or rheostat.
- Make sure the product's housing or power cable are not cracked, crimped, or damaged.
- Never disconnect this product by pulling or tugging on the power cable.

### Operation

- Do not operate this fixture if you see damage on the housing, lenses, or cables; have the damaged parts replaced by an authorized technician at once.
- The maximum ambient temperature (Ta) is 104° F (40° C). Do not operate this product at a higher temperature.
- In case of a serious operating problem, stop using this product immediately!



**In the unlikely event that your CHAUVET® product may require service, please contact CHAUVET® Technical Support.**

## Expected LED Lifespan

LEDs gradually decline in brightness over time, mostly because of heat. Packaged in clusters, LEDs exhibit higher operating temperatures than in ideal, single LED conditions. For this reason, using clustered LEDs at their fullest intensity significantly reduces the LEDs' lifespan. Under normal conditions, this lifespan can be of 40,000 to 50,000 hours. If extending this lifespan is vital, lower the operational temperature by improving the fixture's ventilation and reducing the external temperature. In addition, limiting the overall projection intensity may also help to extend the LEDs' lifespan.

## 2. Introduction

### Product Description

The COLORado™ 1 IP is an RGBW wash light based on 42 LEDs. It consists of a single pod with a double bracket mounting yoke. The AC power comes directly into the fixture's housing through a proprietary IP66 rated power input cord. The power linking uses a proprietary IP66 rated power link cord. The DMX input and output signals use proprietary IP66 DMX in and DMX out cords. The fixture comes with all the necessary adapters to connect to the proprietary IP66 cords as well a power and signal link cables. The COLORado™ 1 IP uses a display-based control panel for programming functions.

### Features

- 3, 4, 5, 6, or 11-channel RGBW LED wash light (with ID addressing)
- Operating modes:
  - 3-channel: RGB control
  - 3-channel: HSV (hue, saturation, and value) control
  - 4-channel: RGB, dimmer
  - 4-channel: RGBW control
  - 5-channel: RGBW, dimmer
  - 6-channel: RGBW, dimmer, strobe
  - 11-channel: RGBW, ID, dimmer, strobe, macro, auto/custom, dimmer speed, auto speed
- RGBW color mixing with or without DMX controller
- Automatic programs
- User configurable custom programs
- Recall auto and custom programs via master/slave or DMX
- Color temperature presets (3,200~10,000 K)

### Additional Features

- Five distinct dimming curves
- 3-pin DMX input and output connectors
- Power linking: max 12 units @ 120 V
- LED display with password protection
- Gel frame holder (4 mm max thickness)
- Double-bracket yoke that doubles as floor stand
- Color calibration
- Durable and weather resistant IP66 rated housing
- IP66 power and DMX connectors

### Options

- Optical systems: 15° (installed), 30° (CLENS3042)
- 16.4 ft (5 m) power extension cable (IP5POWER)
- 16.4 ft (5 m) signal extension cable (IP5SIG)

## DMX Channel Summary

	<b>DMX Channel</b>	<b>Function</b>
<b>TOUR</b>	1	Master Dimmer
	2	Red
	3	Green
	4	Blue
	5	White
	6	Color Macro
	7	Strobe
	8	Auto Programs
	9	Auto Speed Adjust
	10	Dimmer Speed
	11	ID Address
<b>ARC1</b>	<b>DMX Channel</b>	<b>Function</b>
	1	Red
	2	Green
<b>AR1 + D</b>	<b>DMX Channel</b>	<b>Function</b>
	1	Master Dimmer
	2	Red
	3	Green
<b>ARC2</b>	<b>DMX Channel</b>	<b>Function</b>
	1	Red
	2	Green
	3	Blue
<b>AR2 + D</b>	<b>DMX Channel</b>	<b>Function</b>
	1	Master Dimmer
	2	Red
	3	Green
	4	Blue
<b>AR2 + S</b>	<b>DMX Channel</b>	<b>Function</b>
	1	Master Dimmer
	2	Red
	3	Green
	4	Blue
	5	White
<b>HSV</b>	<b>DMX Channel</b>	<b>Function</b>
	1	Hue
	2	Saturation
	3	Value



Product Overview

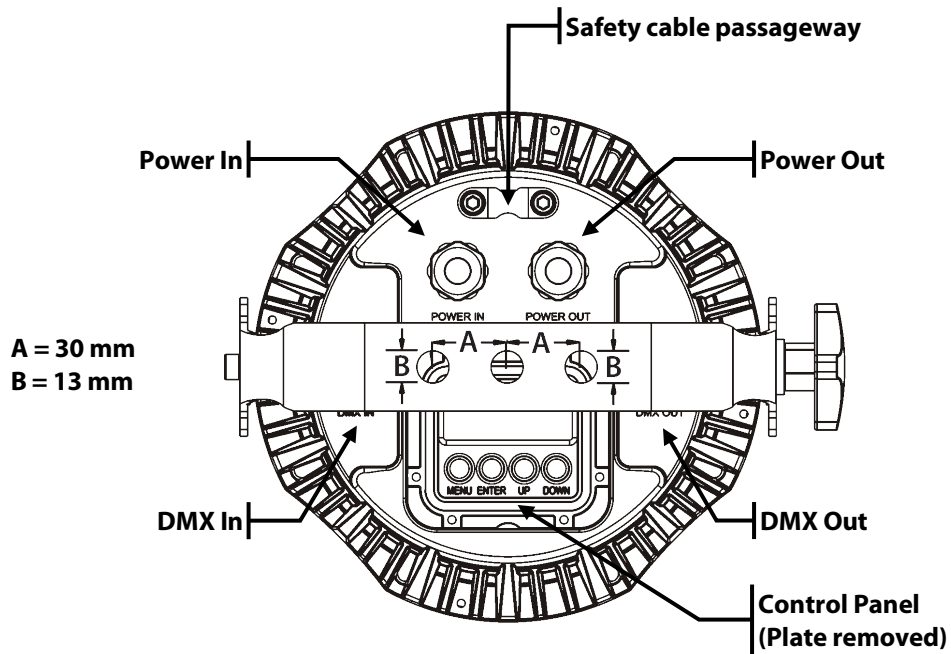
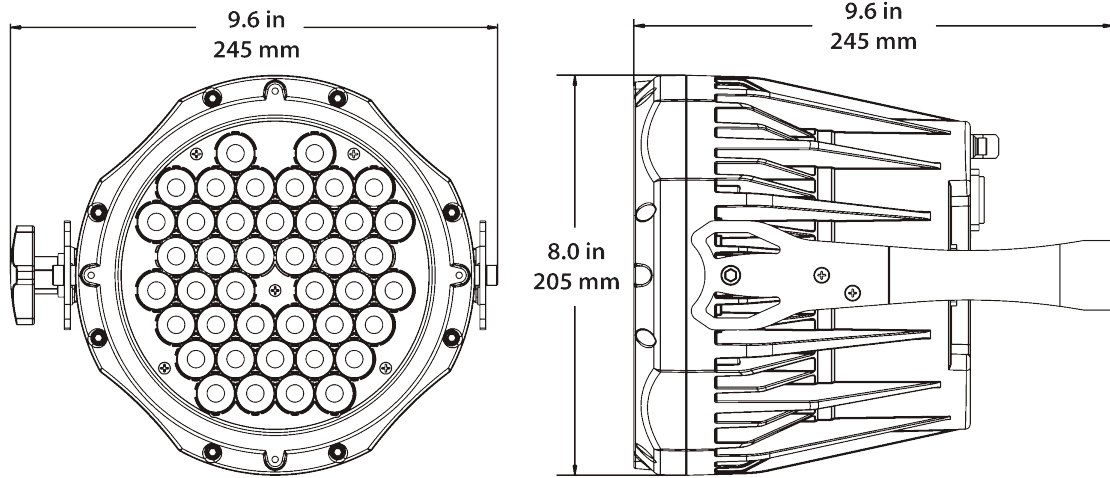

## 3. Setup

### AC Power

The COLORado™ 1 IP has an auto-ranging power supply that can work with an input voltage range of 100–240 VAC, 50/60 Hz.

Make sure that you are connecting this product to the proper voltage, as per the specifications in this guide, the product's user manual, or on the product's sticker.



**Always connect the COLORado™ 1 IP to a protected circuit with an appropriate electrical ground to avoid the risk of electrocution or fire.**

To determine the power requirements for the COLORado™ 1 IP see the label affixed to the side of the fixture. Alternatively, you may refer to the corresponding specifications chart in the *Technical Information* chapter of this manual.

The listed current rating indicates the maximum current draw during normal operation. For more information, you may download the “Sizing the Circuit Breakers” document from the CHAUVET® Web site.



**Never connect the COLORado™ 1 IP to a rheostat (variable resistor) or dimmer circuit, even if the rheostat or dimmer channel serves only as a 0 to 100% switch.**

### AC Plug

Each COLORado™ 1 IP has IP66 rated cords for Power In and Power Out with proprietary IP66 connectors. These power cords access the sealed body of the fixture through IP66 cable glands. To allow connection to power outlets, the fixture comes with a power input cord with a proprietary IP66 connector on one end and an Edison plug on the other end (US market). In case you need to replace the Edison plug on the power input cord, follow the table below.

Connection	Wire (US)	Wire (Europe)	IP66 Pin	Screw Color
AC Live	Black	Brown	1	Yellow or Brass
AC Neutral	White	Blue	2	Silver
AC Ground	Green/Yellow	Green/Yellow	3	Green

### Power Linking

The COLORado™ 1 IP supports power linking for up to 12 other COLORado™ 1 IP fixtures at 120 VAC. The fixture also comes with an IP66 power linking cord to allow direct connection between fixtures.

### Fuse Replacement

The COLORado™ 1 IP fixture has no external fuse that the user can change. However, it does have an internal fuse that only an authorized CHAUVET® technician should change.

### DMX Linking

You may link any COLORado™ 1 IP fixture to a DMX controller using a standard DMX serial connection. If using other DMX compatible fixtures with a COLORado™ 1 IP fixture, it is possible to control them individually with a single DMX controller.

If you are not familiar with the DMX standard, or if you need information about the DMX cables needed to link the COLORado™ 1 IP fixture to a DMX controller, you may download the “DMX Primer” document from the CHAUVET® Web site.



**The COLORado™ 1 IP comes with two adapter cables, one from proprietary IP66 to 3-pin DMX In and the other from proprietary IP66 to 3-pin DMX Out. In addition, it comes with a signal linking cable with proprietary IP66 connectors on both ends.**

### DMX Modes

The COLORado™ 1 IP uses the standard DMX data connection for its DMX modes, **TOUR, ARC1, AR1 + D, ARC2, AR2 + D, AR2 + S, and HSV.**

You will find information about these DMX modes in the *Introduction* chapter (brief description), the *Operation Instructions* chapter (configuration details), and the *DMX Values* section (individual channel values).

## Master/Slave Connectivity

The Master/Slave mode allows a COLORado™ 1 IP fixture to control one or more COLORado™ 1 IP fixtures without a DMX controller. The controlling fixture becomes the “master” when running an Auto or Custom program as well as when in STATIC mode. The controlled fixtures are the “slaves” and you must set them to “SLAVE” mode from their respective control panels. During the Master/Slave operation, the slave fixtures will operate in unison with the master fixture.

The master and slave fixtures link to each other using the standard DMX serial connection. If you are not familiar with the Master/Slave connectivity, you may download the “DMX Primer” document from the CHAUVET® Web site.



**DO NOT connect a DMX controller to the fixtures operating in Master/Slave mode. Otherwise, the signals from the DMX controller may interfere with the signals from the master unit.**



The *Operation* chapter of this manual provides detailed instructions on how to configure the Master and Slave units.

## ID Addressing

The COLORado™ 1 IP uses the ID Addressing feature to increase the number of addressable fixtures in the same DMX universe when in the **TOUR** personality. Refer to the *Operation* chapter in this manual to learn in detail how to configure the COLORado™ 1 IP fixtures when using ID Addressing. If you are not familiar with the various connection methods when using ID Addressing, you may download the “DMX Primer” document from the CHAUVET® Web site.

## Lens Replacement

The COLORado™ 1 IP comes with the 15° lens assembly pre-installed from the factory. However, there is an optional lens kit (**CLENS3042**) available as an accessory, which will alter the beam angle of the fixture to 30°.

Follow the instructions below to change or replace the LED lens assembly.



- a) **Disconnect the fixture from the AC power before opening it.**
- b) **This procedure gives you direct access to the LEDs, which are very fragile. Use maximum care when handling the lenses over the LED assembly.**



**The numbers in parenthesis in the procedure below correspond to the parts indicated in the *Exploded View* section of the *Technical Information* chapter.**

### Procedure

- a) Remove the gel frame holder by removing the four Phillips screws (not shown).
- b) Remove the front cover (1) by removing the eight Allen screws that hold it in place.
- c) Remove the rubber seal (2) and the glass cover (3). The rubber seal may be a separate ring or it may come mounted around the glass cover. Use caution, because the glass is loose under the front cover and it may fall.
- d) After removing the glass cover, remove the Phillips #2 screws that hold the lens assembly in place.
- e) Remove the existing lens assembly and replace it with the new lens assembly.
- f) Reverse the process to complete the lens replacement.



**After replacing the lenses, make sure that the fixture is completely sealed (IP66 rating) before installing it outdoors. Otherwise, you will void the fixture’s warranty and risk damaging the fixture permanently.**

## Mounting

Before mounting this fixture, read and follow the safety recommendations indicated in the *Safety Notes* section (page 2 of this manual).

### Orientation

Always mount this fixture in any safe position while making sure that there is adequate room around it for ventilation, configuration, and maintenance.

Make sure to mount this fixture away from any flammable material as indicated in the *Safety Notes* section.

### Rigging

The COLORado™ 1 IP consists of a sealed (IP66) housing with a double bracket mounting yoke. It has two DMX signal cables (DMX In/DMX Out), and two power cables (Power In/Power Out), all of them fitted with proprietary IP66 connectors.

CHAUVET® recommends following the general guidelines below when mounting the COLORado™ 1 IP.

- When selecting an installation location, consider ease of access to the fixture for operation, programming adjustments, and routine maintenance.
- If hanging this fixture, make sure that the location where you are mounting the fixture can support its weight. Please see the *Technical Specifications* section of this manual for the weight requirement of this fixture.

### Procedure

The COLORado™ 1 IP includes a safety cable and a mounting yoke to which you can attach one or two rigging clamps. You must supply your own “C” or “O” clamps and make sure that they are capable of supporting the weight of this fixture. Although it is possible to use a single clamp per fixture, CHAUVET® recommends using two clamps per fixture. Secure the fixture with the safety cable after mounting it to the truss.

Product Mounting  
Diagram

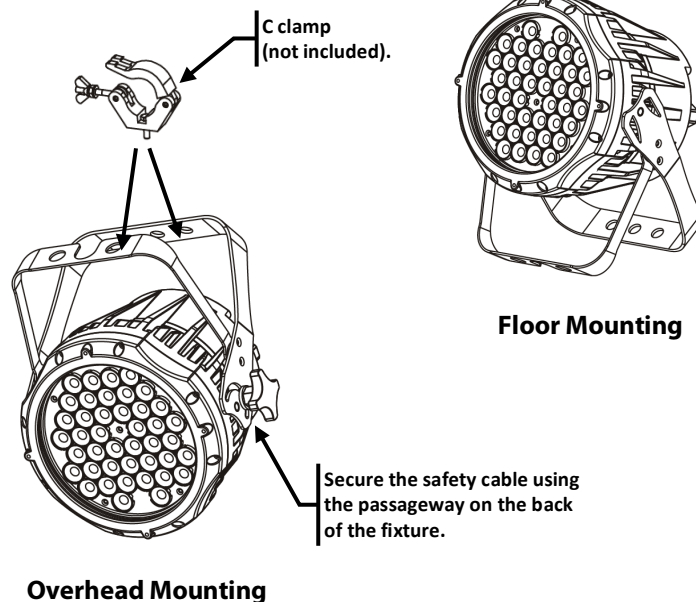

## 4. Operation

### Control Panel Description

Button	Function
<MENU>	Exits from the current menu or function
<ENTER>	Enables the currently displayed menu or sets the currently selected value in to the current function
<UP>	Navigates upwards through the menu list and increases the numeric value when in a function
<DOWN>	Navigates downwards through the menu list and decreases the numeric value when in a function

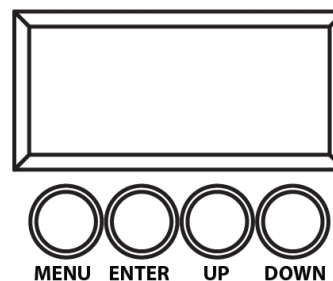

### Control Options

You can set the COLORado™ 1 IP start address in the 001~512 DMX range. This allows for the control of up to 46 fixtures in the 11-channel TOUR personality. In addition, the ID address system allows you to assign up to 66 fixtures within the same DMX address, thus multiplying the number of fixtures you can control within a single universe. You can access the fixture's ID address system from channel 11 when in the TOUR personality.



**When programming live performances as well as cues that need to trigger on demand or on a time line, program no more than 10 fixtures on ID addressing per DMX channel. This is to remain within a one-second execution time.**

### Programming

Carry out all the programming procedures indicated below from the control panel. Refer to the *Menu Map* on page 14 to learn how the menu options relate to each other.

To go to an option, press <MENU> repeatedly until the option shows on the display.

To select an option value, press <UP> or <DOWN> until you see the desired value and press <ENTER> to accept it.

To exit to the previous menu level, press <MENU>.

### DMX Personality

This setting allows the user to choose a particular DMX personality.

- 1) Go to **PERS**.
- 2) Select the desired personality (**TOUR**, **ARC1**, **AR1 + D**, **ARC2**, **AR2 + D**, **AR2 + S**, or **HSV**).
- 3) Make sure that the starting addresses on the various fixtures do not overlap due to the new personality setting. See the *DMX Values* section.

### DMX Control Without ID Addressing

In this mode, each unit will respond to a unique starting address from the DMX controller. All units with the same starting address will respond in unison.

- 1) Select the **TOUR** personality as shown in *DMX Personality*.
- 2) Set the running mode:
  - a) Go to **RUN**.
  - b) Select **DMX**.
- 3) Set the starting address:
  - a) Go to **DMX**.
  - b) Select the starting address (**001-512**).
- 4) Deactivate ID Addressing on each fixture:
  - a) Go to **SET > ID**.
  - b) Select **OFF**.



**Make sure to deactivate ID Addressing in each fixture when using the TOUR personality. Otherwise, unintended results may occur if channel 11 is not set to "0".**

Continues on the next page

Continued from previous page

### **DMX Control With ID Addressing**

In this mode, the fixtures with the same DMX starting address will respond to the DMX controller based on the fixture's individual ID address setting. If the user selects ID address "0", all the fixtures with the same DMX address will respond in unison. Otherwise, each fixture will follow the control for its particular ID address.

- 1) Repeat steps **1**, **2**, and **3** from *DMX Control Without ID Addressing*.
- 2) Activate ID Addressing in each fixture:
  - a) Go to **SET > ID**.
  - b) Select **ON**.
- 3) Select an ID address for each fixture:
  - a) Go to **ID**.
  - b) Select an ID (**01~66**)

### **Static Color**

The Static Color mode allows for permanent RGBW color mixing without a DMX controller.

- 1) Go to **STAT**.
- 2) Select the desired color (**Red, Green, Blue, or White**).
- 3) Select the desired color value (**0~255**).
- 4) Repeat for the other colors.
- 5) Select **Strob**.
- 6) Select the desired frequency (**0~20**).

### **Auto Programs**

Auto programs allow for dynamic RGBW color mixing without a DMX controller.

- 1) Go to **AUTO**.
- 2) Select the desired auto program (**AT. 01~10** or **PR. 01~10**).



**You cannot edit auto programs AT. 01~10. However you can edit PR. 01~10 (see *Edit Customs*).**

### **Edit Customs**

This setting allows for the programming of up to 30 scenes for each of the 10 customizable programs, including colors and effects.

- 1) Go to **EDIT**.
- 2) Select the desired auto program (**PR. 01~10**).
- 3) Select the desired scene (**SC. 01~30**).
- 4) Select the desired color or effect (**Red, Green, Blue, White, Strobe, Time, or Fade**).
- 5) Select the desired value for the color or effect (**000~255** for colors and timers, or **00~20** for Strobe).
- 6) Repeat for the other colors or effects.
- 7) Repeat for the other scenes.

### **Master/Slave**

The Master/Slave mode allows a group of COLORado™ 1 IP fixtures (the slaves) to execute simultaneously the same program, whether auto or custom, that another COLORado™ 1 IP fixture (the master) is executing, without a DMX controller.

- 1) Set the Master Unit:
  - a) Set the running mode to **DMX** as explained in "*DMX Control Without ID Addressing*".
  - b) Select an auto program as explained in "*Auto Programs*".
- 2) Set the slave units:
  - a) Go to **RUN**.
  - b) Select **SLAV**.



- **The fixture that runs an auto program automatically becomes the Master.**
- **Do not connect a DMX controller to the master or slave fixtures.**

Continues on the next page

Continued from previous page

### Color Adjustment

The **COLOR** setting determines how the COLORado™ 1 IP displays the white color when the Red, Green, and Blue faders are all at the “255” value.

- 1) Go to **SET > Color**.
- 2) Select **OFF**, **RGBW**, or **UC**.

Setting	Description
<b>OFF</b>	When R, G, and B are “255,” the output will be at its maximum.
<b>RGBW</b>	When R, G, and B are “255,” <b>CAL2</b> will determine the output.
<b>UC</b>	When R, G, and B are “255,” the output will match that of fixtures from previous generations.

### Dimmer Curves

This setting determines how the output of the COLORado™ 1 IP follows the position of the Dimmer fader, as well as the Red, Green, Blue, and White faders.

- 1) Go to **SET > Dim**.
- 2) Select a dimmer curve (**Off**, **Dim1**, **Dim2**, **Dim3**, or **Dim4**).

Setting	Description
<b>OFF</b>	The output is proportional to the faders’ position (linear)
<b>Dim1</b>	The output is not proportional (fastest)
<b>Dim2</b>	The output is not proportional (fast)
<b>Dim3</b>	The output is not proportional (slow)
<b>Dim4</b>	The output is not proportional (slowest)

### Control Panel Lock

This setting allows the user to activate or disable the control panel lock, which keeps non-authorized personnel from changing the fixture’s settings.

- 1) Go to **KEY**.
- 2) Select **On/ Off**.



**When the control panel lock is active, the fixture will prompt the user to enter the password after 30 seconds of control panel inactivity or after turning on the fixture.**

After being prompted to enter the password:

- 1) Press **<UP>**, **<DOWN>**, **<UP>**, **<DOWN>**, and **<ENTER>**.

### Program Upload

This option allows the user to copy the custom programs of one COLORado™ 1 IP fixture onto other COLORado™ 1 IP fixtures by using the Master/Slave method.

- 1) Configure and connect the fixtures in a Master/Slave arrangement, where the master unit has the custom programs you want to transfer onto the slave units.
- 2) At the master unit, go to **SET > UPLD**.
- 3) When prompted, enter the master access password as shown in *Control Panel Lock*.
- 4) Wait for the upload process to finish before disconnecting the fixtures.

During and after the upload, the master and slave units will visually indicate the status of the process, as follows:

Color	Meaning
<b>Yellow</b>	The upload process is running
<b>Red</b>	The upload failed due to an error
<b>Green</b>	The upload finished successfully

Continues on the next page

---

Continued from previous page

- Reset** This setting allows the user to reset the COLORado™ 1 IP fixture to its default values, including the custom programs.
- 1) Go to **SET> REST**.
  - 2) When prompted, enter the master access password as shown in *Control Panel Lock*.
  - 3) Wait for the reset process to finish.

- Whites Setting** This setting allows the user to edit the temperature of the 11 white colors used in the Macros channel. The 11 pre-set whites are configurable.
- 1) Go to **CAL1**.
  - 2) Select a white color (**WT. 1~11**).
  - 3) Select a color (**Red, Green, Blue, or White**).
  - 4) Select a color value (**0~255**).
  - 5) Repeat for the other colors (**Red, Green, Blue, or White**).
  - 6) Repeat for the other white colors (**WT. 1~11**).

- White Calibration** This setting allows the user to select the white color shown by the COLORado™ 1 IP when the color setting is **RGBW** and the Red, Green, and Blue faders are set to "255".
- 1) Go to **CAL2 > RGBW**.
  - 2) Select a color (**Red, Green, or Blue**).
  - 3) Select a color value (**0~255**).
  - 4) Repeat for the other colors (**Red, Green, or Blue**).



## TOUR Notes

These notes intent to clarify the way the TOUR DMX personality works.

### *Master Dimmer*

- Channel 1 controls the intensity of the currently projected color.
- When the slider is at the highest position (**255**) the intensity of the output is at its maximum.

### *Red, Green, Blue, & White Color Selection*

- Channels 2, 3, 4, and 5 control the intensity ratio of each of the Red, Green, Blue, and White LEDs.
- When the slider is at the highest position (**255**), the intensity of each color is at its maximum.
- You can combine channels 2, 3, 4, and 5 to create over four billion colors.

### *Color Macros*

- Channel 6 selects the required Color Macro.
- Channel 6 has priority over channels 2, 3, 4, and 5.
- Channel 1 controls the intensity of the Color Macro.

### *Strobe*

- Channel 7 controls the strobe frequency (not the intensity) of channels 2-6.
- Channel 7 strobos channels 2, 3, 4, and 5 when not running macros, allowing the individual faders (R, G, B, and W) as well as channel 1 (D) to control the output intensity.
- Channel 7 strobos channel 6 when running macros, allowing channel 6 to select the macro and channel 1 to control the output intensity.

### *Auto*

- Channel 8 selects the preset auto programs **AT. 01~10** or the custom programs **CUS. 01~10**.
- When activating the custom programs **CUS. 01~10**, it is possible to control the Step Time and Fade Time using channels 2 and 3 respectively.
- Channel 8 has priority over channels 2, 3, 4, 5, 6, and 7.

### *Dimmer Speed*

- Channel 10 is for selecting the dimmer mode and speed. When **Dimmer** is set to **Off**, the Red, Green, Blue, White, and Dimmer outputs are linear with the faders. Otherwise, **Dim1** is the fastest dimmer curve, while **Dim4** is the slowest.

### *ID Address Selection*

- Channel 11 selects the target ID address.
- Each independent DMX address may have up to 66 independent ID addresses.
- Setting channel 11 to **0** activates all ID address locations.

## Menu Map

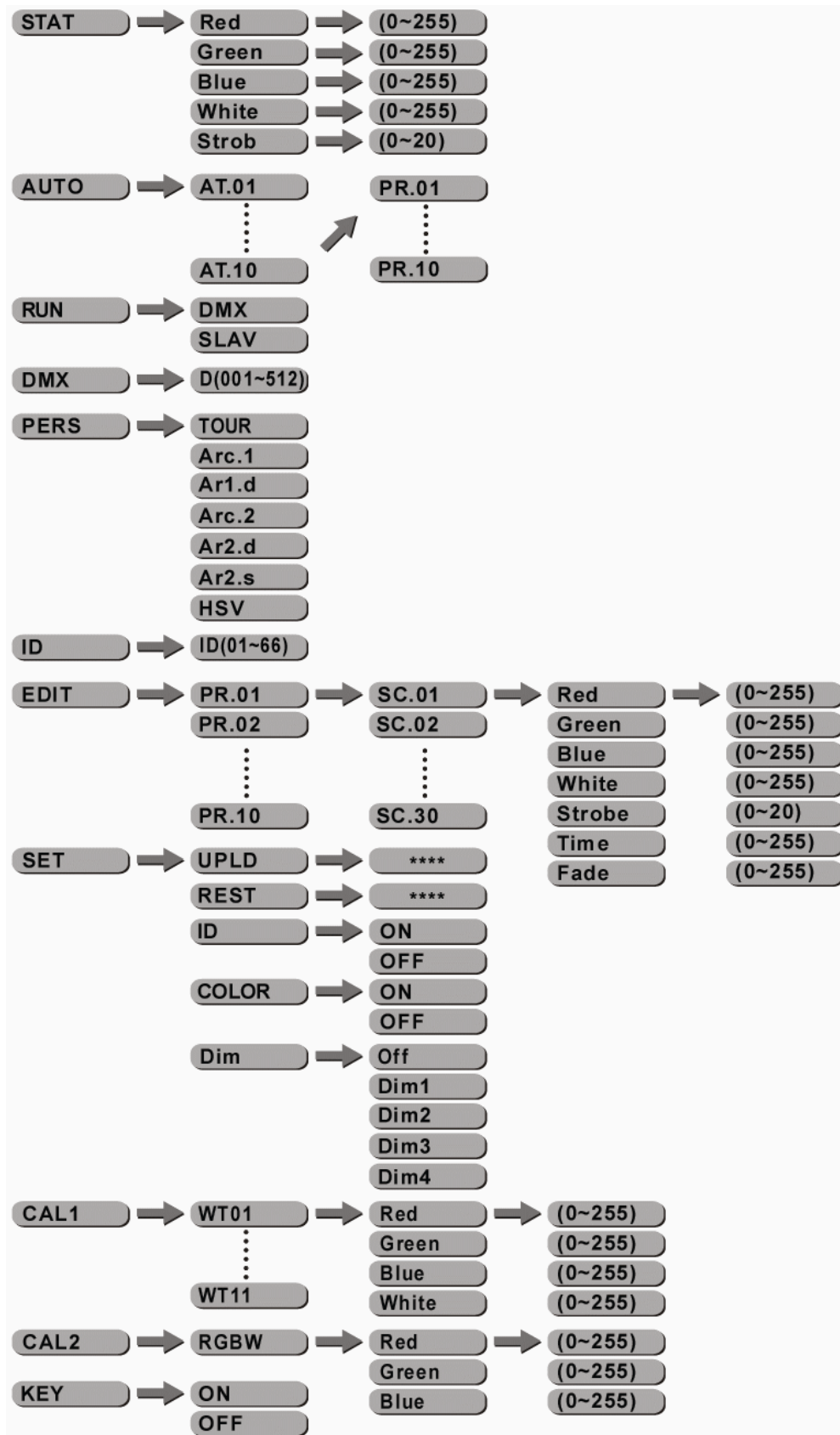

## DMX Values

<i>TOUR</i>	Channel	Function	Value	Percent/Setting
	1	Master Dimmer	000 ⇔ 255	0~100%
	2	Red	000 ⇔ 255	0~100% (or <b>Step Time</b> when playing CUS. 01~10)
	3	Green	000 ⇔ 255	0~100% (or <b>Fade Time</b> when playing CUS. 01~10)
	4	Blue	000 ⇔ 255	0~100%
	5	White	000 ⇔ 255	0~100%
	6	Color Macro	000 ⇔ 010	No function
			011 ⇔ 030	R: 100% G: Up B: 0%
			031 ⇔ 050	R: Down G: 100% B: 0%
			051 ⇔ 070	R: 0% G: 100% B: Up
			071 ⇔ 090	R: 0% G: Down B: 100%
			091 ⇔ 110	R: Up G: 0% B: 100%
			111 ⇔ 130	R: 100% G: 0% B: Down
			131 ⇔ 150	R: 100% G: Up B: Up
			151 ⇔ 170	R: Down G: Down B: 100%
			171 ⇔ 200	R: 100% G: 100% B: 100% W: 100%
			201 ⇔ 205	White 1: 3,200 K
			206 ⇔ 210	White 2: 3,400 K
			211 ⇔ 215	White 3: 4,200 K
			216 ⇔ 220	White 4: 4,900 K
			221 ⇔ 225	White 5: 5,600 K
			226 ⇔ 230	White 6: 5,900 K
	231 ⇔ 235	White 7: 6,500 K		
	236 ⇔ 240	White 8: 7,200 K		
	241 ⇔ 245	White 9: 8,000 K		
	246 ⇔ 250	White 10: 8,500 K		
	251 ⇔ 255	White 11: 10,000 K		
	7	Strobe	000 ⇔ 010	No function
			011 ⇔ 255	0~20 Hz
	8	Auto	000 ⇔ 020	No function
			021 ⇔ 030	Auto 1
			031 ⇔ 040	Auto 2
			041 ⇔ 050	Auto 3
			051 ⇔ 060	Auto 4
			061 ⇔ 070	Auto 5
			071 ⇔ 080	Auto 6
			081 ⇔ 090	Auto 7
			091 ⇔ 100	Auto 8
			101 ⇔ 110	Auto 9
			111 ⇔ 120	Auto 10
			121 ⇔ 130	Custom 1
			131 ⇔ 140	Custom 2
			141 ⇔ 150	Custom 3
			151 ⇔ 160	Custom 4
			161 ⇔ 170	Custom 5
	171 ⇔ 180	Custom 6		
	181 ⇔ 190	Custom 7		
	191 ⇔ 200	Custom 8		
	201 ⇔ 210	Custom 9		
	211 ⇔ 220	Custom 10		
	221 ⇔ 255	No function		
	9	Auto Speed	000 ⇔ 255	0~100% (Only works if AUTO 01~10 is playing)
	10	Dimmer Speed	000 ⇔ 009	Use dimmer speed from control panel
			010 ⇔ 029	Linear dimmer
			030 ⇔ 069	Non-linear dimmer 1 (fastest)
			070 ⇔ 129	Non-linear dimmer 2
			130 ⇔ 189	Non-linear dimmer 3
			190 ⇔ 255	Non-linear dimmer 4 (slowest)

Continues on the next page

Continued from previous page

<i>TOUR (Cont.)</i>	Channel	Function	Value	Setting	Value	Setting	Value	Setting
	11	ID Address	000 ⇄ 009	All IDs	212	ID 23	235	ID 46
			010 ⇄ 019	ID 1	213	ID 24	236	ID 47
			020 ⇄ 029	ID 2	214	ID 25	237	ID 48
			030 ⇄ 039	ID 3	215	ID 26	238	ID 49
			040 ⇄ 049	ID 4	216	ID 27	239	ID 50
			050 ⇄ 059	ID 5	217	ID 28	240	ID 51
			060 ⇄ 069	ID 6	218	ID 29	241	ID 52
			070 ⇄ 079	ID 7	219	ID 30	242	ID 53
			080 ⇄ 089	ID 8	220	ID 31	243	ID 54
			090 ⇄ 099	ID 9	221	ID 32	244	ID 55
			100 ⇄ 109	ID 10	222	ID 33	245	ID 56
			110 ⇄ 119	ID 11	223	ID 34	246	ID 57
			120 ⇄ 129	ID 12	224	ID 35	247	ID 58
			130 ⇄ 139	ID 13	225	ID 36	248	ID 59
			140 ⇄ 149	ID 14	226	ID 37	249	ID 60
			150 ⇄ 159	ID 15	227	ID 38	250	ID 61
			160 ⇄ 169	ID 16	228	ID 39	251	ID 62
			170 ⇄ 179	ID 17	229	ID 40	252	ID 63
			180 ⇄ 189	ID 18	230	ID 41	253	ID 64
			190 ⇄ 199	ID 19	231	ID 42	254	ID 65
			200 ⇄ 209	ID 20	232	ID 43	255	ID 66
				210	ID 21	233	ID 44	
		211	ID 22	234	ID 45			

<i>ARC1</i>	Channel	Function	Value	Percent/Setting
	1	Red	000 ⇄ 255	0~100%
	2	Green	000 ⇄ 255	0~100%
	3	Blue	000 ⇄ 255	0~100%

<i>ARC1 + D</i>	Channel	Function	Value	Percent/Setting
	1	Master Dimmer	000 ⇄ 255	0~100%
	2	Red	000 ⇄ 255	0~100%
	3	Green	000 ⇄ 255	0~100%
	4	Blue	000 ⇄ 255	0~100%

<i>ARC2</i>	Channel	Function	Value	Percent/Setting
	1	Red	000 ⇄ 255	0~100%
	2	Green	000 ⇄ 255	0~100%
	3	Blue	000 ⇄ 255	0~100%
	4	White	000 ⇄ 255	0~100%

<i>ARC2 + D</i>	Channel	Function	Value	Percent/Setting
	1	Master Dimmer	000 ⇄ 255	0~100%
	2	Red	000 ⇄ 255	0~100%
	3	Green	000 ⇄ 255	0~100%
	4	Blue	000 ⇄ 255	0~100%
	5	White	000 ⇄ 255	0~100%

Continues on the next page

Continued from previous page

<b>ARC2 + S</b>	Channel	Function	Value	Percent/Setting
	1	Master Dimmer	000 ⇄ 255	0~100%
	2	Red	000 ⇄ 255	0~100%
	3	Green	000 ⇄ 255	0~100%
	4	Blue	000 ⇄ 255	0~100%
	5	White	000 ⇄ 255	0~100%
	6	Strobe	000 ⇄ 010 011 ⇄ 255	No function 0~20 Hz

<b>HSV</b>	Channel	Function	Value	Percent/Setting
	1	Hue	000 ⇄ 255	0~100%
	2	Saturation	000 ⇄ 255	0~100%
	3	Value	000 ⇄ 255	0~100%



- *“Hue” refers to the visible light, such as red, yellow, and cyan, etc.*
- *“Saturation” indicates the dominance of hue in the color; when saturation is at 100%, the color is at its purest.*
- *“Value” is the color’s brightness; when value is at 100%, the color is at its brightest.*

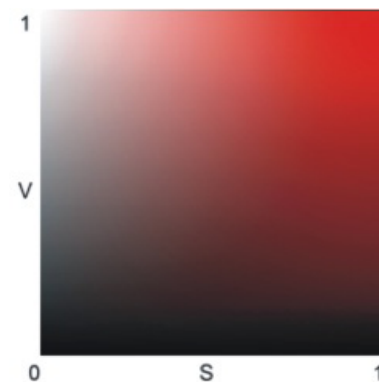
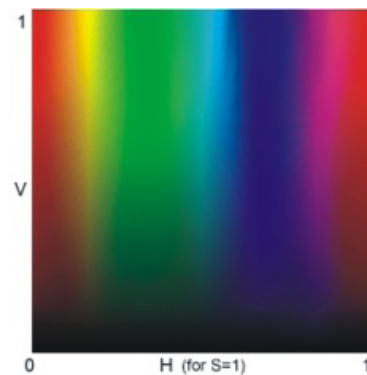

## 5. Technical Information

### General Maintenance

To maintain optimum performance and minimize wear, the user should clean the light fixtures frequently. Usage and environment are contributing factors in determining the cleaning frequency. As a rule, the user should clean the fixtures at least twice a month. Dust build up reduces light output performance and can cause overheating. This can lead to reduced light source life and increased mechanical wear.

CHAUVET® recommends cleaning the fixture's external optics with a soft cloth using normal glass cleaning fluid.

To clean a fixture, follow the recommendations below:

- Unplug the fixture from power.
- Wait until the fixture is cold.
- Use a vacuum (or dry compressed air) and a soft brush to remove dust collected on the external vents and reachable internal components.
- Clean all external optics and glass surfaces with a mild solution of glass cleaner or isopropyl alcohol, and a soft, lint free cotton cloth or a lens cleaning tissue.
- Apply the solution directly to the cloth or tissue and drag any dirt and grime to the outside of the lens.
- Gently polish the external glass surfaces until they are free of haze and lint.
- When cleaning units with a movable mirror, you should keep the contact with the mirror surface to a minimum to avoid scratching or damaging it.



**Always dry the external optics and glass surfaces carefully after cleaning them.**



**If the fixture has one or more cooling fans, refrain from spinning them using compressed air.**

## Troubleshooting Guide

Symptom	Cause(s)	Action(s)
General low light intensity	<ul style="list-style-type: none"> <li>• Dirty lens assembly</li> <li>• Misaligned lens assembly</li> </ul>	<ul style="list-style-type: none"> <li>• Clean the fixture regularly</li> <li>• Install lens assembly properly</li> </ul>
A single LED (Red, Green, Blue or White) does not illuminate	<ul style="list-style-type: none"> <li>• Faulty LED</li> <li>• Faulty LED board</li> </ul>	<ul style="list-style-type: none"> <li>• Replace the LED board</li> <li>• Replace the LED board</li> </ul>
A group of LEDs (Red, Green, Blue or White) does not illuminate	<ul style="list-style-type: none"> <li>• Faulty LED</li> <li>• Faulty LED board</li> <li>• Faulty LED driver</li> </ul>	<ul style="list-style-type: none"> <li>• Replace the LED board</li> <li>• Replace the LED board</li> <li>• Replace the LED driver board</li> </ul>
None of the LEDs are illuminating	<ul style="list-style-type: none"> <li>• Faulty LED PCB</li> <li>• Faulty LED Driver PCB</li> <li>• Faulty main PCB</li> </ul>	<ul style="list-style-type: none"> <li>• Replace the LED board</li> <li>• Replace the LED driver board</li> <li>• Replace the Display / Main board</li> </ul>
Breaker/Fuse keeps blowing	<ul style="list-style-type: none"> <li>• Excessive circuit load</li> <li>• Short circuit along the power wires</li> </ul>	<ul style="list-style-type: none"> <li>• Check total load placed on the electrical circuit</li> <li>• Check for a short in the electrical wiring</li> </ul>
Fixture does not power up	<ul style="list-style-type: none"> <li>• No power</li> <li>• Loose or damaged power cord</li> <li>• Blown internal fuse</li> <li>• Faulty internal power supply</li> </ul>	<ul style="list-style-type: none"> <li>• Check for power on power outlet</li> <li>• Check power cord</li> <li>• Replace internal fuse</li> <li>• Replace internal power supply</li> </ul>
Fixture does not respond to DMX	<ul style="list-style-type: none"> <li>• Wrong DMX addressing</li> <li>• Damaged DMX cables</li> <li>• Wrong polarity on the controller</li> <li>• Loose DMX cables</li> <li>• Faulty DMX interface</li> <li>• Faulty Main PCB</li> </ul>	<ul style="list-style-type: none"> <li>• Check Control Panel and unit addressing</li> <li>• Check DMX cables</li> <li>• Check polarity switch settings on the controller</li> <li>• Check cable connections</li> <li>• Replace Main PCB</li> <li>• Replace Main PCB</li> </ul>
DMX signal problems	<ul style="list-style-type: none"> <li>• Non DMX cables</li> <li>• Bouncing signals</li> <li>• Long cable / low level signal</li> <li>• Too many fixtures</li> <li>• Interference from AC wires</li> </ul>	<ul style="list-style-type: none"> <li>• Use only DMX compatible cables</li> <li>• Install terminator as suggested</li> <li>• Install an optically coupled DMX splitter right after fixture with strong signal</li> <li>• Install an optically coupled DMX splitter after unit #32</li> <li>• Keep DMX cables separated from power cables or black lights</li> </ul>



If you still experience technical problems after trying the above solutions, contact CHAUVET® Technical Support.

## Exploded View

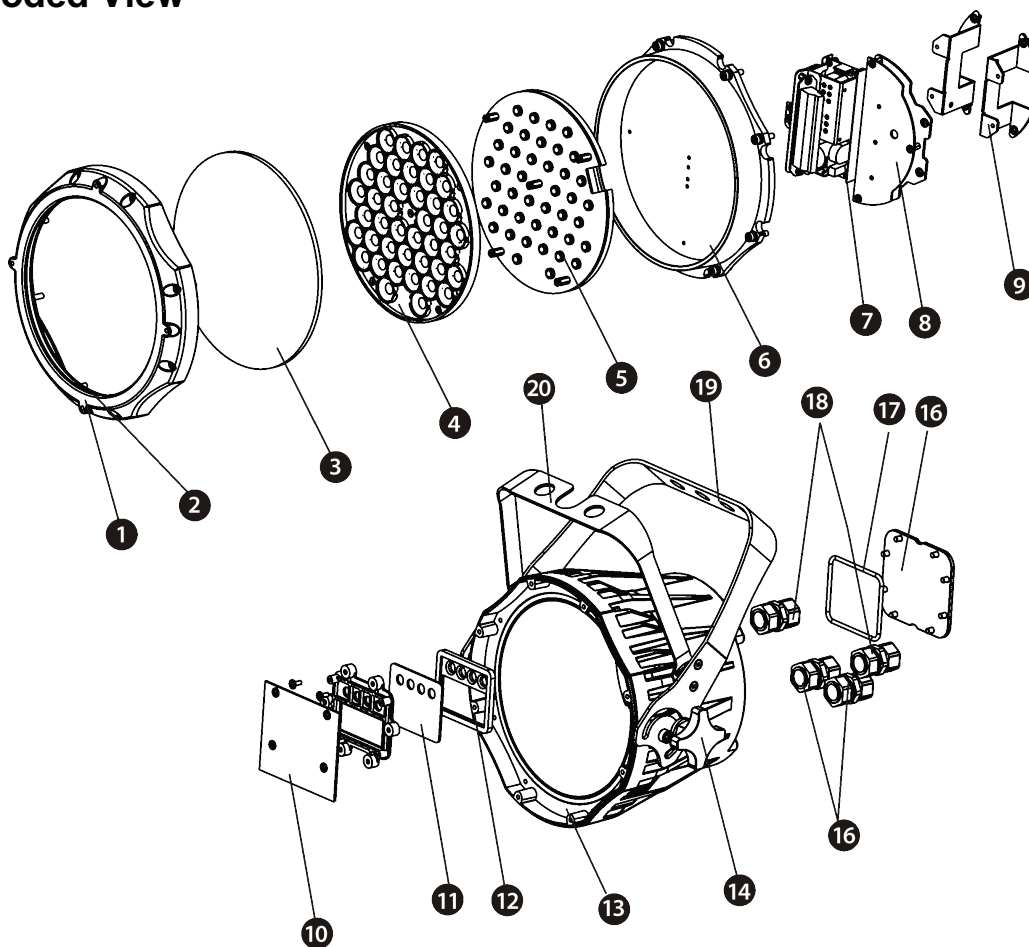

Item	Description	Item	Description
1	Front cover	11	Display clear plate
2	Rubber seal (*)	12	Button seal
3	Clear glass	13	Casing
4	Lens complete set	14	Stainless steel knob
5	LED board	15	Power cord gland
6	Heat sink	16	Display protection plate
7	Power supply	17	DMX cable gland
8	Driver board	18	Display plate seal
9	Power connection board	19	Main bracket
10	Display board	20	Secondary bracket

(\*): The rubber seal can be a separate ring or it may come mounted around the glass cover



## Photometrics

## Red

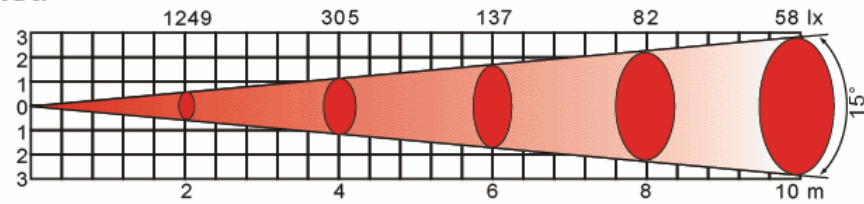

## Green

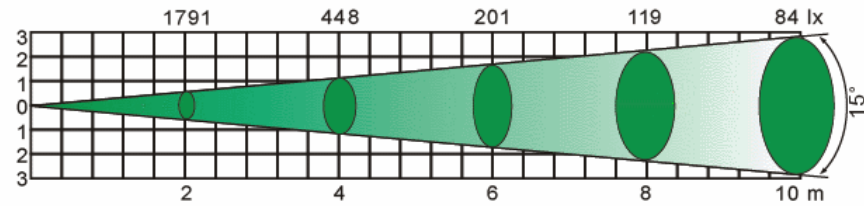

## Blue

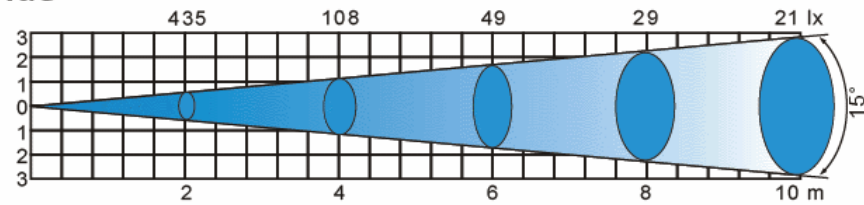

## White

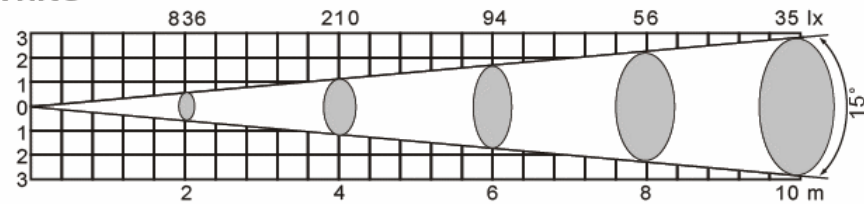

## RGB

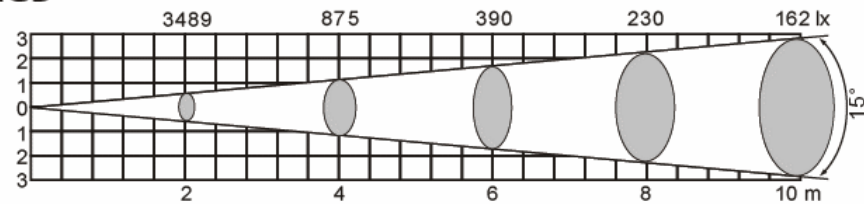

## RGB + White

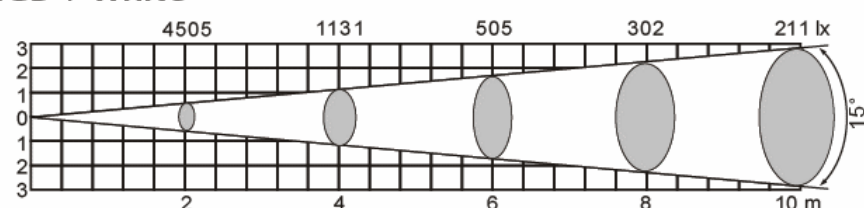

## Returns Procedure

The user must send the merchandise prepaid, in the original box, and with its original packing and accessories. CHAUVET® will not issue call tags.

Call CHAUVET® and request a Return Merchandise Authorization Number (RMA #) before shipping the fixture. Be prepared to provide the model number, serial number, and a brief description of the cause for the return.

The user must clearly label the package with a Return Merchandise Authorization Number (RMA #). CHAUVET® will refuse any product returned without an RMA #.



**DO NOT write the RMA # directly on the box. Instead, write it on a properly affixed label.**

Once you receive the RMA #, please include the following information on a piece of paper inside the box:

- Your name
- Your address
- Your phone number
- The RMA #
- A brief description of the problem

Be sure to pack the fixture properly. Any shipping damage resulting from inadequate packaging will be the customer's responsibility. As a suggestion, proper UPS packing or double-boxing is always a safe method to use.



**CHAUVET® reserves the right to use its own discretion to repair or replace returned product(s).**

## Claims

The carrier is responsible for any damage incurred during shipping to this product or any part that shipped with it. Therefore, if the received merchandise appears to have damages caused during shipping, the customer must submit the damage report and any related claims with the carrier, not CHAUVET®. The customer must submit the report upon reception of the damaged merchandise. Failure to do so in a timely manner may invalidate the customer's claim with the carrier.

For other issues such as missing components or parts, damage not related to shipping, or concealed damage, the customer must make claims to CHAUVET® within seven (7) days of receiving the merchandise.

## Contact Us

### World Headquarters

#### *General Information*

CHAUVET®  
 5200 NW 108th Avenue  
 Sunrise, FL 33351  
 Voice: (954) 929-1115  
 Fax: (954) 929-5560  
 Toll free: (800) 762-1084

#### *Technical Support*

Voice: (954) 929-1115 (Press 4)  
 Fax: (954) 756-8015

#### *World Wide Web*

[www.chauvetlighting.com](http://www.chauvetlighting.com)

## Technical Specifications

### Dimensions and Weight

Length	Width	Height	Weight
9.6 in (245 mm)	9.6 in (245 mm)	8.0 in (205 mm)	10.6 lbs (4.8 kg)

**Note:** Dimensions in inches rounded to the nearest decimal digit.

### Power

Power Supply Type	Range	Voltage Selection
Switching (internal)	100~240 V, 50/60 Hz	Auto-ranging

Parameter	120 V, 60 Hz	230 V, 50 Hz
Consumption	70 W (0.58 A)	70 W (0.3 A)
Inrush current	0.2 A	0.4 A
Power Linking	12 Units	24 Units

Power I/O	Input	Output
Connectors	IP66	IP66
Cord plug	Edison	IP66

### Light Source

Type	Power	Lifespan
LED	1 W	50,000 hours

Color	Quantity	Current
Red	12	350 mA
Green	12	350 mA
Blue	12	350 mA
White	6	350 mA

### Photo Optic

Parameter	Standard 15° Optics	Optional 30° Optics
Illuminance @ 5 m	664 lx	123 lx
Beam angle	13°	27°
Field angle	32.6°	59.9°

### Thermal

Maximum External Temp.	Cooling System
104° F (40° C)	Convection

### DMX

I/O Connectors	Connector Type	Channel Range
3-pin XLR (IP66 adapter)	In-line	3, 4, 5, 6, and 11

### Ordering

COLORado™ 1 IP	Optional 30° Optics
COLORADO1IP	CLENS3042

Signal Extension Cable	Power Extension Cable
IP5SIG	IP5POWER



CONFORMS TO  
UL STD. 1573  
CERTIFIED TO  
CSA STD. C22.2  
No. 166

3144482

---

**CHAUVET®**  
5200 NW 108th Avenue  
Sunrise, FL 33351 (USA)  
(800) 762-1084 – (954) 929-1115  
FAX (954) 929-5560  
[www.chauvetlighting.com](http://www.chauvetlighting.com)

COLORado™ 1 IP User Manual Rev. 01c  
October 2010



*It's Green Thinking*

## Free Manuals Download Website

<http://myh66.com>

<http://usermanuals.us>

<http://www.somanuals.com>

<http://www.4manuals.cc>

<http://www.manual-lib.com>

<http://www.404manual.com>

<http://www.luxmanual.com>

<http://aubethermostatmanual.com>

Golf course search by state

<http://golfingnear.com>

Email search by domain

<http://emailbydomain.com>

Auto manuals search

<http://auto.somanuals.com>

TV manuals search

<http://tv.somanuals.com>