

1991 MODELS

Wood Pellet Stoves

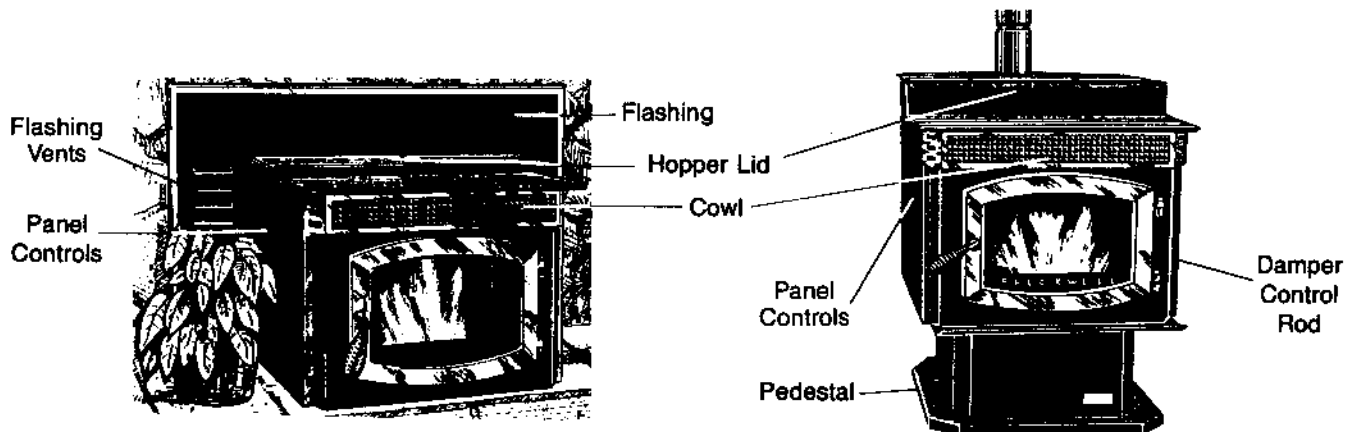

B R E C K W E L L



OWNERS MANUAL

Manufactured by
National Steelcrafters of Oregon, Inc.
P.O. Box 2501
Eugene, Oregon 97402

MODEL P24I Fireplace Insert
MODEL P24FS Freestanding Stove

SAFETY NOTICE: If your appliance is not properly installed a house fire may result. For your safety, follow the installation directions. Contact local building or fire officials about restrictions and installation inspection requirements in your area.

ALL UNITS TESTED AND LISTED BY

I.C.B.O. TL-128



NVLA
accredited

©NATIONAL STEELCRAFTERS
OF OREGON, INC.
1990

Thank you for purchasing the Breckwell Pellet Burning Stove. You are now prepared to burn wood in the most efficient, convenient way possible. To achieve the safest, most efficient and most enjoyable performance from your stove, you must do three things; 1) Install it properly 2) Operate it cor-

rectly and 3) Maintain it regularly. The purpose of this manual is to help you do all three. **PLEASE read this manual thoroughly before beginning your installation and KEEP IT in a handy place for future reference and future owners.**

CONTENTS

1.0 Introduction	3.0 Operation	4.0 Maintenance
2.0 Installation	3.1 Proper Fuel	4.1 Ash Disposal
2.1 Clearances	3.2 Pre-Startup Check	4.2 Firebox Cleaning
2.2 Combustion Air Supply	3.3 Building A Fire	4.3 Blowers
2.3 Venting	3.4 Panel Controls	4.4 Chimney Cleaning
2.31 P24FS Installation	3.5 Optional Thermostat	5.0 Trouble Shooting Guide
2.32 P24I Installation	3.6 Damper Control	5.1 Fuel Will Not Feed
2.4 Electrical Installation	3.7 Refueling	5.2 Fire Goes Out
2.5 Special Mobile Home Requirements	3.8 Breckwell Tools	5.3 Smokey Fire
	3.9 Shut Down Procedure	5.4 Pellet Feed Rate Varies From Setting
	3.91 Safety Features	5.5 No Power
	3.92 Operating Safety Precautions	5.6 Blowers Will Not Operate Properly
		5.7 Noisy Operation
		6.0 Replacement Parts List

1.0 INTRODUCTION

This stove has been independently tested and approved in accordance with the specifications and procedures outlined in Underwriters' Laboratories, Inc., standards for safety UL 1482, UL 907 solid fuel type room heaters, April 1987, and HUD requirements for installation as a stove heater and insert for masonry or metal fireplaces, plus Oregon new rules for mobile homes (814-23-900 through 814-23-909).

This appliance is designed specifically for use only with pelletized wood. It is approved for residential installation according to current national and local building codes as a free standing room heater, as an insert, and as a zero clearance (with header in place), when installed on the hearth of a masonry or metal fireplace. It is also approved as a mobile home heater

which is designed for connection with an outside air source.

The stove will not operate using natural draft, or without a power source for the blower systems and fuel feeding systems and must not be burned with any coal type of artificial fuels.

This stove is designed to provide the optimum proportions of fuel to air to the fire and will burn free of smoke and soot. Any blockage of the air supply to or from the stove will seriously degrade the performance and will be evidenced by a smoking exhaust and a sooting window. For the best operation the ash content of the pellet fuel should be less than 1% and the calorific value approximately 8200 BTU/LB. Avoid high ash content fuels as this will rapidly fill up the burn pot and eventually cut off the combustion air supply.

2.0 INSTALLATION

The Breckwell P24I has been tested and listed for installation into masonry fireplaces and factory-built "zero-clearance" fireplaces of the following description: all brands at least 30" wide and 20" high.

Also into mobile home factory built fireplaces of the following description: all brands at least 30" wide and 20" high.

The Breckwell P24FS has been tested and listed for installation in residential, mobile home, and alcove applications.

2.1 Clearances (figure 1)

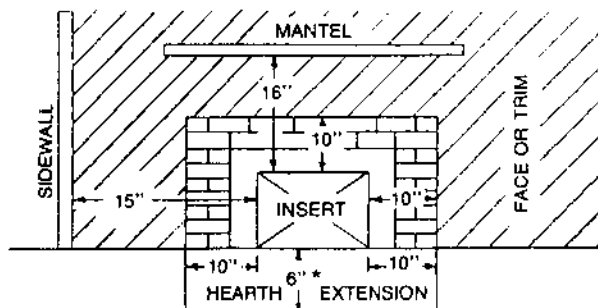

* On raised hearth installations, this may be reduced 1" for each 2" of rise of hearth. We recommend fire rated hearth carpet.

P24FS CLEARANCE TO COMBUSTIBLES

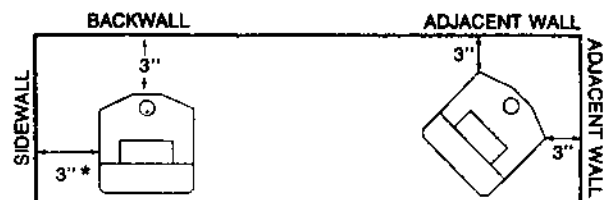

* Need 5" for damper throw

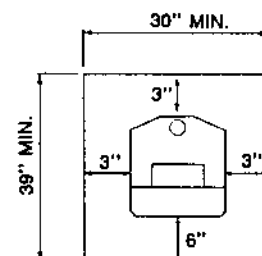

FIGURE 1

2.2 Combustion Air Supply

For mobile home installation the stove must be connected to an outside source of combustion air. A 1 $\frac{3}{4}$ " inside diameter metallic pipe, either flexible or rigid should be used when outside air is to be connected. It attaches to an outlet on the stove's rear (see figure 2) and its terminus should have a wind hood or be turned 90° to prevent back draft. It should also terminate with a rodent guard. If outside air is not provided, air should NOT be restricted to the combustion air inlet. Hence in P241 installations, flashing vents should be allowed to provide air to the fireplace cavity. The fireplace opening should not be sealed at the face.

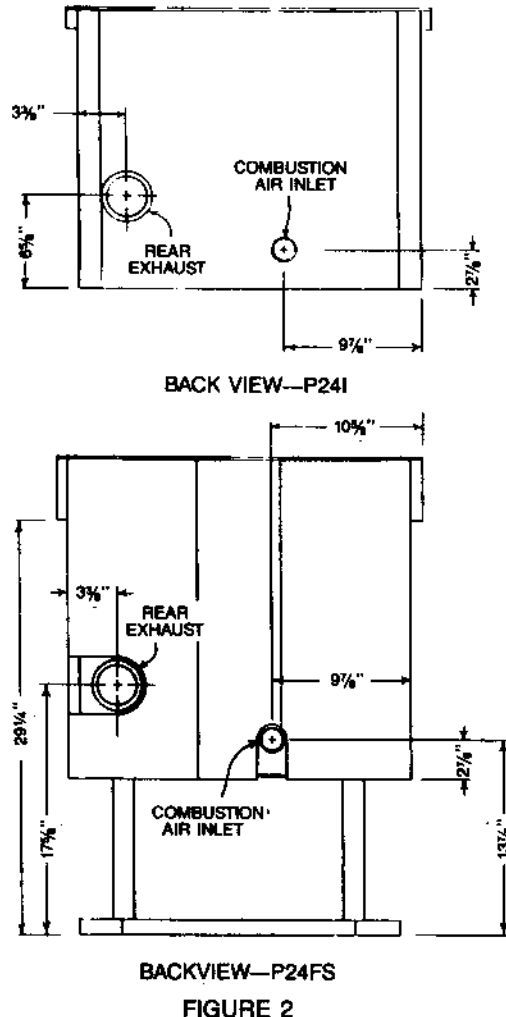

FIGURE 2

Sources of Outside Combustion Air

A. Fireplaces

1. Ash cleanout door on exterior wall.
2. Hole drilled in rear wall of firebox when fireplace is on an exterior wall (masonry fireplace only).
3. Top of chimney (see figure 6). All factory built fireplaces requiring outside air must use this method.
4. Within chimney above vent terminus.

B. Freestanding Stoves

1. Hole in floor to accommodate outside air pipe.
2. Hole in rear wall to accommodate outside air pipe.

2.3 Venting

Both Breckwell models are approved for 3" diameter vent. 4" diameter may be used as well. Class "A" chimney is not required.

2.31 P24FS INSTALLATIONS

Venting should be with 3" or 4" diameter pellet vent (L-Vent) chimney. Stove was tested with Simpson Duravent Brand. Refer to the instructions provided by the chimney manufacturer, especially when passing through a wall, ceiling, or roof. Model P24FS is designed for rear exhaust but can be changed to top exhaust with use of "Breckwell Vertical Installation Kit". See instructions with kit.

2.311 P24FS REAR EXHAUST INSTALLATION Horizontally Through Wall

1. Position stove, adhering to clearances shown in section 2.1.
2. Locate position of hole in wall, directly behind stove's exhaust vent (see figure 2).
3. Cut opening in wall, 9 $\frac{5}{8}$ " round for 3" L-Vent, 10 $\frac{5}{8}$ " round for 4" L-Vent. This provides space for thimble which fits between wall studs. Attach thimble.
4. Attach enough pipe to penetrate and extend at least 3" beyond exterior walls.
5. Attach cap and seal outside wall thimbles with non-hardening waterproof mastic.

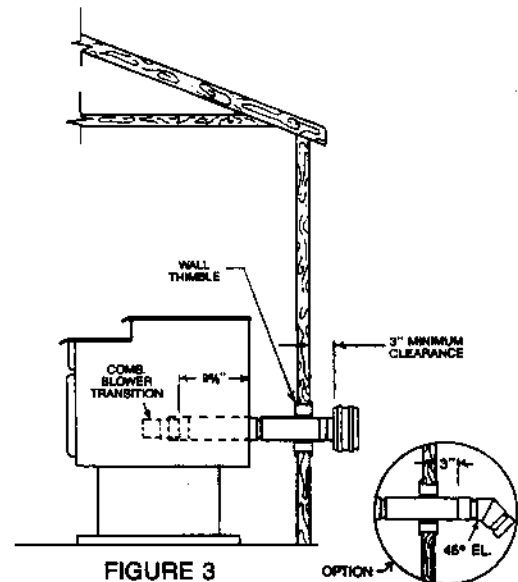

FIGURE 3

2.312 P24FS VERTICAL INSTALLATION New Chimney System (see figure 4)

NOTE: Follow L-Vent Chimney manufacturer's instructions.

1. Install "Vertical Installation Kit" to stove.
2. Locate stove, drop plumb bob to center of appliance flue outlet, mark center point on ceiling. Cut square hole in ceiling, for firestop support assembly (for 3", cut 9 $\frac{5}{8}$ " square; 4", cut 10 $\frac{5}{8}$ " square).
3. Connect chimney sections from stove upwards.
4. When pipe passes through firestop at ceiling, tighten bolt and clamp around pipe.
5. Always maintain 3" clearance from combustible materials. When passing through additional floors or ceilings always install firestop spacer.
6. After lining up for hole in roof, cut either round or square hole in roof, always 3" larger all the way around pipe. Install upper edge and sides of flashing under roofing materials, nail to the roof along upper edge. Do not nail lower edge. Seal nail heads with non-hardening water proof mastic.
7. Apply non-hardening, waterproof mastic where the storm collar will meet the vent and flashing, slide storm collar down until it sets on the flashing and put cap on, twist to lock.

2.313 P24FS VERTICAL INSTALLATION Existing Chimney System (figure 5)

Install "Vertical Installation Kit" to stove. Follow instructions in kit. Adapters are available to adjust from 3" to 6" or 8". As an alternative, 3" or 4" pipe can be run inside existing chimney.

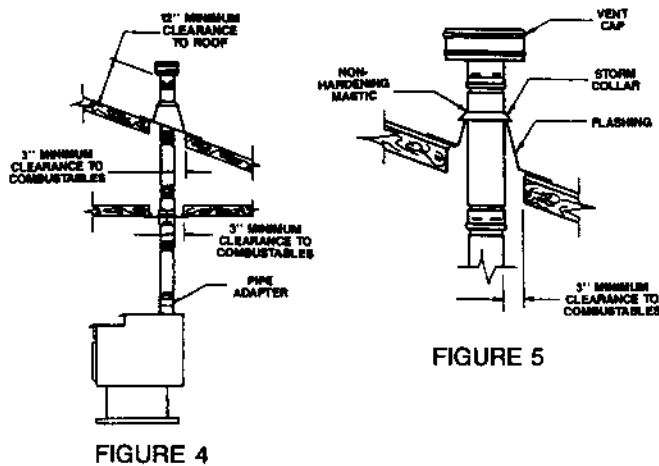

FIGURE 5

2.32 P24I INSTALLATIONS

Insert installations must be vented with 3" or 4" pipe (see figure 6). Pipe may be single wall stainless steel flexible pipe. Vent may terminate within chimney beyond a blanking plate or extend to the chimney top. See section 2.2 for outside air access information. In zero-clearance fireplace installations, when the fireplace opening is above the floor or raised hearth, the stove's front can be supported by threading two 3/8" bolts into holes under the front corners.

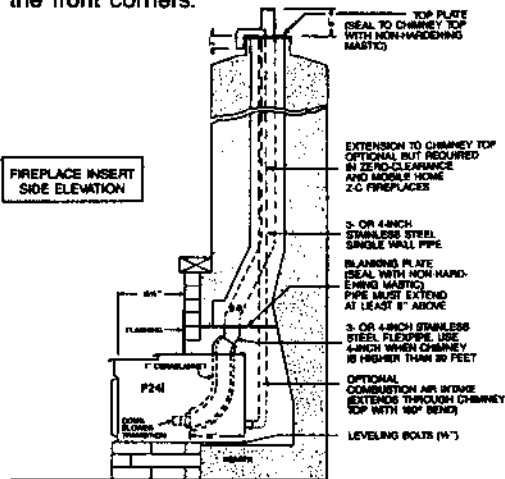

FIGURE 6

PROCEDURE NOTE: Follow metal chimney manufacturer's instructions.

2.321 WHEN VENT PIPE EXTENDS TO CHIMNEY TOP

1. You will need a pipe length equal to the chimney height (from hearth) plus one foot. If outside combustion air is to be used, you will need a pipe length (see section 2.2) equal to the chimney height less six inches.
2. Attach cerablanket wrap, which comes with stove, to that end of vent pipe that will connect to stove.
3. Set insert on hearth, adjust leveling bolts on rear sides, slide in far enough to attach vent pipe (and combustion air pipe if used). Use RTV, metallic tape, and/or self-tapping screws to assure tight connection.

4. Attach flashing, route power cord out the side nearest a 110V receptacle. Slide in insert. Seal is not necessary. Do not restrict air to or from vents in flashing.
5. Measure and build chimney top. Cut out holes for vent pipe (and combustion air pipe if used). Install and seal with non-hardening mastic to prevent water leakage. Install vent cap.

2.322 WHEN VENT PIPE EXTENDS THROUGH CHIMNEY BLANKING PLATE

1. You will need a pipe length equal to the hearth to blanking plate height plus six inches. An outside combustion air pipe (if used) must extend at least a foot above the vent pipe.

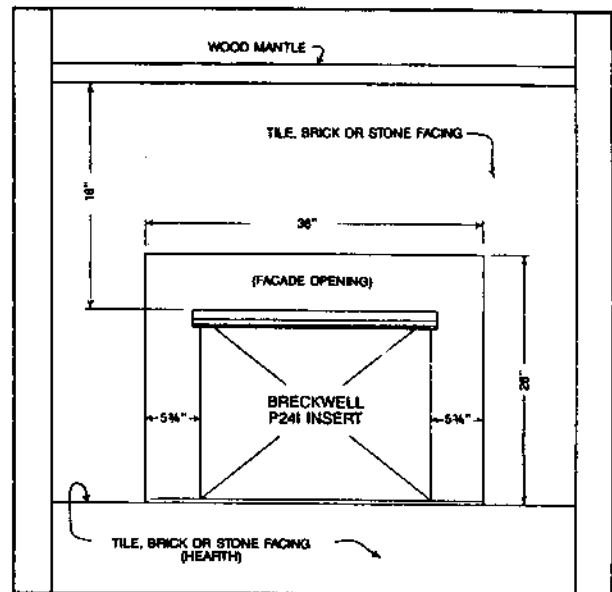
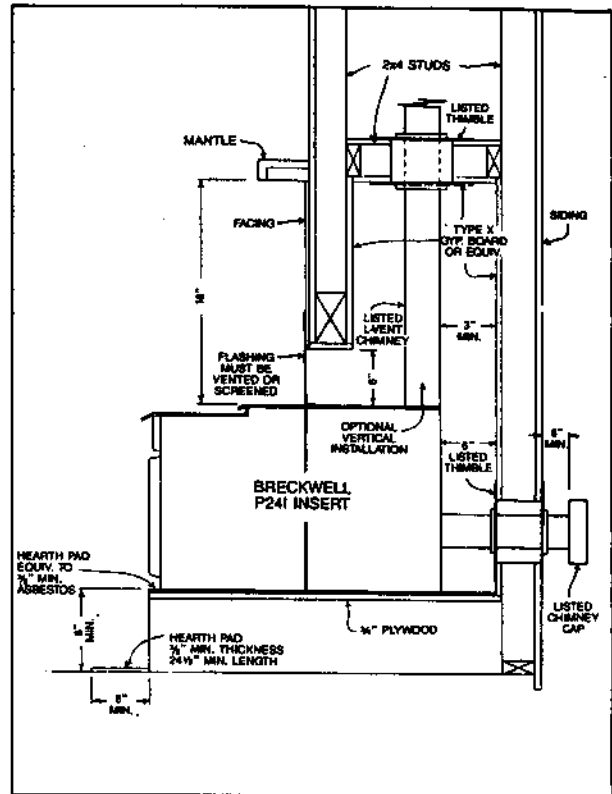

FACADE FRONT

FIGURE 7

2. Attach cerablanket as on previous page.
3. Measure and build blanking plate. Cut out hole for vent pipe (and combustion air intake pipe, if used). Install and carefully seal blanking plate as in previous step 5. Failure to properly seal may result in smoke spillage.
4. Slide vent pipe (and intake pipe if used) up through blanking plate hole, leaving enough to grab and pull down.
5. Set insert on hearth, complete steps 3 and 4 above. Be sure to seal where pipe passes through blanking plate.

2.323 NEW CONSTRUCTION — SPECIAL CHASE

Figure 7 describes a P24I installation vented into either a special chase built outside an outer wall or a false inside wall. This is especially suited for new construction or remodeling.

2.4 Electrical Installation

This stove is provided with an 8-foot grounded electrical cord extending from the rear of the stove. This should be connected to a standard 110 volt, 60 hz electrical outlet. The approximate power requirements are 150 watts.

2.5 Special Mobile Home Requirements

Mobile Home installations made prior to the initial sale of the mobile home are governed by US Department of Housing and Urban Development (HUD) standards. They include the following: a. Do not install in a sleeping room b. Stove should be grounded, with #8 copper wire and terminated with NED approved grounding device. c. Stove should be attached to mobile home during shipment.

3.0 OPERATION

3.1 Proper Fuel

THIS STOVE IS APPROVED FOR BURNING PELLETIZED WOOD FUEL ONLY! Factory-approved pellets are those 1/4" or 5/16" in diameter and not over 1" long. Longer or thicker pellets sometimes bridge the auger flight which prevents proper pellet feed. The burning of wood in forms other than pellets is not permitted. It will violate the building codes for which the stove has been approved and will void all warranties. The design incorporates automatic feed of the pellet fuel into the fire at a carefully prescribed rate. Any additional fuel introduced by hand will not increase heat output, but may seriously impair the stove's performance by generating considerable smoke. Do not burn wet pellets. The stove's performance depends heavily on the quality of your pellet fuel. Avoid pellet brands which display these characteristics:

- a. Excess Fines - "fines" is a term describing crushed pellets or loose material that looks like dust or sand. Pellets can be screened before being placed in hopper to remove most fines.
- b. Ash content greater than 1%.
- c. Binders - Some pellets are produced with petroleum distillates or other materials to hold them together, or bind them. These pellets are harder and can jam auger.

Poor quality pellets will often create smoke and dirty glass. They will create a need for more frequent maintenance. You will have to empty the burn pot and ash pan DAILY plus vacuum the entire system more often. Poor quality pellets could damage the auger. National Steelcrafters of Oregon cannot accept responsibility for damage due to poor quality pellets.

3.2 Pre-Startup Check

Clean firebox of all residue ash by scraping ash into ash pan (see sections 4.1 and 4.2). Remove burn pot and dump ash into ash pan. Remove ash pan and dump ash into metal container with lid. Replace ash pan and burn pot. Clean door glass if necessary (a dry cloth is usually sufficient). Check fuel in hopper and refill if necessary. **NOTE:** Hopper capacity is approximately 50 lbs.

3.3 Building a Fire

NOTE: During the first few fires, your stove will emit an odor as the high temperature paint cures or becomes seasoned to the metal. Maintaining smaller fires will minimize this. Avoid placing items on stove top during this period as paint could be affected.

- a. Check to make sure power cord from stove is plugged in.
- b. Fill burn pot by hand to level just below top air holes. Add approved fire starter, light and close door.
- c. Push damper control rod (located on right side of stove) all the way in.
- d. Push on/off switch to "on" position. Set fuel control knob to "1".
- e. When fire is burning well in burn pot, push "auger" button and pull damper rod out about 1/2-inch. When forced air flow becomes warm and auger starts feeding pellets, usually in about 10 minutes, set pellet feed knob to desired setting. Readjust damper setting (see section 3.6) **NOTE:** Auger will not start feeding pellets until firebox temperature reaches preset level.

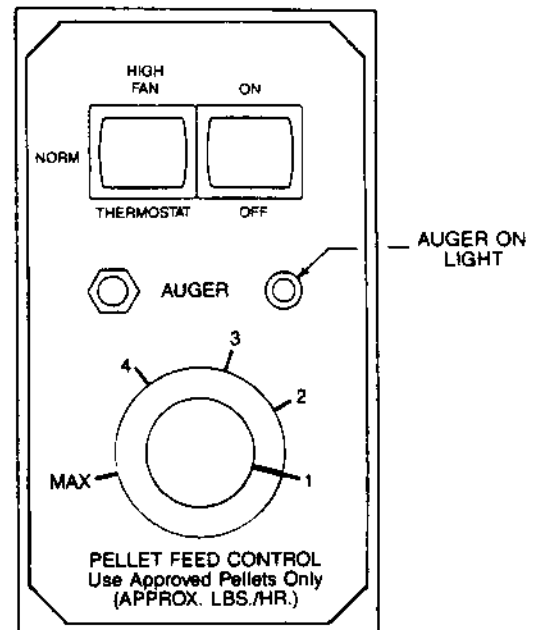

FIGURE 8

3.4 Panel Controls

The blowers and automatic fuel supply (auger) are controlled from a panel on the left side of the stove. The on-off switch turns the blowers on. The "norm/thermostat" switch should remain in the "norm" mode unless an optional remote wall therm-

ostat is installed (see section 3.5). The "auger" button activates the automatic feed system. When the green light is on, there is power to the auger. The auger will not begin feeding pellets until the firebox has warmed up to a preset temperature. In case of a power outage lasting more than one or two seconds, this button must be pushed to re-engage the auger.

The feed rate settings are shown in approximate lbs. per hour to help you plan your refueling schedule. Please note these rates are only approximate. The "Max" setting feeds approximately 4½ lbs./hour. The convection blower speed varies directly with feed rate. The "High Fan" switch overrides this variable speed function. It will set the convection blower speed to high at any feed rate setting.

3.5 Optional Thermostat

A remote thermostat will help you maintain a constant house temperature automatically. A low voltage, normally closed thermostat is recommended. When engaged, the stove will automatically switch between two settings. When warm enough, it will switch to "1", which also slows the convection blower. If the house then cools below your thermostat setting it will switch to a feed rate 60% of your knob setting. For example, if stove is set at 4 lbs./hour when you engage the "thermostat" switch (remember — do not engage unless you have a thermostat attached), the stove will burn at 60% of 4 lbs./hour, or 2.4 lbs./hour when the thermostat calls for more heat. Thermostat should be installed by an Authorized Breckwell dealer.

NOTE: When using the thermostat, it is important to set your damper control rod at approximately ½" out.

3.6 Damper Control

The damper control rod on the stove's right side adjusts the combustion air. This control is necessary due to the varied burn characteristics of individual installations, different pellet brands and pellet feed rates. It allows you to improve the efficiency of your stove. Also, it will reduce the frequency of cleaning your glass door and prevent the rapid buildup of creosote inside your stove and chimney.

You should adjust the rod based on the fire's appearance. A low, reddish, dirty fire can be improved by pulling the damper out slightly. A "blow torch" fire can be improved by pushing the damper in a bit.

As a general rule, on a low feed rate setting, the damper will be in. On higher feed rates, the damper should be more open. Through trial and error, you will find the best settings. Consult your dealer if you need help. NOTE: On "1" damper should be out a minimum of 1/8".

3.7 Refueling

You can calculate your refueling needs based roughly on the pellet feed rate setting. For example, at the "2" setting, a full hopper will last approximately 25 hours (50 lbs./2 lbs/hour). We recommend, however, that you not let the hopper drop below ¼ full.

3.8 Breckwell Maintenance Tools



Tools have been provided to help with the following functions:

- Open Hopper Lid - When stove is set at higher burn rates, the hopper lid can become very hot. Use tool to lift lid. Do not touch hot lid or burns could occur. (Tool A)
- Stir Pellets In Hopper - Unlike liquids in a tank, pellets do not drain evenly into the auger. Bridging across the opening can occur. Pellets can become hung up on one slope

of the hopper. Occasionally "stirring" the hopper can help. (Tool A)

- Ash Pan Removal - see instructions in section 4.1. (Tool A)
- Cleaning Heat Exchanger Tubes - see instructions, section 4.2. (Tool B)
- Scrape ashes from burn pot. (Tool A)

3.9 Shut Down Procedure

Turning the Breckwell off is a matter of pressing the control panel switch to off. The blowers will continue to operate until internal firebox temperatures have fallen to a preset level.

3.9.1 Safety Features

- If there is a power outage longer than one or two seconds, the auger will not operate once power is restored. This prevents pellets being fed to a non-burning burn pot. Pressing the auger button on the control panel will reactivate auger. The blowers will come on when power is restored to evacuate the combustion chamber of gases.
- In case of a malfunctioning convection air blower, a high temperature thermodisk will shut down the auger, preventing the stove from overheating. After stove cools down, pressing auger button will restart auger. NOTE: If high temperature thermostat activates, there is an electrical component failure and it should be checked out immediately.

3.9.2 Operating Safety Precautions

- DO NOT STORE OR USE FLAMMABLE LIQUIDS, especially gasoline, in the vicinity of your Breckwell Pellet Stove. Never use gasoline, gasoline-type lantern fuel, kerosene, charcoal lighter fluid or similar fluids to start or "freshen up" a fire in this heater.
- WARNING: DO NOT OVERFIRE THIS STOVE. This may cause serious damage to your stove and void your warranty. It also may create a fire hazard in your home. IF ANY EXTERNAL PART OF THE UNIT BEGINS TO GLOW, YOU ARE OVERFIRING. Immediately press "off" switch on control panel.
- Keep all household combustibles, such as furniture, drapes, toys, etc. three feet, or a considerable distance from the burning stove.
- Maintain proper ventilation. It is important that adequate oxygen be supplied to the fire for the combustion process. Modern houses are often so well insulated, it may become necessary to open a window or install an outside air vent to provide sufficient combustion air.
- Since heating with a solid fuel fire is potentially hazardous, even with a well made and thoroughly tested stove, it would be wise to install strategically placed smoke detectors and have a fire extinguisher in a convenient location.
- Do not open stove door when operating, unless necessary. This will create a dirty, inefficient burn and could allow sparks to escape.
- Do not permit operation by young children or those unfamiliar with stove's operation.
- Do not add more fuel than the automatic fuel system provides, as this could cause an overfiring condition.
- Do not service this appliance without disconnecting power cord.
- If during start up or operation you notice a smoldering fire (burn pot full but no visible flame) AND a heavy smoke build up in firebox, pull plug on unit. Do not tamper with any controls on stove. Wait 15 minutes or until firebox clears, open door, plug unit back in and restart fire. (See section 3.3)

4.0 MAINTENANCE

4.1 Ash Disposal - (see figure 12)

Remove ashes periodically as they fill the pan. To remove pan:

- Make sure fire is out.
- Remove burnpot by grasping and twist pulling straight out.
NOTE: Inspect burnpot periodically to see that holes have not become plugged.
- Empty ashes from burnpot into pan. Scrape burnpot with tool A.
- Use tool A to lift pan and pull out carefully.
- To replace, reverse procedure. Make sure burnpot is level when it is reinstalled.

Ashes should be placed in a metal container with a tight fitting lid. The closed container of ashes should be placed on a non-combustible surface on the ground, well away from all combustible materials pending final disposal. If ashes are disposed of by soil burial or otherwise locally dispersed, they should be retained in the closed container until all cinders have thoroughly cooled.

4.2 Firebox Cleaning

- The stove is designed with a built in heat exchange tube cleaner. This should be used every two or three days to remove accumulated ash on the tubes, which reduces heat transfer. Insert tool in cleaner key (see figure 9). Twist, move backwards and forwards several times. Leave key at front of stove.

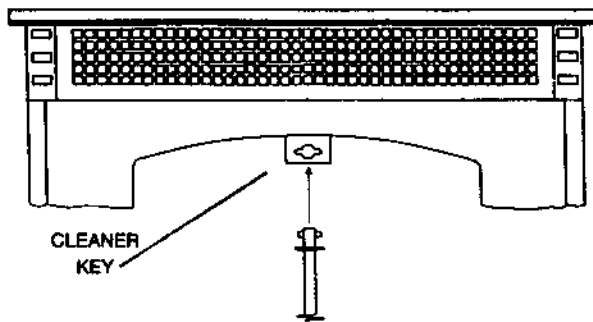

FIGURE 9

- Four (4) cover plates in the firebox can be removed for periodic cleaning (see figure 10). All four doors allow access to the chamber surrounding the firebox. Periodically, you must vacuum ashes from this chamber. In some cases you will need to remove creosote which can accumulate rapidly under certain conditions. A small wire brush can be used. It is important to remove this creosote since it is highly combustible. **INSPECT BEHIND THESE COVER PLATES AT LEAST ONCE PER TON OF PELLETS BURNED UNTIL YOU ARE FAMILIAR WITH HOW ASHES AND CREOSOTE ACCUMULATE WITH YOUR OPERATING PATTERNS.**
- Gasket around door and door glass should be inspected and repaired or replaced when necessary (see section 6.0).

4.3 Blowers

- Cleaning** — Over a period of time, ashes or dust may collect on the blades of both the combustion blower and convection blower. Periodically the blowers should be vacuumed

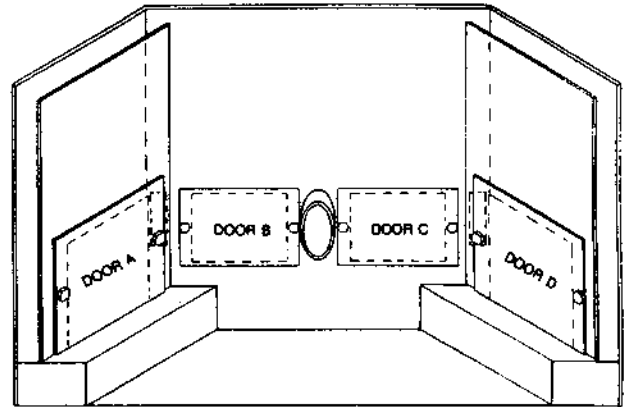

FIGURE 10

clean as these ashes can impede performance. Creosote can also accumulate in the combustion blower. This needs to be brushed clean. The convection blower is accessed by removing the stove's left side panel and the combustion blower is accessed through door C (see figure 10). **NOTE:** Be careful when cleaning not to dislodge balancing clip on convection blower, or bend fan blades. Some stove owners lightly spray an anti-creosote chemical on the fire to help reduce creosote formation within the stove.

- Oiling** — Blower manufacturers suggest oiling annually. See figure 11 for lubrication points. Use SAE 20W oil.

4.4 Chimney Cleaning

- Creosote Formation** — When wood is burned slowly, it produces tar and other organic vapors which combine with expelled moisture to form creosote. The creosote vapors condense in the relatively cool chimney flue of a newly started fire or from a slowly burning fire.

As a result, creosote residue accumulates on the flue lining. When ignited, this creosote makes an extremely hot fire which may damage the chimney or even destroy the house.

Despite their high efficiency, pellet stoves often accumulate creosote under normal conditions.

- Fly Ash** — This accumulates in the horizontal portion of an exhaust run. Though non-combustible, it may impede the normal exhaust function. It should therefore be periodically removed.
- Inspection and Removal** — The chimney connector and chimney should be inspected at least monthly during the heating season to determine if a creosote or fly ash buildup has occurred.

If creosote has accumulated, it should be removed to reduce the risk of a chimney fire. Inspect the system at the stove connection and at the chimney top. Cooler surfaces tend to build creosote deposits quicker, so it is important to check the chimney from the top as well as from the bottom.

The creosote should be removed with a brush specifically designed for the type of chimney in use. A chimney sweep can perform this service. It is also recommended that before each heating season the entire system be professionally inspected, cleaned, and repaired if necessary.

5.0 TROUBLE-SHOOTING GUIDE

When your stove acts out of the ordinary, the first reaction is to call for help. This guide may save time and money by enabling you to solve simple problems yourself. Problems can be due to only four factors: 1) poor fuel; 2) poor operation or maintenance; 3) poor installation; 4) factory defect. You can usually solve those related to 1 and 2. Your dealer can solve those in 3 and 4. Refer to figures 11, 12, and 13 to help locate indicated parts. REMINDER: Pull plug before servicing, unless otherwise instructed.

5.1 Fuel Will Not Feed

1. Check for fuel in hopper. See section 3.8b. If stove runs out of fuel, pellets will not feed once hopper is reloaded until auger fills with pellets. This takes several full turns of the auger.
2. Push "auger" button.
3. Check for auger jam. You can hear auger motor work at least every 15 seconds. If motor is working and auger is not, contact your dealer.
4. If auger motor is not working, and there is power to the system (green light is on) high temp or auger thermodisk may be stuck in wrong position. Check for continuity and tap lightly. If problem persists, call dealer.

5.2 Fire Goes Out

(assuming auger is feeding and there is ample fuel in hopper and burnpot)

1. Check for blockage in combustion air inlet, burnpot and exhaust.
2. Restart fire, adjust feed rate upwards. Large pellets, near or above the recommended size, feed more slowly. A fire sometimes CAN NOT be maintained on "1" or thermostat setting. When the fire goes out, a thermodisk shuts off the auger when the unit cools. If this problem recurs, either change to ¼" pellet fuel or use only manual setting and do not set feed rate below 1½ lbs./hr.
3. Check to see if combustion blower is operating.

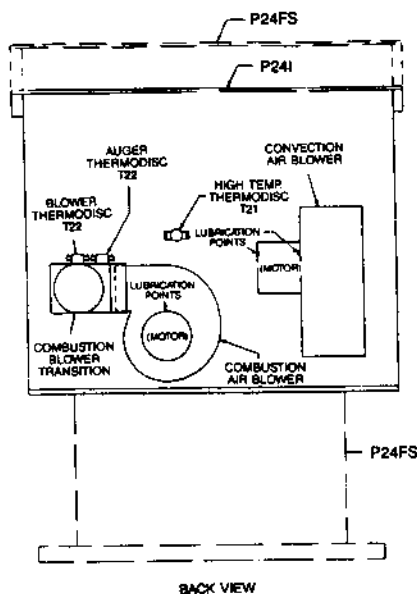

FIGURE 11

5.3 Smokey Fire (see section 3.6 first) (reddish flame, soot deposits on door glass)

1. Check door and door glass gasket. Door should be tightly sealed. Replace gasket if necessary.
2. Check that bumpot is installed properly and holes are not plugged.
3. Check for blockage in combustion air inlet and exhaust.
4. Check quality of fuel (see section 3.1).
5. Adjust slide damper (see section 3.6)

5.4 Pellet Feed Rate Varies From Setting

1. Check "manual/thermostat" setting. On "thermostat" stove will operate at 60% of selected burn rate.
2. Feed rate settings are approximate. You can expect minor variations.
3. Different size pellets feed at different rates amplifying variation.
4. Potentiometer problem. Contact dealer.

5.5 No Power

1. Check power supply to stove.

5.6 Blower Will Not Operate Properly

1. Check power supply.
2. Check blower thermodisk with continuity tester.
3. Clean and oil blowers.
4. When "on" switch is pushed at start-up, convection fan turns on low. Pushing "auger" button sets this blower at proper speed.

5.7 Noisy Operation

1. Identify source of noise (i.e. which motor).
2. Check tension of blower mounting screws if vibrating noise.
3. Check for dirty or unbalanced impeller wheel on blowers if clanging noise.
4. Oil blowers with SAE 20W oil.
5. Readjust convection blower speed (pellet feed control knob), if harmonic vibration.

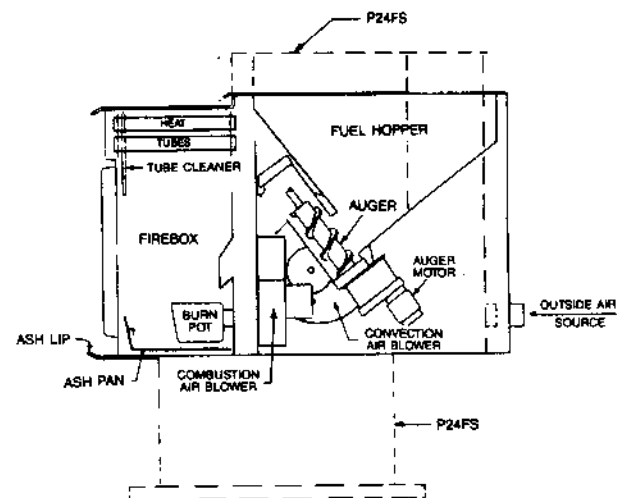

FIGURE 12

6.0 REPLACEMENT PARTS

If Breckwell parts need replacement, we suggest you contact your dealer.

Item

Spring Handle
 Door Glass
 Window Clips
 Door Gasket (five feet)
 Window Gasket (five feet)
 Circuit Board & Speed Control
 Convection Blower
 Combustion Blower
 Auger Gear Motor
 High Temp Thermodisk (T21)
 Auger/Blower Thermodisk (T22)
 Burn Pot
 Breckwell Maintenance Tools (A or B)
 Furnace Cement (2-oz.)

Optional Items for Your Breckwell

Vertical Installation Kit (P24FS)
 Brass Flashing Trim (P24I)
 Decorative Etched Door Glass
 Designer Colors
 22-Carat Gold Plated Cowl
 Adjustable Hearth Extension (P24I)
 Decor Top (P24I)

WIRING DIAGRAM

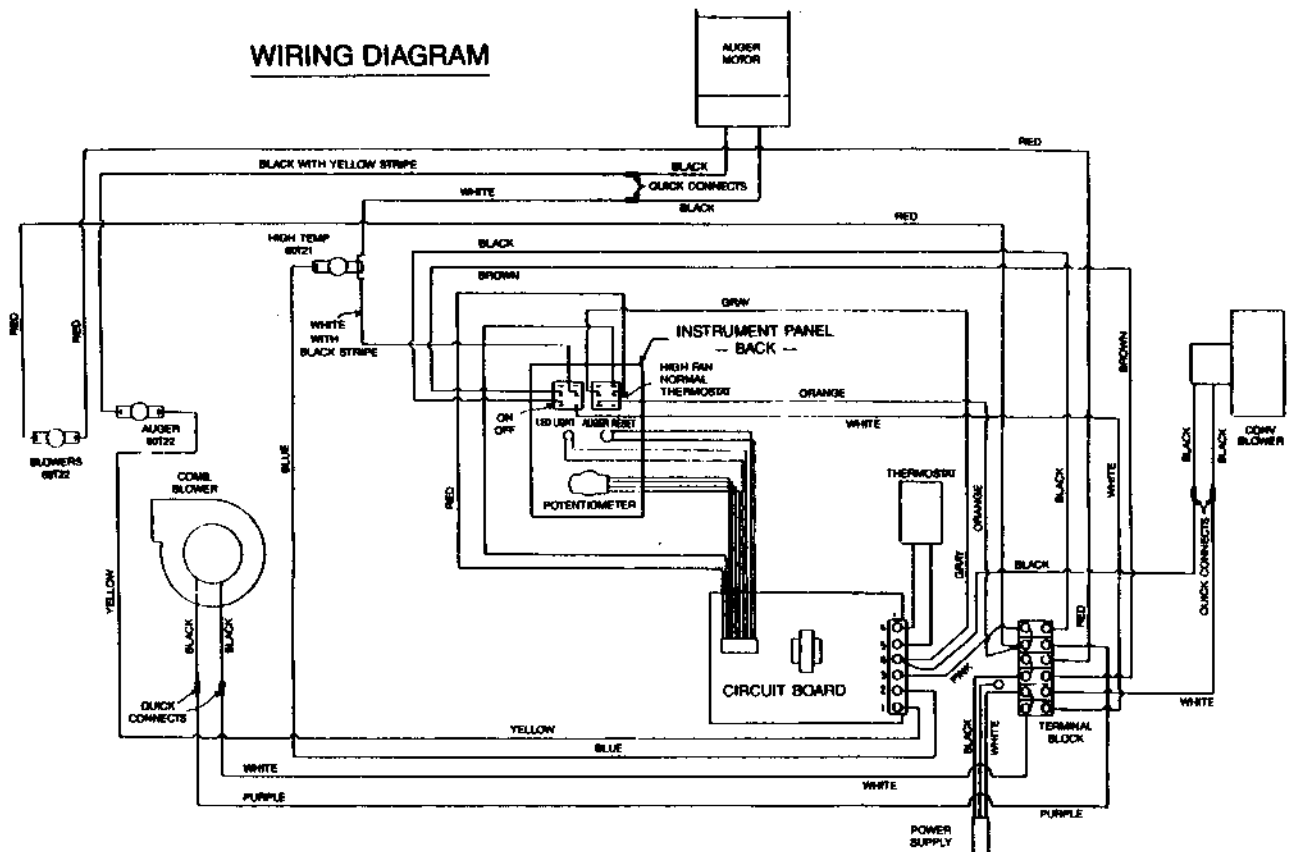

Free Manuals Download Website

<http://myh66.com>

<http://usermanuals.us>

<http://www.somanuals.com>

<http://www.4manuals.cc>

<http://www.manual-lib.com>

<http://www.404manual.com>

<http://www.luxmanual.com>

<http://aubethermostatmanual.com>

Golf course search by state

<http://golfingnear.com>

Email search by domain

<http://emailbydomain.com>

Auto manuals search

<http://auto.somanuals.com>

TV manuals search

<http://tv.somanuals.com>