



## Aqua Fountain



 **BRITA**<sup>®</sup>  
Water Technology

## Instructions for Use

PLEASE RETAIN THESE INSTRUCTIONS FOR FUTURE REFERENCE.

These instructions refer to the Breville Water Filter/Chillers AF5 and AF6  
Download from [www.Somanuals.com](http://www.Somanuals.com). All Manuals Search And Download.

# INTRODUCTION

Congratulations on the purchase of your Breville BRITA Aqua Fountain chiller.

In the unlikely event of experiencing any difficulties, call:

**BRITA Customer Careline: 0844 7424800 for expert advice**

(Monday - Friday 8.30am - 5.30pm. Local rates apply)

Also remember to REGISTER your chiller online or by the enclosed card

**[www.brita.co.uk](http://www.brita.co.uk)**

## QUICKSET-UP GUIDE

Detailed instructions are included but for a quick set up, follow these key tips:

- 1 Before use, make sure water tanks are thoroughly washed and that water is flushed through the entire chiller system (the removable bottom plug will aid this). *See page 4 for full instructions.*
- 2 For optimum taste and filtration speed, ensure your BRITA Maxtra cartridge is properly prepared before insertion into the top water tank. *See page 5 for full instructions.*
- 3 When positioning the Aqua Fountain ensure it has a minimum of 15cm clearance for the ventilation slots at the back for efficient air circulation and maximum water cooling performance. *See page 4 for full instructions.*
- 4 Use a jug to fill the tanks with cold water and take care not to spill down the tank sides or fill beyond the MAX FILL LEVEL. *Add the water until all tanks are full.*

To prevent air locks in the internal chilled water tank, depress the dispense lever until the water flows out. *See page 6 for full instructions.*

- 5 Keep your Aqua Fountain out of direct sunlight and away from any heat sources. *See page 6 for full instructions.*
- 6 Cooling time will vary depending on your ambient and water temperature. *See page 6 for full instructions.*

# FEATURES

Fig 1



1. BRITA Memo - cartridge exchange indicator
2. Upper water tank cover
3. Hinged lid
4. 1 litre upper water tank
5. 2 litre filtered water tank
6. ON/OFF switch
7. Red power on indicator
8. Chilled water indicator
9. Water dispenser lever
10. 1 litre chilled filtered water tank
11. BRITA MAXTRA water filter

## BEFORE USING YOUR WATER FILTER/CHILLER

Before using your water filter/chiller for the first time, it is recommended that the unit is flushed through with fresh water. Please ensure that you read the following instructions before flushing your water filter/chiller several times.

1. Remove your water filter/chiller carefully from the box. You may wish to store the packaging for future use.
2. Check the contents:
  - Water filter/chiller
  - BRITA MAXTRA water filter cartridge
  - User guide
  - BRITA brochure
  - BRITA registration card
3. Wash the clear plastic lid, upper and filtered water tanks in warm soapy water, rinse and dry thoroughly.
4. Reassemble the tanks as shown below.

5. Position the water filter/chiller on a stable flat surface, close to a mains power socket, not in direct sunlight and out of the reach of children.
6. **Make sure that there is sufficient space around the water filter/chiller to allow the heat extracted during the chilling process to dissipate. Leave a gap of at least 15 cm between the ventilation slots on the rear of the chiller and any wall or surface.**  
**Do not plug the unit in or install the filter cartridge yet.**
7. Lift the hinged lid and using a suitable jug, pour 2 litres of clean water into the tank. Place a glass under the dispenser and push the dispensing lever back to drain all of the water. It may take some time for the water to initially flow through.
8. Repeat this process one more time.



Upper water tank cover



Upper water tank

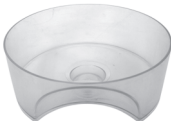

Filtered water tank



Chilled and filtered water tank

## PREPARING THE FILTER CARTRIDGE

1. Remove the cartridge from its wrapping (it is normal for the cartridge to appear moist during storage - this is simply condensation).
2. Immerse the cartridge in cold water and agitate gently to remove any air bubbles.

### NOTE

There is no need to pre-soak this cartridge before use.

3. Remove the lid from the upper water tank.
4. Insert the filter cartridge into the water tank as shown below. Push it firmly into place. When correctly fitted, the cartridge should remain in place when the tank is turned upside down.



1. Place the upper tank on a suitable bowl or jug. Fill with cold tap water up to the MAX FILL LEVEL mark on the upper water tank and allow the water to filter through.

Maximum fill level mark

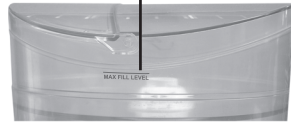

Discard the first two fillings. These first two fillings are used to flush the filter cartridge. Place the upper tank back into the unit.

2. Replace the upper water tank lid.
3. Press and hold the START button on the BRITA Memo on the lid until all of the bars on the display appear and flash twice, see "Using the Memo function" on page 8.

### NOTE

When it is time to replace the cartridge after 4 weeks use, simply lift the ring pull handle on top of the cartridge to remove. The cartridge may be disposed of in household waste or contact the BRITA-Care customer service for advice on recycling schemes.

## USING YOUR WATER FILTER/CHILLER

1. Lift the hinged lid and using a suitable jug, carefully pour water into the tank up to the MAX FILL LEVEL. This may take some time due to the action of the filter.



2. Keep adding water until all the tanks are full. Water flows through the cartridge at a set rate. This is to achieve the best possible filtration. Because of this it may take some time to fill all the tanks on first use. During normal use top up the tanks regularly.

### NOTE

After filling, it is important to vent any air in the unit otherwise the chiller will not function correctly. Do this by pressing the dispensing lever until the water flows from the dispenser without any air bubbles present. Once the water is clear of any air bubbles, the dispensing lever may be released. Top up the water tank if necessary.

3. Close the hinged lid.

4. Plug the unit into the mains supply. Press the chiller ON/OFF switch on the front of the unit. The switch will illuminate and the machine will begin to chill the water.
5. Dispense 2 litres of water from the unit to remove any unfiltered water from the unit that was used to prepare the chiller as instructed on page 4.
6. Within approximately 3 hours the blue indicator on the front of the unit will light indicating that the water has chilled to approximately 10°C, although this may take longer in very hot weather. The indicator will cycle on and off as the unit maintains its temperature, but the unit will continue to chill the water down to 8°C then stop. If the water temperature rises above 8°C the unit will start to chill again.

**We recommend that the water chiller be kept out of direct sunlight and away from any heat source.**

7. Place a glass under the dispenser and push the lever back to dispense water.

### NOTE

It is normal for the indicator to go off when water is drawn. Water inside the unit will remain chilled but the indicator will not come on again until the optimum temperature has been reached.

8. Top up the water tank as necessary.

# USING YOUR WATER FILTER/CHILLER

For optimum enjoyment, we recommend that if your water chiller has not been used for 1 day or more, you first draw half a glass of water and dispose of it. It is possible to use the unit without power but the water will not be chilled. Remember that water is a foodstuff. Please consume filtered water within 2 days.

To empty filtered water from the system, use the plug in the base of the chiller as instructed in the storage section on page 10.

When replacing the bottom 2 litre filtered water tank, please ensure that there is no water in the inner well (illustrated below).

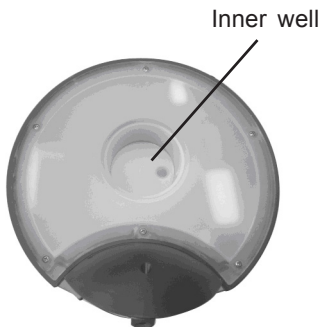

If there is water present, dispense the water using the lever until the well is empty.

Should water spill from the tank it is not dangerous. Do not grasp or pull on the tank sections to move or reposition the unit.

## NOTE

There is a risk of leakage from the split joint between the top tank and filtered water tank. This may occur if the unit is moved or disturbed when both tanks are at maximum capacity. To avoid leakage, draw off water using the lever to empty the top tank so that it does not overflow when moved.

## Troubleshooting

Water is not dispensed:

- Make sure that there is water in the tank.
- Air trapped in the filter cartridge may stop water flowing into the filtered water tank. The cartridge must be immersed in cold water and agitated to removed any air bubbles before installation.
- Filter is blocked. Replace.
- Air can become trapped in the internal tank. Press the dispensing lever until clear water dispenses without any air bubbles. This may take some time.

Chiller light tuning off and on:

- The chiller light will not stay on permanently. It will cycle on and off as the temperature of the water is maintained.

## USING THE BRITAMEMO FUNCTION

It is important to change your BRITA water filter cartridge regularly to enjoy the benefits of BRITA filtered water. The BRITA Memo system automatically reminds you when your water filter cartridge needs to be changed.

When you have fitted and prepared your water filter cartridge, start the Memo system as follows:

- Press and hold the start button until four bars appear in the display and flash twice. The Memo is now set. The flashing dot in the bottom right corner of the display will show that the Memo is working.
- Every week one bar will disappear to indicate the remaining cartridge life.

*When only one bar is showing, check that you have a replacement BRITA MAXTRA water filter cartridge available.*

- After four weeks, all four bars will disappear and a flashing arrow will appear to indicate that the filter cartridge should be replaced.

Insert a new BRITA water filter cartridge (as described under "Changing the BRITA MAXTRA Filter Cartridge" on page 9) and restart the Memo as described above.

Please note: The Memo system is only intended for use with BRITA filter cartridges.

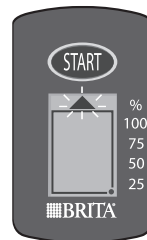
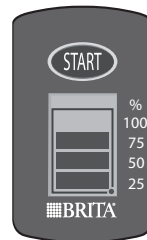
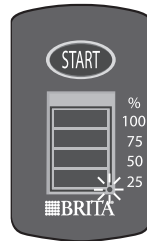
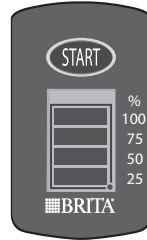



## CHANGING THE BRITA MAXTRA FILTER CARTRIDGE

The filter cartridge will need to be changed approximately once per month.

1. Switch the water filter/chiller off and disconnect from the mains supply.
2. Using the dispenser, (as described in Cleaning and Maintenance on page 10) completely drain the water from the tanks.
3. Remove the upper water tank cover.
4. Pull the BRITA MAXTRA filter cartridge out of the unit and discard it.
5. Wash the lid and tanks in warm soapy water, rinse and dry thoroughly.
6. Remove the new BRITA MAXTRA filter cartridge from its wrapping.
7. Follow the instructions in “Preparing the Filter Cartridge” on page 5.
8. Insert the BRITA MAXTRA filter cartridge into its receptacle in the upper water tank.
9. Replace the upper water tank lid.
10. Restart the BRITA Memo system as described in “Using the BRITA Memo Function” on page 8.
11. Lift the hinged lid and refill the tanks.
12. Close the hinged lid.
13. Plug the unit into the mains and press the chiller ON/OFF switch on the front of the unit and wait for the water to chill.

### NOTE

The cartridge and inside wrapper may be moist - this is simply condensation.

### NOTE

Always make sure you have spare cartridges to hand. When buying cartridges look for the BRITA MAXTRA symbol on the cartridge packaging to find the correct filter cartridge in store.



# CLEANING AND MAINTENANCE

## Cleaning

The outer casing of your water filter chiller can be cleaned using a soft damp cloth and a non-abrasive cleaner.

It is important that the inside of the chiller is cleaned regularly. We recommend that this is done **at least monthly** e.g. when changing the Maxtra cartridge. Also, ensure that the dispensing nozzle is cleaned regularly.

## Cleaning Instructions

1. Disconnect the chiller from the electrical socket and drain all the water by unscrewing the drain plug on the bottom of the unit over a sink or large container.
2. When empty of water replace the drain plug.
3. Remove the lid and top up the water tank, leaving the bottom water tank in place.
4. Pour approximately 2 litres of water into the bottom tank, and add a non-tainting sterilising fluid such as Milton (following manufacturer's guidelines for dilution).
5. Depress dispensing lever until fluid starts to come out of the dispensing nozzle.
6. Stop depressing the lever when the fluid comes through the nozzle.
7. Leave the fluid to stand in the chiller as recommended by the fluid manufacturers instructions (normally approximately 10/15 minutes).
8. Drain the chiller using the drain plug at the bottom of the unit over a sink or large container. Replace the drain plug.

9. To flush through the system pour approximately 2 litres of water into the tank, depress the dispensing lever until water starts to come out of the dispensing nozzle, and then empty using the drain plug at the bottom of the unit over a sink or large container. Replace the drain plug.

10. Your chiller is now ready to use. Fill the chiller tanks with tap water as per chiller instructions, plug the unit into the socket and turn on. Use the chiller as normal.

## Storage

If you are not going to use your water filter chiller for an extended time **disconnect the unit from the mains** and drain the water using the drain plug at the bottom of the unit over a sink or large container.

Remove the filter cartridge and discard. Leave the lid off and allow the unit to dry thoroughly.

If the chiller has not been used for an extended time, follow the internal cleaning instructions above before reusing.



Drain Plug

## IMPORTANT SAFETY INSTRUCTIONS

- ✓ **Always** ensure hands are dry before handling the plug or switching on the appliance.
- ✓ **Always** use the appliance on a secure, dry level surface.
- ✓ **Always** unwind the power cord before use.
- ✓ **Always** carry out regular checks of the supply cord to ensure no damage is evident. Should there be any signs that the cord is damaged in the slightest degree, the entire appliance should be returned to the Customer Service Department.
- ✓ **Always** allow 15 cm of air space above and on all sides for air circulation. Do not allow the appliance to touch curtains, wall coverings, clothing, dish towels or other flammable materials during use.
- ✓ **Always** use BRITA MAXTRA water filter cartridges.
- ✓ **Always** unplug the appliance from the mains power supply socket before filling with water, after use, and before cleaning.
- ✓ **Always** return the appliance after a malfunction, or if it has been damaged in any manner to the Customer Service Department for examination, repair or adjustment as **special purpose tools are required**.
- ✓ **Always** ensure that the filter is securely positioned.
- ✓ **Always** reset the BRITA Memo after changing the filter.
  
- ✓ **Always** Remember that water is a foodstuff. Please consume filtered water within 2 days. To empty filtered water form the unit please use plug in the base of chiller as instructed in the storage section on page 10.
- ✓ **Always** Clean the inside and dispenser of the chiller at least every 2-3 weeks.
  
- ✗ **Never** use this appliance outdoors.
- ✗ **Never** use this appliance for other than the intended use. This appliance is for household use only.
- ✗ **Never** immerse any part of the appliance, cordset or plug in water or any other liquid to protect against electrical hazards.
- ✗ **Never** use harsh, abrasive or caustic cleaners to clean this appliance.
- ✗ **Never** let the cable hang over the edge of the worktop, touch hot surfaces or become knotted.
- ✗ **Never** place this appliance on or near a hot gas or electric burner or where it could touch a heated oven or microwave oven.
- ✗ **Never** operate any appliance with a damaged cable or plug or after an appliance malfunction or if it has been damaged in any manner.
- ✗ **Never** keep the appliance in an environment below 0°C. Water in the unit will freeze and cause damage.
- ✗ **Never** use any attachment or accessory not supplied with the appliance or not recommended by the appliance manufacturer.
- ✗ **Never** fill the water tank with any liquid other than water.
- ✗ **Never** use the water filter/chiller without a water filter cartridge fitted. The Breville water filter/chiller is designed to be used with the BRITA MAXTRA filter cartridge.
- ✗ **Never** attempt to filter untreated, raw water or water of unknown quality. This water filter cartridge must only be used with municipally treated tap water.

## CONNECTION TO THE MAINS SUPPLY

When using electrical appliances, basic safety precautions should always be followed.

### ⚠ WARNING

**THIS APPLIANCE MUST BE EARTHED**

If this appliance is fitted with a rewirable BS1363, 13 amp plug, the fuse should be rated at 3 amps and be ASTA approved to BS1362. However if the plug is unsuitable, it should be dismantled and removed from the supply cord and an appropriate plug fitted as detailed below.

If this appliance is fitted with a moulded BS1363 13 amp plug, the fuse should be rated at 3 amps and be ASTA approved to BS1362. If the fuse in a non-rewirable plug needs to be changed, the fuse cover must be refitted. The appliance must not be used without the fuse cover fitted.

In the event of the plug being unsuitable, it should be changed and an appropriate plug fitted as detailed below. If you remove the plug it must not be connected to a 13 amp socket and the plug must be disposed of immediately.

As the colours of the wires in the mains lead of this appliance may not correspond with the coloured markings identifying the terminals in your plug, proceed as follows:

The wires of the mains lead are coloured in accordance with the following code:

**GREEN & YELLOW = EARTH    BLUE = NEUTRAL    BROWN = LIVE**

The wire which is coloured **GREEN & YELLOW** must be connected to the terminal in your plug which is marked with an E or by the EARTH SYMBOL  $\oplus$  or coloured **GREEN** or **GREEN & YELLOW**.

The wire which is coloured **BLUE** must be connected to the terminal in your plug which is marked with the letter **N** or coloured **BLACK**.

The wire which is coloured **BROWN** must be connected to the terminal in your plug which is marked with the letter **L** or coloured **RED**.

If any other plug is used, a 3 amp fuse must be fitted either in the plug or adaptor or at the distributor board.

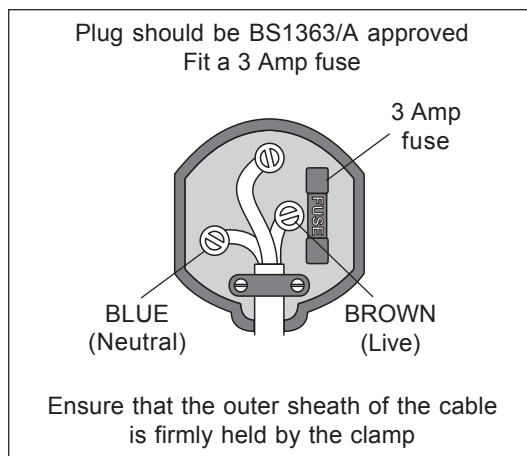

## AFTER SALES SERVICE

These appliances are built to the very highest of standards. There are no user-serviceable parts. Follow these steps if the unit fails to operate:

- 1 Check instructions have been followed correctly.
- 2 Check fuse has not blown.
- 3 Check mains supply is functional.

If the appliance will still not operate, return the appliance to the place it was purchased for a replacement. To return the appliance to the Customer Service Department, follow the steps below:

1. Pack it carefully (preferably in the original carton). Ensure unit is clean.
2. Enclose your name and address and quote model number AF7 on all correspondence.
3. Give the reason why you are returning it.
4. If within the guarantee period, state when and where it was purchased and include proof of purchase (eg. till receipt).
5. Send it to our Customer Service Department at the address below:

***Customer Service Department  
Pulse Home Products Limited  
Vine Mill, Middleton Road,  
Royton,  
Oldham  
OL2 5LN, UK.***

***Telephone: 0161 621 6900 Fax: 0161 626 0391  
e-mail: [info@pulse-uk.co.uk](mailto:info@pulse-uk.co.uk)***

6. For BRITA/MAXTRA water filter cartridge and BRITA Memo queries, contact BRITA Customer Care Services on:

***[www.brita.co.uk](http://www.brita.co.uk)  
Telephone: 0870 487 1000  
[enquiries@brita.co.uk](mailto:enquiries@brita.co.uk)***

## GUARANTEE

This product is guaranteed for a period of 1 year from the date of purchase against mechanical and electrical defects.

This guarantee is only valid if the appliance is used solely for domestic purposes in accordance with the instructions provided, that it is not connected to an unsuitable electricity supply, dismantled or interfered with in any way or damaged through misuse. Under this guarantee we undertake to repair or replace free of charge any parts found to be defective.

Nothing in this guarantee or the instructions relating to the product excludes, restricts or otherwise affects your statutory rights.

In line with our policy of continuous development, we reserve the right to change this product, packaging and documentation without notice.

This product is manufactured to comply with the radio interference requirements of **EEC** directive 93/68 EEC.



## RECYCLING INFORMATION

The Maxtra cartridge in the chiller is 100% recyclable. Look out for BRITA recycling points in major retailers or visit [www.brita.co.uk](http://www.brita.co.uk) for more information.

### Waste Electrical and Electronic Equipment (WEEE)

WEEE is the fastest growing waste stream in the UK, growing by at least 5% each year. The UK public alone dispose of over 1.2 million tonnes of electrical and electronic waste every year; this would fill the new Wembley Stadium 6 times over.

Much of the UK's electronic waste ends up in landfill sites. It has been estimated that landfill space in the UK will run out within the next 10 years if we do not increase the amount of waste we recycle.

WEEE that is not recycled can have negative impacts on soil, air and water quality which can lead to environmental damage and which can also lead to negative impacts on human and animal health.

### Recycling household electrical equipment – regulations

With effect from July 2007, the UK's Waste electrical and Electronic Equipment (WEEE) Regulation require that all producers of electrical equipment are now obliged to pay for recycling of household electrical goods, where previously this bill was met by councils or items were not recycled at all. These regulations also require that all retailers both actively assist in delivering a UK wide WEEE collection infrastructure and encourage the participation of consumers in recycling electronic equipment.

So that you can get your waste electrical goods recycled, we have contributed towards a national fund to assist local councils to further develop their existing waste electronics collection facilities, which will in turn allow producers of this equipment to meet their obligations.

# RECYCLING INFORMATION

## The Crossed out Wheeled Bin Symbol

All new electrical and electronic equipment should be marked with the crossed out wheeled bin, which aims to encourage you to separate out WEEE from other household waste and to dispose of it at a recycling facility.

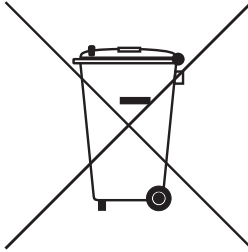

## [recycle-more.co.uk](http://recycle-more.co.uk)

For advice on all aspects of recycling, to find out how to minimise your effect on the environment and locate your nearest recycling facilities for electronic waste please visit [www.recycle-more.co.uk](http://www.recycle-more.co.uk) and use the recycle-more bank locator.

Recycle-more.co.uk also offers top tip and advice on all aspects of recycling, making it easier and quicker to protect our environment and recycle-more!













Vine Mill, Middleton Road, Royton, Oldham, OL2 5LN, UK.  
[www.breville.co.uk](http://www.breville.co.uk)

Breville is a registered trademark of Pulse Home Products Limited  
© Pulse Home Products Limited

92423-6  
AF5\_6\_iss\_8 02/08

## Free Manuals Download Website

<http://myh66.com>

<http://usermanuals.us>

<http://www.somanuals.com>

<http://www.4manuals.cc>

<http://www.manual-lib.com>

<http://www.404manual.com>

<http://www.luxmanual.com>

<http://aubethermostatmanual.com>

Golf course search by state

<http://golfingnear.com>

Email search by domain

<http://emailbydomain.com>

Auto manuals search

<http://auto.somanuals.com>

TV manuals search

<http://tv.somanuals.com>