

BRIGGS & STRATTON

**PORTABLE
GENERATOR**

Operator's Manual

03023 I

3600 Watts

5400 STARTING WATTS

Questions?

Help is just a moment away!

Find your Briggs and Stratton distributor
at www.briggsandstratton.com
or contact your local Briggs and Stratton dealer.



WARNING

Before using this product, read
this manual and follow all Safety
Rules and Operating Instructions.



**BRIGGS & STRATTON POWER PRODUCTS GROUP, LLC
JEFFERSON, WISCONSIN, U.S.A.**

Manual No. 199454GS
Revision 0 (02/09/2006)



SAVE THESE INSTRUCTIONS

TABLE OF CONTENTS

Safety Rules2-4
 Features and Controls5
 Assembly6
 Operation7-12
 Specifications13
 Maintenance13
 Storage14
 Troubleshooting15
 Warranty16

EQUIPMENT DESCRIPTION



Read this manual carefully and become familiar with your generator. Know its applications, its limitations and any hazards involved.

The generators are an engine-driven, revolving field, alternating current (AC) generator. It was designed to supply electrical power for operating compatible electrical lighting, appliances, tools and motor loads. The generator's revolving field is driven at about 3,600 rpm by a single-cylinder engine.

CAUTION! DO NOT exceed the generator's wattage/amperage capacity. See "Don't Overload Generator".

Every effort has been made to ensure that information in this manual is accurate and current. However, we reserve the right to change, alter or otherwise improve the product and this document at any time without prior notice.

The Emission Control System for this generator is warranted for standards set by the Environmental Protection Agency. For warranty information refer to the engine owner's manual.

SAFETY RULES



This is the safety alert symbol. It is used to alert you to potential personal injury hazards. Obey all safety messages that follow this symbol to avoid possible injury or death.







The safety alert symbol () is used with a signal word (DANGER, CAUTION, WARNING), a pictorial and/or a safety message to alert you to hazards. **DANGER** indicates a hazard which, if not avoided, *will* result in death or serious injury. **WARNING** indicates a hazard which, if not avoided, *could* result in death or serious injury. **CAUTION** indicates a hazard which, if not avoided, *might* result in minor or moderate injury. **CAUTION**, when used **without** the alert symbol, indicates a situation that could result in equipment damage. Follow safety messages to avoid or reduce the risk of injury or death.



WARNING

The engine exhaust from this product contains chemicals known to the State of California to cause cancer, birth defects, or other reproductive harm.

Hazard Symbols and Meanings

		
Operator's Manual	Electrical Shock	
		
Explosion	Fire	
		
Toxic Fumes	Kickback	Hot Surface

Copyright © 2006 Briggs & Stratton Power Products Group, LLC. All rights reserved. No part of this material may be reproduced or transmitted in any form by any means without the express written permission of Briggs & Stratton Power Products Group, LLC.



WARNING

 Running generator gives off carbon monoxide, an odorless, colorless, poison gas. Breathing carbon monoxide can cause nausea, fainting or death.

- Operate generator **ONLY** outdoors.
- Keep exhaust gas from entering a confined area through windows, doors, ventilation intakes or other openings.
- **DO NOT** operate generator inside any building or enclosure (even if doors or windows are open), including the generator compartment of a recreational vehicle (RV).

WARNING

 Generator produces powerful voltage. Failure to isolate generator from power utility can result in death or injury to electric utility workers due to backfeed of electrical energy.

- When using generator for backup power, notify utility company. Use approved transfer equipment to isolate generator from electric utility.
- Use a ground fault circuit interrupter (GFCI) in any damp or highly conductive area, such as metal decking or steel work.
- **DO NOT** touch bare wires or receptacles.
- **DO NOT** use generator with electrical cords which are worn, frayed, bare or otherwise damaged.
- **DO NOT** operate generator in the rain or wet weather.
- **DO NOT** handle generator or electrical cords while standing in water, while barefoot, or while hands or feet are wet.
- **DO NOT** allow unqualified persons or children to operate or service generator.

WARNING

- This generator must not be used on marine applications.
- Using this generator in marine applications could result in bodily injury and/or property damage.

WARNING

 Petrol and its vapors are extremely flammable and explosive.

 Fire or explosion can cause severe burns or death.

WHEN ADDING OR DRAINING PETROL

- Turn generator **OFF** and let it cool at least 2 minutes before removing petrol cap. Loosen cap slowly to relieve pressure in tank.
- Fill or drain petrol tank outdoors.
- **DO NOT** overfill tank. Allow space for petrol expansion.
- Keep petrol away from sparks, open flames, pilot lights, heat, and other ignition sources.
- **DO NOT** light a cigarette or smoke.

WHEN STARTING EQUIPMENT

- Ensure spark plug, muffler, petrol cap and air cleaner are in place.
- **DO NOT** crank engine with spark plug removed.
- Wait for any spilled petrol to evaporate before starting engine.

WHEN OPERATING EQUIPMENT

- Do not tip engine or equipment at angle which causes petrol to spill.
- This generator is not for use in mobile equipment or marine applications.

WHEN TRANSPORTING OR REPAIRING EQUIPMENT

- Transport/repair with petrol tank **EMPTY** or with petrol shutoff valve **OFF**.
- Disconnect spark plug wire.

WHEN STORING PETROL OR EQUIPMENT WITH PETROL IN TANK

- Store away from furnaces, stoves, water heaters, clothes dryers or other appliances that have pilot light or other ignition source because they can ignite petrol vapors.





WARNING

 Rapid retraction of starter cord (kickback) will pull hand and arm toward engine faster than you can let go.
Broken bones, fractures, bruises or sprains could result.

- When starting engine, pull cord slowly until resistance is felt and then pull rapidly to avoid kickback.
- NEVER start or stop engine with electrical devices plugged in and turned on.

WARNING

 Unintentional sparking can result in fire or electric shock.



WHEN ADJUSTING OR MAKING REPAIRS TO YOUR GENERATOR

- Disconnect the spark plug wire from the spark plug and place the wire where it cannot contact spark plug.

WHEN TESTING FOR ENGINE SPARK

- Use approved spark plug tester.
- DO NOT check for spark with spark plug removed.

WARNING

 Running engines produce heat. Temperature of muffler and nearby areas can reach or exceed 65°C (150°F).
 Severe burns can occur on contact.
Exhaust heat/gases can ignite combustibles, structures or damage petrol tank causing a fire.

- DO NOT touch hot surfaces and avoid hot exhaust gases.
- Allow equipment to cool before touching.
- Keep at least 1.5 m (5 ft.) clearance on all sides of generator including overhead.

CAUTION

 Excessively high operating speeds increase risk of injury and damage to generator.
Excessively low speeds impose a heavy load.

- DO NOT tamper with governed speed. Generator supplies correct rated frequency and voltage when running at governed speed.
- DO NOT modify generator in any way.

CAUTION

Exceeding generators wattage/amperage capacity can damage generator and/or electrical devices connected to it.

- See “Don’t Overload Generator”.
- Start generator and let engine stabilize before connecting electrical loads.
- Connect electrical loads in OFF position, then turn ON for operation.
- Turn electrical loads OFF and disconnect from generator before stopping generator.

CAUTION

Improper treatment of generator can damage it and shorten its life.

- Use generator only for intended uses.
- Operate generator only on level surfaces.
- DO NOT expose generator to excessive moisture, dust, dirt, or corrosive vapors.
- DO NOT insert any objects through cooling slots.
- If connected devices overheat, turn them off and disconnect them from generator.
- Shut off generator if:
 - electrical output is lost;
 - equipment sparks, smokes, or emits flames;
 - unit vibrates excessively.



KNOW YOUR GENERATOR



Read this Operator's Manual and safety rules before operating your generator.

Compare the illustrations with your generator, to familiarize yourself with the locations of various controls and adjustments. Save this manual for future reference.

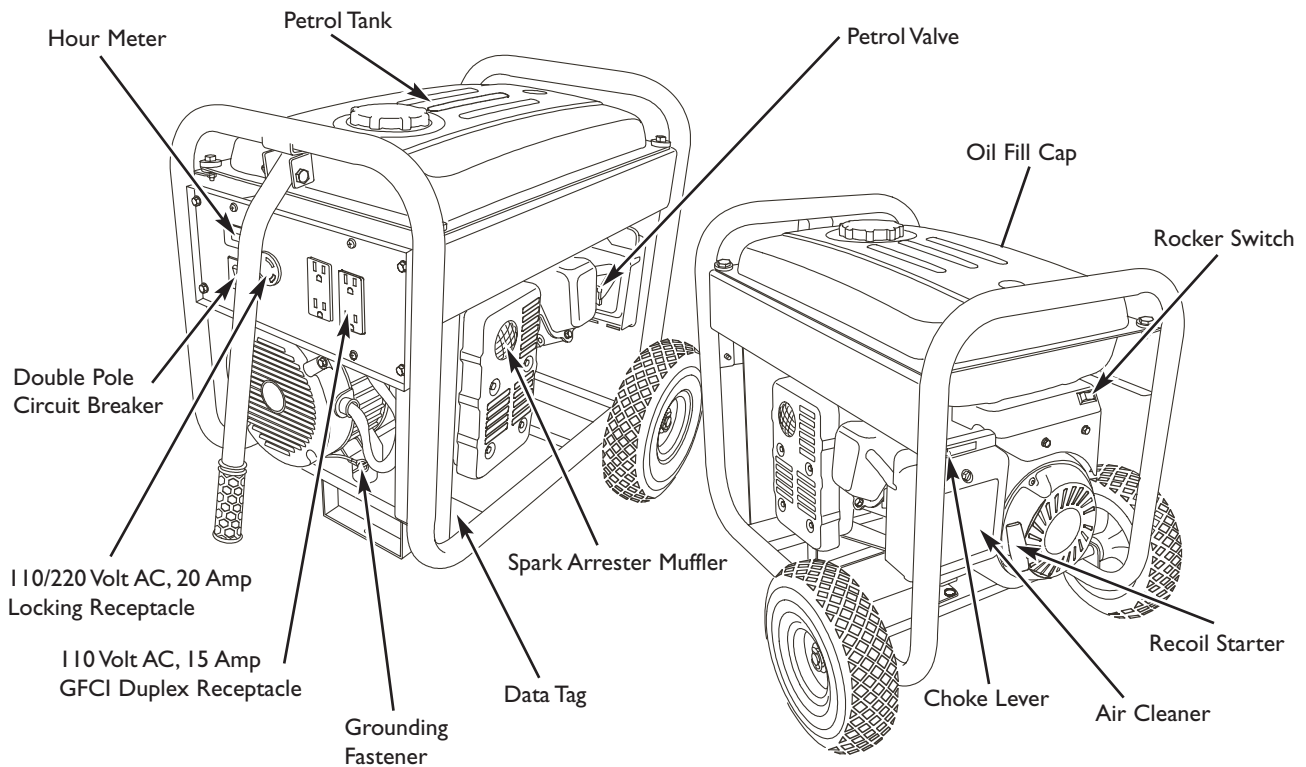

110 Volt AC, 15 Amp GFCI Duplex Receptacle — May be used to supply electrical power for the operation of 110 Volt AC, 15 Amp, single phase, 60 Hz electrical lighting, appliance, tool and motor loads.

110/220 Volt AC, 20 Amp Locking Receptacle — May be used to supply electrical power for the operation of 110 and/or 220 Volt AC, 20 Amp, single phase, 60 Hz electrical lighting, appliance, tool and motor loads.

Air Cleaner — Protects engine by filtering dust and debris out of intake air.

Choke Lever — Used when starting a cold engine.

Double Pole Circuit Breaker (AC) — A double pole circuit breaker is provided to protect all receptacles and generator against electrical overload.

Petrol Tank — Capacity of 17 l (4.5 U.S. gallons).

Petrol Valve — Used to turn petrol supply on and off to engine.

Grounding Fastener — Consult your local agency having jurisdiction for grounding requirements in your area.

Hour Meter — Displays and records how many hours your generator has run (up to 9,999.9).

Oil Fill Cap — Add oil to engine here.

Recoil Starter — Used for starting the engine.

Rocker Switch — Set switch to “On” prior to using recoil starter. Set switch to “Off” to switch off generator.

Spark Arrester Muffler — Exhaust muffler lowers engine noise and is equipped with a spark arrester screen.



ASSEMBLY

Your generator requires some assembly and is ready for use after it has been properly serviced with the recommended oil and petrol.

Remove Generator From Carton

1. Set the carton on a rigid flat surface.
2. Open carton completely by cutting each corner from top to bottom.
3. Cut tie holding manual bag to generator and remove everything from carton.

BEFORE STARTING THE ENGINE

Add Engine Oil

- Place generator on a level surface.

CAUTION

Any attempt to crank or start the engine before it has been properly filled with the recommended oil will result in equipment failure.

- Refer to engine manual for oil fill information.
 - Damage to equipment resulting from failure to follow this instruction will void warranty.
- Refer to engine operator's manual and follow oil recommendations and instructions.

NOTE: Check oil often during engine break-in. Refer to engine operator's manual for recommendations.

NOTE: The generator assembly rotates on a prelubricated and sealed ball bearing that requires no additional lubrication for the life of the bearing.

Add Petrol

NOTE: This engine is certified to operate on petrol only. It will not operate on paraffin, diesel or other fuels.



WARNING



Petrol and its vapors are extremely flammable and explosive.



Fire or explosion can cause severe burns or death.

WHEN ADDING PETROL

- Turn generator OFF and let it cool at least 2 minutes before removing petrol cap. Loosen cap slowly to relieve pressure in tank.
- Fill petrol tank outdoors.
- DO NOT overfill tank. Allow space for petrol expansion.
- Keep petrol away from sparks, open flames, pilot lights, heat, and other ignition sources.
- DO NOT light a cigarette or smoke.

1. Use clean, fresh, regular UNLEADED petrol with a minimum of 85 octane. DO NOT use petrol which contains Methanol. DO NOT mix oil with petrol.

IMPORTANT: DO NOT use fuel containing more than 15% alcohol.

2. Clean area around petrol fill cap, remove cap.
3. Slowly add petrol until level reaches bottom of petrol strainer. Be careful not to overfill. Allow about 38 mm (1.5") of tank space for petrol expansion as shown in Figure 1.

Figure 1 — Typical Petrol Expansion Space

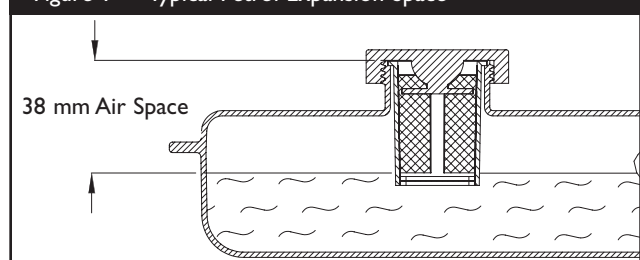

NOTE: Occasionally clear the petrol strainer of any dirt, rust, or other particulate matter.

4. Install petrol cap and wait for any spilled petrol to evaporate.



USING THE GENERATOR

System Ground

The generator has a system ground that connects the generator frame components to the ground terminals on the AC output receptacles. The system ground is connected to the AC neutral wire (see “Equipment Description”, earlier in this manual).

Special Requirements

There may be National regulations, local codes, or ordinances that apply to the intended use of the generator. Please consult a qualified electrician, electrical inspector, or the local agency having jurisdiction.

- In some areas, generators are required to be registered with local utility companies.
- If the generator is used at a construction site, there may be additional regulations which must be observed.

Connecting to a Building’s Electrical System

Connections for standby power to a building’s electrical system must be made by a qualified electrician. The connection must isolate the generator power from utility power, and must comply with all applicable laws and electrical codes.

WARNING

Generator produces powerful voltage.
Failure to isolate generator from power utility can result in death or injury to electric utility workers due to backfeed of electrical energy.

- When using generator for backup power, notify utility company. Use approved transfer equipment to isolate generator from electric utility.
- Use a ground fault circuit interrupter (GFCI) in any damp or highly conductive area, such as metal decking or steel work.
- DO NOT touch bare wires or receptacles.
- DO NOT use generator with electrical cords which are worn, frayed, bare or otherwise damaged.
- DO NOT operate generator in the rain or wet weather.
- DO NOT handle generator or electrical cords while standing in water, while barefoot, or while hands or feet are wet.
- DO NOT allow unqualified persons or children to operate or service generator.

Generator Location

Generator Clearance

WARNING

Exhaust heat/gases can ignite combustibles, structures or damage fuel tank causing a fire.

- Keep at least 1.5 m (5 ft.) clearance on all sides of generator including overhead.

Place generator in a well ventilated area, which will allow for removal of deadly exhaust gas. Do not place generator where exhaust gas could accumulate and enter inside or be drawn into a potentially occupied building. Ensure exhaust gas is kept away from any windows, doors, ventilation intakes or other openings that can allow exhaust gas to collect in a confined area (Figure 2). Prevailing winds and air currents should be taken into consideration when positioning generator.

WARNING

Running generator gives off carbon monoxide, an odorless, colorless, poison gas.
Breathing carbon monoxide can cause nausea, fainting or death.

- Operate generator ONLY outdoors.
- Keep exhaust gas from entering a confined area through windows, doors, ventilation intakes or other openings.
- DO NOT operate generator inside any building or enclosure (even if doors or windows are open), including the generator compartment of a recreational vehicle (RV).

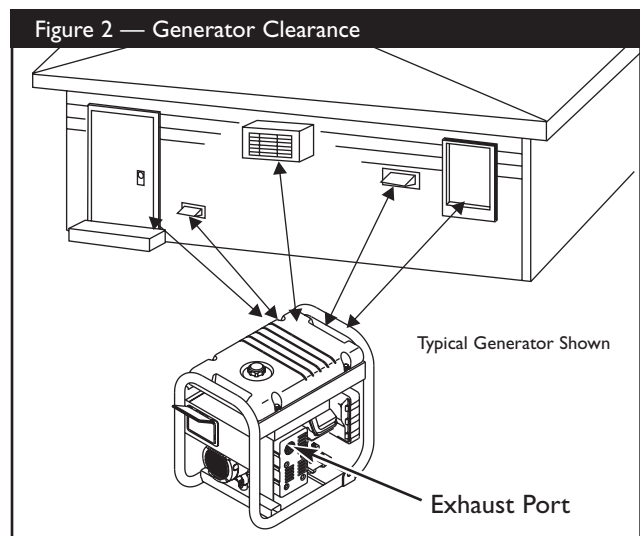

OPERATING THE GENERATOR

Starting the Engine

Disconnect all electrical loads from the generator. Use the following start instruction steps in numerical order:

1. Make sure unit is on a level surface.

IMPORTANT: Failure to start and operate unit on a level surface will cause the unit not to start or shut down during operation.

2. Turn petrol valve to “On” position (Figure 4).

Figure 4 — Petrol Valve

Petrol Valve is shown in “On” position

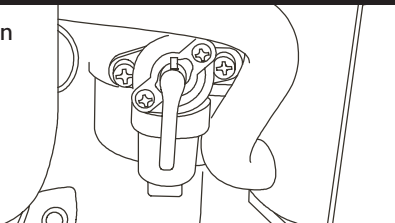

3. Start engine according to instructions given in engine operator’s manual.

WARNING



Rapid retraction of starter cord (kickback) will pull hand and arm toward engine faster than you can let go.

Broken bones, fractures, bruises or sprains could result.

- When starting engine, pull cord slowly until resistance is felt and then pull rapidly to avoid kickback.
- NEVER start or stop engine with electrical devices plugged in and turned on.

NOTE: If engine starts after 3 pulls but fails to run, or if unit shuts down during operation, make sure unit is on a level surface and check for proper oil level in crankcase. This unit may be equipped with a low oil protection device. See engine operator’s manual.

WARNING



Running engines produce heat. Temperature of muffler and nearby areas can reach or exceed 65°C (150°F).



Severe burns can occur on contact.

Exhaust heat/gases can ignite combustibles, structures or damage petrol tank causing a fire.

- DO NOT touch hot surfaces and avoid hot exhaust gases.
- Allow equipment to cool before touching.
- Keep at least 1.5 m (5 ft.) clearance on all sides of generator including overhead.

Connecting Electrical Loads

- Let engine stabilize and warm up for a few minutes after starting.
- Plug in and turn on the desired 110 and/or 220 Volt AC, single phase, 60 Hz electrical loads.
- DO NOT connect 220 Volt loads to the 110 Volt duplex receptacles.
- DO NOT connect 3-phase loads to the generator.
- DO NOT connect 50 Hz loads to the generator.
- **DO NOT OVERLOAD THE GENERATOR.** See “Don’t Overload Generator”.

CAUTION

Exceeding generators wattage/ampere capacity can damage generator and/or electrical devices connected to it.

- See “Don’t Overload Generator”.
- Start generator and let engine stabilize before connecting electrical loads.
- Connect electrical loads in OFF position, then turn ON for operation.
- Turn electrical loads OFF and disconnect from generator before stopping generator.

Stopping the Engine

1. Turn **OFF** and unplug **ALL** electrical loads from generator panel receptacles. NEVER start or stop engine with electrical devices plugged in and turned **ON**.
2. Let engine run at no-load for several minutes to stabilize internal temperatures of engine and generator.
3. Move fuel valve to “Off” position.
4. Turn engine off according to instructions given in the engine operator’s manual.

COLD WEATHER OPERATION

Under certain weather conditions (temperatures below 4°C [40°F] combined with high humidity), your generator may experience icing of the carburetor and/or the crankcase breather system. To reduce this problem, you need to perform the following:

1. Make sure generator has clean, fresh petrol.
2. Open petrol valve (turn valve to open position).
3. Use SAE 5W-30 oil (synthetic preferred, see engine operator’s manual).



4. Check oil level daily or after every eight (8) hours of operation.
5. Maintain generator following "Maintenance Schedule" in engine operator's manual.
6. Shelter unit from elements.

6. Start generator as described in the section "Starting the Engine", then place carton over generator. Keep at least 1.5 m (5 ft.) clearance on all sides of generator including overhead with shelter in place.

Creating a Temporary Shelter

1. In an emergency, use the original shipping carton.
2. Cut off top carton flaps and one long side of carton to expose muffler side of unit. If required, tape up other sides of carton to fit over generator as shown in Figure 4.

Figure 4 — Permanent Cold Weather Shelter

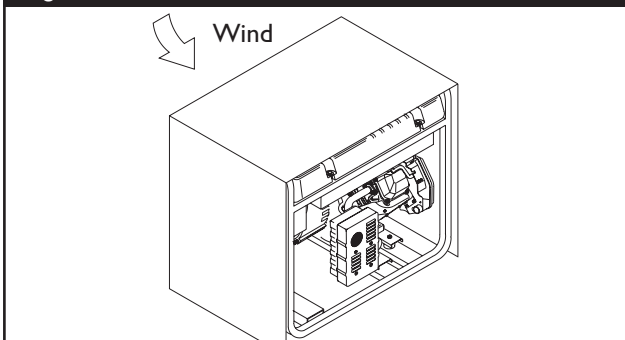

NOTE: If required, remove wheel kit to fit carton over generator as shown in Figure 4.

3. Cut appropriate slots to access receptacles of unit.
4. Face exposed end away from wind and elements.
5. Locate generator as described in the section "Generator Location". Keep exhaust gas from entering a confined area through windows, doors, ventilation intakes or other openings.

WARNING



Running generator gives off carbon monoxide, an odorless, colorless, poison gas.

Breathing carbon monoxide can cause nausea, fainting or death.

- Operate generator **ONLY** outdoors.
- Keep exhaust gas from entering a confined area through windows, doors, ventilation intakes or other openings.
- **DO NOT** operate generator inside any building or enclosure (even if doors or windows are open), including the generator compartment of a recreational vehicle (RV).

WARNING



Running engines produce heat. Temperature of muffler and nearby areas can reach or exceed 65°C (150°F).



Severe burns can occur on contact.

Exhaust heat/gases can ignite combustibles, structures or damage petrol tank causing a fire.

- **DO NOT** touch hot surfaces and avoid hot exhaust gases.
 - Allow equipment to cool before touching.
 - Keep at least 1.5 m (5 ft.) clearance on all sides of generator including overhead.
 - Remove shelter when temperatures are above 4°C [40°F].
7. Remove shelter when temperatures are above 4°C [40°F].
 8. Turn engine **OFF** and let cool two (2) minutes before refueling. Wipe up any spilled fuel.

Creating a Permanent Shelter

1. Build a structure that will enclose three sides and the top of the generator, making sure muffler side of generator is exposed.

NOTE: Structure should hold enough heat created by the generator to prevent icing problem.

2. **DO NOT** enclose generator any more than shown in Figure 4.

NOTE: If a wheel kit is installed on the generator, enlarge shelter accordingly.

3. Follow steps 3 through 8 as described previously in "Creating a Temporary Shelter".

RECEPTACLES

A double pole rocker switch circuit breaker is provided to protect all the receptacles and generator against electrical overload.

CAUTION

Receptacles may be marked with rating value greater than generator output capacity.

- NEVER attempt to power a device requiring more amperage than generator or receptacle can supply.
- DO NOT overload the generator. See "Don't Overload Generator".

110/220 Volt AC, 20 Amp Locking Receptacle

Use a NEMA L14-20 plug with this receptacle. Connect a 4-wire cord set rated for 250 Volts AC at 20 Amps (or greater) (Figure 5). You can use the same 4-wire cord if you plan to run a 120 Volt load.

Figure 5 — 120/240 Volt AC, 20 Amp Receptacle

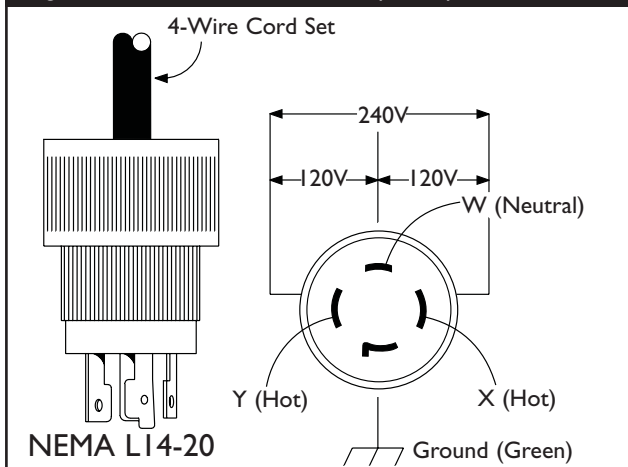

This receptacle powers 110/220 Volt AC, 60 Hz, single phase loads requiring up to 1,800 watts of power at 15.0 Amps for 110 Volts; 3,600 watts of power (3.6 kW) at 15.0 Amps for 220 Volts. The outlet is protected by a double pole rocker switch circuit breaker.

IMPORTANT: This generator's locking receptacle is not protected by a Ground Fault Circuit Interrupter (GFCI).

110 Volt AC, 15 Amp, GFCI Duplex Receptacles

Each duplex receptacle (Figure 6) is protected against overload by a push-to-reset circuit breaker.

Figure 6 — 120 Volt, 15 Amp GFCI Duplex Receptacle

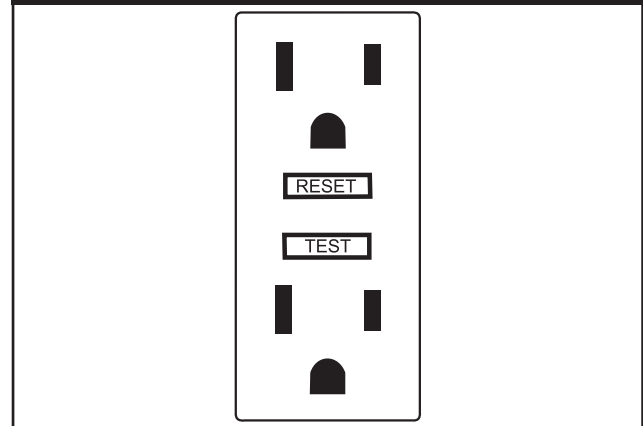

NOTE: If the double pole circuit breaker is tripped, the duplex receptacles are disconnected.

Use each receptacle to operate 110 Volt AC, single-phase, 60 Hz electrical loads requiring up to 1,800 watts (1.8 kW) at 15 Amps of current. Use cord sets that are rated for 125 Volt AC loads at 15 Amps (or greater). Inspect cord sets before each use.



Ground Fault Protection

The duplex receptacles are equipped with Ground Fault Circuit Interrupter (GFCI) protection. This device meets applicable federal, state and local codes. The generator's locking receptacle is not protected by a GFCI.

The GFCI protects against electrical shock that may be caused if your body becomes a path which electricity travels to reach the ground. This could happen if you touch a "Live" appliance or wire, or are touching plumbing or other materials that connect to the ground.



WARNING



Generator produces powerful voltage.

- The GFCI will not protect you against the following situations:
 - Line-to-line shocks;
 - Current overloads or line-to-line short circuits.
- The fuse or circuit breaker at the control panel must provide such protection.

When protected by a GFCI, one may still feel a shock, but the GFCI should cut current off quickly enough so that a person in normal health should not suffer any serious electrical injury.

Testing the GFCI

Test your GFCI outlet prior to each use, as follows:



CAUTION

The "Reset" button does not pop out or the test lamp remains lit when the "Reset" button is popped out.

- DO NOT use any outlets on the circuit.
- Call or take your generator to a local service center.
- Push the black "**Test**" button. The red "**Reset**" button should pop out, which should allow no power to reach the outlet. Use a test lamp in each outlet to test this.
- If the GFCI tests good, restore power by pressing the "**Reset**" button firmly until it is fully in place and locks in that position. **If the GFCI outlet does not reset properly, do not use the outlet. Call or take your generator to a local service center.**
- If the GFCI trips by itself at any time, reset and test the outlet. **If the reset button does not pop out when the test button is pressed, do not use the outlet. Call or take your generator to a local service center.**



DON'T OVERLOAD GENERATOR

Capacity

You must make sure your generator can supply enough rated (running) and surge (starting) watts for the items you will power at the same time. Follow these simple steps:

1. Select the items you will power at the same time.
2. Total the rated (running) watts of these items. See Figure 6.
3. Estimate how many surge (starting) watts you will need. Surge wattage is the short burst of power needed to start electric motor-driven tools or appliances. Total surge watts is estimated by adding only the one item with the highest additional surge watts to the total rated watts from step 2.

For Example:

Tool or Appliance	Rated (Running) Watts	Additional Surge (Starting) Watts
Refrigerator	800	1600
Deep Freezer	500	500
Television	500	-
Light (75 Watts)	75	-
	1875 Total Running Watts	1600 Highest Surge Watts

Total Rated (Running) Watts = 1875

Highest Additional Surge Watts = 1600

Total Generator Output Required = 3475

Power Management

It is important to take care when adding electrical loads to your generator. The correct and safe way to manage generator power is to sequentially add loads as follows:

1. With nothing connected to the generator, start the engine as described in this manual.
2. Plug in and turn on the first load, preferably the largest load you have.
3. Permit the generator output to stabilize (engine runs smoothly and attached device operates properly).

4. Plug in and turn on the next load.
5. Again, permit the generator to stabilize.
6. Repeat steps 4 and 5 for each additional load.

NEVER add more loads than generator capacity. Take special care to consider surge loads in generator capacity, as described above.

Figure 6 - Wattage Reference Chart

Tool or Appliance	Rated* (Running) Watts	Additional Surge (Starting) Watts
Essentials		
Light Bulb - 75 watt	75	-
Deep Freezer	500	500
Sump Pump	800	1200
Refrigerator/Freezer - 18 Cu. Ft.	800	1600
Water Well Pump - 1/3 HP	1000	2000
Heating/Cooling		
Window Fan	300	600
Furnace Fan Blower - 1/2 HP	800	1300
Kitchen		
Microwave Oven - 1000 Watt	1000	-
Coffee Maker	1500	-
Electric Stove - Single Element	1500	-
Hot Plate	2500	-
Family Room		
Stereo Receiver	450	-
Television - 27"	500	-
Personal Computer w/17" monitor	800	-
Other		
AM/FM Clock Radio	300	-
Electric Water Heater - 40 Gallon	4000	-
Quartz Halogen Work Light	1000	-
Airless Sprayer - 1/3 HP	600	1200
Reciprocating Saw	960	960
Electric Drill - 1/2 HP	1000	1000
Circular Saw - 7 1/4"	1500	1500
Miter Saw - 10"	1800	1800
Table Saw/Radial Arm Saw - 10"	2000	2000
Air Compressor - 1-1/2 HP	2500	2500

*Wattages listed are approximate only. Check tool or appliance for actual wattage.



SPECIFICATIONS

Starting Wattage	5,400 Watts
Wattage	3,600 Watts
Rated AC Load Current	
At 110 Volts	30.0 Amps
At 220 Volts	15.0 Amps
Phase	1-phase
Rated Frequency	60 Hertz
Petrol Tank Capacity	17 l (4.5 U.S. gallons)
Shipping Weight	62 kg. (137 lbs.)

GENERAL MAINTENANCE RECOMMENDATIONS

The Owner/Operator is responsible for making sure that all periodic maintenance tasks are completed on a timely basis; that all discrepancies are corrected; and that the unit is kept clean and properly stored. **NEVER operate a damaged or defective generator.**

NOTE: Should you have questions about replacing components on your Briggs & Stratton Power Products generator, please contact your local service center for assistance.

Engine Maintenance

See engine operator's manual for instructions.

 CAUTION
Avoid prolonged or repeated skin contact with used motor oil.
<ul style="list-style-type: none"> • Used motor oil has been shown to cause skin cancer in certain laboratory animals. • Thoroughly wash exposed areas with soap and water.





KEEP OUT OF REACH OF CHILDREN.
DON'T POLLUTE. CONSERVE RESOURCES.
RETURN USED OIL TO COLLECTION CENTERS.

Generator Maintenance

Generator maintenance consists of keeping the unit clean and dry. Operate and store the unit in a clean dry environment where it will not be exposed to excessive dust, dirt, moisture or any corrosive vapors. Cooling air slots in the generator must not become clogged with snow, leaves or any other foreign material.

NOTE: DO NOT use a garden hose to clean generator. Water can enter engine fuel system and cause problems. In addition, if water enters generator through cooling air slots, some of the water will be retained in voids and cracks of the rotor and stator winding insulation. Water and dirt buildup on the generator internal windings will eventually decrease the insulation resistance of these windings.

 WARNING	
	Unintentional sparking can result in fire or electric shock.
	
WHEN ADJUSTING OR MAKING REPAIRS TO YOUR GENERATOR	
<ul style="list-style-type: none"> • Disconnect the spark plug wire from the spark plug and place the wire where it cannot contact spark plug. 	
WHEN TESTING FOR ENGINE SPARK	
<ul style="list-style-type: none"> • Use approved spark plug tester. • DO NOT check for spark with spark plug removed. 	

Generator Cleaning

- Use a damp cloth to wipe exterior surfaces clean.

CAUTION
Improper treatment of generator can damage it and shorten its life.
<ul style="list-style-type: none"> • DO NOT expose generator to excessive moisture, dust, dirt, or corrosive vapors. • DO NOT insert any objects through cooling slots.

- Use a soft bristle brush to loosen caked on dirt or oil.
- Use a vacuum cleaner to pick up loose dirt and debris.
- Use low pressure air (not to exceed 25 psi) to blow away dirt. Inspect cooling air slots and opening on generator. These openings must be kept clean and unobstructed.



STORAGE

The generator should be started at least once every seven days and allowed to run at least 30 minutes. If this cannot be done and you must store the unit for more than 30 days, use the following guidelines to prepare it for storage.

Generator Storage

- Clean the generator as outlined in “Generator Cleaning”.
- Check that cooling air slots and openings on generator are open and unobstructed.



WARNING

Storage covers can be flammable.

- DO NOT place a storage cover over a hot generator.
- Let equipment cool for a sufficient time before placing the cover on the equipment.

Engine Storage

See engine owner's manual for instructions.

Other Storage Tips

- To prevent gum from forming in petrol system or on essential carburetor parts, add petrol stabilizer into petrol tank and fill with fresh petrol. Run the unit for several minutes to circulate the additive through the carburetor. The unit and petrol can then be stored for up to 24 months. Petrol stabilizer can be purchased locally.
- DO NOT store petrol from one season to another unless it has been treated as described above.
- Replace petrol container if it starts to rust. Rust and/or dirt in petrol can cause problems if it's used with this unit.
- Store unit in a clean and dry area.



TROUBLESHOOTING

Problem	Cause	Solution
Engine is running, but no AC output is available.	<ol style="list-style-type: none"> 1. Circuit breaker is open. 2. Poor connection or defective cord set. 3. Connected device is bad. 4. Fault in generator. 	<ol style="list-style-type: none"> 1. Reset circuit breaker. 2. Check and repair. 3. Connect another device that is in good condition. 4. Contact Briggs and Stratton service facility.
Engine runs good but bogs down when loads are connected.	<ol style="list-style-type: none"> 1. Short circuit in a connected load. 2. Generator is overloaded. 3. Shorted generator circuit. 	<ol style="list-style-type: none"> 1. Disconnect shorted electrical load. 2. See "Don't Overload Generator". 3. Contact Briggs and Stratton service facility.
Engine will not start; or starts and runs rough.	<ol style="list-style-type: none"> 1. Out of petrol. 2. Petrol valve is in the "Closed" position. 3. Low oil level. 	<ol style="list-style-type: none"> 1. Fill petrol tank. 2. Turn petrol valve to the "Open" position. 3. Fill crankcase to proper level.
Engine shuts down during operation.	<ol style="list-style-type: none"> 1. Out of petrol. 2. Low oil level. 3. Generator tipped at angle. 	<ol style="list-style-type: none"> 1. Fill petrol tank. 2. Fill crankcase to proper level. 3. Place generator on level surface.
Engine lacks power.	Load is too high.	See "Don't Overload Generator".

BRIGGS & STRATTON POWER PRODUCTS GROUP, LLC PORTABLE GENERATOR OWNER WARRANTY POLICY

Effective February 1, 2006 replaces all undated Warranties and all Warranties dated before February 1, 2006

LIMITED WARRANTY

Briggs & Stratton Power Products Group, LLC will repair or replace, free of charge, any part(s) of the portable generator that is defective in material or workmanship or both. Transportation charges on product submitted for repair or replacement under this warranty must be borne by purchaser. This warranty is effective for the time periods and subject to the conditions stated below. For warranty service, find the nearest Authorized Service Dealer in our dealer locator map at www.briggspowerproducts.com.

THERE IS NO OTHER EXPRESS WARRANTY. IMPLIED WARRANTIES, INCLUDING THOSE OF MERCHANTABILITY AND FITNESS FOR A PARTICULAR PURPOSE, ARE LIMITED TO ONE YEAR FROM PURCHASE, OR TO THE EXTENT PERMITTED BY LAW ANY AND ALL IMPLIED WARRANTIES ARE EXCLUDED. LIABILITY FOR INCIDENTAL OR CONSEQUENTIAL DAMAGES ARE EXCLUDED TO THE EXTENT EXCLUSION IS PERMITTED BY LAW. Some states or countries do not allow limitations on how long an implied warranty lasts, and some states or countries do not allow the exclusion or limitation of incidental or consequential damages, so the above limitation and exclusion may not apply to you. This warranty gives you specific legal rights and you may also have other rights which vary from state to state or country to country.

WARRANTY PERIOD

Consumer Use	1 year
Commercial Use	1 year

The warranty period begins on the date of purchase by the first retail end user, and continues for the period of time stated above. "Consumer Use" means personal residential household use by a retail consumer. "Commercial Use" means all other uses, including use for commercial, income producing or rental purposes. Once equipment has experienced commercial use, it shall thereafter be considered as commercial use for purposes of this warranty. Equipment used for prime power in place of utility are not applicable to this warranty.

NO WARRANTY REGISTRATION IS NECESSARY TO OBTAIN WARRANTY ON BRIGGS & STRATTON PRODUCTS. SAVE YOUR PROOF OF PURCHASE RECEIPT. IF YOU DO NOT PROVIDE PROOF OF THE INITIAL PURCHASE DATE AT THE TIME WARRANTY SERVICE IS REQUESTED, THE MANUFACTURING DATE OF THE PRODUCT WILL BE USED TO DETERMINE THE WARRANTY PERIOD.

ABOUT YOUR WARRANTY

We welcome warranty repair and apologize to you for being inconvenienced. Any Authorized Service Dealer may perform warranty repairs. Most warranty repairs are handled routinely, but sometimes requests for warranty service may not be appropriate. For example, warranty service would not apply if equipment damage occurred because of misuse, lack of routine maintenance, shipping, handling, warehousing or improper installation. Similarly, the warranty is void if the manufacturing date or the serial number on the portable generator has been removed or the equipment has been altered or modified. During the warranty period, the Authorized Service Dealer, at its option, will repair or replace any part that, upon examination, is found to be defective under normal use and service. This warranty will not cover the following repairs and equipment:

- **Normal Wear:** Outdoor Power Equipment, like all mechanical devices, needs periodic parts and service to perform well. This warranty does not cover repair when normal use has exhausted the life of a part or the equipment.
- **Installation and Maintenance:** This warranty does not apply to equipment or parts that have been subjected to improper or unauthorized installation or alteration and modification, misuse, negligence, accident, overloading, overspeeding, improper maintenance, repair or storage so as, in our judgment, to adversely affect its performance and reliability. This warranty also does not cover normal maintenance such as adjustments, fuel system cleaning and obstruction (due to chemical, dirt, carbon, lime, etc.).
- **Other Exclusions:** This warranty excludes wear items such as o-rings, filters, etc., or malfunctions resulting from accidents, abuse, modifications, alterations, or improper servicing or freezing or chemical deterioration. Accessory parts such as generator adapter cord sets and storage covers are excluded from the product warranty. This warranty excludes failures due to acts of God and other force majeure events beyond the manufacturers control. Also excluded is used, reconditioned, and demonstration equipment; equipment used for prime power in place of utility power and equipment used in life support applications.

BRIGGS & STRATTON POWER PRODUCTS GROUP, LLC
JEFFERSON, WI, USA

Free Manuals Download Website

<http://myh66.com>

<http://usermanuals.us>

<http://www.somanuals.com>

<http://www.4manuals.cc>

<http://www.manual-lib.com>

<http://www.404manual.com>

<http://www.luxmanual.com>

<http://aubethermostatmanual.com>

Golf course search by state

<http://golfingnear.com>

Email search by domain

<http://emailbydomain.com>

Auto manuals search

<http://auto.somanuals.com>

TV manuals search

<http://tv.somanuals.com>