

MFC-8220

At your side.
brother

Table of contents

1

Using the MFC as a printer	1-1
Using the Brother MFC printer driver.....	1-1
How to print your original document	1-2
Manual Duplex Printing.....	1-2
Face-down output tray.....	1-3
Printing on plain paper.....	1-4
The manual feed tray.....	1-4
Printing on thicker paper and card stock	1-5
The manual feed tray.....	1-5
Printing on envelopes	1-7
Simultaneous printing and faxing.....	1-10
Printer operation keys.....	1-10
Job Cancel.....	1-10
Secure key.....	1-10
Setting the Emulation Selection.....	1-12
Printing the Internal Font List.....	1-13
Printing the Print Configuration List	1-13
Restoring default settings	1-13

2

Printer driver settings	2-1
Printer driver settings.....	2-1
How to access the printer driver settings.....	2-1
Features in the Brother Native Driver	2-2
Basic tab	2-2
Paper Size	2-3
Multiple Page.....	2-3
Orientation	2-3
Copies	2-4
Media Type.....	2-4
Advanced tab.....	2-6
Print Quality.....	2-7
Duplex	2-8
Watermark	2-9
Page Setting.....	2-11
Device Options	2-12
Accessories tab	2-17
Support tab	2-19
Features in the PS Brother (PostScript®) printer driver (For Windows®).....	2-20
Ports tab	2-21

Device Settings tab.....	2-21
Layout tab.....	2-22
Paper / Quality tab.....	2-23
Advanced Options	2-24

3

How to scan using Windows®	3-1
Scanning an original document	3-1
TWAIN compliant.....	3-1
How to access the Scanner.....	3-2
Scanning an original document into the PC	3-3
Scanning a whole page	3-3
Pre-Scanning to crop a portion you want to scan	3-4
Settings in the Scanner window	3-6
Image Type	3-6
Resolution	3-6
Scan Type	3-7
Brightness	3-7
Contrast.....	3-7
Document Size	3-8
Scanning an original document (For Windows® XP only)	3-10
WIA compliant	3-10
How to access the scanner	3-10
Scanning an original document into the PC	3-11
Brother Scanner Utility	3-13
Using the Scan key (For USB or Parallel interface cable users).....	3-14
Scan to E-mail	3-15
Scan to Image	3-15
Scan to OCR	3-16
Scan to File.....	3-16
Using ScanSoft® PaperPort® and TextBridge® OCR.....	3-17
Viewing items	3-18
Organizing your items in folders	3-19
Quick links to other applications	3-20
ScanSoft® TextBridge® OCR lets you convert image text into text you can edit.....	3-21
You can Import items from other applications	3-22
You can Export items in other formats	3-22
Exporting an image file	3-22
How to Uninstall PaperPort® and ScanSoft® TextBridge®	3-23

Using the Brother Control Center	4-1
Brother MFL-Pro Control Center.....	4-1
AutoLoad the Brother Control Center	4-2
How to turn off AutoLoad.....	4-2
Brother Control Center features.....	4-3
Auto Configuration	4-3
Scan key operations	4-4
Copy operations.....	4-4
PC-Fax operation.....	4-4
Scanner settings for Scan, Copy and PC-Fax buttons	4-5
Global settings.....	4-5
Setting up the scanner configurations	4-6
Perform an operation from the Control Center screen.....	4-7
Scan to File.....	4-8
To access Scan to File Configurations screen	4-8
Scanner settings.....	4-8
Destination folder.....	4-9
Scan to E-mail	4-10
To access Scan to E-mail Configurations screen.....	4-10
Scanner settings.....	4-11
E-mail application	4-11
Send to Options.....	4-12
Scan to OCR (Word Processor)	4-13
To access Scan to OCR Configurations screen	4-13
Scanner settings.....	4-14
Word Processor.....	4-14
Scan to Image.....	4-16
To access Scan to Image Configurations screen	4-16
Scanner Settings	4-17
Target Application.....	4-17
Copy	4-18
To access the Copy Configurations screen.....	4-18
Scanner settings.....	4-19
Number of copies.....	4-19
Send a fax.....	4-20
To access the Send a fax Configurations screen	4-20
Scanner settings.....	4-20
PC-FAX Settings.....	4-21

Using the Windows®-Based Brother SmartUI Control Center ...	5-1
Brother SmartUI Control Center	5-1
AutoLoad the Brother Control Center	5-2
How to turn off AutoLoad	5-2
Brother Control Center features	5-3
Auto Configuration	5-4
Hardware Section: Changing the Scan to button configuration	5-5
Scan to E-mail	5-6
Scan to File	5-7
Scan to Image	5-8
Scan to OCR	5-10
Software Section	5-12
Scan	5-13
Copy	5-13
Fax	5-14
Custom	5-14
Scan to File	5-15
Scan to E-mail	5-17
File attachments	5-19
Scanner settings	5-20
Scan to OCR (Word Processing program)	5-21
Scan to Graphics application (example: Microsoft Paint)	5-23
Copy	5-25
Fax setting (PC-Fax using the Brother Fax Driver)	5-27
FAX settings	5-28
Custom: User-defined buttons	5-29
Customizing a user-defined button	5-29
1. Select the Scan Action	5-29
2. Select Configuration for the Scan Type	5-30
3. Select Scan Settings	5-34

Using MFC Remote Setup	6-1
MFC Remote Setup	6-1

Using Brother PC-FAX software	7-1
PC-FAX sending	7-1
Setting up user information	7-2
Sending setup	7-3
Outside line access	7-4
Include header	7-4
Address Book file	7-4

User interface	7-5
Simple style	7-5
Facsimile style	7-5
Speed-Dial setup	7-6
The Address Book	7-7
Setting up a Member in the Address Book	7-8
Setting up a Group for Broadcasting	7-9
Editing Member information	7-10
Deleting a Member or Group	7-10
Exporting the Address Book	7-10
Importing to the Address Book	7-12
Setting up a Cover Page.....	7-14
You can enter information in each field	7-15
Sending a file as a PC-FAX using the Facsimile style	7-16
Redial	7-17
Sending a file as a PC-FAX using the Simple style....	7-17
Setting up PC-FAX receiving (Windows® 95/98/98SE/Me/2000 Professional and Windows NT® WS 4.0 only)	7-19
Running PC-FAX Receiving	7-19
Setting up your PC.....	7-19
Viewing new PC-FAX messages	7-20
Receiving a fax into the PC (Windows® XP only).....	7-21
How to receive a fax automatically	7-21
How to view the received faxes	7-27

8

Using your MFC with a Macintosh®	8-1
Setting up your USB-equipped Apple® Macintosh®	8-1
Using the Brother printer driver with your Apple® Macintosh® (Mac OS® 8.6-9.2)	8-2
Using the Brother Printer Driver with Your Apple® Macintosh® (Mac OS® X).....	8-4
Choosing page setup options	8-4
Specific settings.....	8-5
Using the PS driver with your Apple® Macintosh®	8-6
For Mac OS® 8.6 to 9.2 users.....	8-7
For Mac OS® X users	8-11
Sending a fax from your Macintosh® application	8-14
For Mac OS® 8.6-9.2 users	8-14
For Mac OS® X users	8-16
Drag a vCard from the Mac OS® X Address Book application	8-18

Using the Brother TWAIN scanner driver with your Macintosh®	8-20
Accessing the scanner	8-20
Scanning an image into your Macintosh®	8-21
Scanning a whole page	8-21
Pre-Scanning an image	8-22
Settings in the Scanner window	8-23
Image	8-23
Scanning Area	8-25
Adjusting the Image	8-26
Using Presto!® PageManager®	8-27
Highlights	8-27
System requirements	8-28
Technical Support	8-28
MFC Remote Setup (Mac OS® X)	8-29

9

Network Scanning	9-1
Network License	9-1
Registering your PC with the MFC	9-2
Using the Scan key	9-5
Scan to E-mail (PC)	9-5
Scan to E-mail (E-mail server)	9-6
Scan to Image	9-7
Scan to OCR	9-8
Scan to File	9-9

10

Brother Network PC-FAX software	10-1
Enable Network PC-FAX	10-1
Sending setup	10-2
Extra options in Address Book	10-3
Using the Brother Network PC-FAX software	10-4
Quick Tips:	10-4
Sending a Network PC-FAX from your Macintosh® application	10-5
For Mac OS® 8.6-9.2 users	10-5
For Mac OS® X 10.1/10.2.1-10.3 or greater users	10-5

Index	I-1
--------------------	------------

1

Using the MFC as a printer

Using the Brother MFC printer driver

A Printer Driver is software that translates data from the format used by a computer into the format required by a particular printer, using a printer command language or page description language.

The printer drivers are on the CD-ROM we have supplied. Install the drivers first by following the Quick Setup Guide. Also, the latest printer driver can be downloaded from the Brother Solutions Center at:

<http://solutions.brother.com>

Windows® Printing

The dedicated printer driver and TrueType™ compatible fonts for Microsoft® Windows® 95/98/98SE/Me/2000 Professional/XP and Windows NT® workstation 4.0 are available on the CD-ROM supplied with your MFC. You can install them easily into your Windows® system using our installer program. The driver supports our unique compression mode to enhance printing speed in Windows® applications, and allows you to set various printer settings, including economy printing mode and custom paper size.

Popular Printer Emulation Support

The MFC supports HP LaserJet (PCL level 6) and BR-Script (PostScript® 3™ language emulation) printer emulation mode. If you use DOS application software, you can use HP LaserJet (PCL level 6) and BR-Script (PostScript® 3™ language emulation) emulation mode for printer operations.

How to print your original document

When the MFC receives data from your computer, it begins printing by picking up paper from the paper tray. The paper tray can feed many types of paper and envelopes.

- 1 From your computer select the Print command.
If your computer is also connected to any other printers, select **MFC-8220 (USB) Printer** or **Brother MFC-8220** as your printer driver from the Print or Print Settings menu in your software application, and then click on OK to begin printing.
- 2 Your computer sends a print command and data to the MFC.
- 3 The LCD back light will change to orange and the MFC starts to print.

 You can select the paper size and orientation in your application software.

If your application software does not support your custom paper size, select the next largest paper size.

Then adjust the print area by changing the right and left margins in your application software.

Manual Duplex Printing

The MFC prints all the even-numbered pages on one side of the paper first.

Then, the Windows® driver instructs you (with a pop-up message) to reinsert the paper. Before reinserting the paper, straighten it well, or you may get a paper jam. Very thin or very thick paper is not recommended.

We recommend 75 to 90 g/m² (20 to 24 lb) paper.

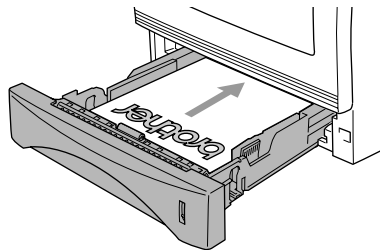

Face-down output tray

The MFC ejects paper with printed surfaces *face down* into the output tray in the front of the MFC. Unfold the support flap to support the printed pages.



When printing transparencies, remove each one from the support flap after it exits the MFC.

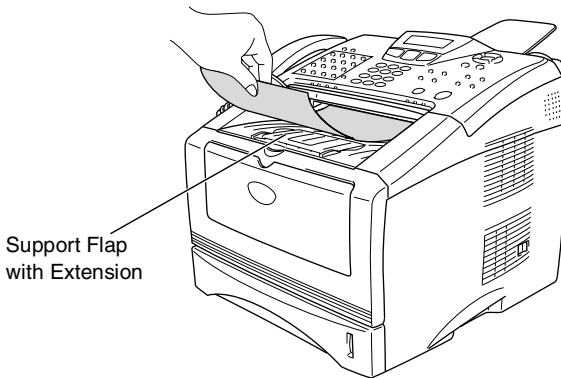

Printing on plain paper

The manual feed tray

 The MFC automatically turns on the Manual Feed mode when you put paper in the manual feed tray.

- 1** Select the **Paper Size, Media Type, Paper Source**, and other settings in the printer driver.

Media Type: Plain Paper

Paper Source: Manual

- 2** Open the manual feed tray. Slide the paper guides to fit the paper size.
- 3** Using both hands put paper in the manual feed tray face up until the front edge of the paper touches the paper feed roller and the MFC grips the paper.

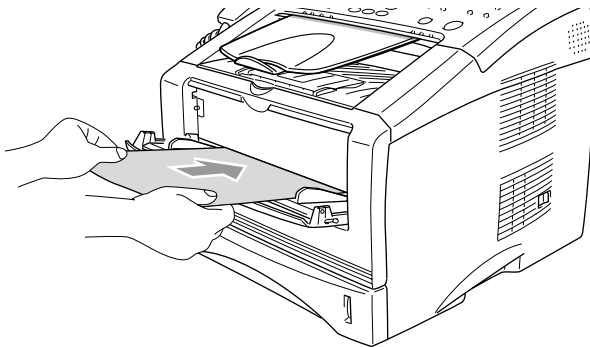

 ■ Make sure that the paper is straight and in the proper position on the manual feed tray. If it is not, the paper may not be fed properly, resulting in a skewed printout or a paper jam.

■ Do not put more than one piece of paper in the manual feed tray at any one time, or it may cause a jam.

- 4** Send the print data to the MFC.
- 5** After the printed page comes out of the MFC, put in the next sheet of paper as in Step 3. Repeat for each page that you want to print.

Printing on thicker paper and card stock

When the back output tray is pulled down, the MFC has a straight paper path from the manual feed tray through to the back of the MFC. Use this paper feed and output method when you want to print on thicker paper or card stock.

The manual feed tray

- 1 Select the **Paper Size**, **Media Type**, **Paper Source**, and other settings in the printer driver.

Media Type: Thick paper or Thicker paper

Paper Source: Manual

- 2 Open the back output tray.

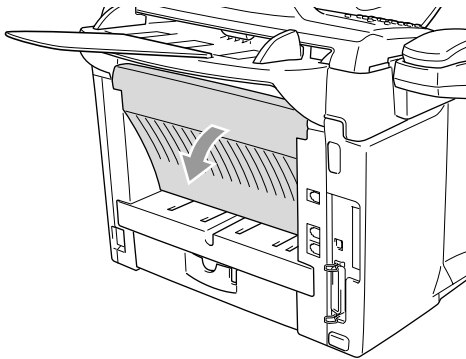

- 3 Open the manual feed tray. Slide the paper guides to fit the paper size.
- 4 Using both hands put the paper in the manual feed tray face up until the front edge of the paper touches the paper feed roller and the MFC grips the paper.



- Make sure that the paper is straight and in the proper position in the manual feed tray. If it is not, the paper may not be fed properly, resulting in a skewed printout or a paper jam.
- Do not put more than one piece of paper in the manual feed tray at any one time, or it may cause a jam.

- 5 Send the print data to the MFC.
- 6 After the printed page comes out of the MFC, put in the next sheet of paper as in Step 4. Repeat for each page that you want to print.
- 7 When you have finished the print job, close the back output tray.

! Caution

Remove each sheet immediately after printing. Stacking the sheets may cause a paper jam or the paper to curl.

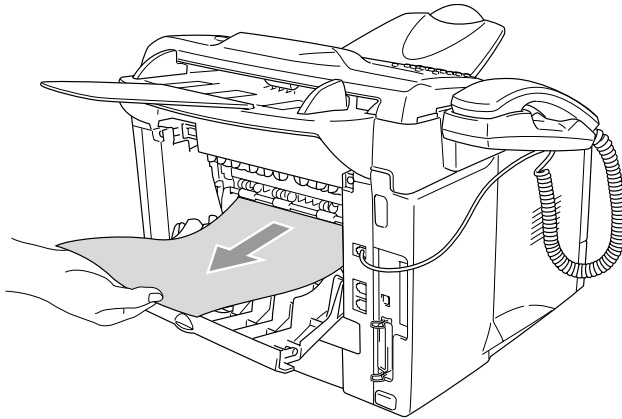

Printing on envelopes

To print on envelopes use manual feed tray



- The MFC automatically turns on the Manual Feed mode when you put paper in the manual feed tray.
- All sides should be properly folded without any wrinkles or creases.

1 Select the **Paper Size, Media Type, Paper Source**, and other settings in the printer driver.

Media Type: Envelope, Env.Thin or Env.Thick

2 Open the back output tray.

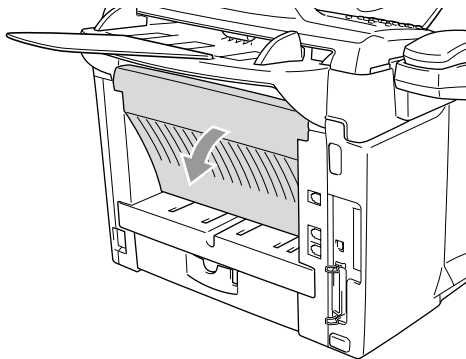

3 Open the manual feed tray. Slide the paper guides to fit the envelope size.



If envelopes are created after they have been printed:

At the back of the MFC, open the back output tray and push down the blue tabs at the left and right hand sides (as shown in the figure on the next page). When you have finished printing your envelopes, close the back output tray to reset the two blue tabs back to their original position.

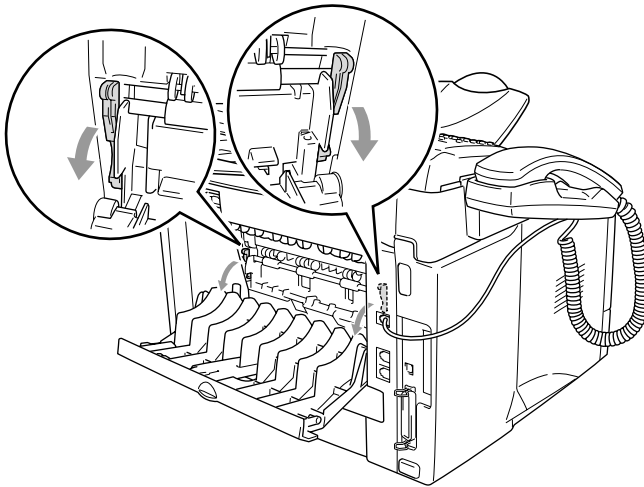

- 4** Using both hands put the envelope in the manual feed tray face up until the front edge of the envelope touches the paper feed roller and the MFC grips the envelope.

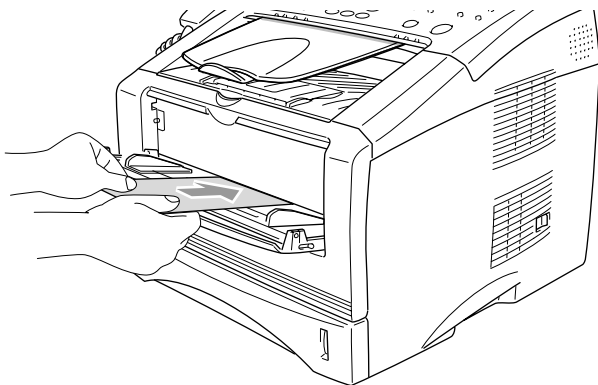

- Make sure the envelope is straight as you insert it in the manual feed tray. If it is not, the envelope may not be fed properly, resulting in a skewed printout or a jam.
 - Do not put more than one envelope in the manual feed tray at any one time, or it may cause a jam.
 - Put the envelope in the manual feed tray, making sure that the side to be printed on is face up in the tray.
- 5** Send the print data to the MFC.
- 6** After the printed envelope comes out of the MFC, the MFC will wait until you put in the next envelope. Repeat Step 4 for each envelope you want to print.
- 7** After you finish the print job, close the back output tray.

Simultaneous printing and faxing

Your MFC can print from your computer while sending or receiving a fax, or while scanning an original document into the computer. Fax sending will not be stopped during PC printing.

Printer operation keys

Job Cancel

You can clear data from the memory by pressing the **Job Cancel** key.

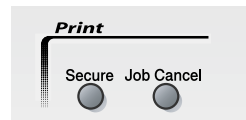

Secure key

Secured data is password protected. Only those people that know the password will be able to print the data. The MFC will not print secure data until the password is entered. After the original document is printed, the data will be cleared from the memory. To use this menu setting, you need to set your password in the printer driver dialog box. (See *Device Options* on page 2-12.)

 The Secure Key setting is not available when using the Brother BR-Script (PostScript® 3™ language emulation) driver.



1 Press **Secure**.

2 Press  or  to select the user name.

User? MIKE	▾
---------------	---

Press **Set**. The LCD displays job selections.

 The LCD displays **No Data!** if there is no secured data in the memory.

3 Press  or  to select the job.
Press **Set**. The LCD prompts you to enter your four-digit password.

Job?
Text1

4 Enter your password using the control panel.



Text1
Password:XXXX

Press **Set**.

5 Press  or  to select Print.

Press **Set**. The MFC prints the data.

—OR—

If you want to delete the secured data, press  or  to select Delete and press **Set**.



- If you turn the MFC power switch off, the secured data saved in memory will be cleared.
- After you print the secured data it will be cleared from memory.

Setting the Emulation Selection

Your MFC will receive print commands in a printer job language or Emulation. Different operating systems and applications will send the print commands in different languages. Your MFC can receive print commands in a variety of emulation's. This MFC has an Automatic Emulation Selection setting. When the MFC receives information from the PC, it automatically chooses the emulation mode. This setting has been set at the factory to AUTO.

You can change the default emulation mode manually by using the control panel.

1 Press **Menu, 4, 1.**

2 Press  or  to select Auto, HP LaserJet or BR-Script 3.

Press **Set.**

3 Press **Stop/Exit.**

Printer 1.Emulation



We recommend that you set the emulation setting with your application software or network server. If the setting does not work properly, select the required emulation mode manually using the MFC panel buttons.

Printing the Internal Font List

You can print a list of the MFC's internal (or resident) fonts to see how each font looks before you select it.

- 1 Press **Menu, 4, 2, 1**.
- 2 Press **Start**. The MFC prints the list.
- 3 Press **Stop/Exit**.

```
Print Options
1.Internal Font
```

Printing the Print Configuration List

You can print a list of current printer settings.

- 1 Press **Menu, 4, 2, 2**.
- 2 Press **Start**. The MFC prints the settings.
- 3 Press **Stop/Exit**.

```
Print Options
2.Configuration
```

Restoring default settings

You can return the MFC to the default settings. Fonts and macros in the temporary settings are cleared.

- 1 Press **Menu, 4, 3**.
- 2 Press **1** to restore the default settings

```
Printer
3.Reset Printer
```

—OR—

Press **2** to exit without making a change.

- 3 Press **Stop/Exit**.



Only the printer settings will be returned to the default settings.

2

Printer driver settings

(Windows® Only)

Printer driver settings

You can change the following printer settings when you print from your computer:

- **Media Type**
- **Multiple Page**
- **Watermark***1*2
- **Scaling***2
- **Print Date & Time***1*2
- **Quick Print Setup***1*2
- **Secure Print***1

*1 These settings are not available with the BR-script (PostScript® 3™ language emulation) driver.

*2 These settings are not available with the Universal printer driver.

How to access the printer driver settings

- 1 Select **Print** from the **File** menu in your application software.
- 2 Select **Brother MFC-8220 (USB) Printer** or **Brother MFC-8220** as your printer and click **Preferences** for Windows® XP (**Properties** for Windows® 95/98/98SE/Me and 2000, **Document Defaults** for Windows NT® 4.0). The **Printing Preferences** dialog box will appear.



The way you access the printer driver settings depends on your operating system and software applications.



The screens shown in this section are from Windows® XP. The screens on your computer may vary depending on your Windows® operating system.

Features in the Brother Native Driver

The Brother Native driver is a printer driver developed exclusively by Brother. This driver includes more features than the Microsoft® Windows® Universal printer driver.

Basic tab

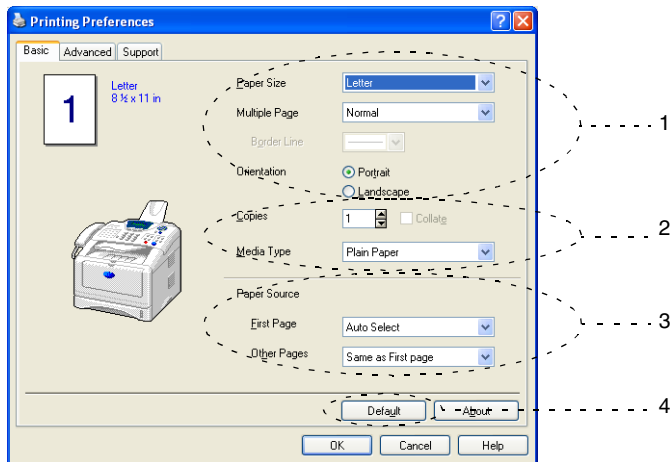

- 1 Select the **Paper Size**, **Multiple Page**, **Border Line** (if any) and **Orientation**.
- 2 Select number of **Copies** and **Media Type**.
- 3 Select **Paper Source** (**First Page** and **Other Pages**).
Auto Select allows the printer driver to select a suitable tray for **Paper Size** automatically.
You can set the paper size for each tray in the Accessories tab. (See *Accessories tab* on page 2-17.)
- 4 To return to the default settings, click the **Default** button.

Paper Size

From the drop-down box select the Paper Size you are using.

Multiple Page

The Multiple Page selection can reduce the image size of a page allowing multiple pages to be printed on one sheet of paper or enlarging the image size for printing one page on multiple sheets of paper.

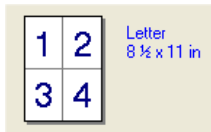

Ex. 4 in 1



Ex. 1 in 2 x 2 pages

Border Line

When printing multiple pages on one sheet with the Multiple Page feature you can select to have a solid border, dash border or no border around each page on the sheet.

Orientation

Orientation selects the position of how your original document will be printed (**Portrait** or **Landscape**).

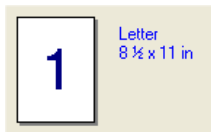

Portrait



Landscape

Copies

The copies selection sets the number of copies that will be printed.

Collate

With the **Collate** check box selected, one complete copy of your original document will be printed and then repeated for the number of copies you selected. If the **Collate** check box is not selected, then each page will be printed for all the copies selected before the next page of the original document is printed.

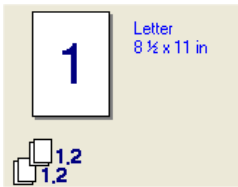

Collate box checked

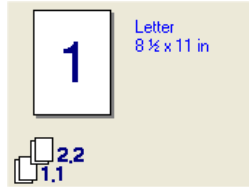

Collate box not checked

Media Type

You can use the following types of media in your MFC. For the best print quality, select the type of media that you wish to use.

Plain Paper

Thin Paper

Thick Paper

Thicker Paper

Bond Paper

Transparencies

Envelopes

Env. Thick

Env. Thin



- When using ordinary plain paper (19 to 25 lb), select **Plain Paper**. When using heavier weight paper, envelopes or rough paper select **Thick Paper** or **Thicker Paper**. For bond paper, select **Bond Paper** for OHP transparencies, select **Transparencies**.
- When you use envelopes, select **Envelopes**. If the toner is not fixed to the envelope correctly when **Envelopes** has been selected, select **Env. Thick**. If the envelope is crumpled when **Envelopes** has been selected, select **Env. Thin**.

Advanced tab

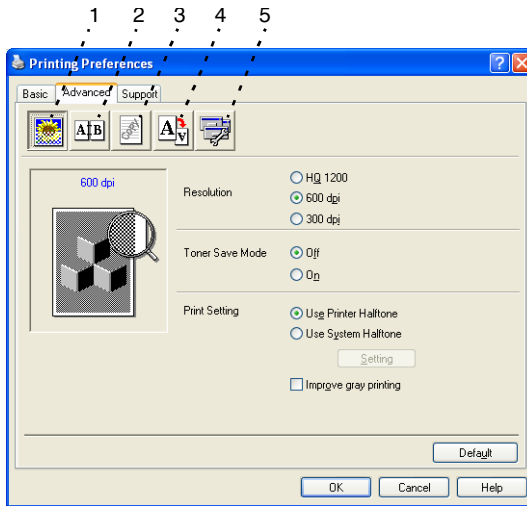

To return to the default settings, click the **Default** button.

Change the tab settings by selecting one of the following icons:

- 1 **Print Quality**
- 2 **Duplex**
- 3 **Watermark**
- 4 **Page Setting**
- 5 **Device Options**

Print Quality

Choosing the **Print Quality** icon displays the Print Quality features available.

Resolution

You can change the resolution as follows:

- HQ 1200
- 600 dpi
- 300 dpi

Toner Save

You can save running costs by turning on the Toner Save Mode, which reduces the print density.

Print Setting

For Windows® 95/98/98SE/Me

Print Setting is used for optimizing your print quality for the type of original document being printed (Photos, Graphics or Scanned Images). When you choose **Auto (Recommended)**, the printer automatically prints with the most suitable print settings.

With the Print Setting set to Manual, you can change the Brightness, Contrast and Graphics Quality options manually.

For Windows® 2000/XP/NT® WS 4.0

- Check **Use Printer Halftone** to print using Halftone.
- Check **Use System Halftone** to print using Halftone of the system. To change the setting, press **Setting**.
- If the halftone cannot be printed correctly, check **Improve gray printing**.

Duplex

Duplex printing lets the print job be printed on both sides of the paper which reduces the amount paper used for printing. Choosing the **Duplex** icon displays the Duplex features available.

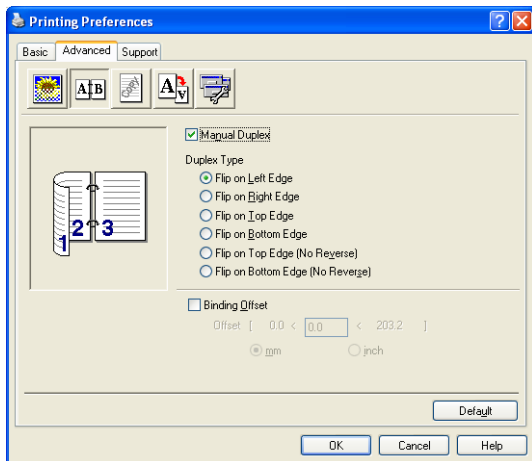

Manual Duplex

Check the **Manual Duplex** box. In this mode, the MFC prints all the even numbered pages first. Then the printer driver stops and shows the instructions required to re-install the paper. When you click OK the odd numbered pages are printed.

Duplex Type

You can select **Duplex Type**. There are six types of duplex directions available for each orientation.

Flip on Left Edge 

Flip on Right Edge 

Flip on Top Edge 

Flip on Bottom Edge 

Flip on Top Edge (No Reverse) 

Flip on Bottom Edge (No Reverse) 

Binding Offset

Check the Binding Offset option, you can specify the offset value of the binding side in inches or millimeters (0 - 8 inches) [0 - 203.2 mm].

Watermark

Choosing the **Watermark** icon displays the Watermark features available.

You can place a logo or text into your original document as a Watermark. You can select one of the preset Watermarks, or you can use a bitmap file or text file that you have created.

Check **Use Watermark**, and then select the watermark you want to use.

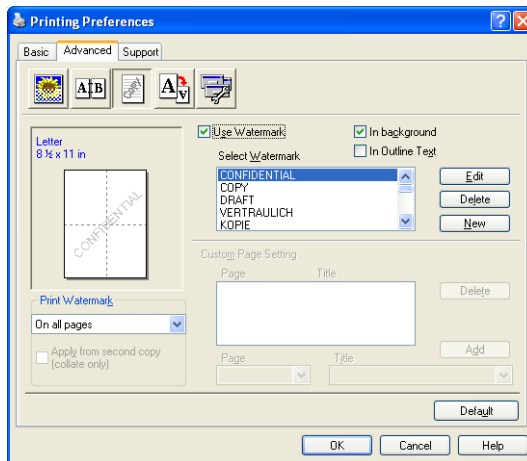

In background

Check **In background** to print the watermark image in the background of your original document. If this feature is not checked then the Watermark will be printed on top of your original document.

In Outline Text

(Windows® 2000 Professional/XP/NT® WS 4.0 Only)

Check **In Outline Text** if you only want to print an outline of the watermark.

Print Watermark

The **Print Watermark** feature offers the following print choices:

- **On all pages**
- **On first page only**
- **From second page**
- **Custom**
- **Apply from second copy (collate only)**

(For Windows® 2000 Professional/XP/ Windows NT® 4.0)

Watermark Setting

You can change the Watermark's size and position on the page by selecting the Watermark, and clicking the **Edit** button. If you want to add a new Watermark, click the **New** button, and then select **Text** or **Bitmap** in the **Watermark Style**.

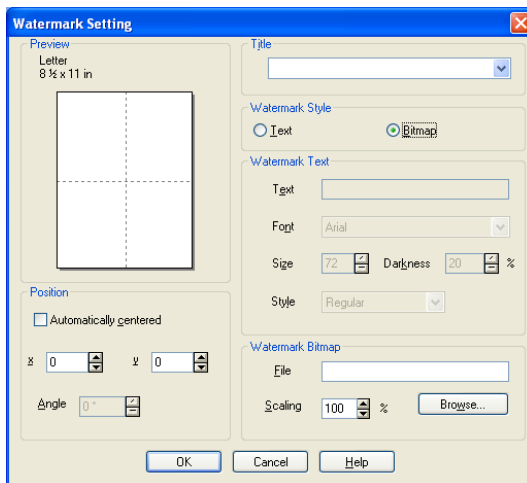

■ Title

You can select **CONFIDENTIAL**, **COPY** or **DRAFT** as the standard title or enter a title you like in the field.

■ Watermark Text

Enter your Watermark text into the **Text** Box, and then select the **Font, Size, Darkness** and **Style**.

■ Watermark Bitmap

Enter the file name and location of your bitmap image in the **File** box, or **Browse** for the file location. You can also set the scaling size of the image.

■ Position

This setting offers you the control for where the Watermark is to be positioned on the page.

Page Setting

Choosing the **Page Setting** icon displays the Page Setting features available.

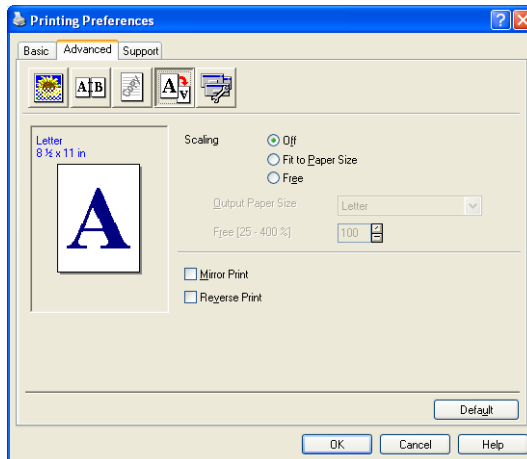

Scaling

You can change the print size of your original document with the Scaling feature.

■ Off

Print the original document as it appears on your screen.

■ Fit to Paper Size

Check here, if your original document has an unusual size, or if you have only the standard size paper.

■ Free

You can manually reduce or enlarge the output.

Mirror Print

Reverses the data left to right and prints.

Reverse Print

Rotates the data by 180 degrees and prints.

Device Options

Lets you set the following Printer Functions:

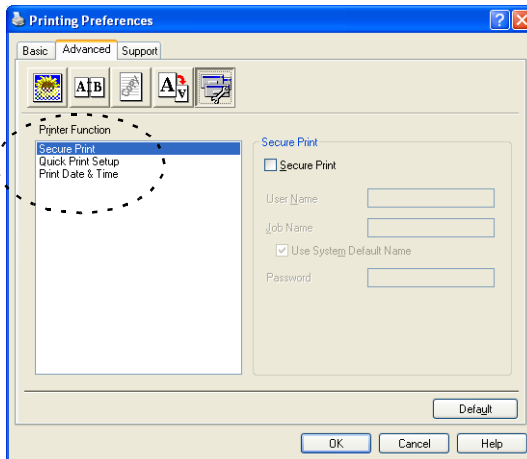

Secure Print

Secured original documents are original documents that are password protected when they are sent to the MFC. Only the people who know the password will be able to print them. Since the original documents are secured at the MFC, you must use the control panel of the MFC (with the password) to print them.

To send a secured original document:

- 1** Select **Secure Print** from **Printer Function** and check **Secure Print**.
- 2** Enter your password, user name and job name and click OK.
- 3** You must print the secured original documents from the control panel of the MFC. (See *Secure key* on page 1-10.)

To delete a secure original document:

You need to use the control panel of the MFC to delete secured original documents. (See *Secure key* on page 1-10.)



You can store up to 8 MB of secured data in the MFC's memory.

Quick Print Setup

The **Quick Print Setup** feature allows you to quickly select driver settings. To view settings, simply click your mouse button on the task tray  icon. This feature can be set to ON or OFF from the Device Options section.



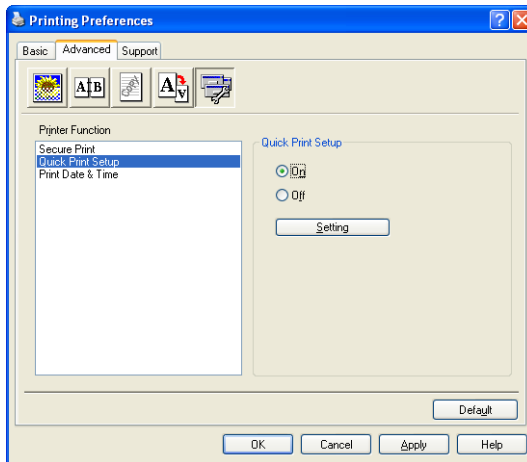

The default setting is OFF.

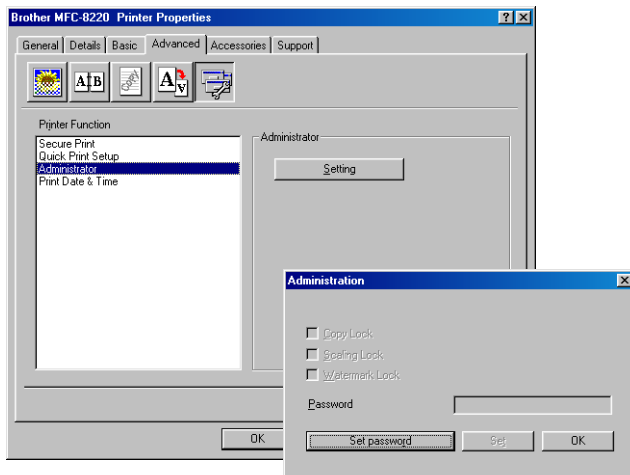

Administrator (For Windows® 95/98/98SE/Me Users Only)

The administrator selection permits the Copy, Scaling and Watermark features to be locked and password protected.



 Record your password and keep it in a safe place for future reference. If you forget your password these settings can not be accessed.

Print Date & Time

When enabled the **Print Date & Time** feature will automatically print the date and time from your computers system clock on your original documents.

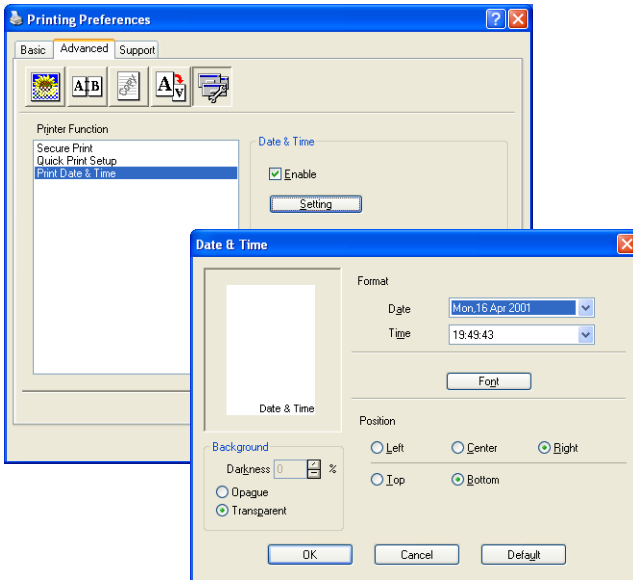

Click the **Setting** button to change the **Date** and **Time** Format. You can change the Font by clicking the **Font** button or the **Position**. To include a background with the **Date** and **Time** select **Opaque**. When **Opaque** is selected you can set the **Darkness** of the **Date** and **Time** background by changing the percentage.



The Date and Time indicated in the selection box represents the format that will be printed. The actual Date and Time printed on your original documents is automatically retrieved from the settings of your computer.

Accessories tab

The **Accessories** tab includes the settings for configuring the printer driver for the size of paper loaded in each paper source. This tab also installs any additional options into the driver settings.

Paper Source Setting

To configure the paper size for each paper source, highlight the source in the **Paper Source Setting** list. Select the **Paper Size** from the pull-down box and click **Update**. When Auto Select (default Paper Source) is set in the Basic tab of the printer driver (See *Basic tab* on page 2-2), the printer driver will automatically use the **Paper Source setting** to select a tray which matches the **Paper Size** setting in the printer driver.

Default Source

The **Default Source** allows you to choose the paper source that will be used when the paper size of the original documents being sent does not match the Paper Source settings.

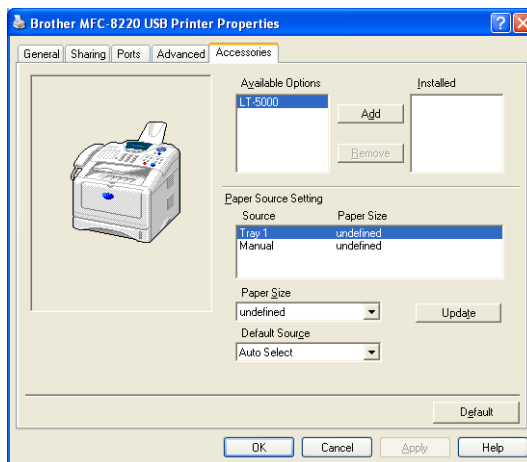

Available Options

In order to access the optional lower tray the option must be installed in the driver. Highlight the model number from the **Available Options** list and click **Add**. The optional tray will then be listed in the **Installed** box, **Paper Source Setting** list and the screen illustration will display the optional lower tray.

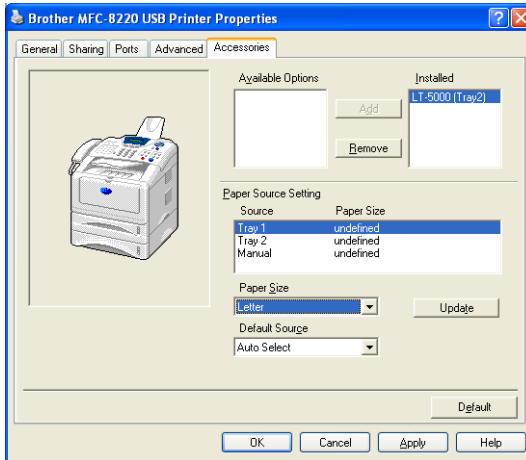

Support tab

The **Support** tab provides driver version and setting information. In addition there are links to the **Brother Solutions Center** and the Driver Update Web sites.

Click the **Support** tab to display the following screen:

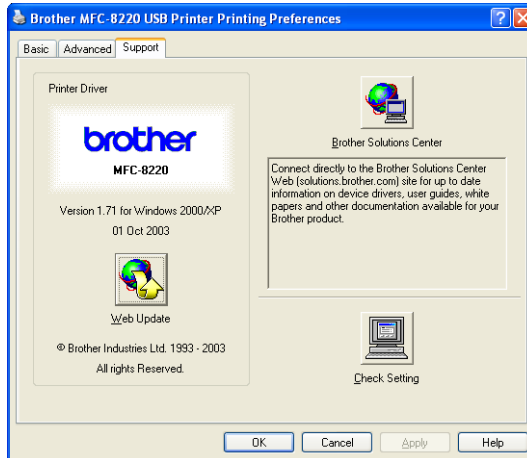

Brother Solutions Center

The **Brother Solutions Center** is a Web site offering information about your Brother product including FAQs (Frequently Asked Questions), User's Guides, Driver Updates and Tips for using your MFC.

Web Update

Web Update checks the Brother web site for updated drivers, and automatically downloads and updates the printer driver on your computer.

Check Setting

The **Check Setting** selection displays a list of your current driver settings.

Features in the PS Brother (PostScript®) printer driver (For Windows®)

The Windows® 95/98/98SE/Me/2000 Professional/XP and Windows NT® 4.0 utilizes BR-Script (PostScript® 3™ language emulation) driver.

You can download the latest driver by accessing the Brother Solutions Center at <http://solutions.brother.com>

To install the PS driver

If you have already installed the printer driver following the instruction in the Quick Setup Guide, insert the CD-ROM into the CD-ROM drive on your PC and click **Install Software**. Choose **MFL-Pro Suite** and follow the on-screen instructions. When the **Select Components** screen appears, check **PS Printer Driver**, and then continue following the on-screen instructions.

If you have not previously installed the driver and software, insert the CD-ROM into the CD-ROM drive on your PC and click **Install Software**. Choose **MFL-Pro Suite** and follow the on-screen instructions. When the **Setup Type** screen appears, select **Custom** and check the **PS Printer Driver**. Then continue following on-screen instructions.



The screens in this section are from Windows® XP.

The screens on your PC will vary depending on your operating system.

Ports tab

Select the port where your printer is connected or the path to the network printer you are using.

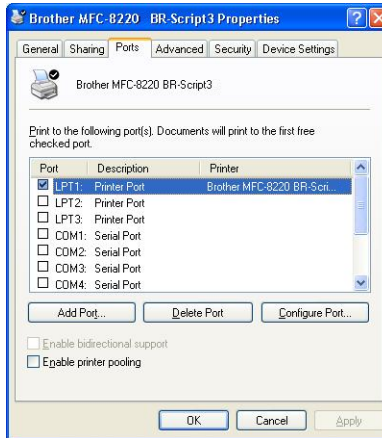

Device Settings tab

Select the options you installed to configure any additional accessories you have installed.

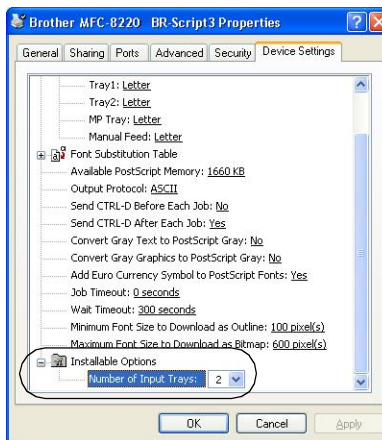

Layout tab



If you are using Windows NT[®] 4.0, Windows[®] 2000 or XP, you can access the **Layout** tab by clicking **Printing Preferences** in the **General** tab of the **Brother MFC-8220 BR-Script3 Properties** screen.

The **Layout** tab enables you to change various layout settings such as **Orientation**, **Page Order** and **Page Per Sheet**.

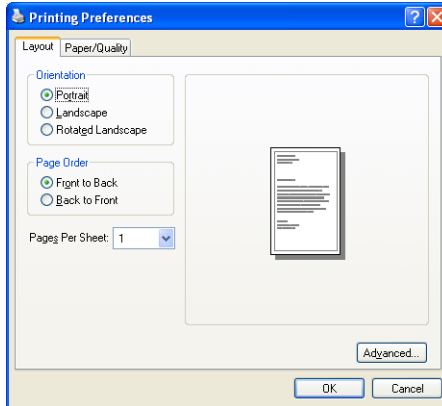

Paper / Quality tab



If you are using Windows NT[®] 4.0, Windows[®] 2000 or XP, you can access the **Paper/Quality** tab by clicking **Printing Preferences** in the **General** tab of the **Brother MFC-8220 BR-Script3 Properties** screen.

Select the **Paper Source**.

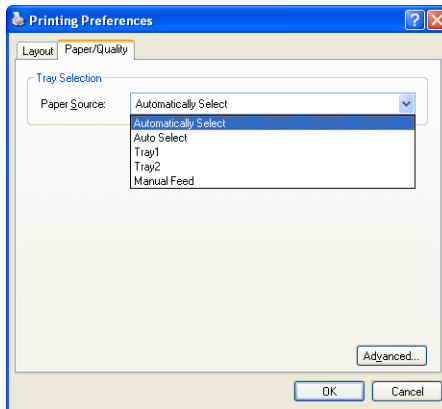

Advanced Options



If you are using Windows NT[®] 4.0, Windows[®] 2000 or XP, you can access the **Brother MFC-8220 BR-Script3 Advanced Options** tab by clicking the **Advanced** button in the **Layout** tab or the **Paper/Quality** tab.

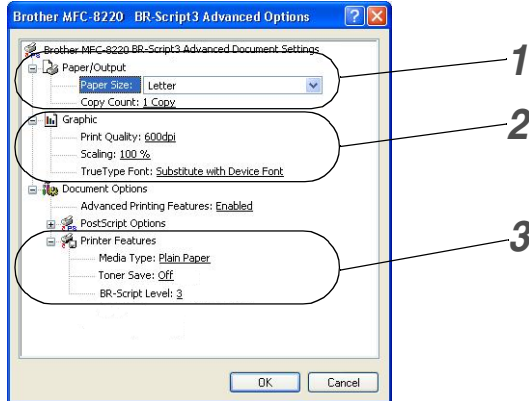

- 1** Select the **Paper Size** and **Copy Count**.
- 2** Set the **Print Quality**, **Scaling** and **TrueType Font** setting.
- 3** You can change settings by selecting the setting in the Printer Features list:
 - Media Type
 - Toner Save
 - BR-Script Level

3

How to scan using Windows®



The scanning operations and drivers will be different depending on your operating system.

For Windows® 95/98/98SE/Me/2000 Professional and Windows NT® Workstation 4.0

The MFC uses a TWAIN Compliant driver for scanning original documents from your applications. (See *Scanning an original document* on page 3-1.)

For Windows® XP

The MFC uses Windows® Imaging Acquisition (WIA) for scanning original documents. (See *Scanning an original document (For Windows® XP only)* on page 3-10.)



For ScanSoft®, PaperPort® and TextBridge® OCR

Go to *Using ScanSoft® PaperPort® and TextBridge® OCR* on page 3-17.

Scanning an original document

TWAIN compliant

The Brother MFL-Pro Suite software includes a TWAIN compliant scanner driver. TWAIN drivers meet the standard universal protocol for communicating between scanners and software applications. This means that not only can you scan images directly into the PaperPort® viewer that Brother included with your MFC, but you can also scan images directly into hundreds of other software applications that support TWAIN scanning. These applications include popular programs like Adobe® Photoshop®, Adobe® PageMaker®, CorelDraw® and many more.

How to access the Scanner

1 Open the software application (ScanSoft® PaperPort®) to scan an original document.

 The instructions for scanning in this guide are for when you use ScanSoft® PaperPort® 8.0SE.

2 Select **Scan** from the **File** drop-down menu or select the **Scan** button. The **Scan** panel appears in the left panel.

3 Select **Brother MFC-8220**, **Brother MFC-8220 USB** or **Brother MFC-8220 LAN** (if the optional NC-9100h is installed) from the **Scanner** drop-down list box.

4 Click **Scan**.

 If the MFC is connected via:

Parallel - use **Brother MFC-8220**

USB - use **Brother MFC-8220 USB**

LAN - use **Brother MFC-8220 LAN** (if the optional NC-9100h is installed)

The **Brother MFC-8220**, **Brother MFC-8220 USB** or **Brother MFC-8220 LAN Scanner Setup** dialog box will appear:

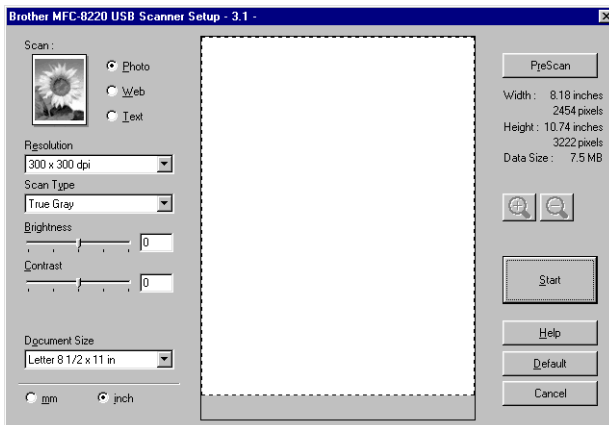

Scanning an original document into the PC

You can scan a whole page

—OR—

Scan a portion of the page after pre-scanning the original document.

Scanning a whole page

- 1 Place the original document face down in the ADF.
- 2 Adjust the following settings, if required, in the Scanner window:
 - **Image Type**
 - **Resolution**
 - **Scan Type**
 - **Brightness**
 - **Contrast**
 - **Document Size**



After you select a document size, you can adjust the scanning area further by clicking the left mouse button and dragging it. This is required when you want to crop an image when scanning. (See *Settings in the Scanner window* on page 3-6.)

- 3 Click the **Start** button in the scanner window.

When scanning is completed, click **Cancel** to return to the PaperPort® window.

Pre-Scanning to crop a portion you want to scan

The **PreScan** button is used to preview an image for cropping any unwanted areas from the image. When you are satisfied with the preview, click the **Start** button in the scanner window to scan the image.

- 1 Place the original document face down in the ADF.

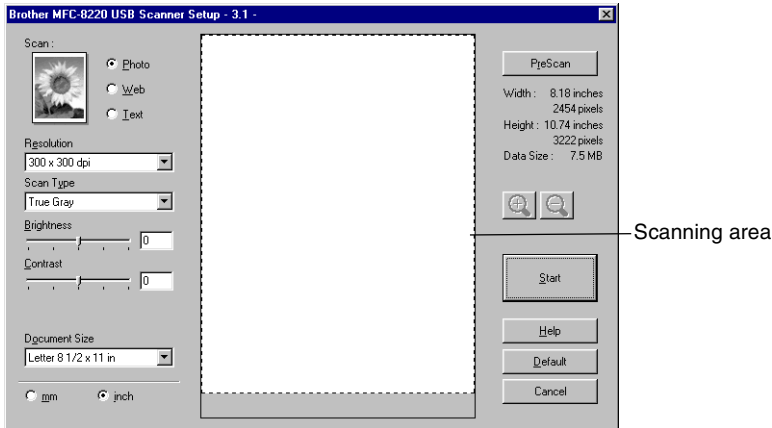

- 2 Select the settings for **Image Type**, **Resolution**, **Scan Type**, **Brightness** and **Contrast**, as needed.

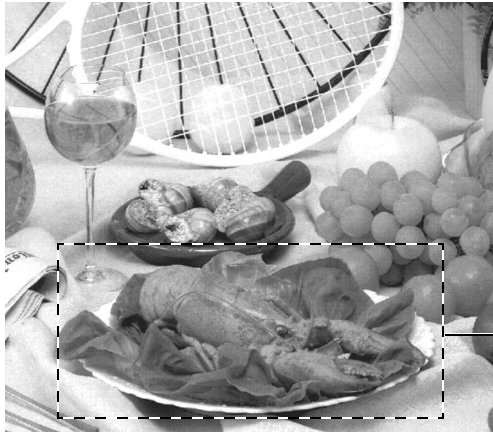

- 3** In the **Brother MFC-8220, Brother MFC-8220 USB** or **Brother MFC-8220 LAN Scanner Setup** dialog box, click the **PreScan** button.

The entire original document will be scanned into the PC and will appear in the Scanning Area.



Scanning area

- 4** Select the portion you want to scan by clicking the left mouse button and dragging it.

 You can enlarge the portion you selected by pressing  to check it. If you want to select a different portion, use  to undo the image.

- 5** Place the original document face down in the ADF again.

- 6** Click **Start**.

This time only the selected area of the original document will appear in the PaperPort[®] window (or your software application window).

- 7** In the PaperPort[®] window, use the options available to refine the image.

Settings in the Scanner window

Image Type

Select the image type of output from **Photo**, **Web** or **Text**.

Resolution and **Scan Type** will be altered for each default setting.

The default settings are:

Image Type		Resolution	Scan Type
Photo	Select for scanning photo images.	300 x 300 dpi	True Gray
Web	Select for attaching the scanned image to web pages.	100 x 100 dpi	True Gray
Text	Select for scanning text original documents.	200 x 200 dpi	Black & White

Resolution

You can change the scanning resolution from the **Resolution** drop down list. Higher resolutions take more memory and transfer time, but can achieve a finer scanned image. You can choose Black & White/Gray (Error Diffusion) and True Gray. The following shows the resolution you can choose.

- 100 × 100 dpi
- 150 × 150 dpi
- 200 × 200 dpi
- 300 × 300 dpi
- 400 × 400 dpi
- 600 × 600 dpi
- 1200 × 1200 dpi
- 2400 × 2400 dpi
- 4800 × 4800 dpi
- 9600 × 9600 dpi

Scan Type

Black & White: Set the Scan Type to **Black & White** for text or line art.

Gray Scale: Set the Scan Type to Gray or True Gray for photographic images.

Brightness

Adjust the settings (-50 to 50) to obtain the best image. The default value is 0, representing an 'average'.

You can set the level by dragging the slide bar to the right or left to lighten or darken the image. You can also type a value in the box for the setting.

If the scanned image is too light, set a lower brightness value and scan the original document again. If the image is too dark, set a higher brightness value and scan the original document again.

Contrast

This setting is adjustable only when you have selected one of the gray scale settings. It is not available when **Black & White** settings are selected as the **Scan Type**.

You can increase or decrease the contrast level by moving the slide bar to the left or right. An increase emphasizes dark and light areas of the image, while a decrease reveals more detail in gray areas. You can also type a value in the box for the setting.

Document Size

Set the Size to one of the following:

- Letter (8 1/2 × 11 in.)
- A4 (210 × 297 mm)
- Legal (8 1/2 × 14 in.)
- A5 (148 × 210 mm)
- B5 (182 × 257 mm)
- Executive (7 1/4 × 10 1/2 in.)
- Photo 3.5 × 5 in. (9 × 13 cm)
- Photo 5 × 7 in. (13 × 18 cm)
- APS C 4 × 6 in. (10 × 15 cm)
- Business Card (60 × 90 mm)
- Custom (User adjustable from 0.35 × 0.35 in. to 8.5 × 14 in. or 8.9 × 8.9 mm to 215.9 × 355.6 mm)

When scanning photographs or other images for use in a word processor or other graphics application. You should try different settings for the contrast and resolution modes to see which best suits your needs.

If you selected **Custom** as the size, the **Custom Document Size** dialog box will appear.

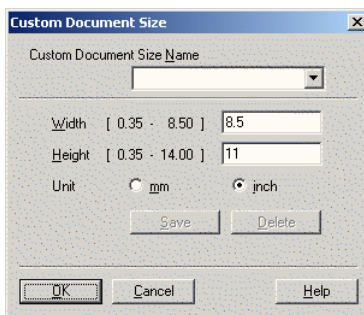

Type the **Name**, **Width** and **Height** for the original document. You can choose “mm” or “inch” as the unit for Width and Height.



You can see the actual paper size you selected on the screen.

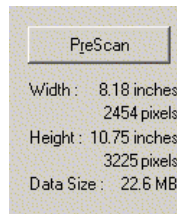

- **Width:** shows the width of scanning area
- **Height:** shows the height of scanning area
- **Data Size:** shows the approximate data size calculated in a Bitmap format. The size will be different for other file formats such as JPEG.

Scanning an original document (For Windows® XP only)

WIA compliant

Windows® XP uses Windows Image Acquisition (WIA) for scanning images from the MFC. You can scan images directly into the PaperPort® viewer that Brother included with your MFC or you can scan images directly into any other software application that supports WIA or TWAIN scanning.

How to access the scanner

1 Open your software application to scan an original document.



The instructions for scanning in this guide are for when you use ScanSoft® PaperPort® 8.0. The steps for scanning from another application may vary.

2 Select **Scan** from the **File** drop-down menu or select the Scan button.

The **Scan** panel appears in the left panel.

3 Select the scanner you are using from the **Scanner** drop-down list box.

4 Click **Scan**.

The Scan dialog box will appear:

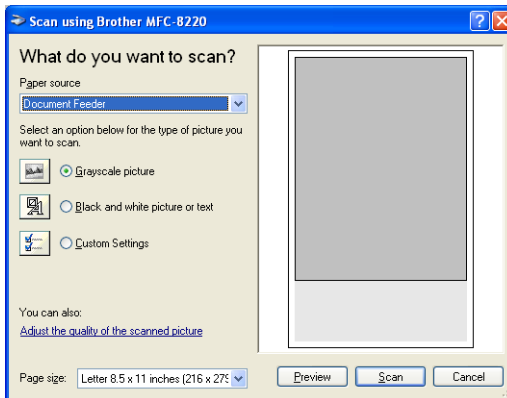

Scanning an original document into the PC

- 1 Place the original document face down in the ADF.

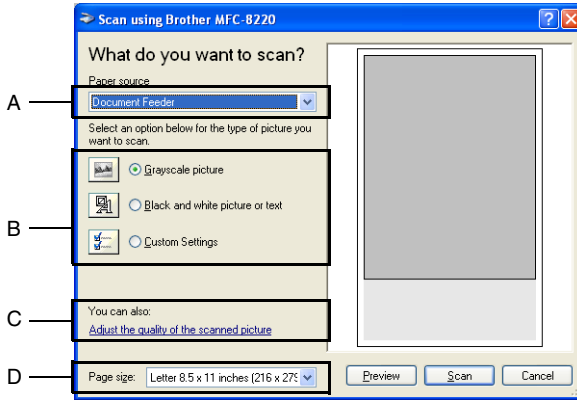

- 2 Select the **Document Feeder** from the **Paper source** drop-down list box (A).
- 3 Select the picture type (B).
- 4 Select the **Paper size** from the drop-down list box (D).

- 5 If you require advanced settings, click **Adjust the quality of the scanned picture (C)**. You can select **Brightness**, **Contrast**, **Resolution** and **Picture Type** from the **Advanced Properties**. Click the **OK** button after you choose your settings.

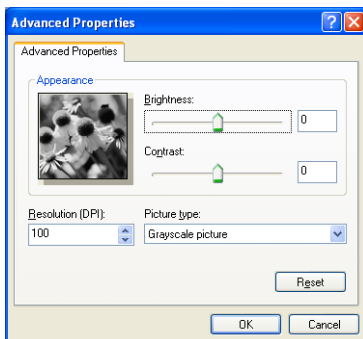

- The scanner resolution you can select is up to 1200 × 1200 dpi.
 - For resolutions greater than 1200 dpi, use the Brother Scanner Utility. (See *Brother Scanner Utility* on page 3-13.)
- 6 To start scanning your original document, click the **Scan** button in the Scan dialog box.

Brother Scanner Utility

The Brother Scanner Utility is used for configuring the scanner driver for resolutions greater than 1200 dpi. You must restart your PC for the new settings to take effect.

To run the utility:

You can run the utility by selecting the **Scanner Utility** located in the **Start/All Programs/Brother/MFL-Pro Suite MFC-8220** menu.

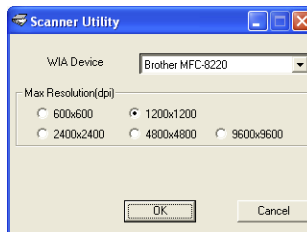

Scanning at resolutions greater than 1200 dpi may cause problems with some scanning applications.

Using the Scan key (For USB or Parallel interface cable users)

You can use  (**Scan**) on the control panel to scan original documents into your word processing, graphics or E-mail applications or your computer folder. The advantage of using

 (**Scan**) is that you avoid the mouse clicks required to scan from your computer.





Scan



For Scan to E-mail, Scan to Image, Scan to OCR and Scan to File

Before you can use  (**Scan**) on the control panel, you must have connected the MFC to your Windows® based computer and loaded the appropriate Brother Drivers for your version of Windows®.

When you are ready to use  (**Scan**), make sure the Brother Control Center application is running on your computer. For details about how to configure the Brother Control Center buttons to launch the application of your choice using

 (**Scan**), go to the appropriate chapter:

- For Windows® 95/98/98SE/Me/2000 Professional and Windows NT® WS 4.0, see *Using the Brother Control Center* on page 4-1.
- For Windows® XP, see *Using the Windows®-Based Brother Control Center* on page 5-1.
- If your MFC is connected with both a USB and a Parallel cable, you need to select USB or Parallel as the destination in each step.



Scan to E-mail

You can scan a black and white original document into your E-mail application as a file attachment. You can also change the  (**Scan**) configuration. (See *Scan to E-mail* on page 4-10 to 4-12.) (For Windows® XP: See *Hardware Section: Changing the Scan to button configuration* on page 5-5 to 5-11.)

1 Place the original document face down in the ADF.

2 Press  (**Scan**).

Select ▲▼ & Set
Scan to E-mail ◆

3 Press  or  to select Scan to E-Mail.
Press **Set**.

The MFC will scan the original document, create a file attachment, and launch your E-mail application, displaying the new message waiting to be addressed.



Scan to Image

You can scan a picture into your graphics application for viewing and editing. You can also change the  (**Scan**) configuration. (See *Scan to Image* on page 4-16.) (For Windows® XP: See *Hardware Section: Changing the Scan to button configuration* on page 5-5 to 5-11.)

1 Place the original document face down in the ADF.

2 Press  (**Scan**).

Select ▲▼ & Set
Scan to Image ◆

3 Press  or  to select Scan to Image.
Press **Set**.

The MFC will start the scanning process.



Scan to OCR

If your original document is text, you can have it converted by ScanSoft® TextBridge® to an editable text file and then have the result displayed in your word processing application for viewing and editing. You can change the  (**Scan**) configuration. (See *Scan to OCR (Word Processor)* on page 4-13 to 4-15.) (For Windows® XP: See *Hardware Section: Changing the Scan to button configuration* on page 5-5 to 5-11.)

1 Place the original document face down in the ADF.

2 Press  (**Scan**).

Select ▲▼ & Set
Scan to OCR ⚙

3 Press  or  to select Scan to OCR.
Press **Set**.

The MFC will start the scanning process.



Scan to File

You can scan a black and white original document into your computer and save it as a file in the folder you choose. The file type and specific folder are based on the settings you have chosen in the Scan to File screen of the Brother MFL-Pro Control Center. (See *Scan to File* on page 4-8 to 4-9.) (For Windows® XP: See *Hardware Section: Changing the Scan to button configuration* on page 5-5 to 5-11.)

1 Place the original document face down in the ADF.

2 Press  (**Scan**).

Select ▲▼ & Set
Scan to File ⚙

3 Press  or  to select Scan to File.
Press **Set**.

The MFC will start the scanning process.

Using ScanSoft® PaperPort® and TextBridge® OCR

ScanSoft® PaperPort® for Brother is a document management application. You will use PaperPort® to view scanned original documents.

PaperPort® has a sophisticated, yet easy-to-use, filing system that will help you organize your graphics and text original documents. It allows you to combine or “stack” original documents of different formats for printing, faxing or filing.

ScanSoft® PaperPort® can be accessed through the ScanSoft® PaperPort® program group.

See *Documentation for ScanSoft® PaperPort® on the CD-ROM.*

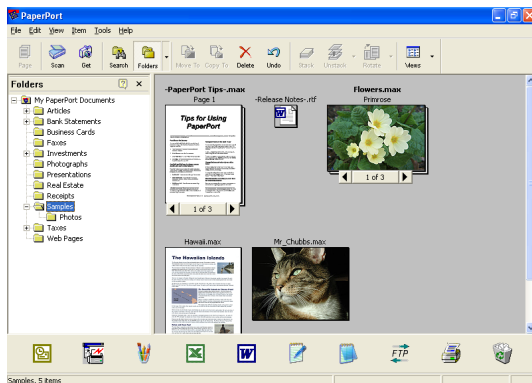

The complete ScanSoft® PaperPort® User’s Guide, including ScanSoft® TextBridge® OCR, is in the documentation on the CD-ROM.

This chapter is only an introduction to the basic operations.

When you install MFL-Pro Suite, ScanSoft® PaperPort® for Brother and ScanSoft® TextBridge® OCR are installed with it automatically.



If you are using Windows® XP, Windows NT® 4.0 or Windows® 2000 Professional, we recommend that you are logged on with administrator rights.

Viewing items

ScanSoft® PaperPort® provides several ways to view items:

Desktop View displays a thumbnail (a small graphic that represents each item in a Desktop or folder).

Items in the selected folder appear on the PaperPort® Desktop. You can see PaperPort® items (MAX files) and non-PaperPort® items (files created using other applications).

Non-PaperPort® items include an icon that indicates the application that was used to create the item; a non-PaperPort® item is represented by a small rectangular thumbnail and not an actual image.

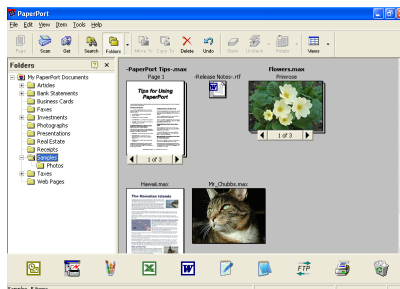

Desktop View displays items as thumbnails

Page View displays a close-up of a single page and you can open a PaperPort® item by double-clicking on it.

As long as you have the appropriate application on your computer to display it, you can also double-click a non-PaperPort® item to open it.

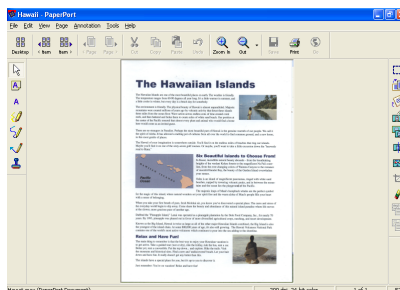

Page View displays each item as a full page

Organizing your items in folders

PaperPort® has an easy-to-use filing system for organizing your items. The filing system consists of folders and items that you select to view in Desktop View. An item can be a PaperPort® item or a non-PaperPort® item:

- Folders are arranged in a “tree” structure in the Folder View. You use this section to select folders and view their items in Desktop View.
- You can simply drag and drop an item onto a folder. When the folder is highlighted, release the mouse button and the item is stored in that folder.
- Folders can be “nested”—that is, stored in other folders.
- When you double-click a folder, its items (both PaperPort® MAX files and non paperport® files) appear on the Desktop.
- **You can also use Windows® Explorer to manage the folders and items shown in Desktop View.**

Quick links to other applications

ScanSoft® PaperPort® automatically recognizes many other applications on your computer and creates a “working link” to them. The Send To Bar at the bottom of the Desktop view shows icons of those linked applications.

To use a link, drag an item onto one of the icons to start the application represented by the icon. A typical use of the Send To Bar is to select an item and then fax it.

This sample Send To Bar shows several applications with links to PaperPort®.



If PaperPort® does not automatically recognize one of the applications on your computer, you can manually create a link using the **Add to Send To Bar...** command.

(See PaperPort® in the Documentation section on the CD-ROM for more information about creating new links.)

ScanSoft® TextBridge® OCR lets you convert image text into text you can edit

Software by:



ScanSoft® TextBridge® OCR is installed automatically with PaperPort® when you install MFL-Pro Suite on your computer.

ScanSoft® PaperPort® can quickly convert the text on a ScanSoft® PaperPort® item (which is really just a picture of the text) into text that you can edit with a word processing application.

PaperPort® uses the optical character recognition application ScanSoft® TextBridge®, which comes with PaperPort®

—OR—

PaperPort® can use your preferred OCR application if it is already on your computer. You can convert the entire item, or by using the **Copy Text** command, you can select only a portion of the text to convert.

Dragging an item onto a word-processing link icon starts PaperPort®'s built-in OCR application, or you can use your own OCR application.



You can Import items from other applications

In addition to scanning items, you can bring items into PaperPort® in a variety of ways and convert them to PaperPort® (MAX) files in several different ways:

- Print to the Desktop View from another application, such as Microsoft® Excel.
- Import files saved in other file formats, such as Windows® Bitmap (BMP) or Tagged Image File Format (TIFF).

You can Export items in other formats

You can export or save PaperPort® items in several popular file formats, such as BMP, JPEG, TIFF, or self-viewing.

For example, to create a file for an Internet Web site, export it as a JPEG file. Web pages often use JPEG files for displaying images.

Exporting an image file

- 1** Select the Save As command from the File pull-down menu in the PaperPort® window. The Save 'XXXXX' as dialog box will be displayed.
- 2** Select the drive and directory where you want to store the file.
- 3** Enter the new file name and choose the file type or select a name from the File Name text box. (You can scroll through the Directories and File Name listing for prompting.)
- 4** Select the **OK** button to save your file, or **Cancel** to return to the PaperPort® without saving it.

How to Uninstall PaperPort® and ScanSoft® TextBridge®

For Windows® 95/98/98SE, and Windows NT® Workstation 4.0 and Windows® Me:

Select **Start, Settings, Control Panel, Add/Remove Programs** and the **Install/Uninstall** tab.

Select **Brother Extensions for Paperport** and click the **Add/Remove** button.

Select **PaperPort® 8.0 SE** from the list and click the **Add/Remove** button.

For Windows® 2000 Professional:

Select **Start, Settings, Control Panel** and **Add/Remove Programs**.

Select **Brother Extensions for Paperport** and click the **Change/Remove** button.

Select **PaperPort® 8.0 SE** from the list and click the **Change** button.

For Windows® XP:

Select **Start, Control Panel, Add or Remove Programs** and the **Change or Remove Programs** icon.

Select **PaperPort® 8.0 SE** from the list and click the **Change** button.

4

Using the Brother Control Center

(For Windows® 95/98/98SE/Me/2000 Professional and Windows NT® WS 4.0)



If you are using Windows® 2000 Professional or Windows NT® 4.0, we recommend that you are logged on with administrator rights.

Brother MFL-Pro Control Center

The Brother Control Center is a software utility that pops up on the PC screen whenever paper is put in the ADF of the MFC. This allows you to quickly and with very few mouse clicks, to access the most frequently used scanning applications. Using the Control Center stops the need to manually startup any specific applications.

The Brother Control Center provides three operations (Scan, Copy and PC-Fax):

- Scan directly to a file, E-mail, word processor or graphic application of your choice
- Copy
- PC Faxing using the Brother PC-FAX software





AutoLoad the Brother Control Center

The Control Center is loaded every time Windows® is started.



When the Control Center is loaded, the **Control Center**  icon will appear on the task bar.

If you don't want the Control Center to load automatically, you can turn off AutoLoad.

 If the **Control Center**  icon does not appear on your task bar, you will have to launch the software.

Double-click the **Control Center**  icon on the desktop or from the **Start** menu, select **Programs**, **ScanSoft PaperPort 8.0**, and then click **Brother SmartUI POPUP**.

How to turn off AutoLoad

- 1 Left-click the **Control Center**  icon and click **Show**.
- 2 When the Control Center window appears, left click the **Smart Click**  **Control Center** button.

A dialog box will appear:

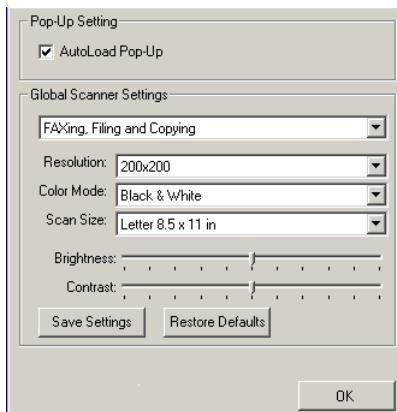

- 3 Uncheck the 'AutoLoad' Pop-Up check box.

Brother Control Center features

Auto Configuration

During installation the Control Center will check your system to set up the default applications for E-mail, word processing and the graphics viewer/editor.

For example, if you are using Outlook as your default E-mail application, the Control Center will create a link and a scanning application button for Outlook.

You can change a default application. Right-click the appropriate Control Center button to display *Configurations* and then click it. Select a different application.

For example, you can change a scan button from MS Word Pad



to MS Word



by changing the application that is listed for the Word Processor.

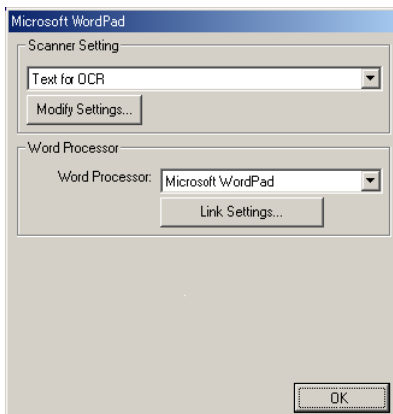

Scan key operations

Scan to File—Lets you scan directly to a file on your computer. You can change the file type and directory for the original document you are scanning.

Scan to E-mail—Lets you scan a picture or text original directly into an E-mail application as a standard attachment. You can choose the file type and resolution for the attachment.

Scan to OCR (Word Processor)—Lets you scan a text original, run ScanSoft TextBridge® OCR, and insert the text original (not a graphic image) into a word processing file. You can choose the word processing application, such as Word Pad, MS Word, and so on.

Scan to Image—Lets you scan an image directly into any graphic viewer/editor application. You can choose the graphics application, such as Microsoft Paint.

Copy operations

Copy—Lets you use the PC and any Windows® printer driver for enhanced copy operations.

You can scan the page on the Brother MFC and print the copies using any of the features of the Brother MFC printer driver.

—OR—

You can send the copy output to any standard Windows® printer driver that is on your PC.

PC-Fax operation

Send a Fax—Lets you scan a picture or text original and send the image as a fax from the PC using the Brother PC-FAX software.

Scanner settings for Scan, Copy and PC-Fax buttons

When the Pop-Up screen appears, you can access the Scanner Settings window.

Click the **Smart Click**  **Control Center** icon at the top right of the Brother Control Center screen.

—OR—

Click the **Modify Settings** button on any of the Configuration screens.

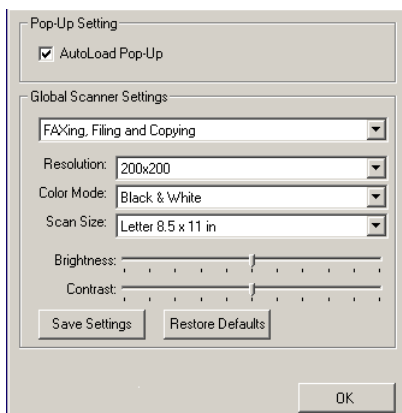

Global settings

AutoLoad Pop-Up—Select this checkbox if you want the Brother MFL Control Center to load when you turn on your computer.

Setting up the scanner configurations

The Pop-Up application stores eight different scanning modes. Each time you scan an original document, you can choose the most appropriate scanning mode from the following:

Faxing, Filing and Copying

Text for OCR

Photos

Photos (High Quality)

Photos (Quick Scan)

Custom

Draft Copy

Fine Copy

Each mode has its own set of stored settings. You can keep the default settings or change them at any time:

Resolution—From the pull-down list, select the scanning resolution you most often use.

Color Mode—From the pull-down list, select the color settings you most often use.

Scan Size—From the pull-down list, select the scan size you most often use.

Brightness—Slide the adjuster from 0% to 100%

Contrast—Slide the adjuster from 0% to 100%

Click **OK** to save your changes. If you make a mistake or want the original document default setting, just click the **Restore Defaults** button when the scanning mode is displayed.

Perform an operation from the Control Center screen

If you see this screen it means you left-clicked a button in the Control Center window without first placing an original document in the ADF.

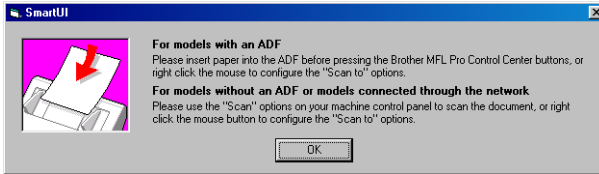

Place the original document in the MFC's ADF, and then click **OK** to go to the Control Center screen.

Scan to File

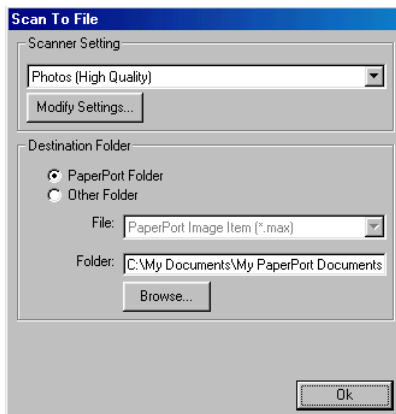

To access Scan to File Configurations screen

- 1 Place the original document face down in the ADF. The Brother Control Center screen will pop up.
- 2 Right-click Scan to File and click on *Configuration*. Click the **Modify Settings** button to view the configuration screen of the **Control Center**.
- 3 To save your settings, click **OK**.
—OR—
To go back to the default settings, click the **Restore Defaults** button.

Scanner settings

From the pull-down list, select the scanning mode that is appropriate for the type of file: **Faxing, Filing and Copying; Text for OCR; Photos; Photos (High Quality); Photos (Quick Scan); Custom; Draft Copy** or **Fine Copy**.

To change any of the settings for the mode, click **Modify Settings**.

Destination folder

PaperPort Folder—Select this checkbox to scan the original document into your PaperPort folder.

Other Folder—Select this checkbox to scan the original document as another file type or to store it in another directory/folder.

File—If you selected Other Folder from the pull-down list, select the type of file:

- PaperPort Image Item (*.max)**
- PaperPort Self-Viewing (*.exe)**
- PaperPort Browser-Viewable (*.htm)**
- PaperPort 5.0 Image Item (*.max)**
- PaperPort 4.0 Image Item (*.max)**
- PaperPort 3.0 Image Item (*.max)**
- Windows Bitmap (*.bmp)**
- PC Paintbrush (*.pcx)**
- PCX Multi-page (*.dcx)**
- JPEG (*.jpg)**
- TIFF-Uncompressed (*.tif)**
- TIFF-Group 4 (*.tif)**
- TIFF-Class F (*.tif)**
- TIFF Multi-page - Uncompressed (*.tif)**
- TIFF Multi-page - Group 4 (*.tif)**
- TIFF Multi-page - Class F (*.tif)**
- Portable Network Graphics (*.png)**
- FlashPix (*.fpx)**

To Search your system for the directory and folder you want, click the **Browse** button. Click **OK** to save your settings.

Scan to E-mail

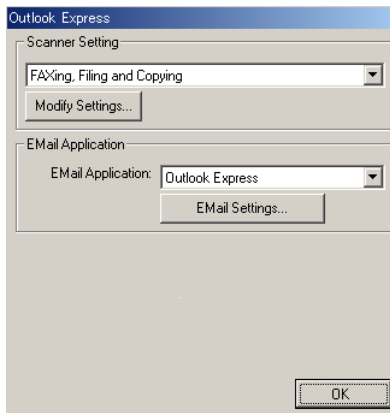

To access Scan to E-mail Configurations screen

- 1 Place the original document face down in the ADF. The Brother Control Center screen will pop up.
- 2 Right-click the E-mail application button and click on *Configuration*. Click the **Modify Settings** button to view the configuration screen of the **Control Center**.
- 3 To save your settings, click **OK**.

—OR—

To go back to the default settings, click the **Restore Defaults** button.

Scanner settings

From the pull-down list, select the scanning mode that is appropriate for the type of file: **Faxing, Filing and Copying; Text for OCR; Photos; Photos (High Quality); Photos (Quick Scan); Custom; Draft Copy** or **Fine Copy**.

To change any of the settings for this mode, click **Modify Settings**.

E-mail application

E-mail Application—From the pull-down list, select your E-mail application.

E-mail Settings—Click the **E-Mail Settings** button to set up links. The **Send To Options** window will appear:

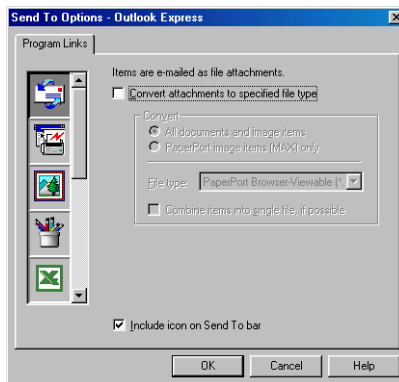

Send to Options

Convert attachments to specified file type—Converts items to the type in the **File Type** box. Clear this check box to keep files in their source format; for example, to keep Word documents in the .doc format and JPEG images in the .jpg format.

All documents and image items—Converts all items regardless of the program in which the item was created; for example, converts all Word (doc) files and JPEG (.jpg) files to the file type.

PaperPort image items (max) only—Converts only PaperPort image items (.max) files. PaperPort does not convert other file types, such as JPEG images and Word documents.

File type—Identifies the format in which to convert items; for example, JPEG or TIFF.

Combine items into single file, if possible—Combines all selected items into a single file that contains multiple pages. This option is available only when the file type supports multiple pages, such as multi-page TIFF.

Scan to OCR (Word Processor)

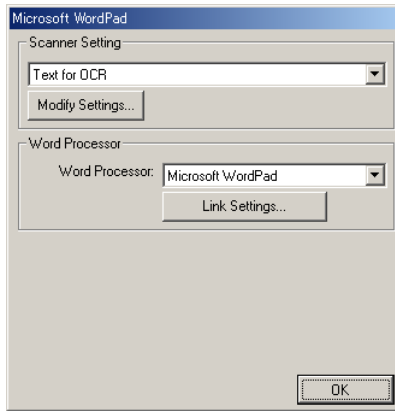

To access Scan to OCR Configurations screen

- 1 Place the original document face down in the ADF. The Brother Control Center screen will pop up.
- 2 Right-click the word processor application button and click on *Configuration*. Click the **Modify Settings** button to view the configuration screen of the **Control Center**.
- 3 To save your settings, click **OK**.

—OR—

To go back to the default settings, click the **Restore Defaults** button.

Scanner settings

From the pull-down list, select the scanning mode that is appropriate for the type of file: **Faxing, Filing and Copying; Text for OCR; Photos; Photos (High Quality); Photos (Quick Scan); Custom; Draft Copy** or **Fine Copy**.

To change any of the settings for this mode, click **Modify Settings**.

Word Processor

Word Processor—From the pull-down list, select the word processor you want to use.

Click the **Link Settings** button to display the screen to set up the original document format you want to use and identify the OCR program:

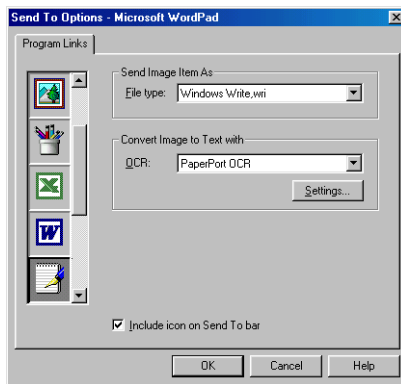

File Type—From the pull-down list, select the file type you want to use for your word processor or text original.

OCR—Identify the OCR program to use to convert scanned original document images to editable original documents. This option is available only when you have an OCR program other than the one provided with PaperPort. (PaperPort 8.0 uses the same OCR engine that is in ScanSoft's TextBridge® Pro Millennium product.)

Click the **Settings** button to choose how the OCR application will read the pages that you scan into your word processor application. The **OCR Settings** window will appear:

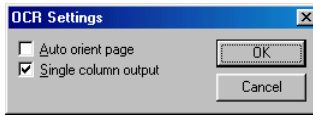

Select your setting and click **OK**.

- **Auto orient page**—Click this checkbox to automatically rotate pages so that the text is upright.
- **Single column output**—Click this checkbox if you want to remove columns from multi-column original document so that converted text appears in a one-column format.

Scan to Image

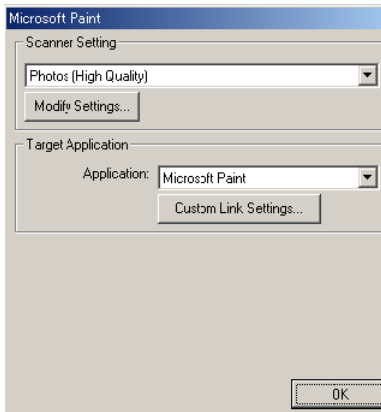

To access Scan to Image Configurations screen

- 1** Place the original document face down in the ADF. The Brother Control Center screen will pop up.
- 2** Right-click the graphic application button and click on *Configuration*. Click the **Modify Settings** button to view the configuration screen of the **Control Center**.
- 3** To save your settings, click **OK**.

—OR—

To go back to the default settings, click the **Restore Defaults** button.

Scanner Settings

From the pull-down list, select the scanning mode that is appropriate for the type of file: **Faxing, Filing and Copying; Text for OCR; Photos; Photos (High Quality); Photos (Quick Scan); Custom; Draft Copy** or **Fine Copy**.

To change any of the settings for this mode, click **Modify Settings**.

Target Application

Application—From the pull-down list, select the application you want to add to this Pop-Up screen.

Click the **Custom Link Settings** button to set up links for your user-defined application.

Copy

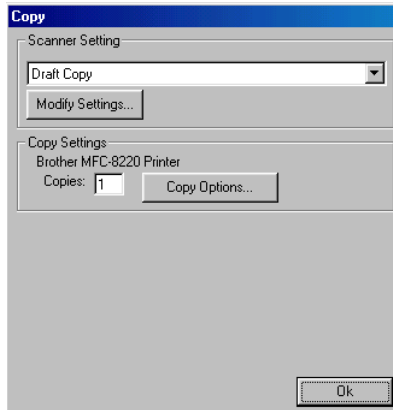

To access the Copy Configurations screen

- 1 Place the original document face down in the ADF. The Brother Control Center screen will pop up.
- 2 Right-click the Copy and click on *Configuration*. Click the **Modify Settings** button to view the configuration screen of the **Control Center**.
- 3 To save your settings, click **OK**.
—OR—
To go back to the default settings, click the **Restore Defaults** button.

Scanner settings

From the pull-down list, select the scanning mode that is appropriate for the type of file: **Draft Copy** or **Fine Copy**.

To change any of the settings for this mode, click **Modify Settings**.

Number of copies

Copies—Enter the number of copies you want to print.

To change the copy options, click the **Copy Options** button.

Click **OK** to save your Copy settings.

Send a fax

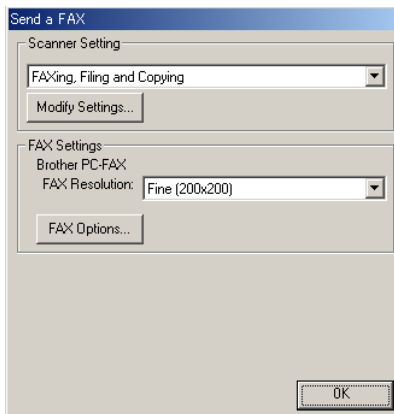

To access the Send a fax Configurations screen

- 1 Place the original document face down in the ADF. The Brother Control Center screen will pop up.
- 2 Right-click the Send a fax and click on *Configuration*. Click the **Modify Settings** button to view the configuration screen of the **Control Center**.
- 3 To save your settings, click **OK**.
—OR—
To go back to the default settings, click the **Restore Defaults** button.

Scanner settings

From the pull-down list, select the scanning mode that is appropriate for the type of file: **Faxing, Filing and Copying; Text for OCR; Photos; Photos (High Quality); Photos (Quick Scan); Custom; Draft Copy** or **Fine Copy**.

To change any of the settings for this mode, click **Modify Settings**.

PC-FAX Settings

Brother PC-Fax

FAX Resolution—Fine (200 × 200)

- 1 To change the fax options, click the **FAX Options** button. The Brother PC-FAX Properties screen appears:
For Windows® 95/98/98SE/Me

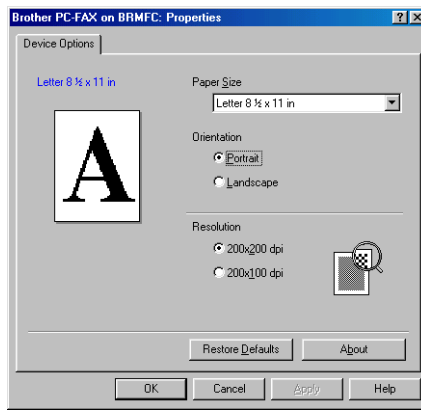

For Windows® 2000 Professional and Windows NT® WS 4.0

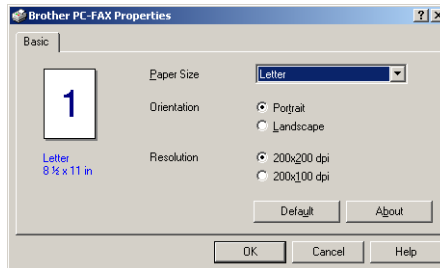

- 2 Select the Paper Size and Orientation (Portrait or Landscape) and click **OK**.



To go back to the default settings, click the **Restore Defaults** or **Default** button.

5

Using the Windows®-Based Brother SmartUI Control Center

(For Windows® XP)

Brother SmartUI Control Center

The Brother Control Center is a software utility that allows you to quite easily, with very few mouse clicks, access the most frequently used scanning applications. Using the Control Center eliminates the need to manually launch the specific applications and allows you to scan an original document directly to a folder on your computer. The Brother Control Center provides four categories of operations:

- 1 Scan directly to a file, E-mail, word processor or graphics application of your choice.
- 2 Enhanced copy functions, such as Four/Two or One-on-One Copying.
- 3 PC Faxing using the Brother PC-Fax software.
- 4 Custom buttons allow you to configure a button to meet your own application requirements.



In the Task Tray right-click on the **SmartUI**  icon and select **Show** to have access to the Brother SmartUI Control Center window.

AutoLoad the Brother Control Center

The Control Center is initially configured to automatically load each time Windows® is started. When the Control Center is loaded the **SmartUI**  icon will appear in the task bar. If you don't want the Control Center to load automatically, you can turn AutoLoad off.

How to turn off AutoLoad

- 1 Right-click the **SmartUI**  icon in the Task Tray and select **Show**.
- 2 The main SmartUI Control Center window appears. Please look at the bottom of the window for a check box labeled “AutoLoad Pop-up”.



- 3 Uncheck the AutoLoad Pop-Up option to prevent the SmartUI from automatically loading every time Windows is started.

Brother Control Center features

The SmartUI control center gives you the ability to configure the hardware **Scan** key on your MFC such as “Scan to File”. The “Scan to File” feature allows you to scan an original document directly to your hard disk and choose the file format and destination folder without having to run any other applications. Select which section you want by clicking on the appropriate tab.

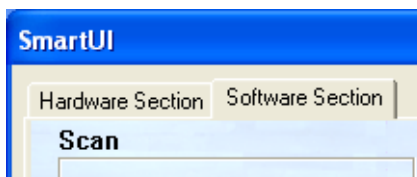

Auto Configuration

During the installation process the Control Center checks your system to determine the default applications for E-mail, word processing and graphics viewer/editor.

For example, if you are using Outlook as your default E-mail application, the Control Center automatically will create a link and a scanning application button for Outlook.

You can change the default application by right-clicking on any of the scan buttons in the Control Center and then clicking *Configuration*. Select the Configuration tab and from the Application pull down menu select a different application. For example, you can change the E-mail scan button from Outlook Express to Outlook by changing the application that is listed.

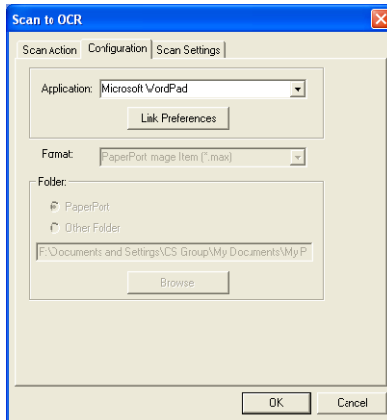

Hardware Section: Changing the Scan to button configuration

When the Brother Control Center is displayed, you can access the Hardware Section window to reconfigure the  (**Scan**) button on your MFC. Click the Hardware Section tab at the top left of the Brother SmartUI Control Center screen. (See *Using the Scan key (For USB or Parallel interface cable users)* on page 3-14.)

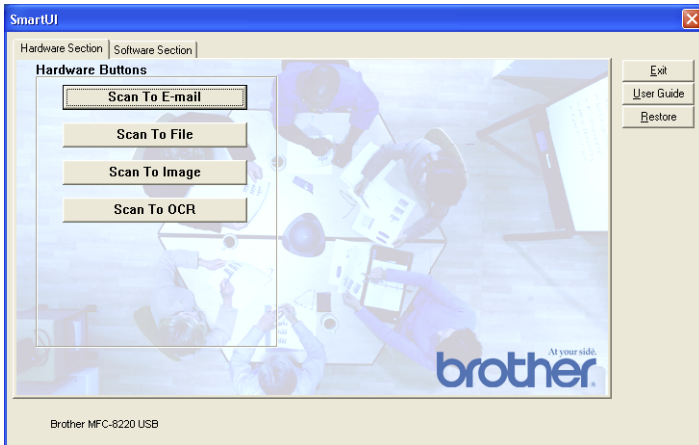

Scan to E-mail

To configure the Scan to E-mail feature left-click on the **Scan to E-mail** button and the following screen will appear. You have the ability to change the configuration that includes the destination E-mail application, attachment file and the scanner settings.

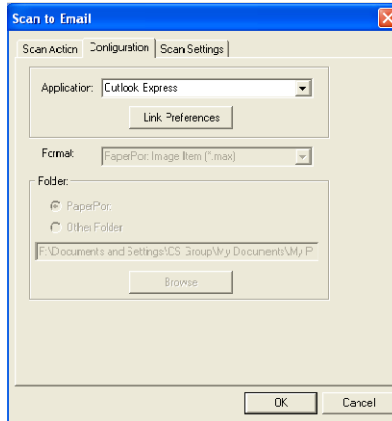

The destination E-mail application is changed by selecting another compatible E-mail application installed on your system from the Application pull down list.

If you wish to change the attachment file type click on the **Link Preferences** button to display a list of file types.

Scan to File

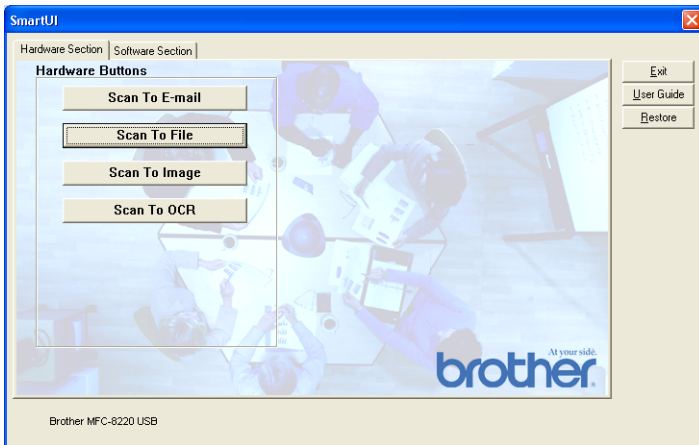

To configure the Scan to File feature, left click on the **Scan to File** button and the following screen will appear.

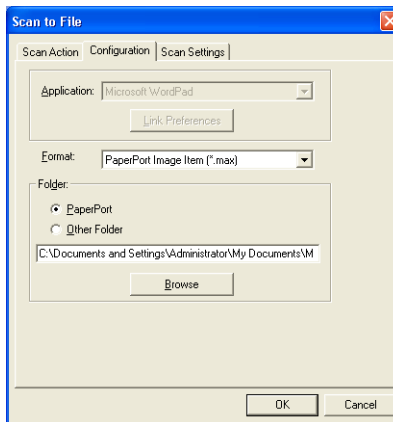

Select the file type for the saved image by selecting from the Format pull down list. You can save the file to the default PaperPort folder so the file appears in PaperPort or you can select another folder/directory by clicking the **Browse** button.

Scan to Image

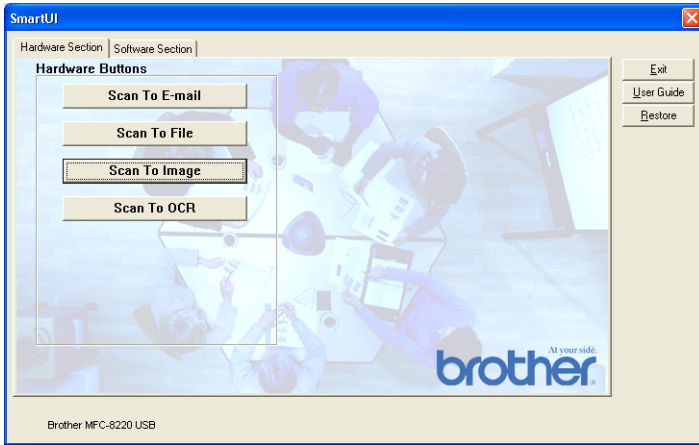

To configure the Scan to Image feature left-click on the **Scan to Image** button and the following screen will appear. You have the ability to change the configuration, which includes the destination image format or document application.

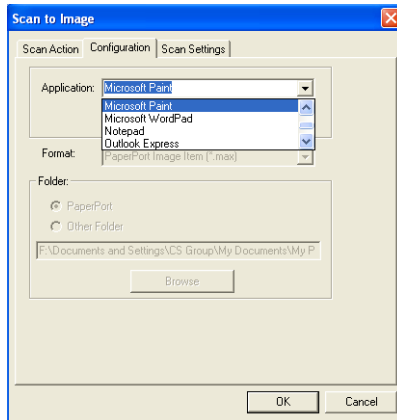

To change the default setting of the scan, click on the **Scan Settings** tab.

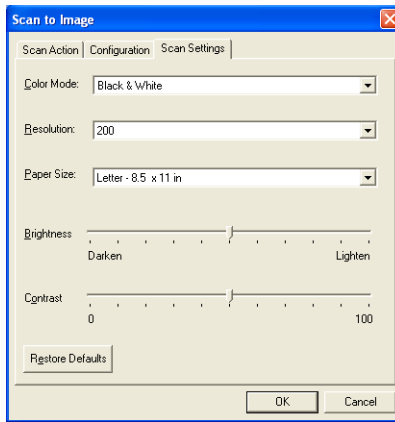

You can set the Color Mode to Black & White or 8-bit Gray.

The resolution can be changed from 100 to 1200 dpi. You can define the size of the paper you're using, and you can adjust the brightness and contrast of the image before scanning.

Scan to OCR

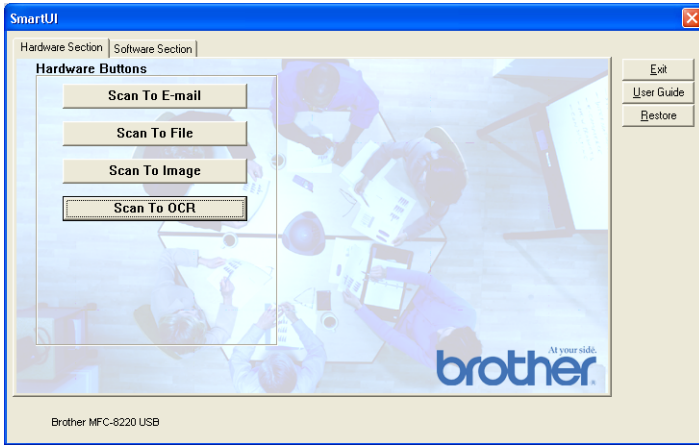

To configure the Scan to OCR feature left-click on the **Scan to OCR** button and the following screen will appear. You have the ability to change the configuration, which includes the destination applications.

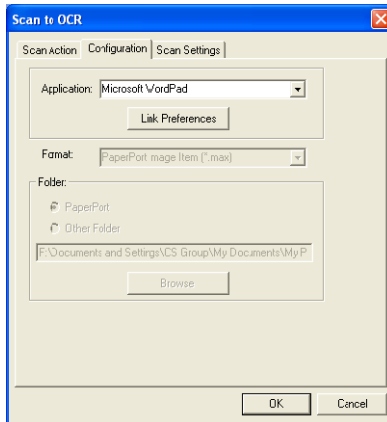

You have the option to send your scan as a different file type. You can select the application from the File Type window according to your needs.

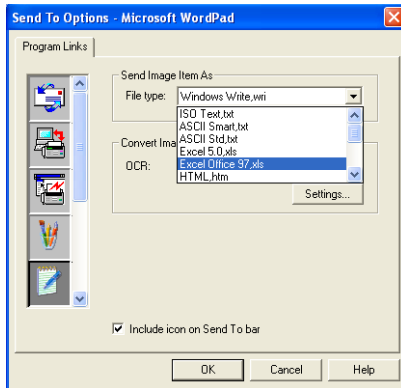

You have the option to choose your OCR setting from **Single column output** to **Auto orient page**.

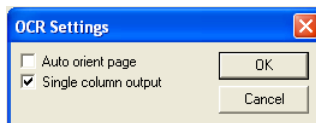

Software Section

The Software Section contains four groups of scan to buttons. Each section has a number of different buttons which are predefined for the most frequently used applications. The **Scan** section contains four buttons for Scan to File, Scan to E-mail, Scan to Word Processor and Scan to Image applications. The **Copy** section contains three buttons for N to 1 copying. The **Fax** section button is for sending faxes using the Brother PC-FAX application and the **Custom** section contains three buttons to which you can assign your own function.



Scan

*1 *Scan to File*—enables you to scan directly to a disk file. You can change the file type and destination directory, as needed.

*2 *Scan to E-mail (Default: Outlook Express)*—enables you to scan a page or original document directly into an E-mail application as a standard attachment. You have the option of selecting the file type and resolution for the attachment.

*3 *Scan to Word Processor (Default: MS WordPad)*—enables you to scan a page or original document, automatically run ScanSoft TextBridge[®] OCR and insert the text (not graphic image) into a word processing program. You have the option of selecting the destination word processing program, such as WordPad, MS Word, Word Perfect[®] or whichever word processing program is installed on your computer.

*4 *Scan to Graphic Application (Default: MS Paint)*—enables you to scan a page directly into any graphic viewer/editor application. You can select the destination application, such as MS Paint, Corel[®] Paint[™], Adobe[®] PhotoShop[®], or any kind of image editor application you already have installed on your computer.

Copy

Copy (Copy one to one)—allows you to use the PC and any Windows[®] printer driver for enhanced copy operations. You can scan the page on the MFC and print the copies using any of the features of the MFC printer driver—**OR**—you can direct the copy output to any standard Windows[®] printer driver installed on the PC including network printers.

Four/Two to One Copy—enables you to use the Four/Two on One-page features of the Brother printer driver to copy four/two original pages onto a single output page.

Fax

Send a Fax (Brother PC-FAX)—enables you to scan a page or original document and automatically send the image as a fax from the PC using the Brother PC-FAX software.

Custom

Scan to File—These buttons have been pre-programmed for the Scan to File feature. You can change the configuration of each of these buttons to meet your specific requirements by right-clicking on a button and following the configuration menus.

Scan to File

The Scan to File button allows you to scan an image and save it in a specific file type to any directory on your hard disk. This allows you to easily archive your paper original documents. To configure the file type and save to directory right-click on the **Scan to File** button and click Configuration.

The Scan Action tab is set to File and should not be changed.

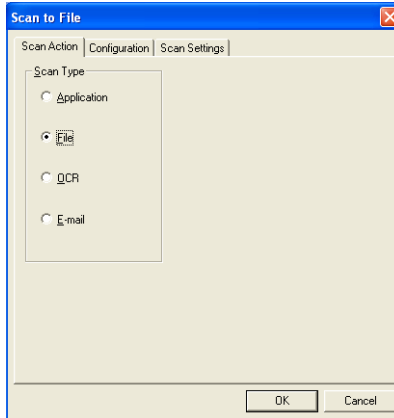

To change the configuration click on the Configuration tab.

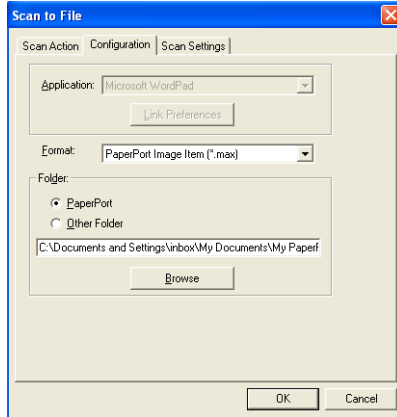

Select the file type for the saved image by selecting from the Format pull down list. You can save the file to the default PaperPort folder so the file appears in PaperPort, or you can select another folder/directory by clicking the **Browse** button.

You can change the default setting by selecting the **Other Folder** button and then clicking **Browse** and selecting the folder in which you wish to save your files.

Scan to E-mail

The Scan to E-mail is automatically configured to your default E-mail application. To change the default E-mail application or attachment file type, right-click on the E-mail button and select “Configuration”.

The Scan Action tab is set to E-mail and should not be changed.

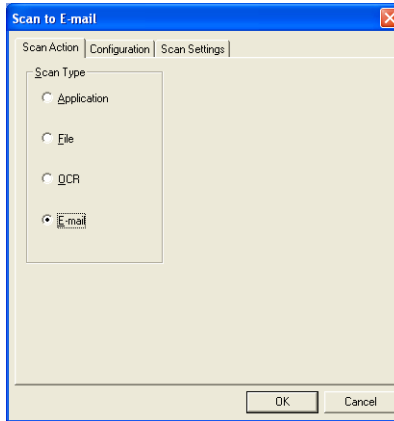

To change the E-mail application click on the Configuration tab. From the Application pull down list, select your preferred E-mail application.

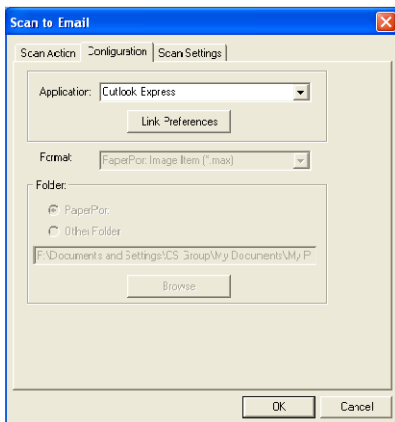

To change the file type of the attachment click the **Link Preferences** button to set up links. Check the **Convert attachment to specified file type** box and then select the appropriate file type from the pull down list.

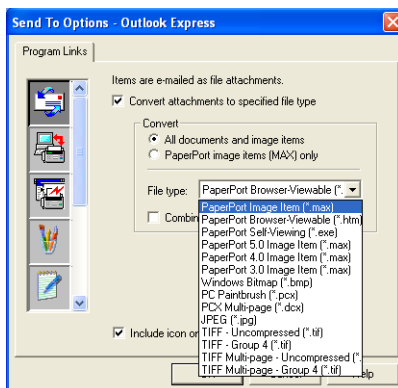

File attachments

Items are mailed as file attachments using the file type you have selected.

Convert attachments to specified file type—Click this check box if you want to change the file type of attachments.

All documents and image items—Click this check box if you want to convert all scanned images to the same file type.

PaperPort image items (MAX) only—Click this check box if you want to convert only attachments that are PaperPort MAX files.

Combine items into single file, if possible—Click this check box if you want to combine all the attachments into one file. With this box unchecked each scanned page will be saved in its own individual file.

File Type—Select from the pull-down list the type of file you want the scanned images to be saved in.

PaperPort Image Item (*.max)

PaperPort Browser-Viewable (*.htm)

PaperPort Self Viewing (*.exe)

PaperPort 5.0 Image Item (*.max)

PaperPort 4.0 Image Item (*.max)

PaperPort 3.0 Image Item (*.max)

Windows Bitmap (*.bmp)

PC Paintbrush (*.pcx)

PCX Multi-page (*.dcx)

JPEG (*.jpg)

TIFF-Uncompressed (*.tif)

TIFF Group 4 (*.tif)

TIFF Multi-Page -Uncompressed (*.tif)

TIFF Multi-Page - Group 4 (*.tif)

Scanner settings

You have the ability to change the scanner settings used to create the file attachments. Click on the Scan Settings tab and select the appropriate settings.

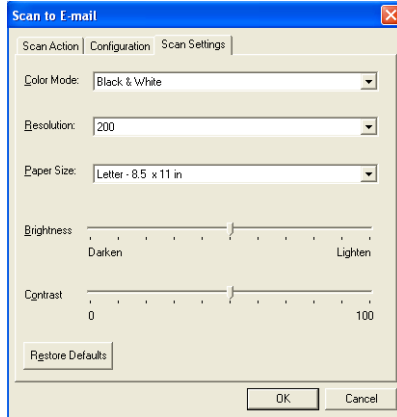

Scan to OCR (Word Processing program)

Scan to OCR converts the graphic page image data to text which can be edited by any word processor program. You can change the default word processor program (example: Word Pad instead of Word) and file type. You can also choose another OCR software package besides the TextBridge® OCR which is built into PaperPort®.

To configure Scan to OCR right-click on the WordPad button and select Configuration. The Scan Action tab is set to OCR and should not be changed.

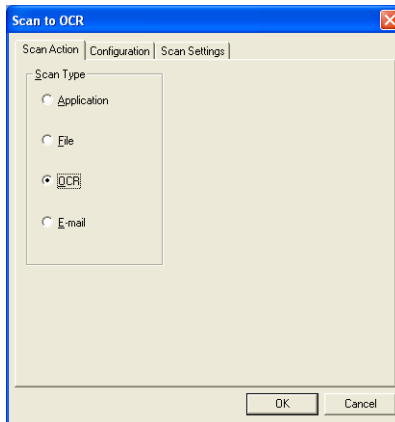

To change the word processing application click on the Configuration Tab. You can select the destination word processing application from the Application pull down list.

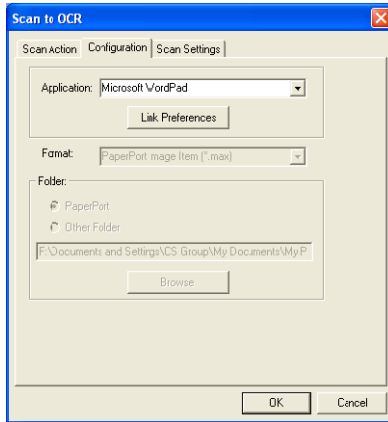

To change the program link preferences click the **Link Preferences** button.

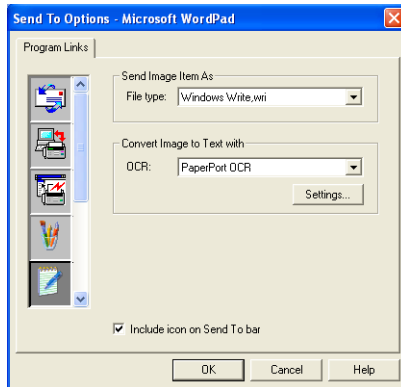

File Type—From the pull-down list, select the file format you want to use for original documents.

OCR—Select the OCR application from the OCR pull down list.

Scan to Graphics application (example: Microsoft Paint)

The Scan to Graphics Application allows you to scan an image so you can edit the image. To change the default graphics application right-click on the button and select Configuration.

The Scan Action tab is set to Application and should not be changed.

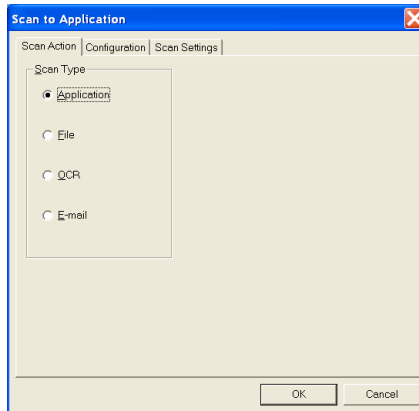

To change the configuration of the destination application click on the Configuration Tab.

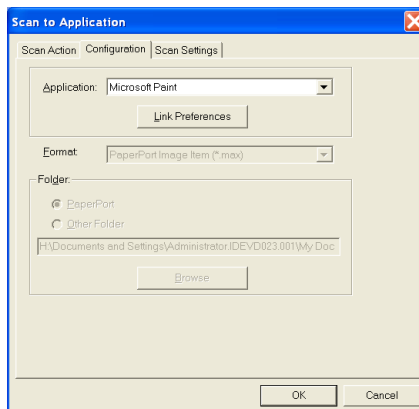

To change the destination application select the appropriate application from the Application pull down list.

To change the other configuration options click the **Link Preferences** button.

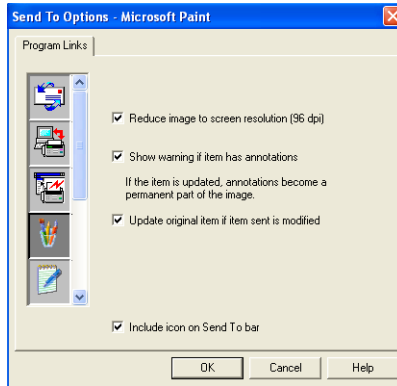

These options enable you to reduce image to screen resolution (96dpi), show a warning if the item has annotations or update the original if the sent item is modified.

Copy

The copy buttons can be customized to allow you to take advantage of the features built into the Brother printer drivers to do advanced copy functions such as n-in-1 printing.

The **Copy** buttons are automatically linked to the default Windows printer driver. You can set any printer as the default printer including non-Brother printers. Before you can use the **Copy** buttons you must first configure the printer driver by right-clicking on a **Copy** button and selecting Configuration.

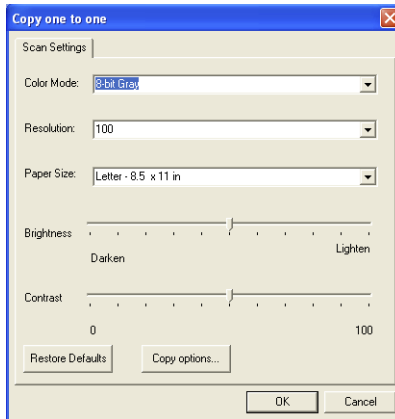

In the Scan Settings window you can select the color mode, resolution, paper size, brightness and contrast settings to be used. To finish the **Copy** button configuration you must set the printer driver. Click the **Copy options** button to display the printer driver settings.

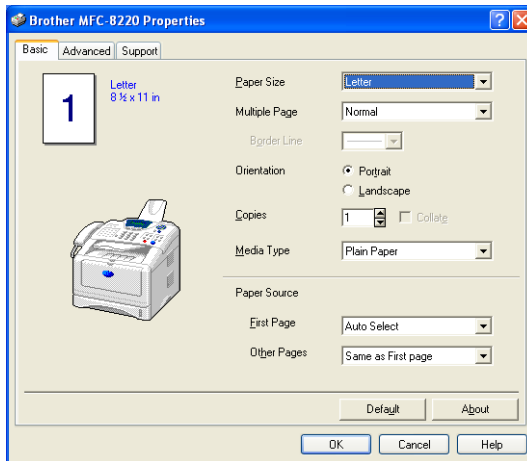

Select the number of Pages Per Sheet from the Scaling selections. As an example, to configure the section Copy button to copy two pages to one you must select 2 in 1.



You must configure each of the copy buttons before they can be used.

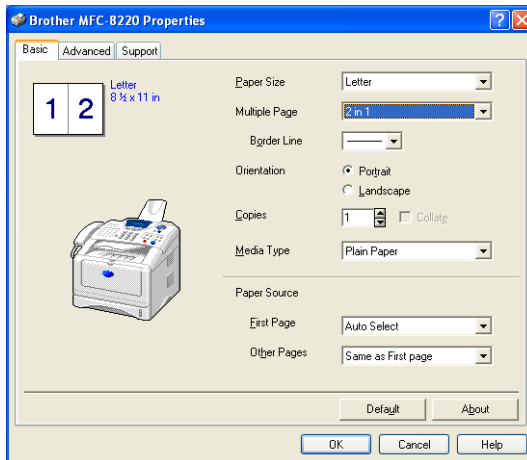

Fax setting (PC-Fax using the Brother Fax Driver)

The MFC includes a PC-Fax driver, which allows any Windows Application to send a Fax as simply as printing an original document. The Brother SmartUI Control Center automatically configures the **Fax** button to use the Brother PC-FAX driver, no user configuration is required.

The Scan Action tab is set to Application and should not be changed.

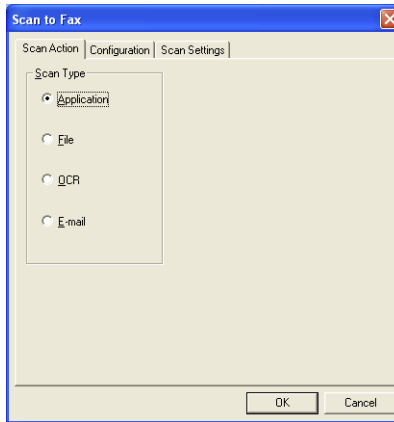

To change the PC-FAX settings click the **Link Preferences** button found in the configuration tab.

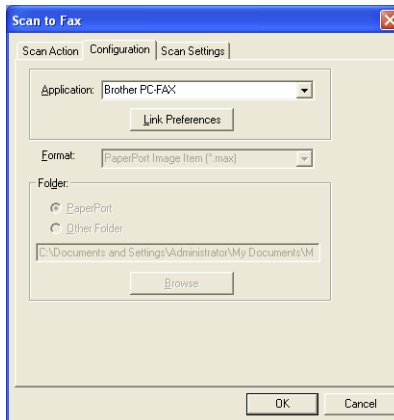

FAX settings

Brother PC-FAX

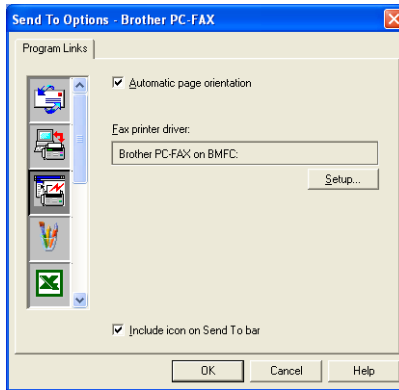

To change the driver settings, click on the **Setup** button. Select the *Paper Size*, *Paper Source*. If you need more a customized setup, click on the **Options** button.

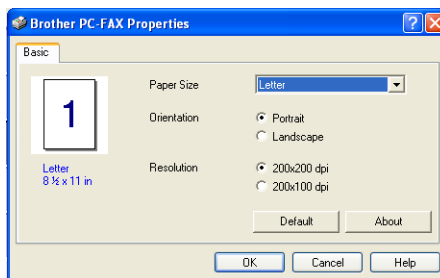
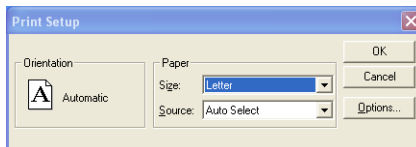

Select the *Paper Size*, Orientation (Portrait or Landscape) and Resolution (200x200 dpi or 200x100 dpi), and click **OK**.

To return to the default settings, click the **Default** button.

Custom: User-defined buttons

There are up to three **Custom** buttons on the Brother SmartUI Control Center. You can set your own preferences and configuration to fit your required application.

To configure a **Custom** Button right click on the button and then click Configuration. The configuration window will appear. You have four function choices Application, File, OCR and E-mail.

Application: This setting will link the Control Panel button to any button which appears on the PaperPort Send to Bar. Please see the PaperPort help file for more information regarding PaperPort compatible applications.

File: This setting allows you to save a scanned image to any directory on local or network hard disk. You can also select the file format to be used.

OCR: Scanned original documents will be converted to editable text files. If you have a third party OCR software package installed on your PC you can select it. The default OCR software is TextBridge® which is built into PaperPort 8.0. You can also select the destination word processor and file format for the editable text.

E-mail: Scanned images will be attached to an E-mail message. You can choose which E-mail package to use if you have more than one installed on your system. You can also select the file type for the attachment.

Customizing a user-defined button

To configure a **Custom** button right-click on the button and then click Configuration. Please follow the following guide lines for **Custom** Button configuration.

1. Select the Scan Action

Select the type of scan by clicking the appropriate button.

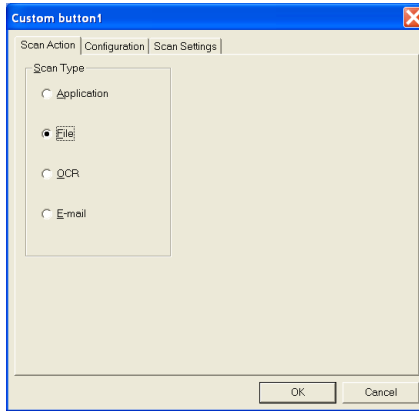

2. Select Configuration for the Scan Type.

To configure the scan operation click on the Configuration Tab. Depending upon which **Scan Type** button you selected you will see a different Configuration Tab list of settings.

Application:

Select the destination application program from the pull down list.

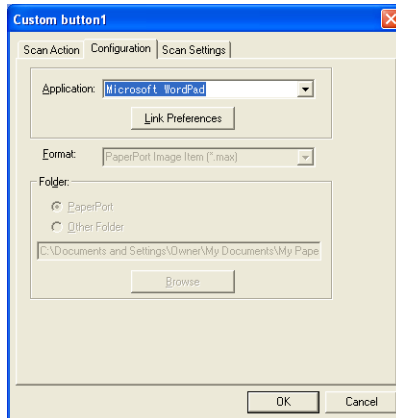

Click on Link Preferences to set the Send to options. You can select the application from the scroll menu on the left.

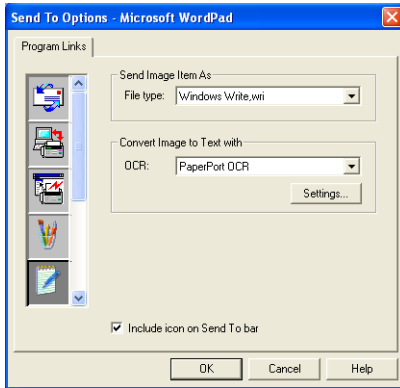

File:

Select the file format from the Format pull down list. You can either send the file to the default PaperPort directory or select your own destination directory by selecting Other Folder. Use the **Browse** button to select the destination directory.

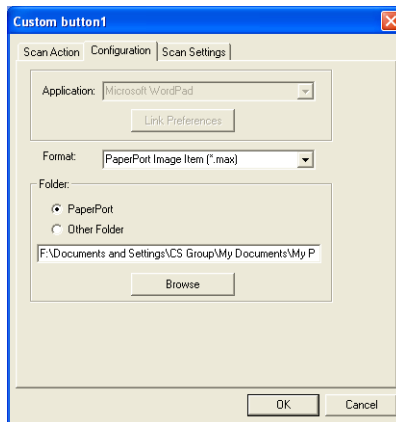

OCR:

Select the destination word processing application program from the pull down list.

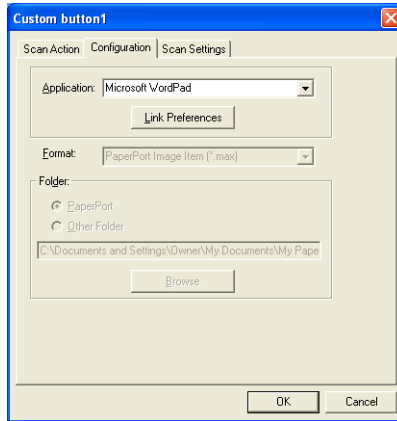

Click on Link Preferences and select the destination Application from the scroll menu on the left. Select the File Type from the File Type pull down list. You can also choose another OCR application from the OCR pull down list if another is installed on your system. Scansoft® TextBridge® is installed as part of the PaperPort 8.0 application.

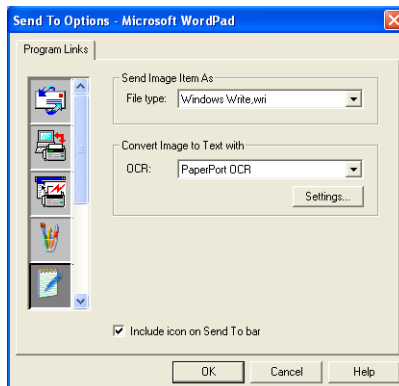

E-mail:

Select the destination E-mail application program from the pull down list.

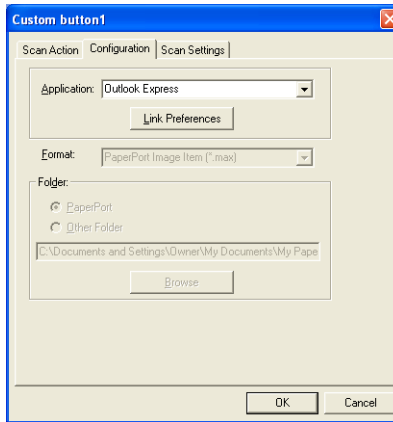

Click on the **Link Preferences** button to configure the Send To E-mail options. You can select the File type and Quick Send E-mail address list.

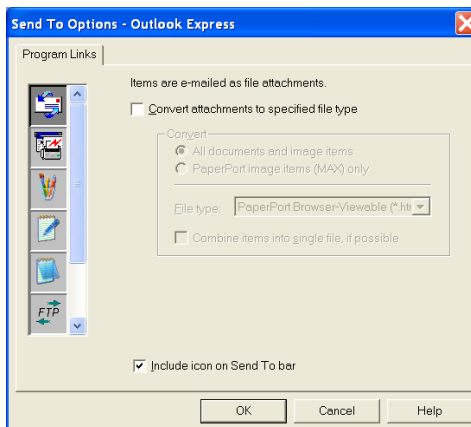

3. Select Scan Settings.

You can select the scanner settings from each of the Scan Type options for the Custom buttons. You have the option to select Color Mode, Resolution, Paper Size and Brightness and Contrast settings.

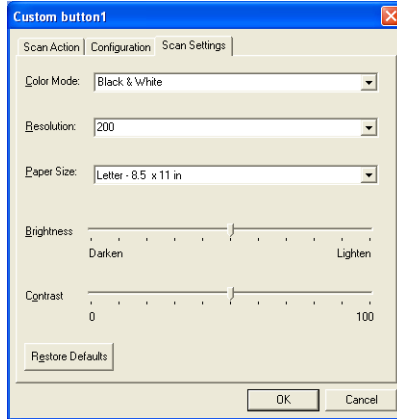

6

Using MFC Remote Setup

(For Windows®)

MFC Remote Setup

The MFC Remote Setup application enables you to configure your MFC using an intuitive graphical user interface (GUI) on your PC. When you access this application, the settings on your MFC will be downloaded to your PC and displayed on your computer screen. If you change the settings, you can upload them directly to the MFC.



You can't use the MFC Remote Setup application if your MFC is only connected to a Network with the optional Network LAN board (NC-9100h). (See Web Based Management in the NC-9100h User's Guide.)

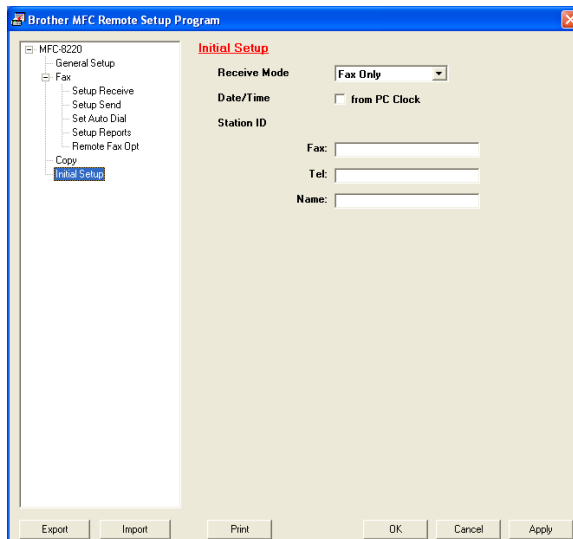

OK button

When you click **OK**, the process of uploading the data to the MFC begins. The MFC Remote Setup program is closed if an error message is displayed, enter the correct data again and then click **OK**.

Cancel button

The **Cancel** button clears your changes and exits the MFC Remote Setup application without uploading any data to the MFC.

Apply button

The **Apply** button uploads the data to the MFC, but stays in the Remote Setup application so you can make more changes.

Print button

The **Print** button prints the selected items on the MFC. You cannot print the MFC Remote Setup changes until you click the **Apply** button to upload the new data to the MFC. You can then click the **Print** button to get an up-to-date printout.

Export button

Click the **Export** button to save your current settings to a file.

Import button

Click the **Import** button to read the settings from your saved file into the MFC Remote Setup screen.



You can use the **Export** and **Import** buttons to save and use several sets of settings for your MFC.

7

Using Brother PC-FAX software

(For Windows®)

PC-FAX sending

The Brother PC-FAX feature allows you to use your PC to send any application or document file as a standard fax. You can create a file in any application on your PC, and then send it as a PC-FAX. You can even attach a cover page note. All you have to do is set up the receiving parties as Members or Groups in your PC-FAX Address Book or simply enter the destination address or fax number into the User Interface. You can use the Address Book Search feature to quickly find members to send your fax.



- PC-FAX is available in Black & White only.
- If you are using Windows® XP, Windows NT® 4.0 or Windows® 2000 Professional, we recommend that you are logged on with administrator rights.
- Please check Brother Solutions Center for the latest updates available for Brother Network PC-FAX. Visit <http://solutions.brother.com/>

Setting up user information



You can access the User Information from the FAX Sending dialog box by clicking .

(See *Sending a file as a PC-FAX using the Facsimile style* on page 7-16.)

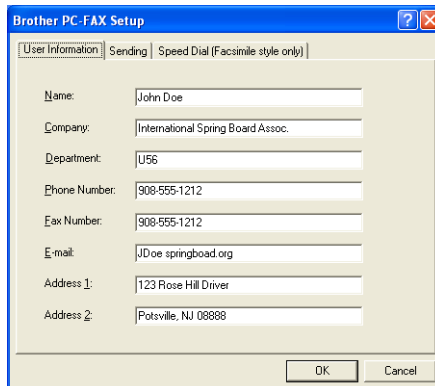

The screenshot shows the 'Brother PC-FAX Setup' dialog box with the 'User Information' tab selected. The dialog box contains several text input fields for user details. The fields are: Name (John Doe), Company (International Spring Board Assoc.), Department (U56), Phone Number (908-555-1212), Fax Number (908-555-1212), E-mail (JDoe@springboard.org), Address 1 (123 Rose Hill Drive), and Address 2 (Potsville, NJ 08888). At the bottom right, there are 'OK' and 'Cancel' buttons.

Name:	John Doe
Company:	International Spring Board Assoc.
Department:	U56
Phone Number:	908-555-1212
Fax Number:	908-555-1212
E-mail:	JDoe@springboard.org
Address 1:	123 Rose Hill Drive
Address 2:	Potsville, NJ 08888

- 1 From the **Start** menu, select **Programs**, **Brother**, **MFL-Pro Suite MFC-8220**, and then select **PC-FAX Setup**. The **Brother PC-FAX Setup** dialog box will appear:
- 2 You must enter this information to create the Fax Header and Cover Page.
- 3 Click **OK** to save the **User Information**.

Sending setup

From the **Brother PC-FAX Setup** dialog box, click the **Sending** tab to display the screen below.

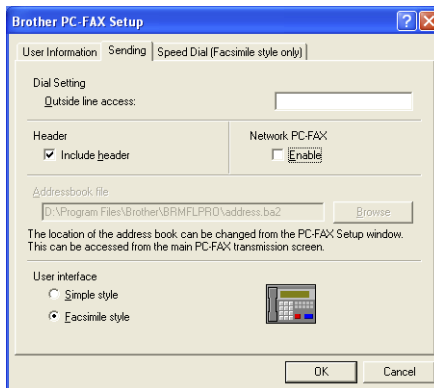

The include header option adds header information to the top of the fax pages you send.

The user has the choice of two user interfaces: Simple style or Facsimile style. To change the user interface select the interface setting you want: Simple style or Facsimile style. (See *User interface* on page 7-5.)

Outside line access

If you need to enter a number to access an outside line, enter it here. This is sometimes required by a local PBX telephone system (for example if you must dial 9 to get an outside line in your office).

Include header

To add header information to the top of the fax pages you send, check the Include header box.

Address Book file

You can select more than one database file to use with the Address Book. To select you must enter the path and file name of the database file.

—OR—

Use the **Browse** button to find the database to select.

User interface

In the **Sending** tab, select user interface.

You can choose the **Simple Style** or the **Facsimile Style**.

Simple style

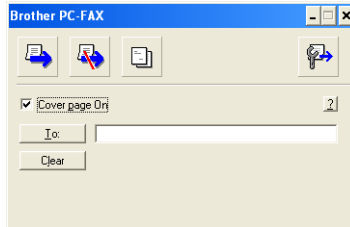

Facsimile style



Speed-Dial setup

From the **Brother PC-FAX Setup** dialog box, click the **Speed Dial** tab. (To use this feature you must select the **Facsimile Style** user interface.)

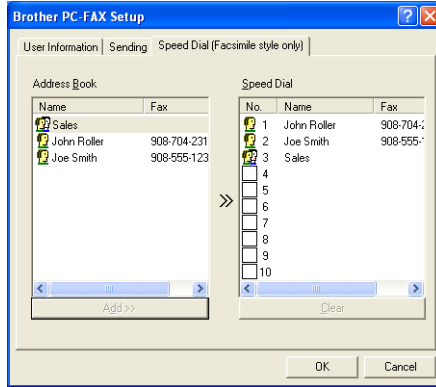

You can register a Member or Group on each of the ten Speed-Dial buttons.

To register an address in a Speed-Dial button:

- 1 Click the Speed-Dial button you want to program.
- 2 Click the Member or Group you want to store on the Speed-Dial button.
- 3 Click **Add >>** to save it.

To clear a Speed-Dial button:

- 1 Click the Speed-Dial button you want to clear.
- 2 Click **Clear** to erase it.

The Address Book

From the **Start** menu, select **Programs, Brother, MFL-Pro Suite MFC-8220**, and then click **PC-FAX Address Book**.

The **Brother Address Book** dialog box will appear:

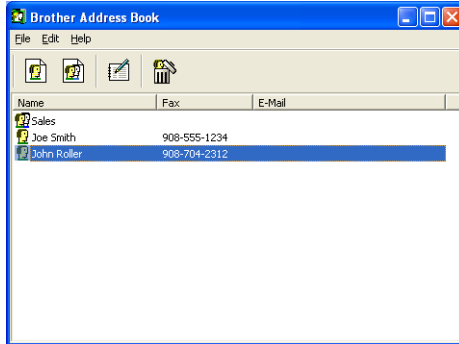

Setting up a Member in the Address Book

In the **Brother Address Book** dialog box you can add, edit and delete stored information of Members and Groups.

- 1 In the Address Book dialog box, click the  icon to add a Member.

The **Brother Address Book Member Setup** dialog box will appear:

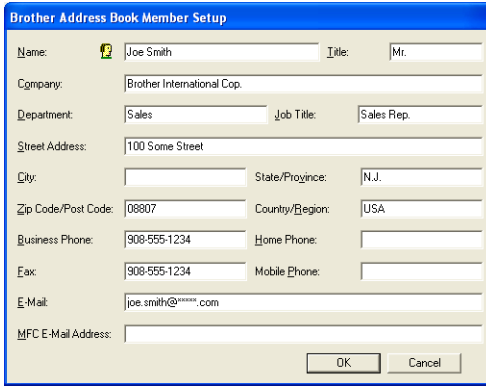

Brother Address Book Member Setup

Name: Title:

Company:

Department: Job Title:

Street Address:

City: State/Province:

Zip Code/Post Code: Country/Region:

Business Phone: Home Phone:

Fax: Mobile Phone:

E-Mail:

MFC E-Mail Address:

- 2 In the Member Setup dialog box, type the Member's information. **Name** is a required field. Click **OK** to save the information.

Setting up a Group for Broadcasting

If you often send the same PC-FAX to several Members, you can combine them in a Group.

- 1 In the **Brother Address Book** dialog box, click the  icon to create a Group.

The Group Setup dialog box appears:

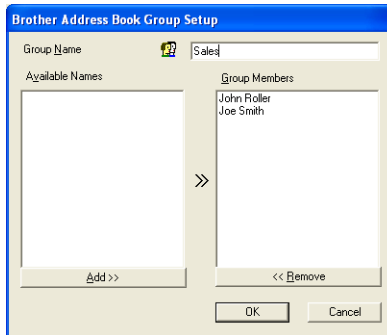

- 2 Type the name of the new Group in the **Group Name** field.
- 3 In the **Available Names** box, select each Member to be included in the Group, and then click **Add >>**.
Members you add to the Group will be added to the **Group Members** box.
- 4 After all the members you want have been added, click **OK**.

Editing Member information

- 1 Select the Member or Group you want to edit.
- 2 Click the edit  icon.
- 3 Change the Member or Group information.
- 4 Click **OK** to save your changes.

Deleting a Member or Group

- 1 Select the Member or Group you want to delete.
- 2 Click the delete  icon.
- 3 When the **Confirm Item Delete** dialog box appears, click **OK**.

Exporting the Address Book

You can export the whole Address Book to an ASCII text file (*.csv). Or if you wish, you can select and create a Vcard that will be attached to that Member's outgoing E-mail. (A Vcard is an electronic business card that contains the sender's contact information.)

To export the whole current Address book:



If you are creating a Vcard, you must first select the member.

If you select Vcard in Step 1, **Save as type:** will be **Vcard (*.vcf)**.

- 1 From the Address Book select **File**, point to **Export**, and then click **Text**.

—OR—

Click **Vcard** and go to Step 5.

- 2 From the **Available Items** column, select the data fields you wish to Export and then click **Add >>**.



Select the items in the order you want them listed.

- 3 If you are exporting to an ASCII file, select the **Divide Character - Tab** or **Comma**. This selects between a **Tab** or **Comma** to separate the data fields.
- 4 Select **OK** to save the data.

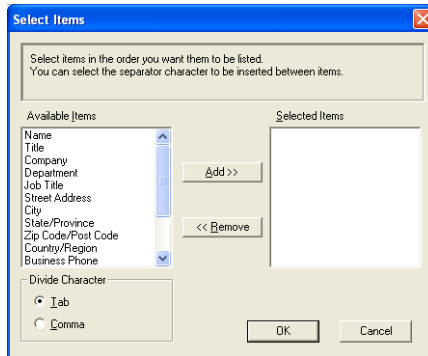

- 5 Type the name of the file, and then select **Save**.

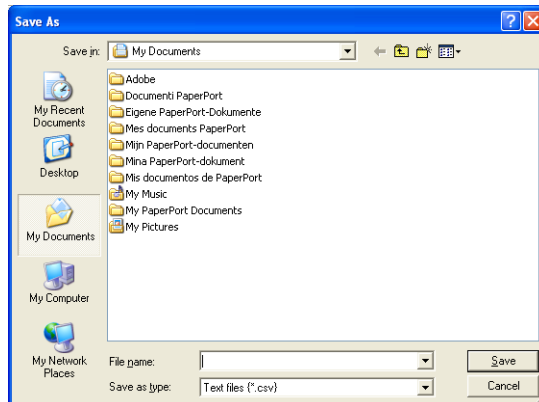

Importing to the Address Book

You can import ASCII text files (*.csv) or Vcards (electronic business cards) into your Address Book.

1 From the Address Book select **File**, point to **Import**, and then click **Text**.

—OR—

Click **Vcard** and go to Step 5.

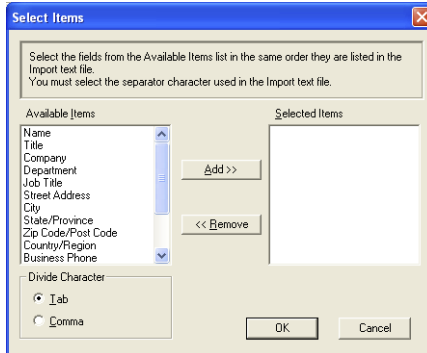

2 From the **Available Items** column select the data fields you want to Import, and click **Add >>**.





From the Available Items list select the fields in the same order they are listed in the Import text file.

3 Select the **Divide Character - Tab** or **Comma** based on the file format you are importing.

4 To import the data click **OK**.

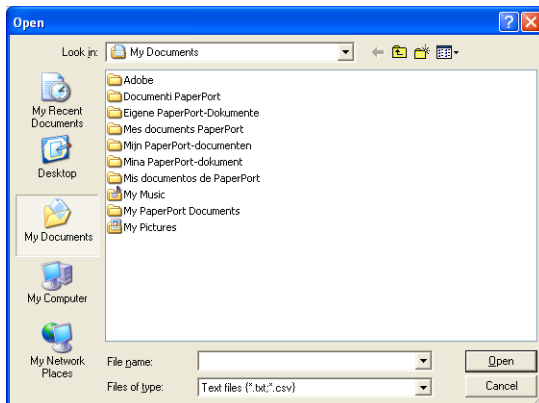
5 Type the name of the file, and then select **Open**.



 If you selected a text file in Step 1, the **Files of type:** will be **Text file (*.csv)**.

Setting up a Cover Page

From the PC-FAX dialog box click  to access the PC-Fax Cover page setup screen. (See *Sending a file as a PC-FAX using the Facsimile style* on page 7-16.)

The **Brother PC-FAX Cover Page Setup** dialog box will appear:

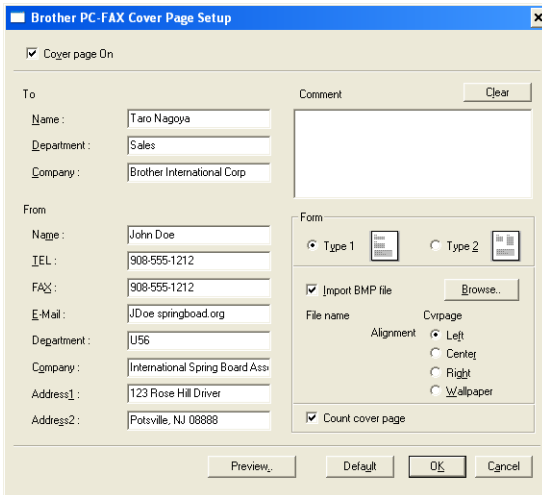

The dialog box is titled "Brother PC-FAX Cover Page Setup" and contains the following fields and options:

- Cover page On
- To:**
 - Name: Taro Nagoya
 - Department: Sales
 - Company: Brother International Corp
- From:**
 - Name: John Doe
 - FAX: 908-555-1212
 - E-Mail: JDoe@springboard.org
 - Department: U56
 - Company: International Spring Board Ass
 - Address1: 123 Rose Hill Drive
 - Address2: Potsville, NJ 08888
- Form:**
 - Type 1 (selected) or Type 2
 - Import BMP file (with Browse... button)
 - File name: _____
 - Cvpage: _____
 - Alignment: Left, Center, Right
 - Wallpaper
 - Count cover page
- Comment:** (with Clear button)

Buttons at the bottom: Preview..., Default, OK, Cancel

You can enter information in each field



If you are sending a fax to more than one recipient, the recipient information will not be printed on the Cover Page.

To

From

Comment

Type the comment you want to add to the cover page.

Select Cover Page Form

Select the cover page format you want to use.

Import BMP file

You can insert a bitmap file, such as your company logo, in the cover page.

Use the browse button to select the BMP file, and then select the alignment style.

Count Cover Page

When the Count Cover Page box is checked, the Cover Page will be included in the page numbering. When this box is not checked, the Cover Page will not be included.

Sending a file as a PC-FAX using the Facsimile style

- 1 Create a file in Word, Excel, Paint, Draw or any other application on your PC.
- 2 From the **File** menu, select **Print**.
The **Print** dialog box will appear:

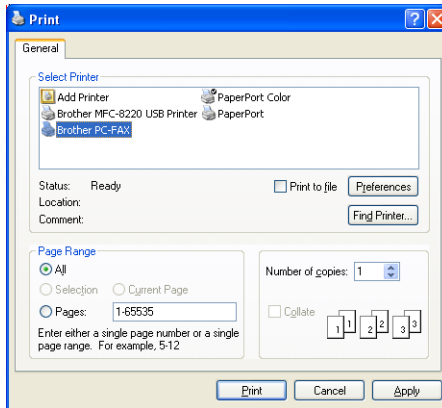



- 3 Select **Brother PC-FAX** as your printer, and then click **OK**.
The Fax Sending dialog box will appear.



- 4** Enter the fax number using any of the following methods:
- Using the dial pad enter the number.
 - Click any of the 10 **Speed-Dial** buttons.
 - Click the **Address Book** button, and then select a Member or Group from the Address Book.

 If you make a mistake you can click **Clear** to delete all the entries.

- 5** To include a Cover Page, click  **Cover Page On**, and then click the Cover Page  icon to enter or edit the Cover Page information.

- 6** Click **Start** to send the fax.

 If you want to cancel the fax, click **Stop**.

Redial

If you want to redial a number, click **Redial** to scroll through the last five fax numbers, and then click **Start**.



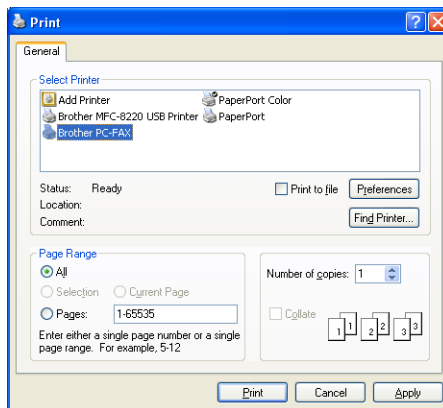

Sending a file as a PC-FAX using the Simple style

- 1** Create a file in Word, Excel, Paint, Draw or any other application on your PC.
- 2** From the **File** menu, select **Print**.
The **Print** dialog box will appear:

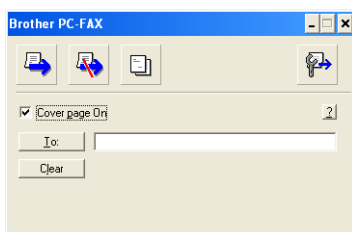

- 3** Select **Brother PC-FAX** as your printer, and then click **OK**. The FAX Sending dialog box will appear:



- 4** In the **To:** field, type the fax number of the recipient. You can also use the Address Book to select destination fax numbers by clicking the **To:** button. If you made a mistake entering a number, click the **Clear** button to delete all the entries.
- 5** To send a Cover Page and note, click the **Cover Page On** check box.
-  You can also click the  icon to create or edit a cover page.
- 6** When you are ready to send your fax, click the Send  icon.
- 7** If you wish to cancel the fax, click the Cancel  icon.

Setting up PC-FAX receiving (Windows® 95/98/98SE/Me/2000 Professional and Windows NT® WS 4.0 only)



For Windows® XP

See *Receiving a fax into the PC (Windows® XP only)* on page 7-21.



PC-FAX receiving is only available when using the USB or parallel connection, not the LAN connection.

Running PC-FAX Receiving

From the **Start** menu, select **Programs, Brother, MFL- Pro Suite MFC-8220** and then select '**PC-FAX Receiving**'.

The PC-FAX  icon will appear on your PC Task bar for this Windows® session.

Setting up your PC

- 1 Right-click the PC-FAX  icon on your PC Task Bar, and then click **PC-Fax RX Setup**.
- 2 The PC-Fax RX Setup dialog box will appear:

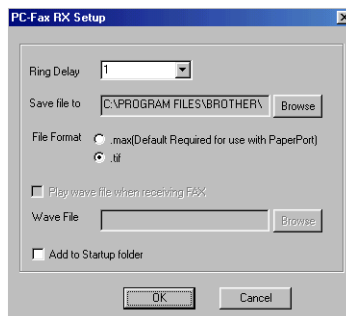

- 3** In **Ring Delay**, select the number of rings before you want your PC to answer incoming calls.
- 4** In **Save file to**, use the Browse button if you want to change the path where PC-FAX files will be saved.
- 5** In **File Format**, select **.tif** or **.max** for the format the received original document will be saved in. The default format is **.tif**.
- 6** If you want to, you can check the **Play wave file when receiving FAX** check box, and then enter the path.
- 7** To load PC FAX receiving automatically when you start up Windows®, select the **Add to Startup folder** check box.

Viewing new PC-FAX messages

Each time you start to receive a PC-FAX, the icon will flash  blue and red. Once the fax has been received the icon will remain red. The red icon will change to green once the received fax has been viewed.

- 1** Run PaperPort.
- 2** Open the Fax Received folder.
- 3** Double-click any of the new faxes to open and view them.

 The title of your unread PC message will be the date and time until you assign a file name.

For example “Fax 2-20-2002 16:40:21.tif”

Receiving a fax into the PC (Windows® XP only)

 For Windows® 95/98/98SE/Me/2000 Professional and Windows NT® WS 4.0

See *Setting up PC-FAX receiving (Windows® 95/98/98SE/Me/2000 Professional and Windows NT® WS 4.0 only)* on page 7-19.

 PC-FAX receiving is only available when using the USB or parallel connection, not the LAN connection.

How to receive a fax automatically

Before you can start receiving faxes, please install the appropriate Windows XP driver (Windows XP In-box driver or Brother Windows XP driver). After the driver is installed, refer to the following information to configure your Windows XP PC for Fax receiving.

- 1** To activate Faxing receiving, click **Set up faxing** in the **Printer Tasks** menu.

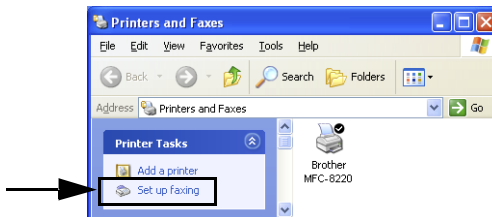

- 2** The FAX services will be installed on your PC.

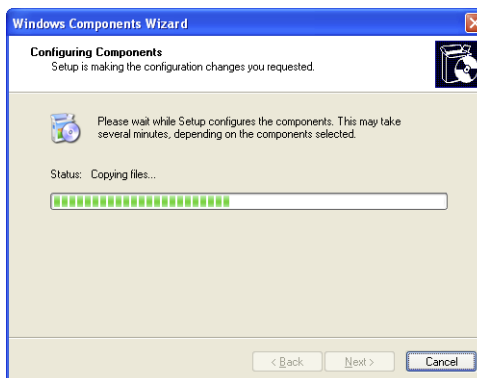

- 3 A **Fax** icon will then appear in the **Printers and Faxes** folder. If the **Fax** icon does not appear, click **Install a local fax printer** in the **Printer tasks** menu.



- 4 Select the **Start, All Programs, Accessories, Communications, Fax, Fax Console**.



If you have not configured your fax connection, the following screen will be displayed.

Enter your details, ensuring you specify the outside line access number if necessary and click **OK**.

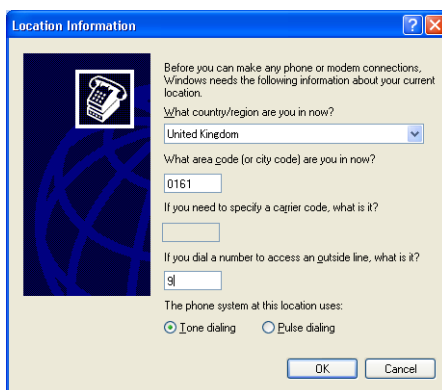

Select the **My location** radio button if it is not selected and then click **OK**.

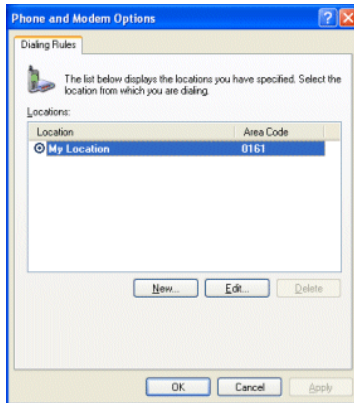

5 The **Fax Configuration Wizard** starts. Click **Next**.



6 Enter the sender information, and then click **Next**.

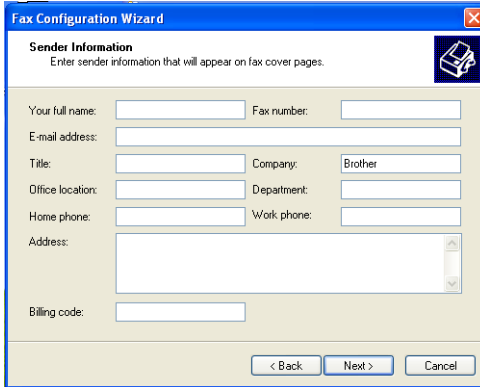

The screenshot shows the 'Fax Configuration Wizard' window with the 'Sender Information' tab selected. The window title is 'Fax Configuration Wizard' and the subtitle is 'Sender Information'. Below the subtitle, it says 'Enter sender information that will appear on fax cover pages.' There is a printer icon in the top right corner. The form contains the following fields: 'Your full name:' (text box), 'Fax number:' (text box), 'E-mail address:' (text box), 'Title:' (text box), 'Company:' (text box with 'Brother' entered), 'Office location:' (text box), 'Department:' (text box), 'Home phone:' (text box), 'Work phone:' (text box), 'Address:' (text area), and 'Billing code:' (text box). At the bottom, there are three buttons: '< Back', 'Next >', and 'Cancel'.

7 Select **Brother MFC-8220** in the **Please select the fax device** pull-down list. Click to select the **Enable Receive** check box. Specify the number of rings before your MFC will attempt to answer the fax. Click **Next**.

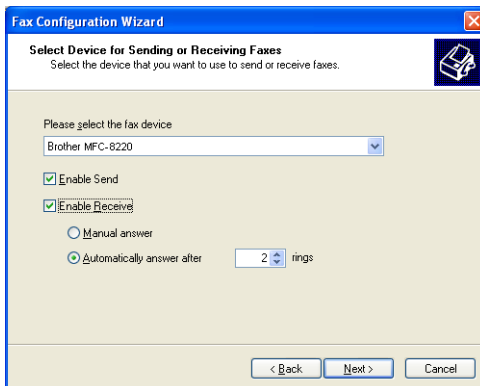

The screenshot shows the 'Fax Configuration Wizard' window with the 'Select Device for Sending or Receiving Faxes' tab selected. The window title is 'Fax Configuration Wizard' and the subtitle is 'Select Device for Sending or Receiving Faxes'. Below the subtitle, it says 'Select the device that you want to use to send or receive faxes.' There is a printer icon in the top right corner. The form contains the following elements: 'Please select the fax device' (pull-down menu with 'Brother MFC-8220' selected), 'Enable Send' (checked checkbox), 'Enable Receive' (checked checkbox), 'Manual answer' (radio button), 'Automatically answer after' (radio button selected), and a spinner box set to '2' rings. At the bottom, there are three buttons: '< Back', 'Next >', and 'Cancel'.

- 8 Enter the **Transmitting Subscriber Identification (TSID)**, and then click **Next**.

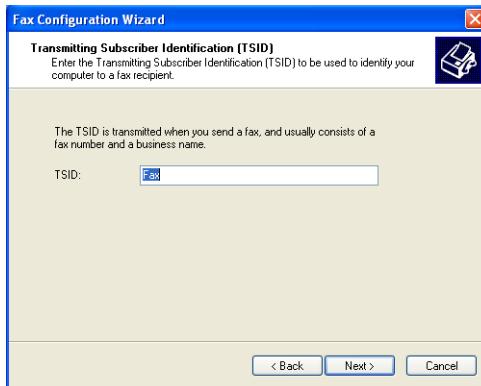

- 9 Enter the **Called Subscriber Identification (CSID)**, and then click **Next**.

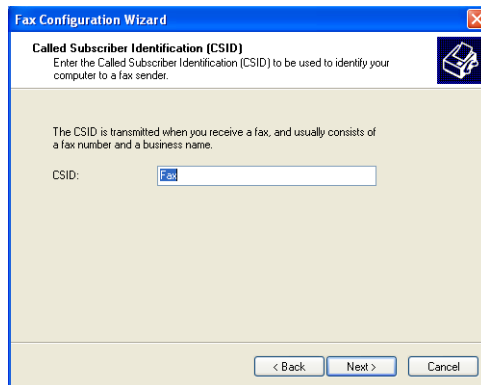

10 Select if you print a received fax or save it in a folder, and then click **Next**.

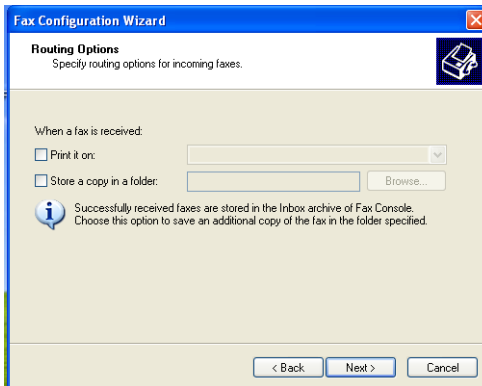

11 Click **Finish**.

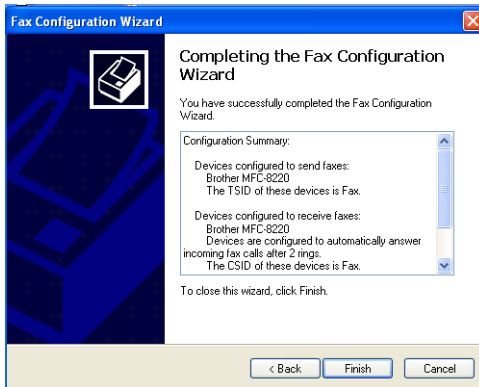

 When PC-FAX Receiving is active, you cannot run the Remote Setup utility. To use Remote Setup, check off **Enable Receive** in Step 7.

For information on how to use PC-FAX Sending and Receiving, please refer to Help in the **Fax Console**.

The PC-FAX installation is now complete.

How to view the received faxes

Faxes that are received into the PC will appear in the Fax Console. Click **Start**, point to **All Programs, Accessories, Communications, Fax**, and then click **Fax Console** to open the **Fax Console**. In the left panel, expand the Fax folder (if it is not already expanded).

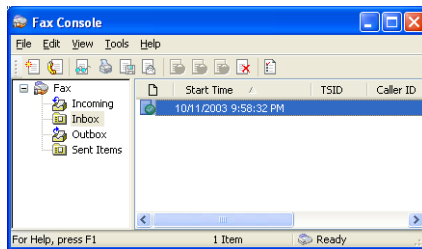

The Fax folder contains the following folders:

- The Incoming folder contains faxes that are currently being received.
- The Inbox folder contains faxes that have been received.
- The Outbox folder contains faxes that are scheduled to be sent.
- The Sent Items folder contains faxes that have been successfully sent.

8

Using your MFC with a Macintosh®

Setting up your USB-equipped Apple® Macintosh®



Before you can connect the MFC to your Macintosh®, you must buy a USB cable that is not longer than 6 feet (1.8 meters).

Do not connect the MFC to a USB port on a keyboard or a non-powered USB hub.

The features supported by the MFC will depend on the operating system you are using. The chart below shows which features are supported.

Feature	Mac OS®		Mac OS® X	
	8.6	9.X	10.1	10.2.1-10.3 or greater*1
Printing	Yes	Yes	Yes	Yes
Scanning (TWAIN)	Yes	Yes	No	Yes
PC-FAX sending	Yes	Yes	Yes	Yes
Remote Setup	No	No	Yes	Yes

*1 For Mac OS® X 10.2 users, please upgrade to Mac OS® X 10.2.1-10.3 or greater. (For the latest information for Mac OS® X, please visit at: <http://solutions.brother.com>)

Using the Brother printer driver with your Apple® Macintosh® (Mac OS® 8.6-9.2)

To select a Printer:

- 1 Open the **Chooser** from the Apple menu.

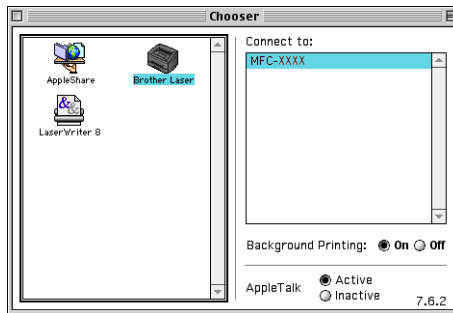

- 2 Click the **Brother Laser** icon. On the right side of the **Chooser** window, click the printer you want to print to. Close the **Chooser**.

To print an original document:

- 1 From the application software such as Presto!® PageManager®, click the **File** menu and select **Page Setup**. You can change the settings for **Paper Size**, **Orientation**, and **Scaling**, and then click **OK**.

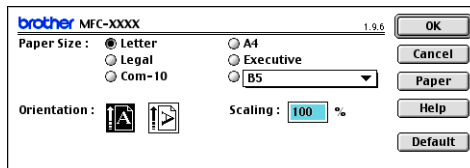

- 2 From application software such as Presto!® PageManager®, click **File** menu and select **Print**. Click **Print** to start printing.

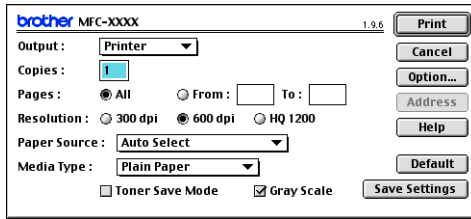

If you want to change **Copies, Pages, Resolution, Paper Source** and **Media Type**, select your settings before clicking **Print**.

By clicking the **option** button you can select various layout options such as pages per sheet.

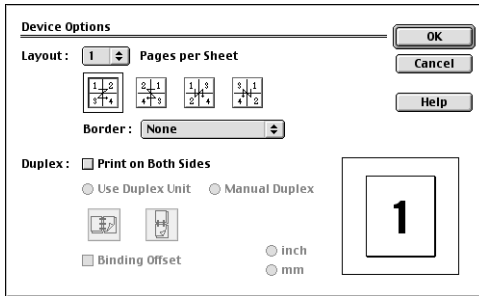

Using the Brother Printer Driver with Your Apple® Macintosh® (Mac OS® X)

Choosing page setup options

- 1 From application software such as Presto!® PageManager®, click the **File** menu and select **Page Setup**. Make sure *MFC-8220* is selected in the **Format for** pop-up menu. You can change the settings for **Paper Size**, **Orientation** and **Scaling**, then click **OK**.

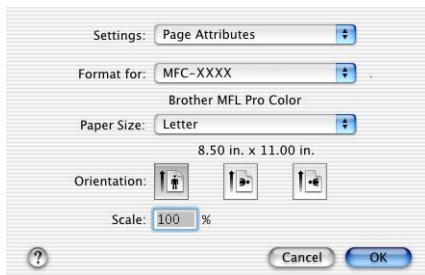

- 2 From application software such as Presto!® PageManager®, click the **File** menu and select **Print**. Click **Print** to start printing.

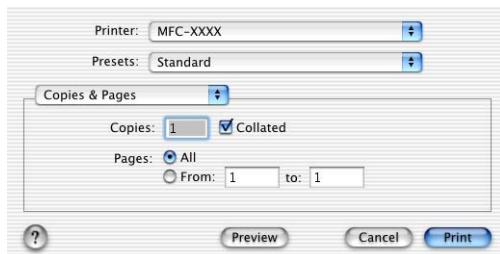

Specific settings

You can set the **Media Type**, **Resolution**, **Toner Save**, and other settings.

Press **Copies & Pages** dropdown to select settings you want to change.

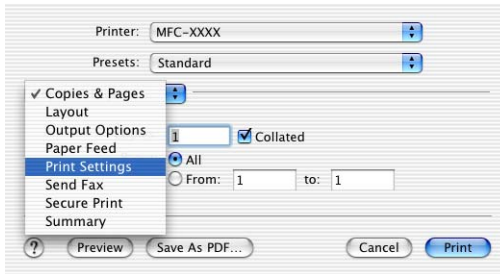

Printer settings

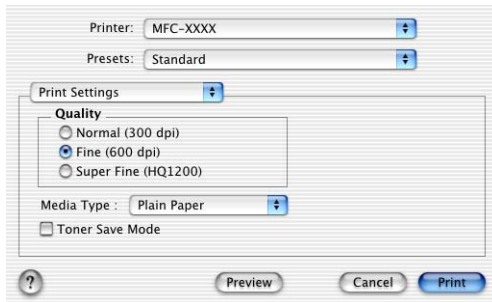

Layout

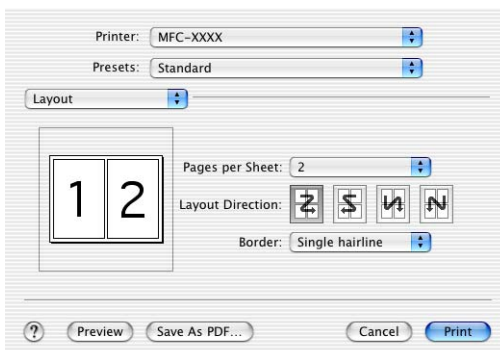

Using the PS driver with your Apple® Macintosh®



To use the PS driver on a Network, see the NC-9100h Network User's Guide on CD-ROM.



To use the PS driver with a USB cable, you need to set the Emulation to BR-Script 3 (**Menu, 4, 1**) before connecting the USB cable. (See *Setting the Emulation Selection* on page 1-12.)



The PS driver does not support the following functions:

- HQ 1200
- Secure Print
- PC-Fax Sending

For Mac OS® 8.6 to 9.2 users

1 For Mac OS® 8.6 to 9.04 Users:

Open the **Apple Extras** folder. Open the **Apple LaserWriter Software** folder.

For Mac OS® 9.1 to 9.2 Users:

Open the **Applications (Mac OS® 9)** folder. Open the **Utilities** folder*.

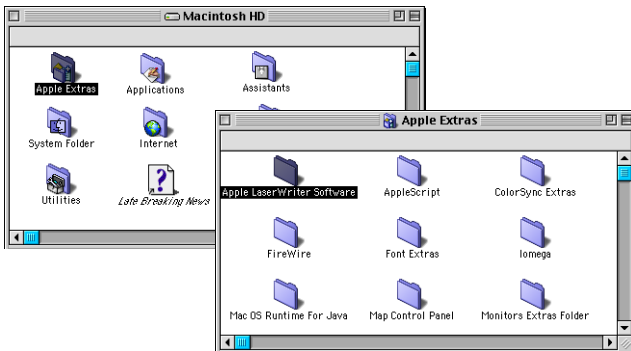

* The screens are based on Mac OS® 9.04.

2 Open the **Desktop Printer Utility** icon.

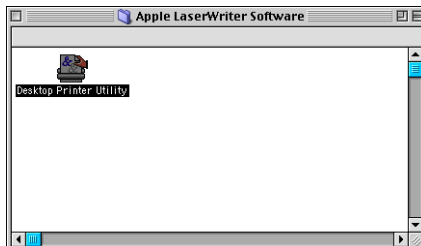

- 3 Select **Printer (USB)**, and then click **OK**.

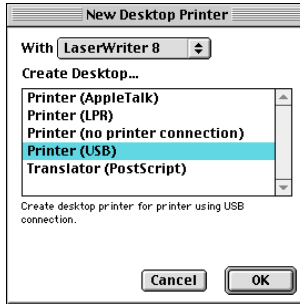

- 4 Click **Change...** in the PostScript™ Printer Description (PPD) file.

Select **Brother MFC-8220**, and then click **Select**.

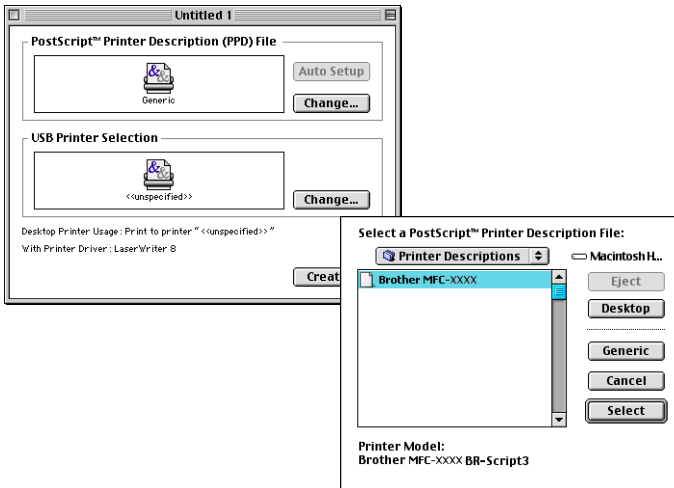

- 5 Click **Change...** in the **USB Printer Selection**.
Select **Brother MFC-8220**, and then click **OK**.

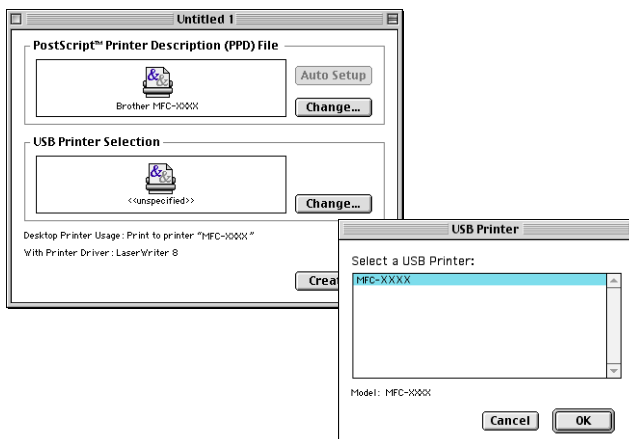

- 6 Click **Create...**

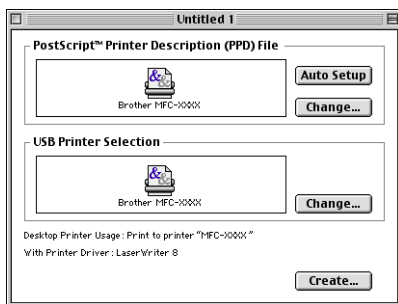

7 Enter your MFC name (MFC-8220), and then click **Save**.

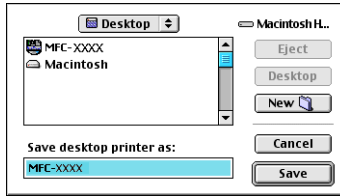

8 Select **Quit** from the **File** menu.

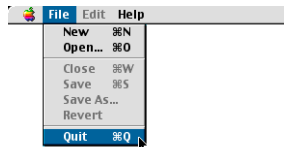
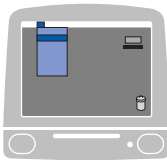

9 Click the **MFC-8220** icon on the Desktop.

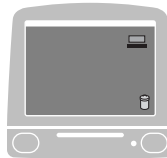

10 Select **Set Default Printer** from the **Printing** menu.

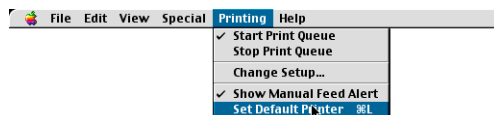
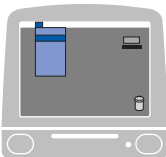

For Mac OS® X users

You need to install the PS driver using the following instructions.

- If you use a USB cable and your Macintosh® is “Mac OS® X”, only one printer driver for an MFC can be registered in Print Center.
- If a Brother Native Driver (MFC-XXX) is already listed in Printer list, you will need to delete it and then install the PS driver.
- To use the PS driver with a USB cable, you need to set the Emulation to BR-Script 3 (**Menu, 4, 1**) before connecting the USB cable. (See *Setting the Emulation Selection* on page 1-12.)

1 Select **Applications** from the **Go** menu.

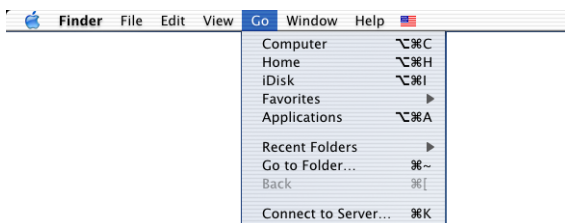

2 Open the **Utilities** folder.

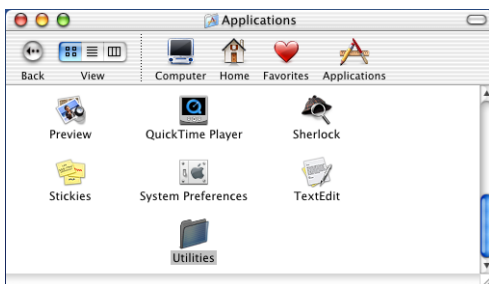

3 Open the **Print Center** icon.

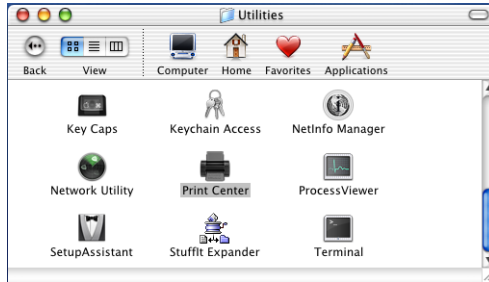

4 Click **Add Printer....**

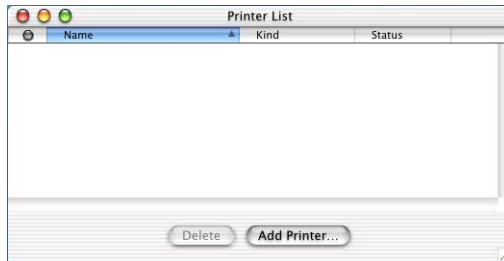

5 Select **USB**.

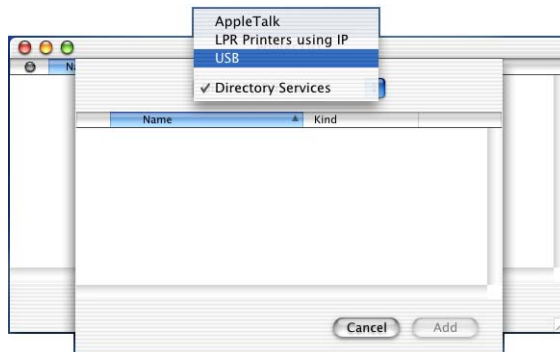

6 Select **MFC-8220**, and then click **Add**.

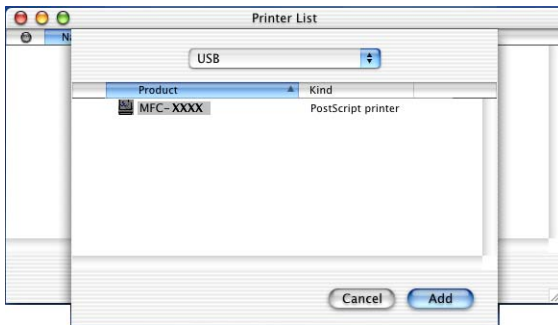

7 Select **Quit Printer Center** from the **Print Center** menu.

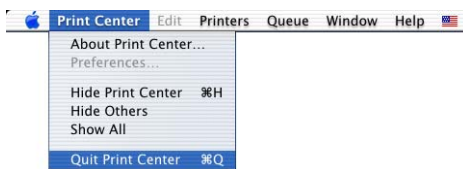
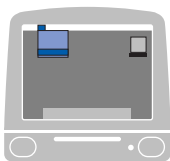

Sending a fax from your Macintosh[®] application

For Mac OS[®] 8.6-9.2 users

You can send a fax directly from a Macintosh[®] application by doing the following:

- 1 Create an original document in a Macintosh[®] application.
- 2 To send a fax, select **Print** from the **File** menu.

The Printer dialog box will appear:

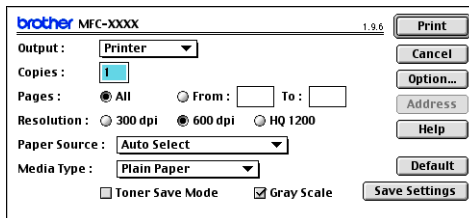

When *Printer* is selected, the top button shows **Print** and the **Address** button is grayed.

- 3 From the **Output** pull-down menu, select *Facsimile*.

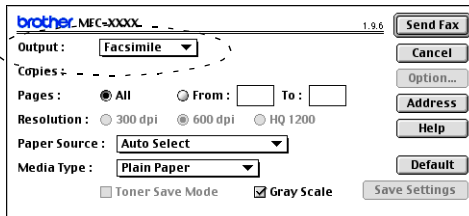

When *Facsimile* is selected, the top button changes to **Send Fax** and the **Address** button will be available.

4 Click **Send Fax**.

The **Send Fax** dialog box appears:

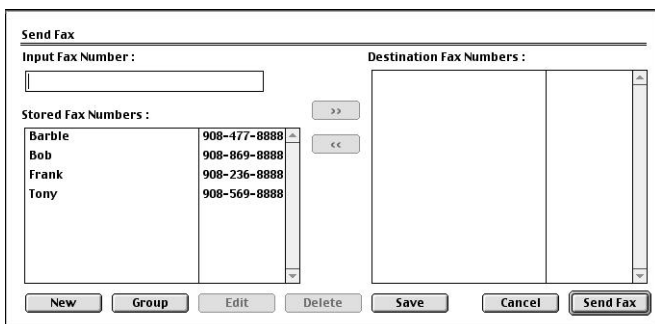

The **Send Fax** dialog box has two list boxes. The left box shows all the previously **Stored Fax Numbers** and the right box shows the **Destination Fax Numbers** as you select them.

5 To address the fax, type a fax number in the **Input Fax Number** box.

6 When you are finished addressing your fax, click **Send Fax**.

 To select and only send certain pages of the original documents, click **OK** to go to the Print dialog box.

 If you click **Send Fax** without addressing your fax, the following error message will appear:

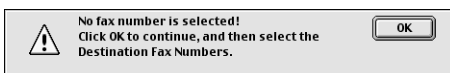

Click **OK** to go to the **Send Fax** dialog box.

For Mac OS® X users

You can send a fax directly from a Macintosh® application by doing the following:

- 1 Create an original document in a Macintosh® application.
- 2 To send a fax, select **Print** from the **File** menu.

The Printer dialog box will appear:

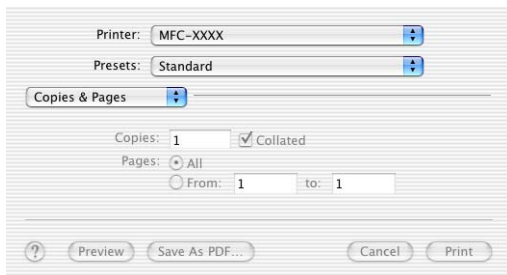

- 3 Select **Send Fax** from the pull-down menu.

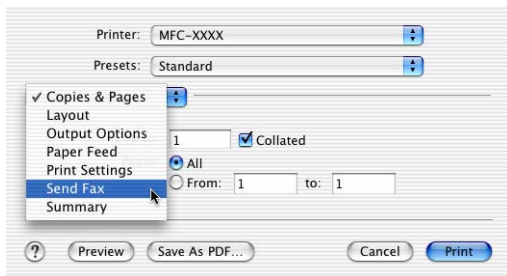

4 Select **Facsimile** from the **Output** pull-down menu.

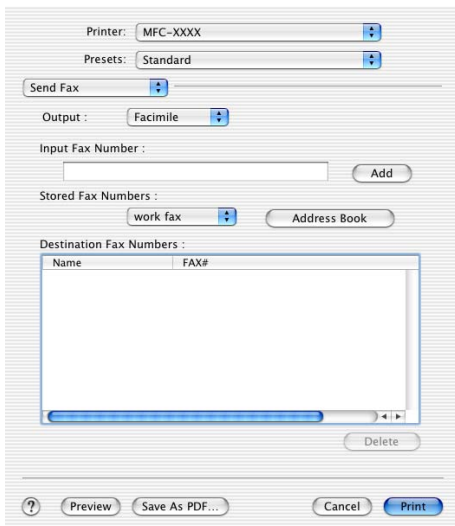

5 To address the fax, type a fax number in the **Input Fax Numbers** box, and then click **Print**.



If you want to send a fax to more than one number, click **Add** after entering the first fax number. The destination fax numbers will be listed in the dialog box.

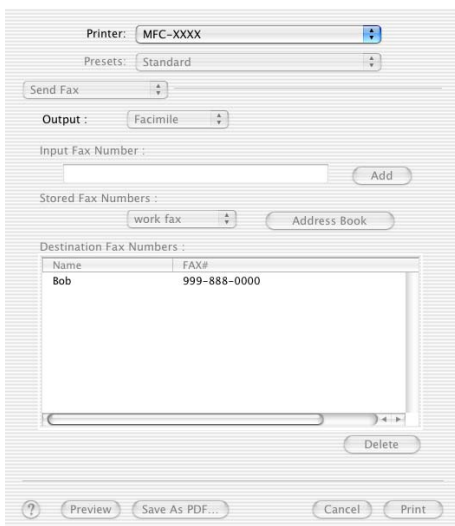

Drag a vCard from the Mac OS® X Address Book application

- 1 Click **Address Book** button.
- 2 Drag a vCard from the Mac OS® X **Address Book** application to the **Destination Fax Numbers** field.

When you are finished addressing your fax, click **Print**.

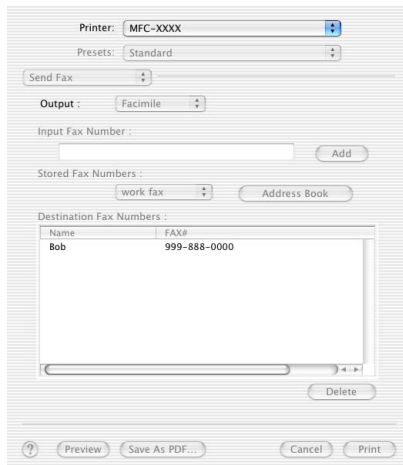
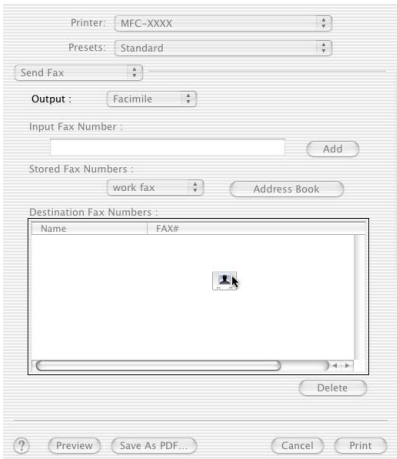



The vCard used must contain a **work fax** or **home fax** number.



When you choose **work fax** or **home fax** from the **Stored Fax Numbers** pull-down list, only the fax number stored in the Mac OS® X Address Book for the selected category will be used. If the fax number is stored in only one of the Mac OS® X Address Book categories, the number will be retrieved no matter which category you have selected (work or home).

Using the Brother TWAIN scanner driver with your Macintosh®

The Brother MFC software includes a TWAIN Scanner driver for Macintosh®. You can use this Macintosh® TWAIN Scanner driver with any applications that support the TWAIN specifications.

 Mac OS® X Scanning is supported in Mac OS® X 10.2.1-10.3 or greater.

Accessing the scanner

Run your Macintosh® TWAIN-compliant application software. The first time you use the Brother TWAIN driver set it as the default by choosing **Select Source** (or the other menu name to select the device). Afterwards, for each original document you scan choose **Acquire Image** or **Scan**. The scanner setup dialog box will appear.

 The screen shown in this section are from Mac OS® 9. The screen on your Macintosh® may vary depending on your Operating System.

 The method of selecting the source or choosing to scan may vary depending on the application software you are using.

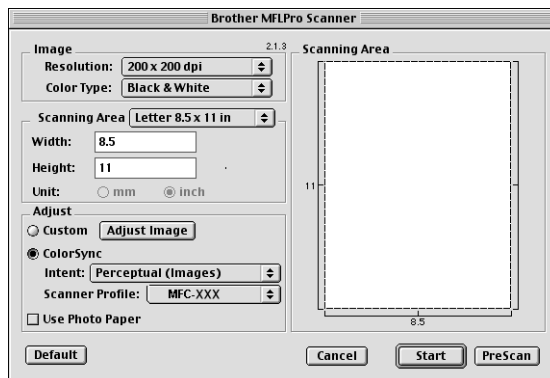

(Mac OS® 8.6–9.2)

Scanning an image into your Macintosh®

You can scan a whole page

—OR—

scan a portion after pre-scanning the original document.

Scanning a whole page

- 1 Place the original document face down in the ADF.
- 2 Adjust the following settings, if needed, in the Scanner Setup dialog box:

Resolution

Color Type

Scanning Area

Brightness

Contrast

- 3 Click **Start**.

When scanning has finished, the image will appear in your graphics application.

Pre-Scanning an image

Pre-Scanning allows you to scan an image quickly at a low resolution. A thumbnail version will appear in the **Scanning Area**. This is only a preview of the image, so you can see how it will look. The **PreScan** button will allow you to crop unwanted areas from the images. When you are satisfied with the preview, click **Start** to scan the image.

1 Place the original document face down in the ADF.

2 Click **PreScan**.

The whole image will be scanned into your Macintosh® and will appear in the **Scanning Area** of the Scanner dialog box:

3 To scan a portion of the prescanned image, click and drag the mouse to crop it.

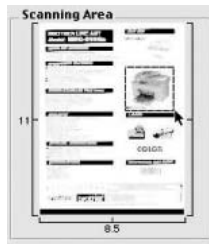

4 Place original document in the ADF again.

5 Make your adjustments to the settings for **Resolution**, **Color Type** (Gray Scale), **Brightness**, **Contrast**, and **Size** in the Scanner Setup dialog box.

6 Click **Start**.

This time only the cropped area of the original document will appear in the Scanning Area.

7 In your editing software, you can refine the image.

Settings in the Scanner window

Image

Resolution

From the **Resolution** pop-up menu choose the scanning resolution. Higher resolutions use more memory and transfer time, but produce a finer scanned image.

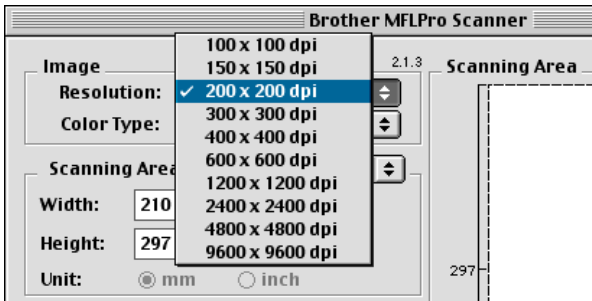

Color Type

Black & White—Set the image type to *Black and White* for text or line art. For photographic images, set the image type to Gray (Error diffusion) or True Gray.

Gray (Error Diffusion)—is used for original documents with photographic images or graphics. (Error Diffusion is a method for creating simulated gray images by placing black dots instead of the true gray dots in a specific matrix instead of true gray dots.)

True Gray—is used for original documents with photographic images or graphics. This mode is more exact because it uses up to 256 shades of gray. It requires the most memory and takes the longest transfer time.

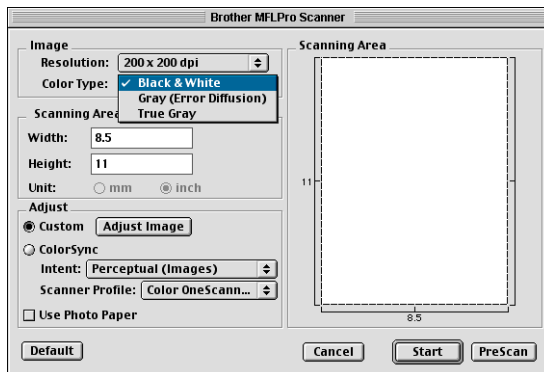

Scanning Area

Set the **Size** to one of the following:

- *Letter (8.5 × 11 inches)*
- *A4 (210 × 297 mm)*
- *Legal (8 1/2 × 14 in.)*
- *A5 (148 × 210 mm)*
- *B5 (182 × 257 mm)*
- *Executive (7.25 × 10.5 inches)*
- *Custom (user adjustable it from 0.35 × 0.35 in. to 8.5 × 11.69 in. or 8.9 × 8.9 mm to 216 × 356 mm)*

After you choose a custom size, you can adjust the scanning area. Click and hold the mouse button as you drag the mouse to crop the image.

Width: Enter the width of the custom size.

Height: Enter the height of the custom size.

When you are scanning photographs or other images to use in a word processor or other graphics application, it is a good idea to try different settings for the Contrast, Mode and Resolution to determine which settings look the best.

Adjusting the Image

Brightness

Adjust the **Brightness** setting to get the best image. The Brother TWAIN Scanner driver offers 100 Brightness levels (-50 to 50). The default value is 0, representing an 'average' setting.

You can set the **Brightness** level by dragging the slide bar to the right to lighten the image or to the left to darken the image. You can also type a value in the box to set the level. Click **OK**.

If the scanned image is too light, set a lower Brightness level and scan the image again.

If the image is too dark, set a higher Brightness level and scan the image again.

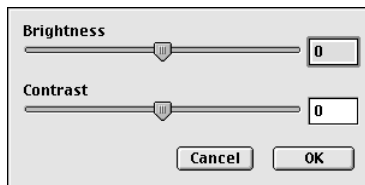

Contrast

You can only adjust the **Contrast** level when you have selected one of the Gray Scale settings, it is not available when you have selected Black & White as the selected **Color Type**.

Increasing the **Contrast** level (by dragging the slide bar to the right) emphasizes dark and light areas of the image, while reducing the **Contrast** level (by dragging the slide bar to the left) reveals more detail in the gray areas. Instead of using the slide bar, you can type a value in the box to set the Contrast. Click **OK**.

Using Presto!® PageManager®

Presto!® PageManager® is application software for managing the original documents in your computer. Since it is compatible with most image editors and word processing programs, Presto!® PageManager® gives you unmatched control over your computer files. You can easily manage your original documents, edit your E-mail files and read original documents with the OCR software built into Presto!® PageManager®.

If you use the MFC as a scanner, we recommend that you install Presto!® PageManager®. To install Presto!® PageManager®, see Quick Setup Guide on pages 46 to 53.



For more information, see online help for the NewSoft Presto!® PageManager® 4.0.

Highlights

- **OCR:** Scan an image, recognize the text, and edit it with a word processor.
- **Scan Buttons:** In one step scan original documents and open them with a designated program.
- **Image Editing:** Enhance, crop and rotate images, or open them with an image-editing program of your choice.
- **Annotation:** Add removable notes, stamps, and drawings to images.
- **Treeview Window:** View and arrange your folder hierarchy for easy access.
- **Thumbnail Window:** View files as thumbnails for easy identification.

System requirements

- PowerPC processor
- System 8.6, 9, X, 10.1, or greater
- CD-ROM drive
- Hard disk drive with at least 120 MB of free disk space

Recommended:

- 256 color or higher video adapter.
- Eudora Mail, or Outlook Express electronic mail software

Technical Support

For USA

Company name: Newsoft America Inc.
Postal Address: 4113 Clipper Court Fremont
CA 94538, USA
Telephone: 510-4458600
Fax: 510-4458601
E-mail Address: contactus@newsoftinc.com
URL: <http://www.newsoftinc.com/>

For Canada

E-mail Address: contactus@newsoftinc.com

MFC Remote Setup (Mac OS® X)

The MFC Remote Setup application enables you to configure your MFC using an intuitive graphical user interface (GUI) on your PC. When you access this application, the settings on your MFC will be downloaded automatically to your Macintosh® and displayed on your computer screen. If you change the settings, you can upload them directly to the MFC.



The 'MFC Remote Setup' application icon is in Macintosh HD/Library/Printers/Brother/Utility.

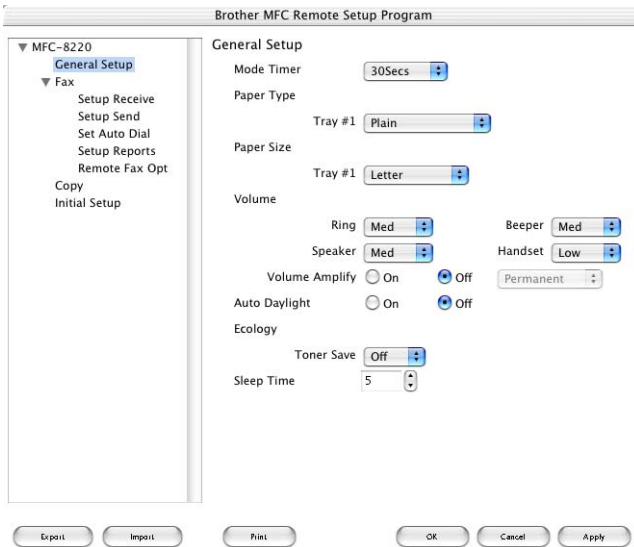

OK

This starts the process of uploading the data to the MFC and exiting the remote setup program. If an error message is displayed enter the correct data again. Click **OK**.

Cancel

This exits the remote setup application without uploading the data to the MFC.

Apply

This uploads the data to the MFC, but does not exit the remote setup application.

Print

This command prints the selected items on the MFC. You can not print the data until it is uploaded to the MFC. Click **Apply** to upload the new data to the MFC and click **Print**.

Export

This command saves the current configuration settings to a file.

Import

This command reads the settings from a file.

9

Network Scanning

(Windows® 98/98SE/Me/2000 Professional and XP only)

To use the MFC as a Network Scanner, the optional NC-9100h Network board must be installed into the MFC and configured with TCP/IP and mail server settings if you use Scan to E-mail (E-mail server). You can set or change NC-9100h settings from the control panel or with the BRAdmin Professional utility or Web Management. (Please see the NC-9100h User's Guide on the CD-ROM.)

Network License

This product includes a single PC license. If you purchase an optional Network LAN board NC-9100h that includes the license for up to 4 additional Users, you can install the MFL-Pro Software Suite including ScanSoft® PaperPort® on up to 5 PC's for use on a network. If you want to use more than 5 PCs with ScanSoft® PaperPort® installed, please purchase NL-5 which is a multiple PC license agreement pack for up to an additional 5 Users. To purchase NL-5, please contact your Brother Sales Office.

Registering your PC with the MFC

If you need to change the MFC that was registered to your PC during the installation of Brother MFL-Pro Suite (see Quick Setup Guide on page 43), follow the steps below.

1 For Windows® 98/Me/2000

From the **Start** menu, select **Control Panel, Scanners and Cameras**, and then right-click Scanner Device icon and select **Properties** to view the Network Scanner Properties dialog box.

For Windows® XP

From the **Start** menu, select **Control panel, Printers and Other Hardware, Scanners and Cameras** (or **Control Panel, Scanners and Cameras**).

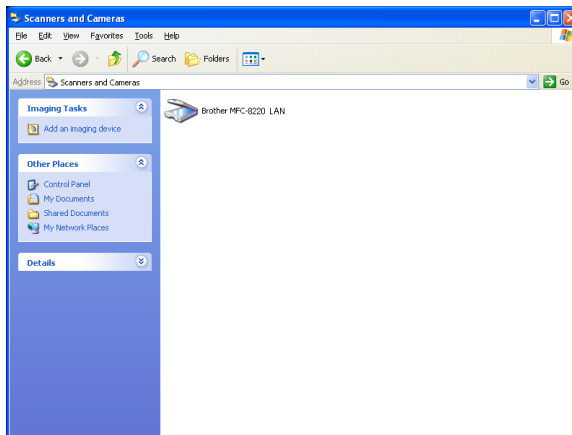

Right-click Scanner Device icon and select Properties to view the Network Scanner Properties dialog box.

- 2 Click the **Network Setting** tab in the dialog box and select a method to specify the MFC as a Network scanner for your PC.

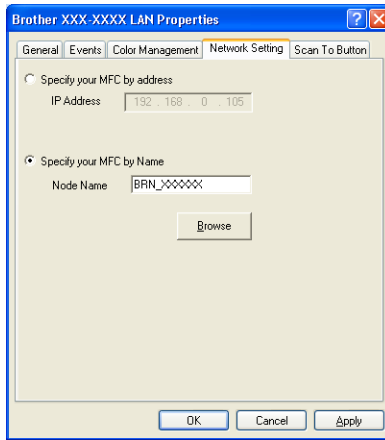

Specify your MFC by address

Enter the actual IP address of the MFC in the IP Address field.

Click **Apply** and then **OK**.

Specify your MFC by Name

Enter the MFC Node name in the Node Name field.

Click **Apply** and then **OK**.

Search from a list of available device

Click **Browse** and select the appropriate device you want to use.

Click **OK**.

Click **Apply** and then **OK**.

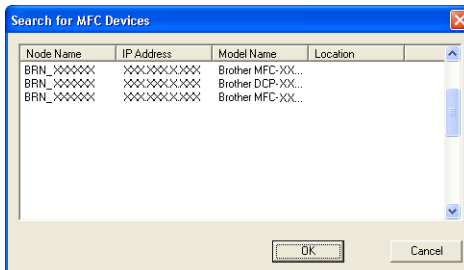

- 3 Click the **Scan To Button** tab in the dialog box and enter your PC Name in the Display Name field. The MFC's LCD displays the Name you enter. Default setting is your PC Name. You can enter a name if you like.

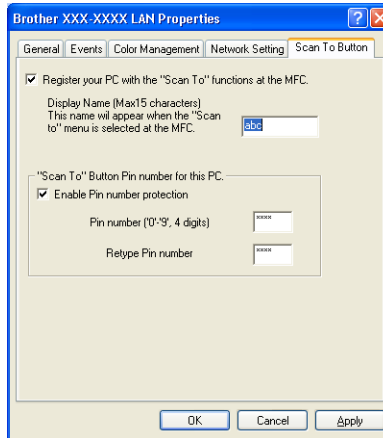



- 4 You can avoid receiving unwanted original documents by setting a 4-digit PIN Number. Enter your PIN Number in the PIN Number and Retype PIN Number field. To send data to a PC protected by a PIN Number, the LCD prompts you to enter the PIN Number before the original document can be scanned and sent to the MFC. (See *Using the Scan key* on page 9-5 to 9-9.)

Using the Scan key

Scan to E-mail (PC)



When you select **Scan to E-mail (PC)** your original document will be scanned and sent directly to the PC you designated on your network. The Brother SmartUI will activate the default E-mail application on the designated PC for addressing to the recipient. You can scan a black and white original document and it will be sent with the E-mail from the PC as an attachment.

 For Network Scanning the Brother Control Center (SmartUI) selections are used only for configuring the **Scan** button. You will not be able to initiate a Network scan from the Brother Control Center (SmartUI).

You can change the  (**Scan**) configuration. For Windows® 98/98SE/Me/2000: (See *Scan to E-mail* on page 4-10 to 4-12.) (For Windows® XP: See *Hardware Section: Changing the Scan to button configuration* on page 5-5 to 5-9.)

1 Place the original document face down in the ADF.

2 Press  (**Scan**).

3 Press  or  to select **Scan to E-mail**.

Scan to E-mail
PC



Press **Set**.

4 Press  or  to select **PC**.

Press **Set**.

—OR—

If there is no other selection, go to Step 5.

5 Press  or  to select the destination PC you want to use for E-mailing your original documents.

Press **Set**.

If the LCD prompts you to enter a PIN Number, enter the 4-digit PIN Number for the destination PC on the control panel.

Press **Set**.

The MFC will start the scanning process.



Scan to E-mail (E-mail server)

When you select Scan to E-mail (E-mail server) you can scan a black and white original document and send it directly to an E-mail address from the MFC. Your original document is sent as an E-mail attachment in a TIFF or PDF format.

 Scan to E-mail (E-mail Server) requires SMTP/POP3 mail server support. (See NC-9100h User's Guide on the CD-ROM.)

1 Place the original document face down in the ADF.

2 Press  (**Scan**).

3 Press  or  to select Scan to E-mail.
Press **Set**.



4 Press  or  to select E-mail Server.

Scan to E-mail E-mail Server ▾

Press **Set**.

—OR—

If there is no other selection, go to Step 5.

5 Press  or  to select PDF 200×200dpi, PDF 200×100dpi, TIFF 200×200dpi or TIFF 200×100dpi and **Set**.

6 The LCD prompts you to enter an address. Enter the destination E-mail address from the dial pad or use the One-Touch key or Speed-Dial key.

7 Press **Start**.

The MFC will start the scanning process.

Scan to Image

When you select *Scan to Image* your original document will be scanned and sent directly to the PC you designated on your network. The Brother SmartUI will activate the default graphics application on the designated PC. You can change the **Scan** configuration. (For Windows® 98/Me/2000: See *Scan to Image* on page 4-16 to 4-17.) (For Windows® XP: See *Hardware Section: Changing the Scan to button configuration* on page 5-5 to 5-11.)



For Network Scanning the Brother Control Center (SmartUI) selections are used only for configuring the **Scan** button. You will not be able to initiate a network scan from the Brother Control Center (SmartUI).



1 Place the original document face down in the ADF.

2 Press  (**Scan**).

3 Press  or  to select *Scan to Image*.

Select ▲▼ & Set
Scan to Image ◆

Press **Set**.

4 Press  or  to select a destination you want to send.
Press **Set**.

If the LCD prompts you to enter a PIN Number, enter the 4-digit PIN Number for the destination PC on the control panel.

Press **Set**.

The MFC will start the scanning process.

Scan to OCR

When you select *Scan to OCR* your original document will be scanned and sent directly to the PC you designated on your network. The Brother SmartUI will activate ScanSoft® TextBridge® and convert your original document into text for viewing and editing from a word processing application on the designated PC. You can change the **Scan** configuration.

(For Windows® 98/Me/2000: See *Scan to OCR (Word Processor)* on page 4-13 to 4-15.) (For Windows® XP: See *Hardware Section: Changing the Scan to button configuration* on page 5-5 to 5-11.)



For Network Scanning the Brother Control Center (SmartUI) selections are used only for configuring the **Scan** button. You will not be able to initiate a network scan from the Brother Control Center (SmartUI).



1 Place the original document face down in the ADF.

2 Press  (**Scan**).

3 Press  or  to select *Scan to OCR*.

Select ▲▼ & Set
Scan to OCR ◆

Press **Set**.

4 Press  or  to select a destination you want to send.
Press **Set**.

If the LCD prompts you to enter a PIN Number, enter the 4-digit PIN Number for the destination PC on the control panel.

Press **Set**.

The MFC will start the scanning process.

Scan to File

When you select *Scan to File* you can scan a black and white original document and send it directly to a PC you designate on your network. The file will be saved in the folder and file format that you have configured in the Brother SmartUI on the designated PC. You can change the **Scan** configuration.

(For Windows® 98/Me/2000: See *Scan to File* on page 4-8 to 4-9.)

(For Windows® XP: See *Hardware Section: Changing the Scan to button configuration* on page 5-5 to 5-11.)



For Network Scanning the Brother Control Center (SmartUI) selections are used only for configuring the **Scan** button. You will not be able to initiate a network scan from the Brother Control Center (SmartUI).



1 Place the original document face down in the ADF.

2 Press  (**Scan**).

3 Press  or  to select *Scan to File*.

Select ▲▼ & Set
Scan to File ◆

Press **Set**.

4 Press  or  to select a destination you want to send.
Press **Set**.

If the LCD prompts you to enter a PIN Number, enter the 4-digit PIN Number for the destination PC on the control panel.

Press **Set**.

The MFC will start the scanning process.



Max. 25 clients can be connected to one MFC on a Network. For example, if 30 clients try to connect at a time, 5 clients will not be shown on the LCD.

10 Brother Network PC-FAX software

To use the MFC with Network PC-FAX, the optional NC-9100h Network board must be installed into the MFC and configured with a TCP/IP address. If you use PC-FAX to an E-mail address, the mail server settings must also be configured.

Enable Network PC-FAX

To use the MFC for Network PC-FAX, see *Using Brother PC-FAX software* on page 7-1.



The items described in this chapter are specific items relating to the Network version of PC-FAX software that is installed from the Network Applications for Optional NC-9100h on the CD-ROM supplied with your MFC.

Brother Network PC-FAX can be configured through PC-FAX Setup, Sending tab.

Sending setup

In order to use the full functionality of Network PC-FAX enable the Network PC-FAX Setup option on the Sending tab in Brother PC-FAX Setup.

- 1 Access the Sending Tab from the PC-FAX dialog box by clicking .

—OR—

From the **Start** menu, select **All programs, Brother, MFL-Pro Suite MFC-8220**, and then select **PC-FAX Setup**.

- 2 Check **Enable** box.

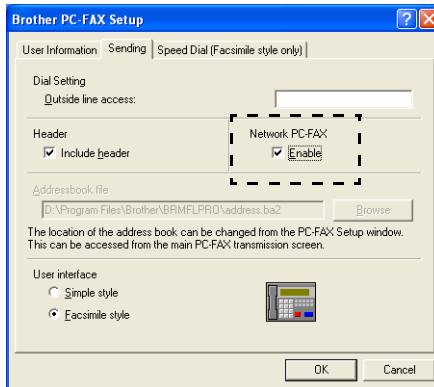

This software can be used in a network environment and with a locally connected machine. It is important that when used in a network environment the Network PC Fax is set to enable.

Extra options in Address Book

When the Enable Network PC-FAX option is selected, three additional options appear in the address book contact window.

- 1 In the Address Book dialog box, click the  icon to add a member.

The **Brother Address Book Member Setup** dialog box will appear:

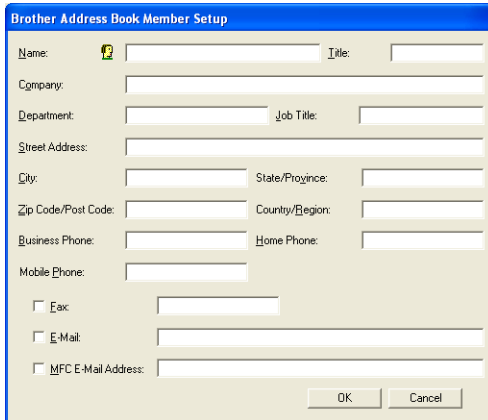

Brother Address Book Member Setup

Name:  _____ Title: _____

Company: _____

Department: _____ Job Title: _____

Street Address: _____

City: _____ State/Province: _____

Zip Code/Post Code: _____ Country/Region: _____

Business Phone: _____ Home Phone: _____

Mobile Phone: _____

Fax: _____

E-Mail: _____

MFC E-Mail Address: _____

OK Cancel

- 2 In the **Brother Address Book Member Setup** dialog box, type the member's information.

Name is required field. You can also enter an E-mail contact address and MFC address for the address book member.

- 3 It is necessary to specify the preferred method of sending original documents to this contact by checking the **Fax**, **E-mail** or **MFC E-mail Address** box.

- 4 Click the **OK** button to save the member's information.



If you wish to send original documents to this contact by more than one method you must create a second contact and select a different option, Fax, E-Mail or MFC Address.

Using the Brother Network PC-FAX software

The Brother Network PC-FAX feature allows you to use your PC to send any application or document file as a standard fax. You can create a file in any application on your PC, and then send it as a Network PC-FAX. You can even attach a cover page note. All you have to do is set up the receiving parties as Members or Groups in your PC-FAX Address Book or simply enter the destination address or fax number into the User Interface. You can use the Address Book Search feature to quickly find members to send your fax.



Please check Brother Solutions Center for the latest updates available for Brother Network PC-FAX. Visit <http://solutions.brother.com/>

Quick Tips:

Please see *Enable Network PC-FAX* on page 10-1 before using Brother Network PC-FAX.

- 1 Ensure that Network PC-FAX is set to “Enable” in the Sending tab of Setup. (See *Enable Network PC-FAX* on page 10-1.)

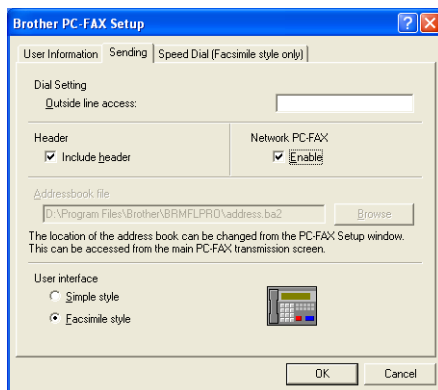

- 2 To send an E-mail from Brother Network PC-FAX you can either enter the E-mail address in the To: field or in the display for Facsimile Style using the PC keyboard or select the member from the Address Book. The member must have E-mail selected as the chosen destination for that member.
- 3 To send an Internet Fax from Brother Network PC-FAX you can either enter the Internet Fax address in the To: field or in the display for Facsimile style using the PC keyboard or select the member from the Address Book. The member must have MFC Mail Address selected as the chosen destination for that member.
- 4 To send a Network Fax simply select a member from the address book or enter the fax number into the User Interface with the PC keyboard. The member must have Fax selected as the chosen destination for that member.



Sending a Network PC-Fax to an E-mail address or sending an Internet Fax requires SMTP/POP3 mail server support.

Sending a Network PC-FAX from your Macintosh® application

You can send a fax directly from your Macintosh® application using the following steps:

For Mac OS® 8.6-9.2 users

- 1 Follow the steps on pages 50 and 51 in the Quick Setup Guide.
- 2 Follow the steps on pages 8-14 and 8-15.

For Mac OS® X 10.1/10.2.1-10.3 or greater users

- 1 Follow the steps on pages 52 and 53 in the Quick Setup Guide.
- 2 Follow the steps on pages 8-16 to 8-19.

Index

- A**
 - Address book
 - PC-FAX (Macintosh®) 8-18
 - PC-FAX (Network) 10-3
 - PC-FAX (Windows®)
..... 7-7, 7-8, 7-10, 7-12
 - Attachments
 - combining files 4-12
- B**
 - Brightness 3-7, 8-26
 - Broadcasting 7-9
 - Brother Control Center, using
and configuring
Windows® 4-1
- C**
 - Contrast 3-7, 8-26
- D**
 - Drivers
 - Macintosh®
 - Brother TWAIN 8-20
 - printer 8-2, 8-4
 - PS 8-6
 - Windows®
 - printer 1-1, 2-1
 - PS 2-20
 - TWAIN 3-1
 - WIA 3-10
 - Duplex Printing 1-2, 2-8
- E**
 - Emulation
 - Macintosh® 8-6
 - Windows® 1-1, 1-12, 2-20
 - Envelopes 1-7
 - Export
 - Address book 7-10
 - Files 3-22
- I**
 - Import
 - Address book 7-12
 - Files 3-22
- M**
 - Manual feed tray 1-4, 1-5
 - MFL-Pro 4-1
- N**
 - Native Driver
 - Windows® 2-2
 - Network 9-1, 10-1
- O**
 - OCR 5-10
 - OCR, changing settings 5-11
- P**
 - Paper
 - driver settings
..... 2-2, 2-23, 2-24
 - How to load 1-4
 - PaperPort®
 - accessing 3-2
 - PaperPort® (Windows®)
and TextBridge® OCR 3-17
 - exporting 3-22
 - importing 3-22
 - PC-FAX (for Network) 10-1
 - PC-FAX (for Windows®) 7-1
 - receiving 7-19

- sending
 - address book 7-7
 - cover page 7-14
 - facsimile style 7-16
 - Group 7-9
 - setting up 7-14
 - simple style 7-17
 - Print
 - driver 2-1
 - Emulation
 - Macintosh® 8-6
 - Windows® 1-1, 1-12, 2-20
 - envelopes 1-7
 - manual feed tray 1-4
 - reports and lists 1-13
 - Secure key 1-10
 - thick paper 1-5
 - Windows®
 - driver settings 2-1
 - keys on control panel ... 1-10
 - PS printer driver 2-20
- R**
- Resolution
 - scanning
 - Macintosh®
 - 8-5, 8-21, 8-22, 8-23
 - PC-FAX 4-21
 - Windows®
 - 2-7, 3-3, 3-6, 3-12, 4-6
- S**
- Scan
 - changing default settings ... 5-9
 - Macintosh® 8-20
 - Windows®
 - into PC 3-3
 - Resolution 3-6
 - ScanSoft® PaperPort®
 - 3-17, 3-21
 - TWAIN Compliant 3-1
 - using Scan key 3-14
 - WIA Compliant 3-10
 - XP only 3-10
 - Scan to E-mail
 - Brother Control Center
 - 4-4, 4-10, 5-6, 5-13, 5-17
 - using Scan key
 - 3-14, 3-15, 9-5, 9-6
 - Scan to File
 - Brother Control Center
 - 4-4, 4-8, 5-3, 5-7, 5-13, 5-14, 5-15
 - using Scan key
 - 3-14, 3-16, 9-9
 - Scan to Image
 - Brother Control Center
 - 4-4, 4-16, 5-8
 - using Scan key
 - 3-14, 3-15, 9-7
 - Scan to OCR
 - Brother Control Center
 - 4-4, 4-13, 5-10, 5-21
 - using Scan key
 - 3-14, 3-16, 9-8
 - Scanning into PC 3-3
 - Software
 - Macintosh®
 - MFC Remote Setup
 - (Mac OS® X) 8-29
 - Presto!® PageManager®
 - 8-27
 - Speed-Dial 7-6



Brother International Corporation
100 Somerset Corporate Boulevard
P.O. Box 6911
Bridgewater, NJ 08807-0911 USA

Brother International Corporation (Canada) Ltd.
1 rue Hôtel de Ville,
Dollard-des-Ormeaux, QC, CANADA H9B 3H6

**Visit us on the World Wide Web
<http://www.brother.com>**

These machines are made for use in the USA and CANADA only. We cannot recommend using them overseas because it may violate the Telecommunications Regulations of that country and the power requirements of your multi-function center may not be compatible with the power available in foreign countries. **Using USA or CANADA models overseas is at your own risk and may void your warranty.**

Version A

Free Manuals Download Website

<http://myh66.com>

<http://usermanuals.us>

<http://www.somanuals.com>

<http://www.4manuals.cc>

<http://www.manual-lib.com>

<http://www.404manual.com>

<http://www.luxmanual.com>

<http://aubethermostatmanual.com>

Golf course search by state

<http://golfingnear.com>

Email search by domain

<http://emailbydomain.com>

Auto manuals search

<http://auto.somanuals.com>

TV manuals search

<http://tv.somanuals.com>