

brother®

USER'S GUIDE

DCP-115C

DCP-116C

DCP-120C

DCP-315CN

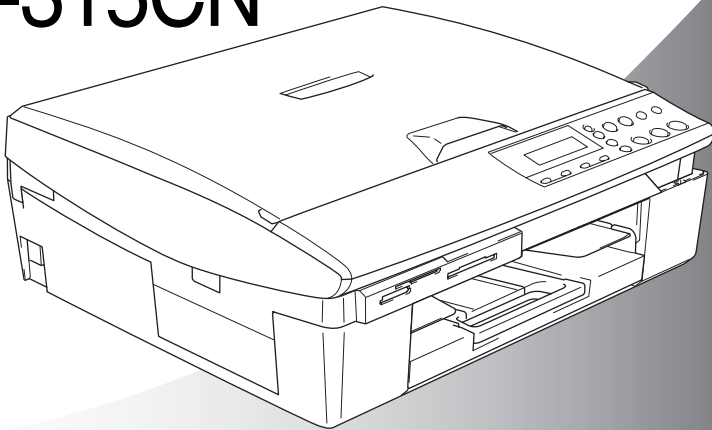

brother®

If you need to call Customer Service

Please complete the following information for future reference:

Model Number: DCP-115C, DCP-116C, DCP-120C and DCP-315CN (Circle your model number)

Serial Number:* _____

Date of Purchase: _____

Place of Purchase: _____

*** The serial number is on the back of the unit. Retain this User's Guide with your sales receipt as a permanent record of your purchase, in the event of theft, fire or warranty service.**

Register your product on-line at

<http://www.brother.com/registration/>

By registering your product with Brother, you will be recorded as the original owner of the product.

Compilation and Publication Notice

Under the supervision of Brother Industries Ltd., this manual has been compiled and published, covering the latest product descriptions and specifications.

The contents of this manual and the specifications of this product are subject to change without notice.







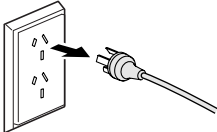

Brother reserves the right to make changes without notice in the specifications and materials contained herein and shall not be responsible for any damages (including consequential) caused by reliance on the materials presented, including but not limited to typographical and other errors relating to the publication.

Safety precautions

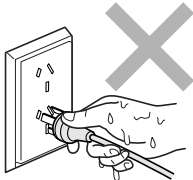
To use the machine safely

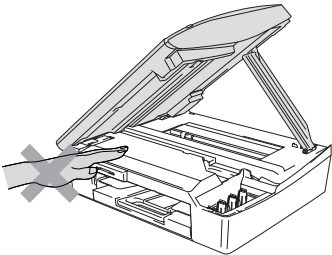
Please refer to these instructions for later reference and before attempting any maintenance.

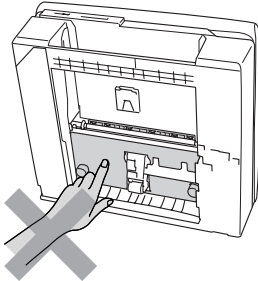
WARNING

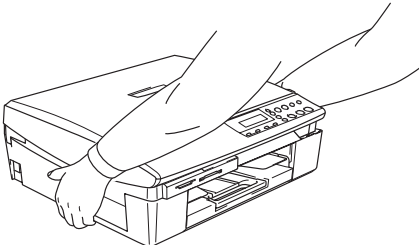
	<p>There are high voltage electrodes inside the machine. Before you clean the machine, make sure you have unplugged the power cord from the electrical socket.</p> 		<p>Do not handle the plug with wet hands. Doing this might cause an electrical shock.</p> 
	<p>To prevent injuries, be careful not to put your hands on the edge of the machine under the scanner cover.</p> 		<p>To prevent injuries, be careful not to touch the area shaded in the illustration.</p> 
	<p>When you move the machine, place a hand at each side of the unit so you are supporting the base when you lift it. (See the illustration on the right.) Do not carry the machine by holding the scanner cover.</p> 		



Most of the illustrations in this User's Guide show the DCP-115C.

 **WARNING**

This product must be installed near an electrical socket that is easily accessible. In case of emergencies, you must disconnect the power cord from the electrical socket in order to shut off power completely.

 **Caution**

To maintain the best print quality, we recommend that you use the On/Off key to turn off your machine. Do not unplug the power cord from the electrical socket, unless moving the machine or performing maintenance. If you need to disconnect your machine from the power, you will need to set the date and time again. (See Quick Setup Guide.)

Choosing a location

Place your machine on a flat, stable surface that is free of vibration and shocks, such as a desk. Put the machine near a standard, grounded electrical socket. Select a location where the temperature remains between 10° and 35°C.

! Caution

- Avoid placing your machine in a high-traffic area.
- Avoid placing your machine on the carpet.
- Do not place near heaters, air conditioners, water, chemicals, or refrigerators.
- Do not expose the machine to direct sunlight, excessive heat, moisture, or dust.
- Do not connect your machine to electrical sockets controlled by wall switches or automatic timers.
- Disruption of power can wipe out information in the machine's memory.
- Do not connect your machine to electrical sockets on the same circuit as large appliances or other equipment that might disrupt the power supply.

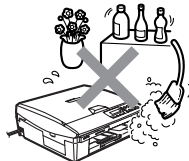
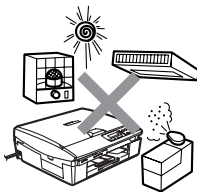

How to access the complete User's Guide

This User's Guide does not contain all the information about the machine such as how to use the advanced features of the Printer, Scanner and Network. When you are ready to learn detailed information about these operations, read the complete User's Guide located in the 'Documentation' section of the CD-ROM.



Network is available only for DCP-315CN.

To view Documentation (For Windows®)

From the **Start** menu, select **Brother, MFL Pro Suite DCP-XXXX** (where XXXX is your model name) from the Programs Group, and then select **User's Guide**.

—OR—

- 1 Turn on your PC. Insert the Brother CD-ROM labelled Windows® into your CD-ROM drive.
- 2 If the model name screen appears, click your model name.
- 3 If the language screen appears, click your language.

The CD-ROM main menu will appear.

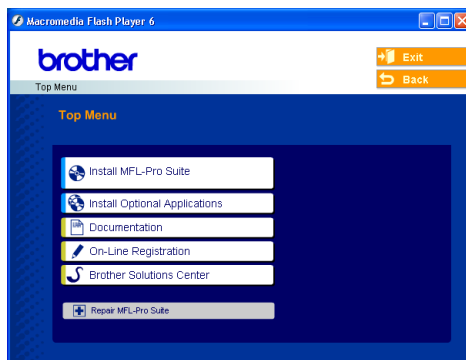

If this window does not appear, use Windows® Explorer to run the setup.exe program from the root directory of the Brother CD-ROM.

- 4 Click **Documentation**.

5 Click the documentation you want to read.

- **Quick Setup Guide:** Setup and Software Installation Instructions
- **User's Guide (3 manuals):** User's Guide for stand-alone operations, Software User's Guide and Network User's Guide (DCP-315CN only)
- **PaperPort® User's Guide:** Document Management Software

How to find Scanning instructions

There are several ways you can scan documents. You can find the instructions as follows:

Software User's Guide:

- Scanning on page 2-1
(For Windows® 98/98SE/Me/2000 Professional and Windows® XP)
- ControlCenter2 on page 3-1
(For Windows® 98/98SE/Me/2000 Professional and Windows® XP)
- Network Scanning (DCP-315CN only) on page 4-1

PaperPort® User's Guide

- Instructions for scanning directly from ScanSoft® PaperPort®

To view Documentation (For Macintosh®)

- 1 Turn on your Macintosh®. Insert the Brother CD-ROM labelled Macintosh® into your CD-ROM drive. The following window will appear.



- 2 Double-click the **Documentation** icon.
- 3 The select Language screen appears, double-click your language.
- 4 Click the documentation you want to read.
 - **Quick Setup Guide:** Setup and Software Installation Instructions
 - **User's Guide (3 manuals):** User's Guide for stand-alone operations, Software User's Guide and Network User's Guide (DCP-315 CN only)

How to find Scanning instructions

There are several ways you can scan documents. You can find the instructions as follows:

Software User's Guide:

- Scanning on page 9-1
(For Mac OS® 9.1-9.2/Mac OS® X 10.2.4 or greater)
- ControlCenter2 (For Mac OS® X 10.2.4 or greater) on page 10-1
- Network Scanning (DCP-315CN only) (For Mac OS® X 10.2.4 or greater) on page 11-1

Presto!® PageManager® User's Guide

- Instructions for scanning directly from Presto!® PageManager®

Table of Contents

1

Introduction	1-1
Using this Guide	1-1
Finding information	1-1
Symbols used in this Guide	1-1
Control panel overview	1-2
Warning LED indications	1-4
Load documents	1-5
Using the ADF (automatic document feeder) (DCP-120C only)	1-5
Using the scanner glass	1-7
About paper	1-8
Recommended Paper	1-8
Handling and using special paper	1-9
Paper type and size for each operation	1-10
Paper weight, thickness and capacity	1-11
Paper capacity of the output paper tray	1-11
Printable area	1-12
How to load paper, envelopes and post cards	1-13
To load paper or other media	1-13
To load envelopes	1-15
To load post cards	1-16

2

Making copies	2-1
Using the machine as a copier	2-1
Making a single copy	2-1
Making multiple copies	2-1
Stop copying	2-1
Using the Copy keys	2-2
Increasing copy speed or quality	2-3
Enlarging or reducing the image copied	2-4
Changing the temporary copy settings	2-6
Setting paper type	2-7
Setting paper size	2-7
Adjusting brightness	2-8
Sorting copies using the ADF (DCP-120C only)	2-8
Making N in 1 copies or a poster (Page Layout)	2-9
Changing the default copy settings	2-12
Setting Paper Type	2-12
Setting Paper Size	2-13
Increasing copy speed or quality	2-13
Adjusting brightness	2-14

Adjusting contrast	2-14
Adjusting Colour saturation	2-15
Legal limitations	2-16

3

Walk-Up PhotoCapture Center™	3-1
Introduction	3-1
PhotoCapture Center™ requirements	3-2
Getting started	3-3
Printing the Index (Thumbnails).....	3-5
Printing images	3-6
DPOF printing.....	3-8
Changing the default settings	3-9
Increasing print speed or quality.....	3-9
Setting paper and size.....	3-9
Adjusting brightness	3-10
Adjusting contrast.....	3-10
Colour enhancement	3-11
Cropping	3-12
Borderless	3-13
Scan to Card (DCP-115C, DCP-120C and DCP-315CN only).....	3-13
Changing the default quality	3-14
Changing the default black & white file format	3-15
Changing the default colour file format.....	3-15
Understanding the Error Messages	3-16
Using PhotoCapture Center™ from your computer.....	3-16

4

Software and Network features	4-1
--	------------

5

Important information	5-1
For your safety.....	5-1
LAN connection (DCP-315CN only)	5-1
International ENERGY STAR® Compliance Statement	5-1
Important safety instructions.....	5-2
Trademarks	5-4

6

Troubleshooting and routine maintenance	6-1
Troubleshooting.....	6-1
Error messages	6-1
Document jams (DCP-120C only)	6-3
Document is jammed in the top of the ADF unit.....	6-3
Document is jammed inside the ADF unit	6-3
Printer jam or paper jam	6-4

Paper is jammed inside the paper tray	6-4
Paper is jammed inside the machine.....	6-5
If you are having difficulty with your machine	6-7
How to change LCD language	6-10
How to improve the LCD viewing.....	6-10
Setting the Beeper Volume.....	6-10
How to improve print quality	6-11
Cleaning the print head.....	6-11
Checking the print quality	6-12
Checking the printing alignment	6-14
Checking the ink volume.....	6-15
Packing and shipping the machine	6-16
Routine maintenance.....	6-19
Cleaning the scanner.....	6-19
Cleaning the machine printer platen.....	6-20
Cleaning the Paper Pick-up Roller.....	6-21
Replacing the ink cartridges	6-22

A

Appendix	A-1
On-screen programming.....	A-1
Menu table.....	A-1
Printing reports	A-1
Menu keys	A-2

S

Specifications	S-1
Product description	S-1
General	S-1
Print media.....	S-2
Copy	S-3
PhotoCapture Center™	S-4
Scanner	S-5
Printer	S-6
Interfaces	S-6
Computer requirements	S-7
Consumable items.....	S-8
Network (LAN) (DCP-315CN only)	S-9

Index	I-1
--------------------	------------

1 Introduction

Using this Guide

Thank you for buying a Brother Digital Copier/Printer (DCP). Your machine is simple to use, with LCD screen instructions to guide you through programming it. You can make the most of your machine by reading through this Guide.





Finding information

All the chapter headings and subheadings are listed in the Table of Contents. You will be able to find information about a specific feature or operation by checking the Index at the back of this Guide.

Symbols used in this Guide

Throughout this Guide you will see special symbols alerting you to important warnings, notes and actions. To make things clearer and to help you press the correct keys, we used special fonts and added some of the messages that will appear in the LCD.

- Bold** Bold typeface identifies specific keys on the machine control panel.
- Italics* Italicized typeface emphasizes an important point or refers you to a related topic.
- Courier New Courier New type face identifies the messages on the LCD of the machine.

-  Warnings inform you what to do to avoid possible personal injury.
-  Cautions specify procedures you must follow or avoid to prevent possible damage to the machine or other objects.
-  Notes tell you how you should respond to a situation that may arise or give tips about how the operation works with other features.
-  Improper Setup alerts you to devices and operations that are not compatible with the machine.

Control panel overview

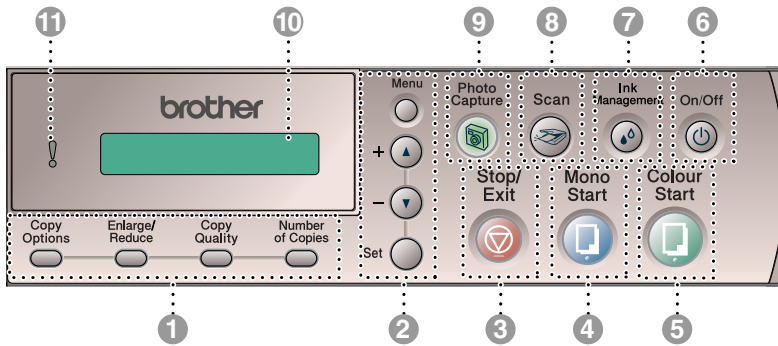

1 Copy keys

(Temporary settings):

Copy Options

You can quickly and easily select temporary settings for copying.

Enlarge/Reduce

Lets you enlarge or reduce copies depending on the ratio you select.

Copy Quality

Use this key to temporarily change the quality for copying.

Number of Copies

Use this key to make multiple copies.

2 Menu keys:

Menu

Lets you access the Menu to program.









+  or - 

Press to scroll through the menus and options.

Also you can use these keys to enter the number.

Set



Lets you store your settings in the machine.

- 3  **Stop/Exit**
Stops an operation or exits from the menu.
- 4  **Mono Start**
Lets you start making copies in black and white.
Also, lets you start a scanning operation (in colour or black, depending on the scanning setting in the ControlCenter2 software).
- 5  **Colour Start**
Lets you start making copies in full colour.
Also, lets you start a scanning operation (in colour or black, depending on the scanning setting in the ControlCenter2 software).
- 6  **On/Off**
You can turn the machine on or off. If you turn the machine off, it will still periodically clean the print head to maintain print quality.
- 7  **Ink Management**
Lets you clean the print head, check the print quality, and check the available ink volume.
- 8  **Scan**
Lets you access Scan mode.
- 9  **PhotoCapture**
Lets you access the PhotoCapture Center™.
- 10 **Liquid Crystal Display (LCD)**
Displays messages on the screen to help you set up and use your machine.
The LCD examples in this guide are for models with a one-line display. There may be slight differences between the examples provided and models with a two-line display.
- 11  **Warning LED**
Turns red when LCD displays an error or an important status message.

Warning LED indications

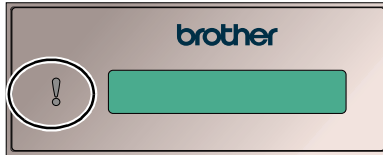
The Warning LED (Light Emitting Diode) lights when there is a problem with your machine. You should check the LCD displays for more details about the problem.



LED	Machine status	Description
 Off	Ready	The machine is ready for use.
 Red	Cover open	The cover is open. Close the cover. (See <i>Error messages</i> on page 6-1.)
	Ink empty	Replace the Ink cartridge with a new one. (See <i>Replacing the ink cartridges</i> on page 6-22.)
	Paper error	Put paper in the tray or clear the paper jam. Check the LCD message. (See <i>Troubleshooting and routine maintenance</i> on page 6-1.)
	Others	Check the LCD message. (See <i>Troubleshooting and routine maintenance</i> on page 6-1.)

Load documents

You can make copies and scan from the ADF (automatic document feeder) or from the scanner glass (flatbed).

Using the ADF (automatic document feeder) (DCP-120C only)

The ADF can hold up to 10 pages and feeds each sheet individually. Use standard (80 gsm) paper and always fan the pages before putting them in the ADF.

-  DO NOT use paper that is curled, wrinkled, folded, ripped, stapled, paper clipped, pasted or taped.
DO NOT use cardboard, newspaper or fabric. (To copy or scan this kind of document, see *Using the scanner glass* on page 1-7.)

Recommended environment

Temperature: 20 to 35°C

Humidity: 50 to 70%

Paper: 80 gsm A4

Available document

Length: 147 to 356 mm

Width: 147 to 216 mm

Weight: 64 to 90 gsm

- Make sure documents written with ink or correction fluid are completely dry.

- 1** Fan the pages well. Make sure you put the documents **face down, top edge first** in the ADF until you feel them touch the feed roller.
- 2** Adjust the paper guides to fit the width of your documents.
- 3** Unfold the ADF Document Output Support Flap.

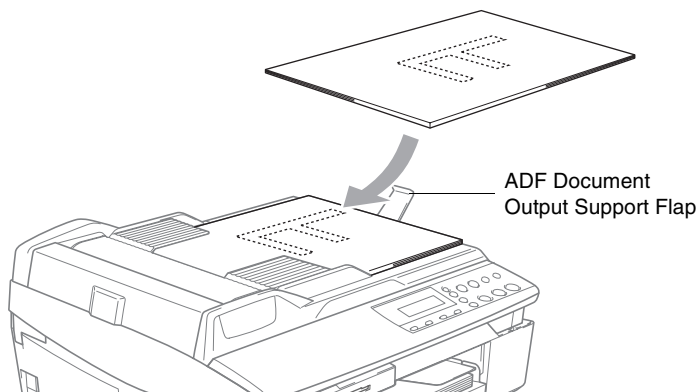

- !** **DO NOT** pull on the document while it is feeding.
- !** To use the ADF, the scanner glass must be empty.

Using the scanner glass

You can use the scanner glass to copy or scan pages of a book or one page at a time. Documents can be up to 216 mm wide and 297 mm long.



(DCP-120C only) To use the scanner glass, the ADF must be empty.

- 1 Lift the document cover.

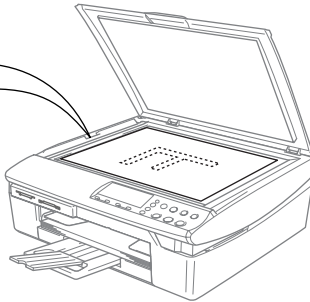

Place documents face down on the Scanner Glass

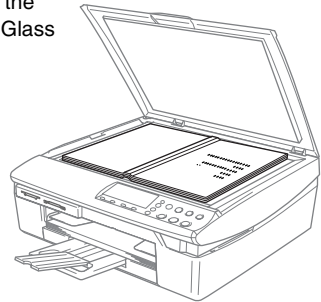

- 2 Using the document guidelines on the left, center the document face down on the scanner glass.

- 3 Close the document cover.



If the document is a book or is thick, do not slam the cover or press on it.

About paper

The print quality can be affected by the type of paper you use in the machine.

To get the best print quality for the settings you've chosen, always set the Paper Type to match the type of paper you load.

You can use plain paper, inkjet paper (coated paper), glossy paper, transparencies and envelopes.

We recommend testing various paper types before purchasing large quantities.

For best results, use the recommended paper.



- When you print on inkjet paper (coated paper), transparencies and glossy paper, be sure to select the proper media in the “Basic” tab of the printer driver or in the Paper Type setting of the menu.
- When you print on Brother glossy paper, load the instruction sheet included with the glossy paper in the paper tray first, and then place the glossy paper on the instruction sheet.
- When you use transparencies or glossy paper, remove each sheet immediately to prevent smudging or paper jams.
- Avoid touching the printed surface of the paper immediately after printing. The surface may not be completely dry and may stain your fingers.

Recommended Paper

To get the best print quality, we suggest using Brother paper. (See table below.)

If Brother paper is not available in your country, we recommend testing various papers before purchasing large quantities.

We recommend using “3M Transparency Film” when you print on transparencies.

Brother Paper

Paper Type	Item
A4 Plain	BP60PA
A4 Glossy	BP60GLA
A4 Inkjet (Photo Matte)	BP60MA
10 x 15 cm Glossy	BP60GLP

Handling and using special paper

- Store paper in its original packaging, and keep it sealed. Keep the paper flat and away from moisture, direct sunlight and heat.
- The coated side of glossy paper is shiny. Avoid touching the shiny (coated) side. Load glossy paper with the shiny side facing down.
- Avoid touching either side of transparencies because they absorb water and perspiration easily, and this may cause decreased output quality. Transparencies designed for laser printers/copiers may stain your next document. Use only transparencies recommended for inkjet printing.



Do not use paper:

- that is damaged, curled, wrinkled, or irregularly shaped

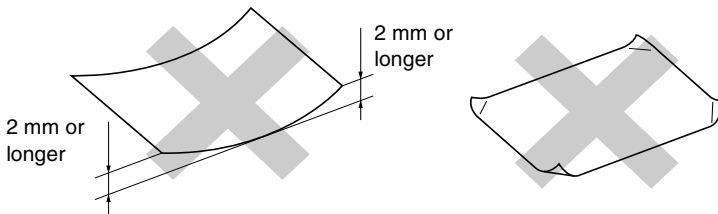

- that is extremely shiny or highly textured
- that was previously printed by a printer
- that cannot be arranged uniformly when stacked
- that is made with a short grain

Paper type and size for each operation

Paper Type	Paper Size	Usage			
		Copy	PhotoCapture	Printer	
Cut Paper	Letter	216 x 279 mm (8 1/2" x 11")	Yes	Yes	
	A4	210 x 297 mm (8.3" x 11.7")	Yes	Yes	
	Legal	216 x 356 mm (8 1/2" x 14")	—	Yes	
	Executive	184 x 267 mm (7 1/4" x 10 1/2")	—	Yes	
	JIS B5	182 x 257 mm (7.2" x 10.1")	—	Yes	
	A5	148 x 210 mm (5.8" x 8.3")	—	Yes	
	A6	105 x 148 mm (4.1" x 5.8")	—	Yes	
	Cards	Photo	102 x 152 mm (4" x 6")	Yes	Yes
Photo L		89 x 127 mm (3 1/2" x 5")	—	Yes	
Photo 2L		127 x 178 mm (5" x 7")	Yes	Yes	
Index Card		127 x 203 mm (5" x 8")	—	Yes	
Post Card 1		100 x 148 mm (3.9" x 5.8")	—	Yes	
Post Card 2 (Double)		148 x 200 mm (5.8" x 7.9")	—	Yes	
Envelopes		C5 Envelope	162 x 229 mm (6.4" x 9")	—	Yes
		DL Envelope	110 x 220 mm (4.3" x 8.7")	—	Yes
	COM-10	105 x 241 mm (4 1/8" x 9 1/2")	—	Yes	
	Monarch	98 x 191 mm (3 7/8" x 7 1/2")	—	Yes	
	JE4 Envelope	105 x 235 mm (4.1" x 9.3")	—	Yes	
	Transparencies	Letter	216 x 279 mm (8 1/2" x 11")	Yes	Yes
A4		210 x 297 mm (8.3" x 11.7")	Yes	Yes	

Paper weight, thickness and capacity

Paper Type		Weight	Thickness	No. of sheets
Cut Paper	Plain Paper	64 to 120 gsm (17 to 32 lb)	0.08 to 0.15 mm (0.003" to 0.006")	100*
	Inkjet Paper	64 to 200 gsm (17 to 53 lb)	0.08 to 0.25 mm (0.003" to 0.01")	20
	Glossy Paper	Up to 220 gsm (Up to 58 lb)	Up to 0.25 mm (Up to 0.01")	20
Cards	Photo Card	Up to 240 gsm (Up to 64 lb)	Up to 0.28 mm (Up to 0.01")	20
	Index Card	Up to 120 gsm (Up to 32 lb)	Up to 0.15 mm (Up to 0.006")	30
	Post Card	Up to 200 gsm (Up to 53 lb)	Up to 0.23 mm (Up to 0.01")	30
Envelopes		75 to 95 gsm (20 to 25 lb)	Up to 0.52 mm (Up to 0.02")	10
Transparencies		—	—	10

* Up to 50 sheets for Legal size paper (80 gsm).

* Up to 100 sheets of 80 gsm.

Paper capacity of the output paper tray

Output Paper Tray	<p>Up to 25 sheets of 80 gsm (A4)</p> <ul style="list-style-type: none"> ■ Transparencies or glossy paper must be picked up from the output paper tray one page at a time to avoid smudging. ■ Legal paper cannot be stacked on the output paper tray.
-------------------	--

Printable area

The figures below show the unprintable areas on cut sheet paper and envelopes.

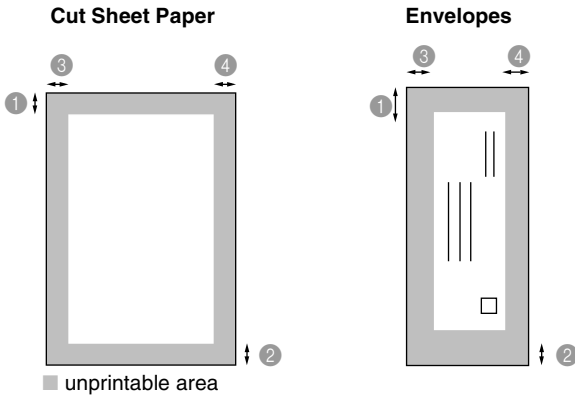

	① Top	② Bottom	③ Left	④ Right
Cut Sheet	3 mm (0 mm)*1	3 mm (0 mm)*1	3 mm (0 mm)*1	3 mm (0 mm)*1
Envelopes	12 mm	24 mm	3 mm	3 mm

*1 When you set the Borderless feature to On.



- Printable area depends on the Printer driver settings.
- The figures above are approximate and the printable area may vary depending on the type of cut sheet paper you are using.

How to load paper, envelopes and post cards

To load paper or other media

- 1 Pull the paper tray completely out of the machine and remove the output paper tray.

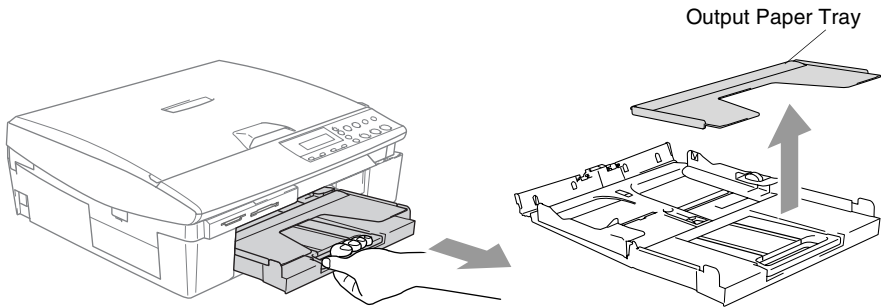

- 2 Press and slide the paper side guide to fit the paper width.

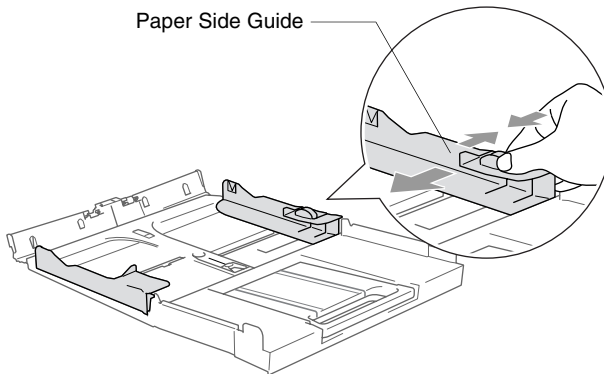

- 3 Pull out the paper support and unfold the paper support flap.

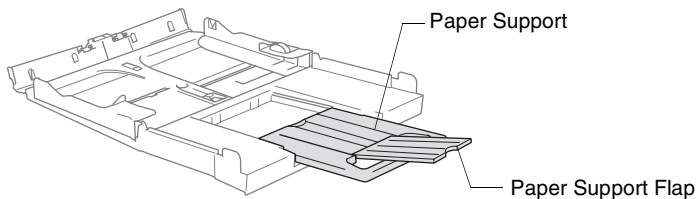

- Use the paper support flap for Letter, Legal and A4.



- 4** Fan the stack of paper well to avoid paper jams and mis-feeds.

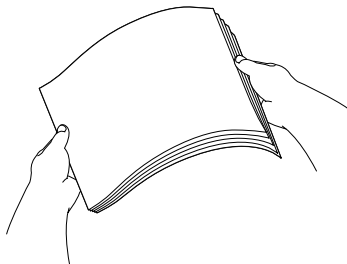

- 5** Gently insert the paper into the paper tray print side down and the leading edge (top of the paper) in first.

Check that the paper is flat in the tray and below the maximum paper mark.

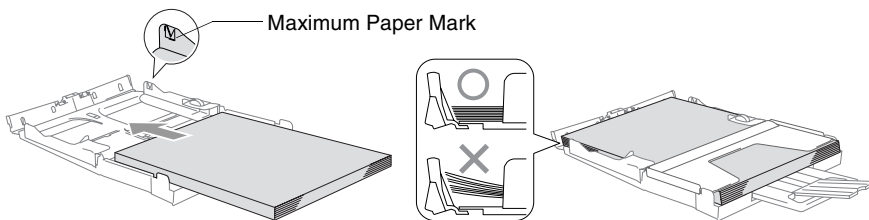

- Make sure the paper side guides touch the sides of the paper.

- Be careful that you do not push the paper in too far; it may lift at the back of the tray and cause feed problems.

- 6** Put the output paper tray back on and push the paper tray firmly back into the machine.

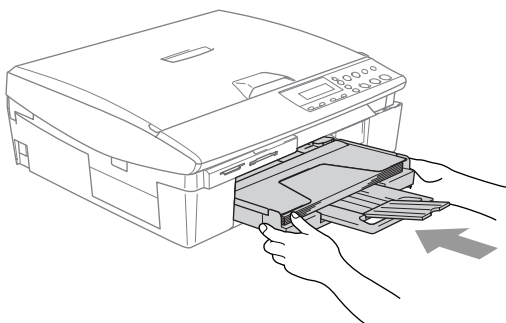

To load envelopes

- Use envelopes that weigh from 75-95 gsm.
- Some envelopes require margin settings in the application. Make sure you do a test print first.
- ⊘ To prevent possible damage to the feeding mechanism, do not use the types of envelopes shown below.

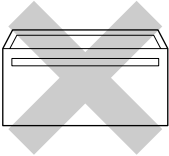
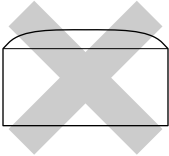
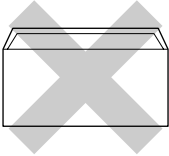
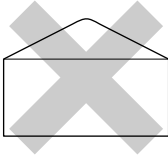
DO NOT USE ENVELOPES:			
<ul style="list-style-type: none">■ that are of a baggy construction■ that are embossed (have raised writing on them)■ that have clasps on them■ that are not sharply creased■ that are preprinted on the inside			
■ Glue	■ Rounded flap	■ Double flap	■ Triangular flap
			

How to load envelopes

1 Before loading, press the corners and sides of the envelopes to make them as flat as possible.

 If the envelopes are 'double-feeding', put one envelope in the paper tray at a time.

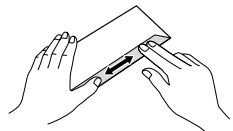
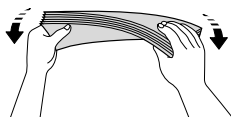
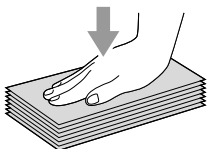

- 2 Insert the envelopes into the paper tray with the address side down and the leading edge (top of the envelopes) in first. Slide the paper side guide to fit the width of the envelopes.

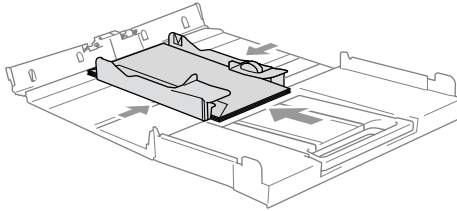

If you have problems when printing on envelopes, try the following suggestions:

- 1 Open the envelope flap.
- 2 Make sure the open flap is either to the side of the envelope or to the back edge of the envelope when printing.
- 3 Adjust the size and margin in your application.

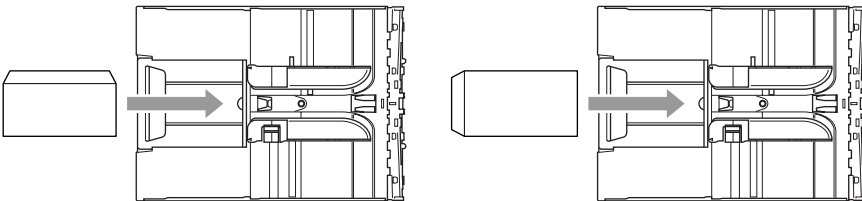

To load post cards

- 1 Raise the paper stop and insert the post cards into the paper tray. Slide the paper side guide to fit the width of the post cards.

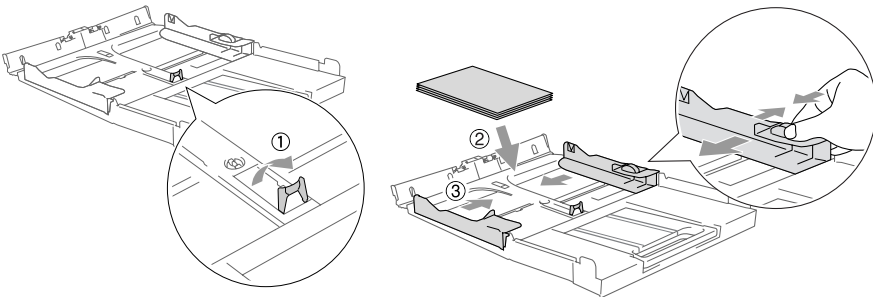

2 Making copies

Using the machine as a copier

You can use your machine as a copier, making up to 99 copies at a time.

Making a single copy

- 1 Load your document.
- 2 Press **Mono Start** or **Colour Start**.

 To stop copying, press **Stop/Exit**.



Making multiple copies

- 1 Load your document.
- 2 Press **Number of Copies** repeatedly until the number of copies you want appears (up to 99).

—OR—

Press  to increase the number of copies.

Press  to decrease the number of copies.

 The number of copies can also be increased/decreased by holding down  or .

- 3 Press **Mono Start** or **Colour Start**.

 (DCP-120C only) To sort the copies, press the **Copy Options** key. (See *Changing the temporary copy settings* on page 2-6.)

Stop copying

To stop copying, press **Stop/Exit**.

Using the Copy keys

When you want to quickly change the copy settings temporarily for the next copy, use the temporary Copy keys. You can use different combinations.

Temporary Copy keys

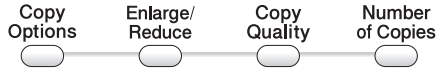

These settings are temporary, the machine returns to its default settings 60 seconds after it finishes copying.



You can save the copy settings you use most often by setting them as default. (See *Changing the default copy settings* on page 2-12.)

Increasing copy speed or quality

You can select the copy quality. The default setting is Normal.

<p>Press Copy Quality</p> 	Normal	Recommended mode for ordinary printouts. Good copy quality with adequate copy speed.
	Fast	Fast copy speed and lowest ink consumption. Use FAST to save time (document to be proof-read, large documents or many copies).
	Best	Use this mode to copy precise images such as photographs. BEST uses the highest resolution and slowest speed.

- 1 Load your document.
- 2 Press **Copy Quality** repeatedly to select the copy quality (Fast, Normal or Best).
- 3 Press **Mono Start** or **Colour Start**.
—OR—
Press other temporary copy keys for more settings.



Enlarging or reducing the image copied

You can select the following enlargement or reduction ratios.

Custom (25-400%) allows you to enter a ratio from 25% to 400%.
(25% to 200% for DCP-116C.)

Press Enlarge/Reduce	Custom (25-400%)
	200%
	198% 10x15cm→A4
	186% 10x15cm→LTR
	142% A5→A4
	104% EXE→LTR
	100%
	97% LTR→A4
	93% A4→LTR
	83%
	78%
	69% A4→A5
	50%





- 1 Load your document.
- 2 Press **Enlarge/Reduce**.
- 3 Press  or  to select the enlargement or reduction ratio you want.



Press **Set**.

—OR—

You can select *Custom* (25-400%) and press **Set**.
(25% to 200% for DCP-116C.)

Press  or  to enter an enlargement or reduction ratio from 25% to 400%.

Press **Set**.

 Enlargement or reduction ratio can also be increased/decreased by holding down  or .

- 4 Press **Mono Start** or **Colour Start**.



—OR—

Press other temporary copy keys for more settings.

 Special Copy Options (2 in 1 (P), 2 in 1 (L), 4 in 1 (P), 4 in 1 (L) or Poster) are not available with **Enlarge/Reduce**.

Changing the temporary copy settings



Use the **Copy Options** key to quickly set the following copy settings temporarily for the next copy.

Press Copy Options 	Menu Selections  Select & Set	Options  Select & Set	Factory Setting	Page
	Paper Type	Plain/ Inkjet/ Glossy/ Transparency	Plain	2-7
	Paper Size	Letter/ Legal/ A4/ A5/ 10 (W) x 15 (H) cm	A4	2-7
	Brightness	- ■■■■ +	- ■■■■ +	2-8
	Stack/Sort (DCP-120C only)	Stack/Sort	Stack	2-8
	Page Layout	Off (1 in 1)/ 2 in 1 (P)/ 2 in 1 (L)/ 4 in 1 (P)/ 4 in 1 (L)/ Poster (3 x 3)	Off (1 in 1)	2-9

After you select your settings by pressing **Set**, the LCD shows Set temporarily and then returns to Menu selections.







Press **Mono Start** or **Colour Start** if you're finished choosing settings.

—OR—

Press  or  to select more settings.

Setting paper type

If copying on paper other than plain paper, select the type of paper that you are using to get the best print quality.







- 1 Load your document.
- 2 Press **Copy Options** and  or  to select Paper Type.
Press **Set**.
- 3 Press  or  to select the type of paper you are using (Plain, Inkjet, Glossy or Transparency).
Press **Set**.
- 4 Press **Mono Start** or **Colour Start**.
—OR—
Press  or  for more settings.

Setting paper size

If copying on paper other than A4 size, you will need to change the paper size setting.



You can copy on Letter, Legal, A4, A5 or Photo Card (10(W) cm x 15(H) cm) paper.

- 1 Load your document.
- 2 Press **Copy Options** and  or  to select Paper Size.
Press **Set**.
- 3 Press  or  to select the size of paper you are using (Letter, Legal, A4, A5 or 10 (W) x 15 (H) cm).
Press **Set**.
- 4 Press **Mono Start** or **Colour Start**.
—OR—
Press  or  for more settings.

Adjusting brightness

You can adjust the copy brightness to make copies darker or lighter.

- 1 Load your document.
- 2 Press **Copy Options** and  or  to select **Brightness**.

Press **Set**.



- 3 Press  to make a lighter copy.

—OR—

Press  to make a darker copy.

Press **Set**.

- 4 Press **Mono Start** or **Colour Start**.

—OR—

Press  or  for more settings.

Sorting copies using the ADF (DCP-120C only)

You can sort multiple copies. Pages will be stacked in the order 321, 321, 321, and so on.

- 1 Load your document.
- 2 Press **Copy Options** and  or  to select **Stack/Sort**.

Press **Set**.

- 3 Press  or  to select **Sort**.

Press **Set**.

- 4 Press **Mono Start** or **Colour Start**.

Making N in 1 copies or a poster (Page Layout)

You can reduce the number of pages for copies by using the N in 1 copy feature. This allows you to copy two or four pages onto one page, allowing you to save paper. It is also possible to create a poster. When you use the Poster feature your machine divides your document into sections, then enlarges the sections so you can assemble them into a poster. If you want to make a poster, use the scanner glass.



- Please make sure Paper Size is set to A4 or Letter.
- You can use the N in 1 copy feature with 100% copy size only.
- (P) means Portrait and (L) means Landscape.
- ADF is not available for DCP-115C, DCP-116C and DCP-315CN.

- 1 Load your document.
- 2 Press **Copy Options** and or to select Page Layout. Press **Set**.
- 3 Press or to select 2 in 1 (P), 2 in 1 (L), 4 in 1 (P), 4 in 1 (L) or Poster (3 x 3). Press **Set**.
- 4 Press **Mono Start** to scan the document.
You can also press **Colour Start** if you are using Poster layout or if you are using a DCP-315CN.
- 5 If you are making a poster or placed the document in the ADF, the machine scans the page and starts printing.

If you are using the scanner glass:

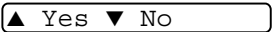
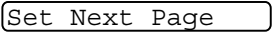
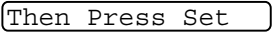
- 6 After the machine scans the page, the LCD shows:
Press to scan the next page.

- 7 Put the next document on the scanner glass.
Press **Set**.

- 8 Repeat Steps 6 and 7 for each page of the layout.
- 9 After all the pages of the document have been scanned, press to end.



If Glossy has been selected in the Paper Type setting for N in 1 copies, the machine will print the images as if Normal paper had been selected.



- If you are producing multiple colour copies, N in 1 copies are not available for DCP-315CN.
- N in 1 colour copies are not available for DCP-115C, DCP-116C and DCP-120C.
- For Poster copies, you cannot make more than one copy.

Place the document face down in the direction shown below.

2 in 1 (P)



2 in 1 (L)

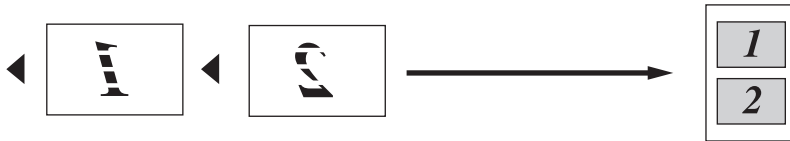

4 in 1 (P)



4 in 1 (L)



Poster (3x3)

You can make a poster size copy of a photograph.

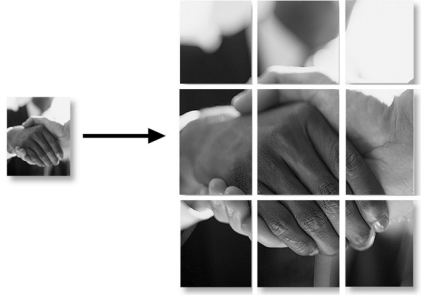







Changing the default copy settings

You can save the copy settings you use most often by setting them as default. These settings will remain until you change them again.

Setting Paper Type

To get the best print quality, set the machine for the type of paper you are using.

- 1** Press **Menu**.
- 2** Press  or  to select 1 . Copy.
Press **Set**.
- 3** Press  or  to select 1 . Paper Type.
Press **Set**.
- 4** Press  or  to select Plain, Inkjet, Glossy or Transparency.
Press **Set**.
- 5** Press **Stop/Exit**.



The machine ejects paper with printed surfaces face up onto the paper tray in the front of the machine. When you use transparencies or glossy paper, remove each sheet immediately to prevent smudging or paper jams.

Setting Paper Size







You can use five sizes of paper for printing your copies: Letter, Legal, A4, A5 and Photo Card (10x15cm). When you change the type of paper you load in the machine, you will need to change the setting for Paper Size at the same time so your machine can fit the copy on the page.

- 1** Press **Menu**.
- 2** Press **▲** or **▼** to select 1.Copy.
Press **Set**.
- 3** Press **▲** or **▼** to select 2.Paper Size.
Press **Set**.
- 4** Press **▲** or **▼** to select Letter, Legal, A4, A5 or 10x15cm.
Press **Set**.
- 5** Press **Stop/Exit**.

Increasing copy speed or quality







- 1** Press **Menu**.
- 2** Press **▲** or **▼** to select 1.Copy.
Press **Set**.
- 3** Press **▲** or **▼** to select 3.Quality.
Press **Set**.
- 4** Press **▲** or **▼** to select Fast, Normal or Best.
Press **Set**.
- 5** Press **Stop/Exit**.

Adjusting brightness

- 1 Press **Menu**.
- 2 Press  or  to select 1 .Copy.
Press **Set**.
- 3 Press  or  to select 4 .Brightness.
Press **Set**.
- 4 Press  to make a lighter copy.
—OR—
Press  to make a darker copy.
Press **Set**.
- 5 Press **Stop/Exit**.

Adjusting contrast

You can change the contrast to help an image look sharper and more vivid.

- 1 Press **Menu**.
- 2 Press  or  to select 1 .Copy.
Press **Set**.
- 3 Press  or  to select 5 .Contrast.
Press **Set**.
- 4 Press  to increase the contrast.
—OR—
Press  to decrease the contrast.
Press **Set**.
- 5 Press **Stop/Exit**.



Adjusting Colour saturation

Colour Saturation can only be changed through the default setting.

1 Press **Menu**.

2 Press  or  to select 1 . Copy.

Press **Set**.

3 Press  or  to select 6 . Color Adjust.

Press **Set**.

4 Press  or  to select Red, Green Or Blue.

Press **Set**.

5 Press  to increase the colour saturation.

—OR—

Press  to decrease the colour saturation.

Press **Set**.

6 Return to Step 4 to select the next colour.

—OR—

Press **Stop/Exit**.

Legal limitations

Colour reproductions of certain documents are illegal and may result in either criminal or civil liability. This memorandum is intended to be a guide rather than a complete listing of every possible prohibition. In case of doubt, we suggest that you check with relevant authorities as to any particular questionable documents.

The following are examples of documents which should not be copied:

- Money
- Bonds or other certificates of debt
- Certificates of Deposit
- Service or Draft papers of the Armed Forces
- Passports
- Postage Stamps (cancelled or uncanceled)
- Immigration Papers
- Welfare documents
- Cheques or Drafts drawn by Governmental Agencies
- Documents, badges or insignias of identification
- Licences and Certificates of Title to motor vehicles

Works subject to Copyright cannot be copied. Sections of works subject to Copyright can be copied for 'fair use'. Multiple copies would indicate improper use.

Works of art should be considered as works subject to Copyright.

3

Walk-Up PhotoCapture Center™

Introduction

Even if your machine is not connected to your computer, you can print photos directly from your digital camera media. Your Brother machine includes media drives (slots) for use with popular digital camera media: CompactFlash®, SmartMedia®, Memory Stick®, Memory Stick Pro™, SecureDigital™ (SD Card), MultiMediaCard™ and xD-Picture Card™.



CompactFlash®
(Type I only)



SmartMedia®



Memory Stick®
Memory Stick Pro™



SecureDigital™
MultiMediaCard™



xD-Picture Card™

The PhotoCapture Center™ feature lets you print digital photos from your digital camera at high resolution to get photo quality printing.



- miniSD™ can be used with miniSD™ adapter.
- Memory Stick Duo™ can be used with Memory Stick Duo™ adapter.
- Memory Stick Pro Duo™ can be used with Memory Stick Pro Duo™ adapter.
- Adapters are not included with the machine. Contact a third party supplier for adapters.

PhotoCapture Center™ requirements

Your machine is designed to be compatible with modern digital camera image files and media cards; however, please read the points below to avoid errors:

- The media card must be in a DPOF format.
(See *DPOF printing* on page 3-8.)
- The image file extension must be .JPG (Other image file extensions .JPEG, .TIF, .GIF and so on will not be recognized).
- Walk-up PhotoCapture Center™ printing must be performed separately from PhotoCapture Center™ operations using the PC. (Simultaneous operation is not available.)
- IBM Microdrive™ is not compatible with the machine.
- The machine can read up to 999 files in a media card.
- Use only Smart media cards with a 3.3v voltage rating.
- CompactFlash® Type II is not supported.
- xD-Picture Card™ Type M (Large Capacity) is supported.



When printing the INDEX or IMAGE, the PhotoCapture Center™ will print all the valid images, even if one or more images have been corrupted. A portion of the corrupted image may be printed.



Your machine is designed to read media cards that have been formatted by a digital camera.

When a digital camera formats a media card it creates a special folder into which it copies image data. If you need to modify the image data stored on a media card with your PC, we recommend that you do not modify the folder structure created by the digital camera. When saving new or modified image files to the media card we also recommend you use the same folder your digital camera uses. If the data is not saved to the same folder the machine may not be able to read the file or print the image.

Getting started

Firmly insert the card into the appropriate slot.

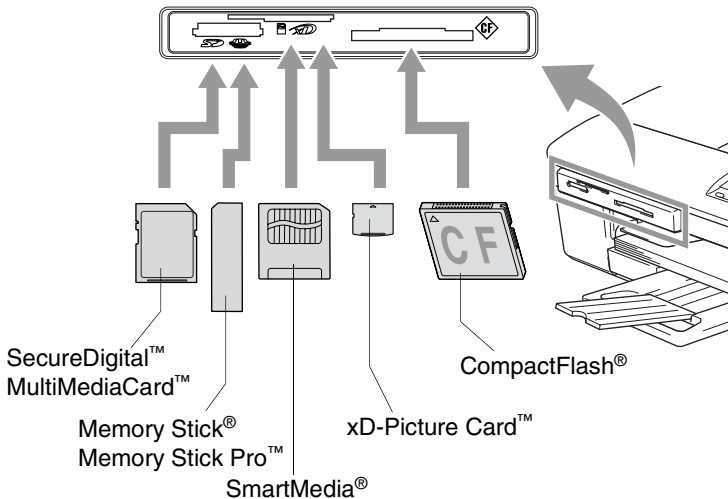

PhotoCapture key indications:

- **PhotoCapture** light is ON, the media card is inserted properly.
- **PhotoCapture** light is OFF, the media card is not properly inserted.
- **PhotoCapture** light is BLINKING, the media card is being read or written to.

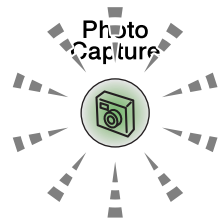

- ⚠ Do NOT unplug the power cord or remove the media card from the media drive (slot) while the machine is reading or writing to the card (the **PhotoCapture** key is blinking). **You will lose your data or damage the card.**

The machine can only read one media card at a time so do not insert more than one card.

The steps below give a brief outline of the Direct Printing feature. Please see the remaining pages of this chapter for more detailed instructions.

- 1** Insert the media card firmly into the media drive (slot).

When you insert your media card into the proper slot, the LCD shows:

C.Flash Active

Press PhotoCapture key...





The media active message will be shown for 60 seconds and then disappear. Even in that case, you can enter the PhotoCapture mode by pressing **PhotoCapture**.

- 2** Press  (**PhotoCapture**).

If your digital camera supports DPOF printing, see *DPOF printing* on page 3-8.

- 3** Print the index that shows thumbnail views of the photos stored on your media card. Your machine will assign an image number to each thumbnail.

Press  or  to select `Print Index` and then press **Set**.

Press **Colour Start** to start printing index sheet.

(See *Printing the Index (Thumbnails)* on page 3-5.)

- 4** To print the images, press  or  to select `Print Images` and then press **Set**.

Enter image number and press **Set**.

Press **Colour Start** to start printing.

(See *Printing images* on page 3-6.)



You can change the settings for printing images, such as the Paper Type & Paper Size, Print Size and Number of Copies. (See *Printing images* on page 3-6.)

Printing the Index (Thumbnails)

The PhotoCapture Center™ assigns numbers for images (such as No.1, No.2, No.3, and so on).





▶ **No. 1**
DEI.JPG

01. 01. 2003
100KB

It does not recognize any other numbers or file names that your digital camera or PC have used to identify the pictures. You can print a thumbnail page (Index page with 6 or 5 images per line). This will show all the pictures on the media card.



1 Make sure you have inserted the media card.

Press  (**PhotoCapture**). (See page 3-3.)

2 Press  or  to select
Print Index.

Print Index ▾

Press **Set**.

3 Press  or  to select
6 Images/Line or
5 Images/Line.

6 Images/Line ▾

Press **Set**.

Index



5 Images/Line

Index

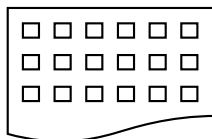

6 Images/Line

4 Press **Colour Start** to start printing.



Print time for 5 Images/Line will be slower than 6 Images/Line, but the quality is better. To print an image, see *Printing images* on page 3-6.



Printing images

Before you can print an individual image, you have to know the image number.

1 Print the Index first.
(See *Printing the Index (Thumbnails)* on page 3-5.)

2 Make sure you have inserted the media card.

Press  (**PhotoCapture**). (See page 3-3.)

3 Press  or  to select
Print Images.

Print Images ▾

Press **Set**.



 If your media card contains valid DPOF information, the LCD shows DPOF Print:Yes, please go to *DPOF printing* on page 3-8.

4 Press  repeatedly to enter the
image number that you want to print
from the Index page (Thumbnails).

No. : 1, 3, 6

Press **Set**.

Repeat this step until you have entered all the image numbers
that you want to print.

 ■ Press  to decrease the image number.

■ You can enter all the numbers at one time by using the
Copy Options key for hyphen.



(For example, Enter **1, Copy Options, 5** to print images
No.1 to No.5).

5 After you have selected all the image numbers, press **Set** again,
and go to Step 6.

—OR—

If you have finished choosing settings, press **Colour Start**.

Paper Type & Paper Size

- 6** Press  or  to select the type of paper you are using (Letter Glossy, 10x15cm Glossy, 13x18cm Glossy, A4 Glossy, Letter Plain, A4 Plain, Letter Inkjet, A4 Inkjet or 10x15cm Inkjet).

Press **Set**.



If you selected A4 or Letter, go to Step 7.

If you selected another size, go to Step 8.

—OR—

If you have finished choosing settings, press **Colour Start**.

Print Size





- 7** If you selected A4 or Letter, press  or  to select the print size (10x8cm, 13x9cm, 15x10cm, 18x13cm, 20x15cm or Max. Size).

Press **Set**, and go to Step 8.

—OR—

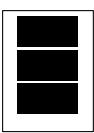
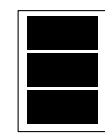
If you have finished choosing settings, press **Colour Start**.

Printed Position for A4

1 10 x 8cm	2 13 x 9cm	3 15 x 10cm	4 18 x 13cm	5 20 x 15cm	6 Max. Size
					

Number of Copies

- 8** Press  to enter the number of copies you want.

Press **Set**.



Press  to decrease the number of copies.

- 9** Press **Colour Start** to print.



Your temporary settings will be kept until you take out the media card from the drive (slot), print images or press **Stop/Exit**.

DPOF printing

DPOF stands for Digital Print Order Format.

Major Digital Camera manufacturers (Canon Inc., Eastman Kodak Company, Fuji Photo Film Co. Ltd., Matsushita Electric Industrial Co. Ltd. and Sony Corporation.) created this standard to make it easier to print images from a digital camera.

If your digital camera supports DPOF printing, you will be able to select on the Digital Camera display the images and number of copies you want to print.

When the memory card (CompactFlash®, SmartMedia®, Memory Stick®, Memory Stick Pro™, SecureDigital™, MultiMediaCard™ and xD-Picture Card™) containing DPOF information is put into your machine, you can print the selected image easily.



- 1 Insert your media card into the proper drive (slot).

C.Flash Active





The media active message will be shown for 60 seconds and then disappear. Even in that case, you can enter the PhotoCapture mode by pressing **PhotoCapture**.



- 2 Press  (**PhotoCapture**).



- 3 Press  or  to select Print Images.
Press **Set**.

- 4 If there is a DPOF file on the card, the LCD shows:

DPOF Print:Yes 

- 5 Press  or  to select DPOF Print:Yes.
Press **Set**.

- 6 Press  or  to select Letter Glossy, 10x15cm Glossy, 13x18cm Glossy, A4 Glossy, Letter Plain, A4 Plain, Letter Inkjet, A4 Inkjet or 10x15cm Inkjet.
Press **Set**.

If you selected Letter or A4, press  or  to select the print size (10x8cm, 13x9cm, 15x10cm, 18x13cm, 20x15cm or Max. Size).

Press **Set**.

- 7 Press **Colour Start** to print.

Changing the default settings

You can save the PhotoCapture Center™ settings you use most often by setting them as default. These settings will remain until you change them again.







Increasing print speed or quality

- 1** Press **Menu**.
- 2** Press **▲** or **▼** to select **2 . PhotoCapture**.
Press **Set**.
- 3** Press **▲** or **▼** to select **1 . Print Quality**.
Press **Set**.
- 4** Press **▲** or **▼** to select **Normal** or **Photo**.
Press **Set**.
- 5** Press **Stop/Exit**.

Setting paper and size







- 1** Press **Menu**.
- 2** Press **▲** or **▼** to select **2 . PhotoCapture**.
Press **Set**.
- 3** Press **▲** or **▼** to select **2 . Paper & Size**.
Press **Set**.
- 4** Press **▲** or **▼** to select **Letter Glossy, 10x15cm Glossy, 13x18cm Glossy, A4 Glossy, Letter Plain, A4 Plain, Letter Inkjet, A4 Inkjet** or **10x15cm Inkjet**.
Press **Set**.
- 5** If you selected **A4** or **Letter**, press **▲** or **▼** to select the print size (**10x8cm, 13x9cm, 15x10cm, 18x13cm, 20x15cm** or **Max . Size**).
Press **Set**.
- 6** Press **Stop/Exit**.

Adjusting brightness

- 1 Press **Menu**.
- 2 Press  or  to select 2 .PhotoCapture.
Press **Set**.
- 3 Press  or  to select 3 .Brightness.
Press **Set**.
- 4 Press  to make a lighter print.
—OR—
Press  to make a darker print.
Press **Set**.
- 5 Press **Stop/Exit**.







Adjusting contrast

You can select the contrast setting. More contrast will make an image look sharper and more vivid.

- 1 Press **Menu**.
- 2 Press  or  to select 2 .PhotoCapture.
Press **Set**.
- 3 Press  or  to select 4 .Contrast.
Press **Set**.
- 4 Press  to increase the contrast.
—OR—
Press  to decrease the contrast.
Press **Set**.
- 5 Press **Stop/Exit**.

Colour enhancement

You can turn on the colour enhancement feature to print more vivid images. Printing time will be slower.





- 1** Press **Menu**.
- 2** Press  or  to select 2.PhotoCapture.
Press **Set**.
- 3** Press  or  to select 5.Color Enhance.
Press **Set**.
- 4** Press  or  to select On.
Press **Set**.

—OR—

Select **Off** and press **Set**, then go to Step 7.



If you select **On**, you can customize the White Balance, Sharpness or Colour Density.

- 5** Press  or  to select 1.White Balance, 2.Sharpness or 3.Color Density.
Press **Set**.
- 6** Press  or  to adjust the degree of setting.
Press **Set**.
- 7** Press **Stop/Exit**.

■ White Balance

This setting adjusts the hue of the white areas of an image. Lighting, camera settings and other influences will effect the appearance of white. The white areas of a picture may be slightly pink, yellow or some other colour. By using this adjustment you can correct this effect and bring the white areas back to pure white.

■ Sharpness

This setting enhances the detail of an image. It is similar to adjusting the fine focus on a camera. If the image is not in true focus and you cannot see the fine details of the picture, then adjust the sharpness.

■ Colour Density

This setting adjusts the total amount of colour in the image. You can increase or decrease the amount of colour in an image to improve a washed out or weak picture.

Cropping

If your photo is too long or wide to fit the available space on your selected layout, part of the image will be automatically cropped.

The default setting is **On**. If you want to print the whole image, turn this setting to **Off**.

- 1** Press **Menu**.
- 2** Press **▲** or **▼** to select **2.PhotoCapture**.
Press **Set**.
- 3** Press **▲** or **▼** to select **6.Cropping**.
Press **Set**.
- 4** Press **▲** or **▼** to select **Off (or On)**.
Press **Set**.
- 5** Press **Stop/Exit**.

Cropping: On

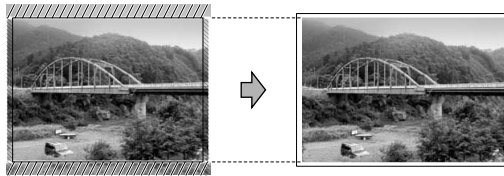



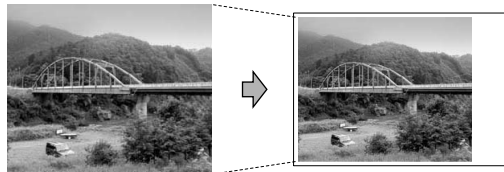



Cropping: Off



Borderless

This feature expands the printable area to fit the edges of the paper. Printing time will be slightly slower.

- 1 Press **Menu**.
- 2 Press  or  to select 2 .PhotoCapture.
Press **Set**.
- 3 Press  or  to select 7 .Borderless.
Press **Set**.
- 4 Press  or  to select Off (or On).
Press **Set**.
- 5 Press **Stop/Exit**.

Scan to Card (DCP-115C, DCP-120C and DCP-315CN only)







You can scan black and white and colour documents onto a media card. Black and white documents will be stored in PDF (*.PDF) or TIFF file formats (*.TIF). Colour documents may be stored in PDF (*.PDF) or JPEG (*.JPG) file formats. The default setting is Color 150 dpi and the default file format is PDF. File names default to the current date. For example, the fifth image scanned on July 1, 2005 would be named 01070505.PDF. You can change the colour and quality as you want.

Quality	Selectable File Format	Default File Format
B/W 200x100 dpi	TIFF / PDF	TIFF
B/W 200 dpi	TIFF / PDF	TIFF
Color 150 dpi	JPEG / PDF	PDF
Color 300 dpi	JPEG / PDF	PDF
Color 600 dpi	JPEG / PDF	PDF











You can select the default file format for Black & White or colour files. (See *Changing the default black & white file format* on page 3-15 and *Changing the default colour file format* on page 3-15.)









- 1 Insert a SmartMedia[®], CompactFlash[®], Memory Stick[®], Memory Stick Pro[™], SecureDigital[™], MultiMediaCard[™] or xD-Picture Card[™] into your machine.

- 1 Do not take out the media card while **PhotoCapture** is blinking to avoid damaging the card or data stored on the card.
- 2 Load your document.
- 3 Press  (**Scan**).
- 4 Press  or  to select **Scan to Card**.
To change quality, press **Set** and go to Step 5.
—OR—
Press **Mono Start** or **Colour Start** to start scanning without changing any settings.
- 5 Press  or  to select the quality you want.
To change the file type, press **Set** and go to Step 6.
—OR—
To start scanning, press **Mono Start** or **Colour Start**.
- 6 Press  or  to select the file type you want.
Press **Mono Start** or **Colour Start** to start scanning.









Changing the default quality

- 1 Press **Menu**.
- 2 Press  or  to select 2.PhotoCapture.
Press **Set**.
- 3 Press  or  to select 8.Scan to Card.
Press **Set**.
- 4 Press  or  to select 1.Quality.
Press **Set**.
- 5 Press  or  to select B/W 200x100 dpi, B/W 200 dpi, Color 150 dpi, Color 300 dpi or Color 600 dpi.
Press **Set**.
- 6 Press **Stop/Exit**.

Changing the default black & white file format

- 1 Press **Menu**.
- 2 Press  or  to select 2.PhotoCapture.
Press **Set**.
- 3 Press  or  to select 8.Scan to Card.
Press **Set**.
- 4 Press  or  to select 2.B/W File Type.
Press **Set**.
- 5 Press  or  to select TIFF or PDF.
Press **Set**.
- 6 Press **Stop/Exit**.

Changing the default colour file format

- 1 Press **Menu**.
- 2 Press  or  to select 2.PhotoCapture.
Press **Set**.
- 3 Press  or  to select 8.Scan to Card.
Press **Set**.
- 4 Press  or  to select 3.ColorFile Type.
Press **Set**.
- 5 Press  or  to select PDF or JPEG.
Press **Set**.
- 6 Press **Stop/Exit**.

Understanding the Error Messages

Once you are familiar with the types of errors that can occur while you're using the PhotoCapture Center™, you can easily identify and troubleshoot any difficulties.

When an error message appears on the LCD, the machine will beep to get your attention.

Media Error—This message will appear if you insert a media card that is either bad or not formatted, or when there is a problem with the media drive. To clear this error, take out the media card.

No File—This message will appear if you try to access a media card in the drive (slot) that does not contain a .JPG file.

Out of Memory—This message will appear if you are working with images that are too large for the machine's memory.

Using PhotoCapture Center™ from your computer

You can access the media card that is in the media drive (slot) of the machine from your PC.

(For Windows® users, see Chapter 7 in Software User's Guide on the CD-ROM and for Macintosh® users see Chapter 12 in Software User's Guide on the CD-ROM.)

4 Software and Network features

The User's Guide on the CD-ROM includes the Software User's Guide and Network User's Guide for features available when connected to a computer (for example, Printing and Scanning).

■ Printing

(For Windows®, see Chapter 1 in the Software User's Guide on the CD-ROM.)

(For Macintosh®, see Chapter 8 in the Software User's Guide on the CD-ROM.)

■ Scanning

(For Windows®, see Chapter 2 in the Software User's Guide on the CD-ROM.)

(For Macintosh®, see Chapter 9 in the Software User's Guide on the CD-ROM.)

■ ControlCenter2

(For Windows®, see Chapter 3 in the Software User's Guide on the CD-ROM.)

(For Macintosh®, see Chapter 10 in the Software User's Guide on the CD-ROM.)

■ Network Scanning (DCP-315CN only)

(For Windows®, see Chapter 4 in the Software User's Guide on the CD-ROM.)

(For Macintosh®, see Chapter 11 in the Software User's Guide on the CD-ROM.)

■ PhotoCapture Center™

(For Windows®, see Chapter 7 in the Software User's Guide on the CD-ROM.)

(For Macintosh®, see Chapter 12 in the Software User's Guide on the CD-ROM.)

■ Network Printing (DCP-315CN only)

(See Network User's Guide on the CD-ROM.)



See *How to access the complete User's Guide* on page v.

5 Important information

For your safety

To ensure safe operation the supplied three-pin plug must be inserted only into a standard three-pin electrical socket that is effectively grounded through the normal household wiring.

The fact that the equipment operates satisfactorily does not imply that the power is grounded and that the installation is completely safe. For your safety, if in any doubt about the effective grounding of the power, consult a qualified electrician.

LAN connection (DCP-315CN only)

Caution

Do not connect this product to a LAN connection that is subject to over-voltages.

International ENERGY STAR® Compliance Statement

The purpose of the International ENERGY STAR® Program is to promote the development and popularization of energy-efficient office equipment.

As an ENERGY STAR® Partner, Brother Industries, Ltd. has determined that this product meets the ENERGY STAR® guidelines for energy efficiency.



Important safety instructions

- 1** Read all of/ these instructions.
- 2** Save them for later reference.
- 3** Follow all warnings and instructions marked on the product.
- 4** Unplug this product from the wall socket before cleaning the outside of the machine and the scanner glass. Do not use liquid or aerosol cleaners. Use a damp cloth for cleaning.
- 5** Do not use this product near water.
- 6** Do not place this product on an unstable cart, stand, or table. The product may fall, causing serious damage to the product.
- 7** Slots and openings in the cabinet and the back or bottom are provided for ventilation; to ensure reliable operation of the product and to protect it from overheating, these openings must not be blocked or covered. The openings should never be blocked by placing the product on a bed, sofa, rug, or other similar surface. This product should never be placed near or over a radiator or heater. This product should never be placed in a built-in installation unless proper ventilation is provided.
- 8** This product should be operated from the type of power source indicated on the label. If you are not sure of the type of power available, call your dealer or local power company.
Use only the power cord supplied with this machine.
- 9** This product is equipped with a 3-wire grounded plug, a plug having a third (grounded) pin. This plug will only fit into a grounded power outlet. This is a safety feature. If you are unable to insert the plug into the outlet, call your electrician to replace your obsolete outlet. Do not defeat the purpose of the grounded plug.
- 10** Do not allow anything to rest on the power cord. Do not place this product where people can walk on the cord.
- 11** Do not place anything in front of the machine that will block printing. Do not place anything in the path of printing.
- 12** Wait until pages have exited the machine before picking them up.

13 Unplug this product from the power socket and refer servicing to Authorized Service Personnel under the following conditions:

- When the power cord is damaged or frayed.
- If liquid has been spilled into the product.
- If the product has been exposed to rain or water.
- If the product does not operate normally when the operating instructions are followed. Adjust only those controls that are covered by the operating instructions. Improper adjustment of other controls may result in damage and will often require extensive work by a qualified technician to restore the product to normal operation.
- If the product has been dropped or the cabinet has been damaged.
- If the product exhibits a distinct change in performance, indicating a need for service.

14 To protect your product against power surges, we recommend the use of a power protection device (Surge Protector).

Trademarks

The Brother logo is a registered trademark of Brother Industries, Ltd.

Brother is a registered trademark of Brother Industries, Ltd.

Multi-Function Link is a registered trademark of Brother International Corporation.

© 2005 Brother Industries, Ltd. All rights reserved.

Windows and Microsoft are registered trademarks of Microsoft in the U.S. and other countries.

Macintosh and TrueType are registered trademarks of Apple Computer, Inc.

PaperPort and OmniPage OCR are registered trademarks of ScanSoft, Inc.

Presto! PageManager is a registered trademark of NewSoft Technology Corporation.

Microdrive is a trademark of International Business Machine Corporation.

SmartMedia is a registered trademark of Toshiba Corporation.

CompactFlash is a registered trademark of SanDisk Corporation.

Memory Stick is a registered trademark of Sony Corporation.

SecureDigital is a trademark of Matsushita Electric Industrial Co.Ltd., SanDisk Corporation and Toshiba Corporation.

SanDisk is a licensee of the SD and miniSD trademarks.

MultiMediaCard is a trademark of Infineon Technologies and licensed to the MultiMediaCard Association.

xD-Picture Card is a trademark of Fuji Photo Film Co. Ltd., Olympus Optical Co. Ltd and Toshiba Corporation.

Memory Stick Pro, Memory Stick Pro Duo, Memory Stick Duo and MagicGate are trademarks of Sony Corporation.

Each company whose software title is mentioned in this manual has a Software License Agreement specific to its proprietary programs.

All other brand and product names mentioned in this User's Guide, the Software User's Guide, and the Network User's Guide (DCP-315CN only) are registered trademarks of their respective companies.

6

Troubleshooting and routine maintenance

Troubleshooting

Error messages

As with any sophisticated office product, errors may occur. If this happens, your machine identifies the problem and displays an error message. The most common error messages are shown below.

You can correct most problems by yourself. If you need additional help, the Brother Solutions Center offers latest FAQs and troubleshooting tips.

Visit us at <http://solutions.brother.com>

ERROR MESSAGES		
ERROR MESSAGE	CAUSE	ACTION
Cover is Open	The scanner cover is not closed completely.	Lift the scanner cover and then close it again.
Data Remaining	Print data remains in the machine's memory.	Re-start printing from your computer.
	Print data remains in the machine's memory. The USB cable was unplugged while the computer was sending the data to the machine.	Press Stop/Exit . The machine will cancel the job and eject the page that is being printed.
Document Jam (DCP-120C only)	The document was not inserted or fed properly, or the document fed from the ADF was too long.	See <i>Using the ADF (automatic document feeder) (DCP-120C only)</i> on page 1-5.
	The document is jammed in the machine.	See <i>Document jams (DCP-120C only)</i> on page 6-3.
High Temperature	The print head is too warm.	Allow the machine to cool down.
Ink Empty	One or more of the ink cartridges is empty. The machine will stop all print operations.	Replace the ink cartridges. (See <i>Replacing the ink cartridges</i> on page 6-22.)
Low Temperature	The print head is too cold.	Allow the machine to warm up.
Media Error	The media card is either corrupted, improperly formatted, or there is a problem with the media drive.	Re-insert the card firmly into the slot to make sure it is in the proper position. If the error remains, check the media drive by inserting another media card that you know is working.

ERROR MESSAGES		
ERROR MESSAGE	CAUSE	ACTION
Near Empty	One or more of the ink cartridges are running out of ink.	Order a new ink cartridge.
No Cartridge	An ink cartridge is not properly installed.	Take out the ink cartridge and put it in again seating it properly. (See <i>Replacing the ink cartridges</i> on page 6-22.)
No File	The media card in the media drive does not contain a .JPG file.	Reinsert the correct media card.
No Paper Fed	The machine is out of paper.	Add paper, and then press Mono Start or Colour Start .
	The paper is jammed in the machine.	See <i>Paper is jammed inside the paper tray</i> on page 6-4 or <i>Paper is jammed inside the machine</i> on page 6-5.
Out of Memory	The machine's memory is full.	(Copy operation in process) Press Stop/Exit and wait until the other operations in progress finish and then try again.
Paper Jam	Paper is jammed in the machine.	See <i>Paper is jammed inside the paper tray</i> on page 6-4 or <i>Paper is jammed inside the machine</i> on page 6-5.
Unable to Change Unable to Clean Unable to Init Unable to Print Unable to Scan	The machine has a mechanical problem. —OR— A foreign obstacle such as a clip or ripped paper is in the machine.	Open the scanner cover and remove any foreign obstacles inside the machine. If the error message continues, disconnect the machine from the power source for several minutes then reconnect it.

Document jams (DCP-120C only)

If the document is jammed, follow the steps below.

Document is jammed in the top of the ADF unit

- 1 Take out any paper from the ADF that is not jammed.
- 2 Open the ADF cover.
- 3 Pull the jammed document out to the right or left.

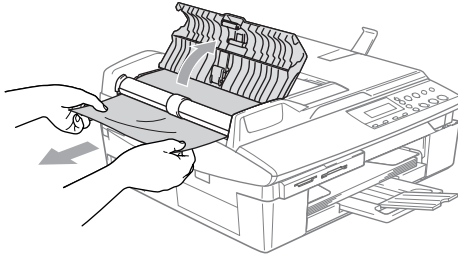

- 4 Close the ADF cover.
Press **Stop/Exit**.

Document is jammed inside the ADF unit

- 1 Take out any paper from the ADF that is not jammed.
- 2 Lift the document cover.
- 3 Pull the jammed document out to the left.

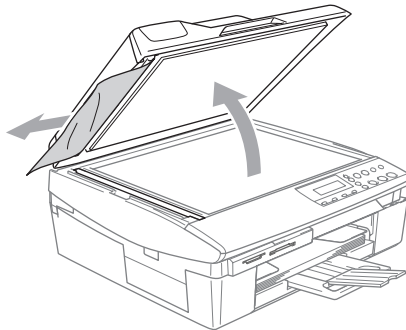

- 4 Close the document cover.
Press **Stop/Exit**.

Printer jam or paper jam

Remove the jammed paper depending on where it is jammed in the machine. Open and close the scanner cover to clear the error.

Paper is jammed inside the paper tray

- 1 Pull the paper tray out of the machine.

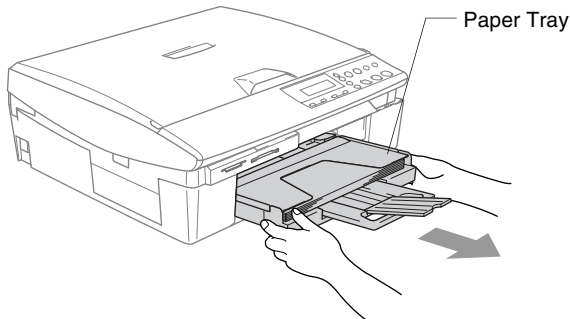

- 2 Pull up the jammed paper to remove it.

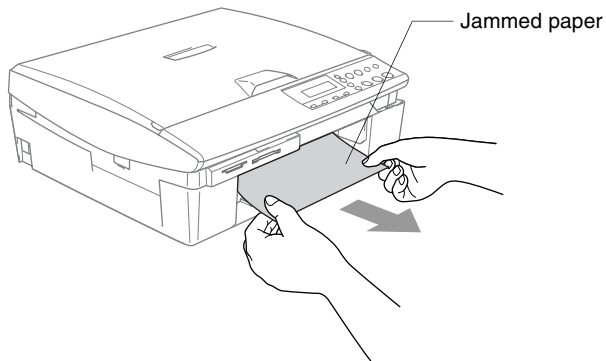

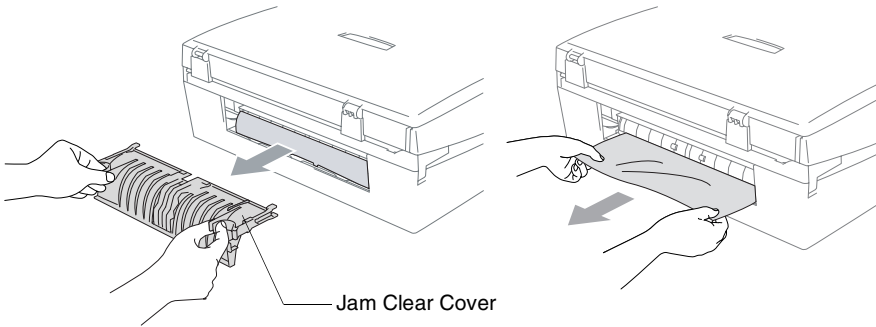

Paper is jammed inside the machine

- 1 Remove the Jam Clear Cover. Pull the jammed paper out of the machine.

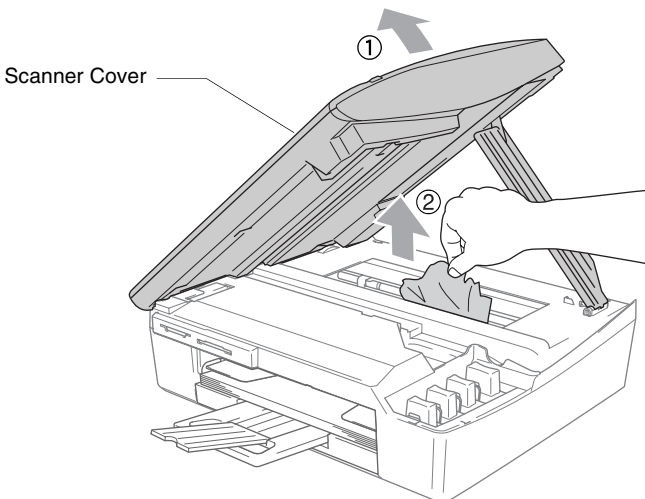

- 2 Re-insert the Jam Clear Cover.
- 3 If you can not pull out the jammed paper, lift the scanner cover from the right-hand side of the machine until it locks securely into the open position.
- 4 Remove the jammed paper.



-  If the paper is jammed underneath the print head, disconnect the machine from the power source so you can move the print head and take out the paper.

- 5** Lift the scanner cover to release the lock. Gently push the scanner cover support and close the scanner cover.

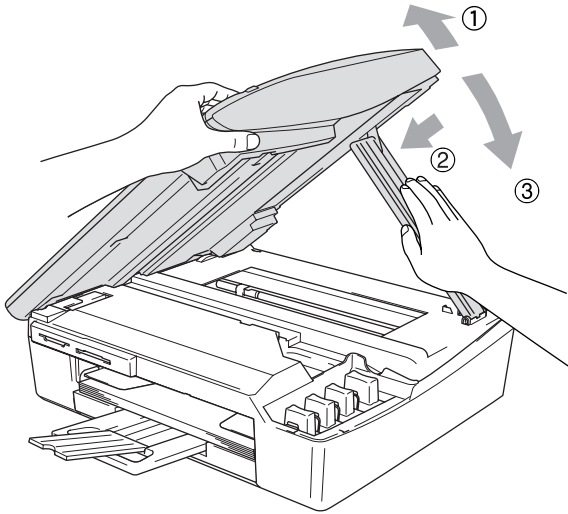

If you are having difficulty with your machine

If you think there is a problem with your machine, check the chart below and follow the troubleshooting tips.

The Brother Solutions Center offers latest FAQs and troubleshooting tips.

Visit us at <http://solutions.brother.com>







DIFFICULTY	SUGGESTIONS
Printing Difficulties	
No printout	Check the interface cable connection on both the machine and your computer.
	One or more ink cartridges are empty. (See <i>Replacing the ink cartridges</i> on page 6-22.)
	Check to see if the LCD is showing an error message. (See <i>Error messages</i> on page 6-1.)
Poor quality print	Check the print quality. (See <i>Checking the print quality</i> on page 6-12.)
	Make sure the Printer Driver or Paper Type setting in the menu matches the type of paper you are using. (For Windows® users, see Chapter 1 in Software User's Guide on the CD-ROM or for Macintosh® users, see Chapter 8 in Software User's Guide on the CD-ROM.)
	Make sure your ink cartridges are fresh. Cartridges remain fresh for up to two years if kept in their original packaging, after that the ink may become clogged. Cartridge expiration dates are printed on the package.
	Try using the recommended types of paper. (See <i>About paper</i> on page 1-8.) The recommended environment for your machine is between 20°C to 33°C.
White horizontal lines appear in text or graphics.	Clean the print head. (See <i>Cleaning the print head</i> on page 6-11.)
	Try using the recommended types of paper. (See <i>About paper</i> on page 1-8.)
	If horizontal bands appear when using plain paper, use the 'Enhanced Normal Printing' mode to help avoid banding on some types of plain paper. In the printer driver 'Basic' tab, click 'Settings', and check 'Enhanced Normal Printing'. If you continue to have horizontal bands, change the Media Type selection to 'Slow Drying Paper' in the printer driver 'Basic' tab to help enhance the print quality.
The machine prints blank pages.	Clean the print head. (See <i>Cleaning the print head</i> on page 6-11.)
Characters and lines are stacked.	Check the printing alignment. (See <i>Checking the printing alignment</i> on page 6-14.)
Printed text or images are skewed.	Make sure the paper is loaded properly in the paper tray and the paper side guide is adjusted correctly. (See <i>How to load paper, envelopes and post cards</i> on page 1-13.)
Smudged stain at the top center of the printed page.	Make sure the paper is not too thick or not curled. (See <i>About paper</i> on page 1-8.)
Printing appears dirty or ink seems to run.	Make sure you are using the proper types of paper. (See <i>About paper</i> on page 1-8.) Don't handle the paper until the ink is dry.
Stains appear on the reverse side or at the bottom of the page.	Make sure the Printer Platen is not dirty with ink. (See <i>Cleaning the machine printer platen</i> on page 6-20.)
	Make sure you are using the paper support flap. (See <i>How to load paper, envelopes and post cards</i> on page 1-13.)
There are some dense lines.	Check 'Reverse Order' in the Basic tab of the printer driver.
The printouts are wrinkled.	In the printer driver 'Basic' tab, click the 'Settings', and uncheck the 'Bi-Directional Printing'.

DIFFICULTY	SUGGESTIONS
Cannot perform '2 in 1 or 4 in 1' printing.	Check that the paper size setting in the application and in the printer driver are the same.
Print speed is too slow.	Changing the printer driver setting may improve the print speed. Highest resolution needs longer data processing, transfer and printing time. Try the other settings of quality in the printer driver 'Basic' tab. Also, click the 'Settings' tab, and make sure you uncheck the Colour Enhancement.
	Borderless printing is slower than normal printing. If you want to print more quickly, set the Borderless feature off. (See Chapter 1 or Chapter 8 in the Software User's Guide on the CD-ROM.)
Colour Enhancement is not working properly.	If the image data is not full colour in your application (Such as 256 colour), Colour Enhancement will not work. Please use at least 24 bit colour data with the Colour Enhancement feature.
The machine feeds multiple pages.	Make sure the paper is loaded properly in the paper tray. (See <i>How to load paper, envelopes and post cards</i> on page 1-13.)
	Check that more than two types of paper are not loaded in the paper tray at any one time.
Printed pages are not stacked neatly.	Make sure you are using the paper support flap. (See <i>How to load paper, envelopes and post cards</i> on page 1-13.)
The machine does not print from Paint Brush.	Try setting the Display setting to '256 colours'.
The machine does not print from Adobe Illustrator.	Try to reduce the print resolution.
Copying Difficulties	
Poor copy results when using the ADF. (DCP-120C only)	Try using the scanner glass. (See <i>Using the scanner glass</i> on page 1-7.)
Vertical streaks appear in copies.	Sometimes you may see vertical streaks on copies. Clean the scanner. (See <i>Cleaning the scanner</i> on page 6-19.)
Scanning Difficulties	
Poor scanning results when using the ADF. (DCP-120C only)	Try using the scanner glass. (See <i>Using the scanner glass</i> on page 1-7.)
TWAIN/WIA errors appear while scanning.	Make sure the Brother TWAIN/WIA driver is selected as the primary source. In PaperPort®, click Scan in the File menu and select the Brother TWAIN/WIA driver.
Software Difficulties	
Cannot install software or print	Run the Repair MFL-Pro Suite program on the CD-ROM. This program will repair and reinstall the software.
'Device Busy'	Make sure the machine is not showing an error message on the LCD.
PhotoCapture Center™ Difficulties	
Removable Disk does not work properly.	<p>a) Have you installed the Windows® 2000 update? If not, do the following:</p> <ol style="list-style-type: none"> 1. Disconnect the USB cable. 2. Install the Windows® 2000 update. Please see the Quick Setup Guide. After the installation the PC will be automatically restarted. 3. Wait about 1 minute after you reboot the PC, and then connect the USB cable. <p>b) Take out the media card and put it back in again.</p> <p>c) If you have tried "Eject" from within Windows®, you must take out the media card before you continue.</p> <p>d) If an error message appears when you try to eject the media card, it means the card is being accessed. Wait a while and then try again.</p> <p>e) If all of the above do not work, please turn off your PC and machine, and then turn them on again. (You will have to unplug the power cord of the machine to turn it off.)</p>
Cannot access Removable Disk from Desktop icon.	Make sure you have inserted the media card into the media slot.

DIFFICULTY	SUGGESTIONS
Network Difficulties (DCP-315CN only)	
I cannot print over the network.	Make sure that your machine is powered on and is On Line and in Ready mode. Print Network Configuration list. (See <i>Printing reports</i> on page A-1.) Then the current settings of the network are printed. Reconnect the LAN cable to the hub to verify that the cabling and network connections are good. If possible, try connecting the machine to a different port on your hub using a different cable. If you have good connections, the machine will show LAN Active for 2 seconds.
The network scanning feature does not work.	(For Windows® users only) Firewall setting on your PC may be rejecting the necessary network connection. Follow the instructions below to disable the Firewall. If you are using a personal Firewall software, see the User's Guide for your software or contact the software manufacturer.
The network PC-Fax Receive feature does not work.	<p><Windows® XP SP2 users.></p> <ol style="list-style-type: none"> 1. Click the 'Start' button, 'Settings', 'Control Panel' and then 'Windows Firewall'. Make sure that Windows Firewall on the 'Basic' tab is set to On. 2. Click the 'Exceptions' tab and 'Add port' button. 3. Enter any name, port number (54295 for network scanning and 54926 for network PC-Fax receiving), select 'UDP' and click 'OK'. 4. Make sure if the new setting is added and is checked, and then click 'OK'. <p>For Windows® XP SP1 users, please visit the Brother Solutions Center.</p>
Your computer cannot find your machine.	<p><For Windows® user></p> <p>Firewall setting on your PC may be rejecting the necessary network connection. For detail, see the instruction above.</p> <p><For Macintosh® users></p> <p>Re-select your machine in the DeviceSelector application located in Macintosh HD/Library/Printers/Brother/Utilities or from the mode I of ControlCenter2.</p>
Other Difficulties	
Incorrect LCD language	See <i>How to change LCD language</i> on page 6-10.
I cannot see the LCD clearly.	Change the contrast settings. (See <i>How to improve the LCD viewing</i> on page 6-10.)







How to change LCD language

You can change the LCD language.

- 1 Press **Menu**.
- 2 Press  or  to select 0.Initial Setup.
Press **Set**.
- 3 Press  or  to select 0.Local Language.
Press **Set**.
- 4 Press  or  to select your language.
Press **Set**.
- 5 Press **Stop/Exit**.







How to improve the LCD viewing

You can adjust the LCD contrast for a sharper and more vivid display. If you are having difficulty seeing the LCD from your position, try to change the contrast settings for improved viewing.

- 1 Press **Menu**.
- 2 Press  or  to select 0.Initial Setup.
Press **Set**.
- 3 Press  or  to select 2.LCD Contrast.
Press **Set**.
- 4 Press  or  to select Dark (or Light).
Press **Set**.
- 5 Press **Stop/Exit**.

Setting the Beeper Volume

You can change the beeper volume. The default (factory) setting is Low. When the beeper is on, the machine will beep when you press a key or make a mistake.

- 1 Press **Menu**.
- 2 Press  or  to select 0.Initial Setup.
Press **Set**.
- 3 Press  or  to select 3.Volume.
Press **Set**.
- 4 Press  or  to select your option.
(Low, Med, High or Off)
Press **Set**.
- 5 Press **Stop/Exit**.

How to improve print quality

Cleaning the print head





To ensure good print quality, the machine will regularly clean the print head. You can start the cleaning process manually if needed.

Clean the print head and ink cartridges if you get a horizontal line in the text or graphics on your printed pages. You can clean Black only or three colours at a time (Cyan/Yellow/Magenta), or all four colours at once.

Cleaning the print head consumes ink. Cleaning too often uses ink unnecessarily.

Caution

Do NOT touch the print head. Touching the print head may cause permanent damage and may void the print head's warranty.

- 1 Press  (**Ink Management**).
- 2 Press  or  to select **Cleaning**.
Press **Set**.
- 3 Press  or  to select **Black, Color or All**.
Press **Set**.





The machine will clean the print head. When cleaning is finished, the machine will go back to standby mode automatically.



If you clean the print head at least five times and the print has not improved, call your Brother dealer for service.

Checking the print quality

If faded or streaked colours and text appears on your output, some of the nozzles may be clogged. You can check this by printing the Print Quality Check Sheet and looking at the nozzle check pattern.

- 1 Press  (**Ink Management**).
- 2 Press  or  to select **Test Print**.
Press **Set**.
- 3 Press  or  to select **Print Quality**.
Press **Set**.
- 4 Press **Colour Start**.
The machine begins printing the Print Quality Check Sheet.
- 5 Follow the instructions given on the sheet to see if the quality is OK.

Colour block quality check

The LCD shows:

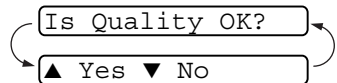

- 6 Check the quality of the four colour blocks on the sheet.
- 7 If all lines are clear and visible, press  (**Yes**) and go to Step 10.

—OR—

If you can see missing short lines as shown below, press  (**No**).

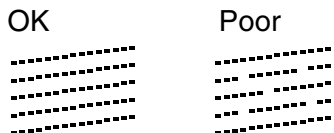

The LCD will ask you if the print quality is OK for black and three colours.

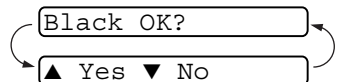

- 8 Press **▼** (No) for black or three colours with a problem.

The LCD shows:

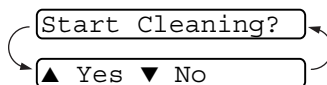

Press **▲** (Yes). The machine will start cleaning the print head.

- 9 After cleaning is finished, press **Colour Start**. The machine will start printing the Print Quality Check Sheet again and then return to Step 5.

- 10 Press **Stop/Exit**.

If you still see missing ink in this Print Quality Check Sheet, repeat the cleaning and test print procedures at least five times. If ink is still missing after the fifth cleaning and test print, replace the ink cartridge for the clogged colour. (Perhaps the ink cartridge was in your machine over six months or the expiration date written on the cartridge package has passed. Or, the ink may not have been stored properly before use.)

After replacing the ink cartridge, check it by printing another Print Quality Check Sheet. If the problem still exists, repeat the cleaning and test print procedures at least five times for the new ink cartridge. If ink is still missing, call your Brother dealer for service.

Caution

Do NOT touch the print head. Touching the print head may cause permanent damage and may void the print head's warranty.







When a print head nozzle is clogged the printed sample looks like this.



When the print head nozzle is cleaned, the horizontal lines are gone.

Checking the printing alignment

You should rarely need to adjust the printing alignment however, if after transporting the machine your printed text becomes blurred or images become faded then adjustment may need to be made.

- 1 Press  (**Ink Management**).
- 2 Press  or  to select `Test Print`.
Press **Set**.
- 3 Press  or  to select `Alignment`.
Press **Set**.
- 4 Press **Mono Start** or **Colour Start**.

The machine begins printing the Alignment Check Sheet.

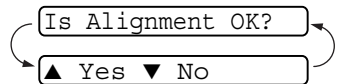

The LCD shows:



- 5 Check the 600 dpi and 1200 dpi test prints to see if number 5 most closely matches number 0. If the number 5 sample of both the 600 dpi and 1200 dpi are the best matches, press  (**Yes**) to finish Alignment Check and go to Step 8.

—OR—



If another test print number is a better match for either 600 dpi or 1200 dpi, press  (**No**) to select it.

- 6 For 600 dpi, press  or  to select the number of the test print that most closely matches the number 0 sample (1-8).

600dpi Adjust

Select Best #5

Press **Set**.

- 7 For 1200 dpi, press  or  to select the number of the test print that most closely matches the number 0 sample (1-8).

1200dpi Adjust

Select Best #5



Press **Set**.

- 8 Press **Stop/Exit**.

Checking the ink volume



You can check the ink that is left in the cartridge.

1 Press  (**Ink Management**).

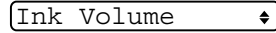
2 Press  or  to select Ink Volume.



Press **Set**.

3 Press  or  to select the colour you want to check.

The LCD shows the ink volume.



4 Press **Stop/Exit**.



You can check the ink volume from your computer. (For Windows[®] users, see Chapter 1 in Software User's Guide on the CD-ROM or for Macintosh[®] users, see Chapter 8 in Software User's Guide on the CD-ROM.)

Packing and shipping the machine

Whenever you transport the machine, use the packing materials that came with your machine. If you do not pack the machine properly, you could void your warranty.

! Caution

It is important to allow the machine to 'park' the print head after a print job. Listen carefully to the machine before disconnecting it from the power source to ensure that all mechanical noise has stopped. Not allowing the machine to complete this parking process may lead to print problems and possible damage to the print head.

- 1 Lift the scanner cover from the right-hand side of the machine until it locks securely into the open position.
- 2 Remove all the ink cartridges and attach the yellow protective parts. (See *Replacing the ink cartridges* on page 6-22.)

When attaching the yellow protective parts, make sure they clip into place as shown in the diagram.

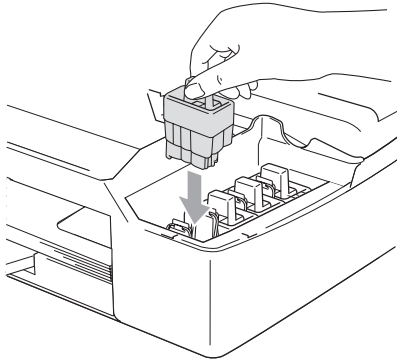

! Caution

If you are not able to find the yellow protective parts, do NOT remove the ink cartridges before shipping. It is essential that the machine be shipped with the yellow protective parts or the ink cartridges in position. Shipping without them will cause damage to your machine and may void your warranty.

- 3** Lift the scanner cover to release the lock. Gently push the scanner cover support down and close the scanner cover.

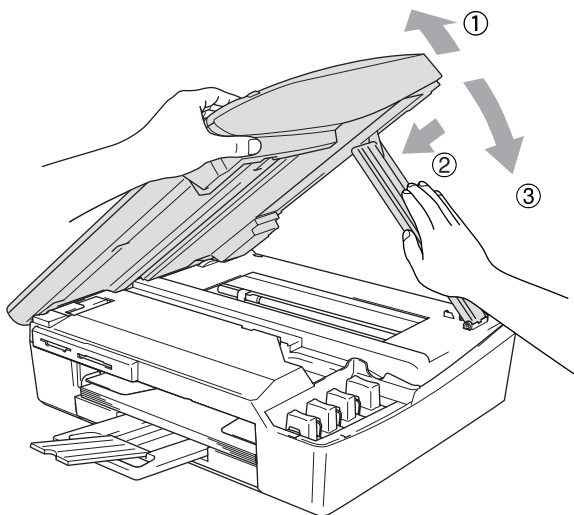

- 4** Unplug the machine from the electrical socket.
5 Unplug the interface cable from the machine, if it is connected.
6 Wrap the machine in the bag and place it in the original carton with the original packing material.

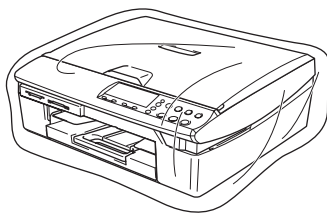

- 7** Pack the printed materials in the original carton as shown below.
Do not pack the used ink cartridges in the carton.

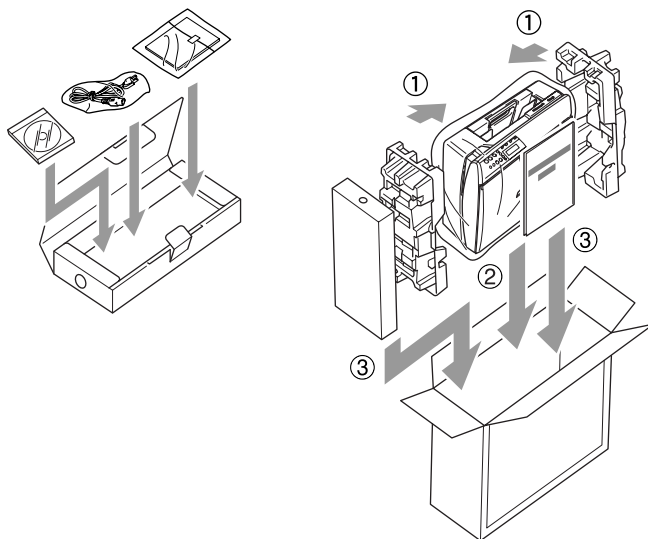

- 8** Close the carton.

Routine maintenance

Cleaning the scanner

Lift the document cover. Clean the scanner glass with isopropyl alcohol on a soft lint-free cloth.

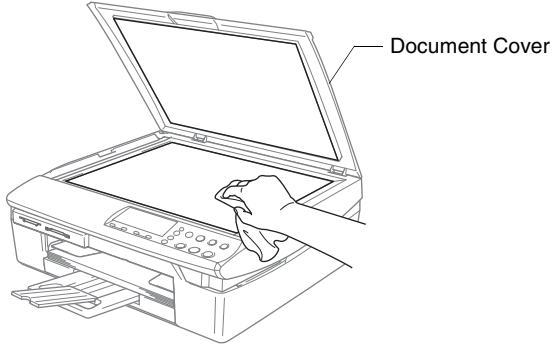

Clean the glass strip under the film with isopropyl alcohol on a lint-free cloth.

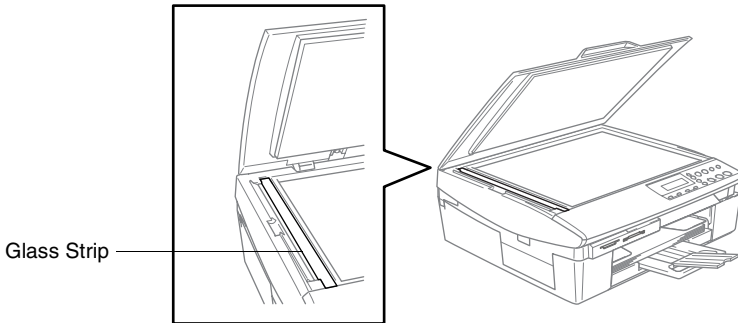

Cleaning the machine printer platen

- Be careful not to touch the paper feed star wheels or encoder film.
- Be sure to unplug the machine from the electrical socket before cleaning the printer platen.
- If ink is scattered on or around the printer platen be sure to wipe it off with a soft, dry, lint-free cloth.

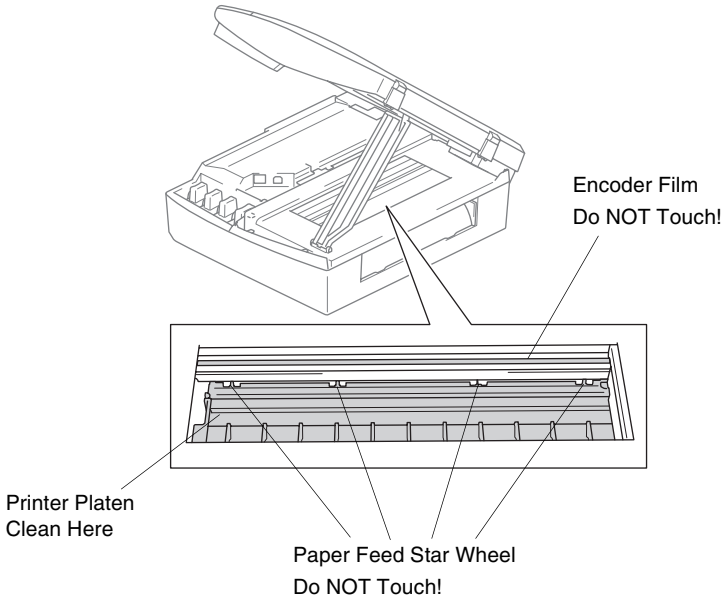

Cleaning the Paper Pick-up Roller

- 1 Unplug the machine from the electrical socket and remove the Jam Clear Cover.

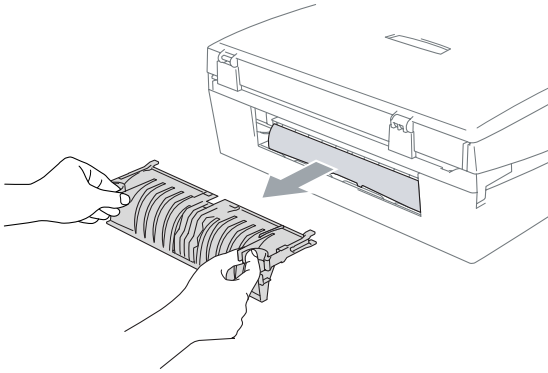

- 2 Clean the Paper Pick-up Roller with isopropyl alcohol on a cotton swab.

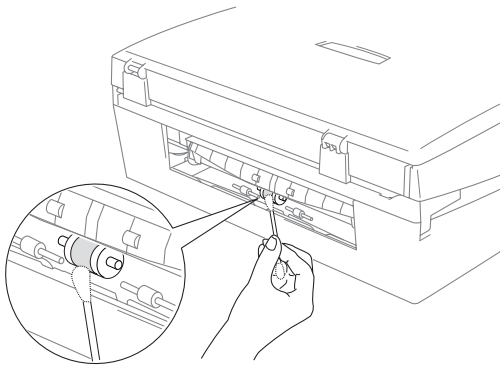

- 3 Re-insert the Jam Clear Cover.
- 4 Re-connect the power cord.

Replacing the ink cartridges

Your machine is equipped with an ink dot counter. The ink dot counter automatically monitors the level of ink in each of the four cartridges. When the machine detects an ink cartridge is running out of ink, the machine will notify you with a message on the LCD.

The LCD will inform you which ink cartridge is low or needs replacing. Be sure to follow the LCD prompts to replace the ink cartridges in the correct order.

Even though the machine informs you that an ink cartridge is empty, there will be a small amount of ink remaining in the ink cartridge. It is necessary to keep some ink in the ink cartridge to prevent air from drying out and damaging the print head assembly.

- 1** Lift the scanner cover from the right-hand side of the machine until it locks securely into the open position.

If one or more ink cartridges are empty, for example Black, the LCD shows **Ink Empty Black** and **Replace Ink**.

- 2** Pull the ink cartridge hook toward you and remove the ink cartridge for the colour shown on the LCD.

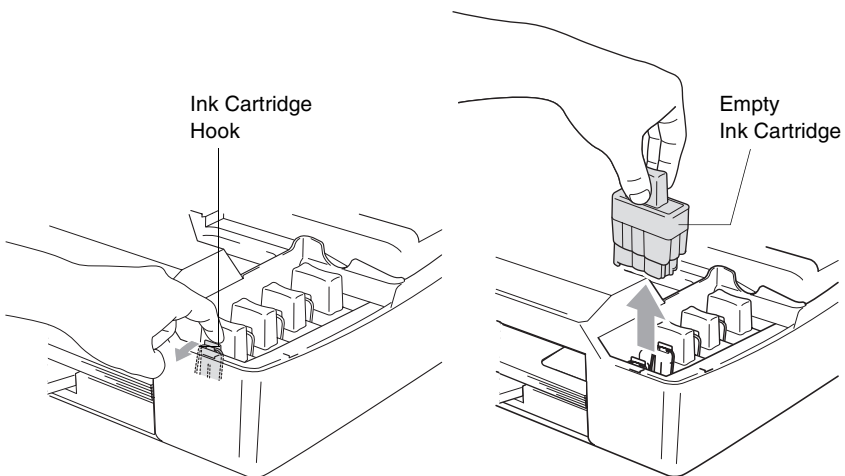

- 3** Open the new ink cartridge bag for the colour shown on the LCD, and then take out the ink cartridge.

4 Remove the protective yellow caps.

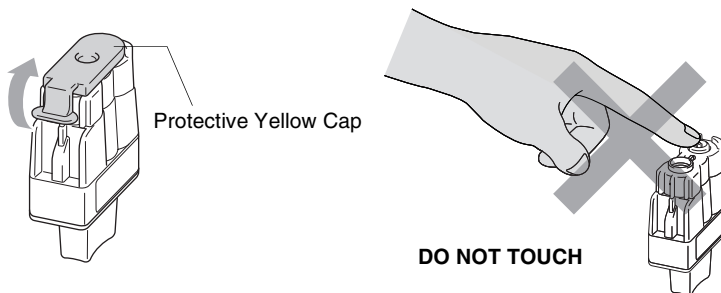

⊘ Do not touch the area shown in the illustration above.

 If the protective yellow cap comes off when you open the bag, the cartridge will not be damaged.

5 Each colour has its own correct position. Keep the ink cartridge in an upright position when you insert it into the slot. Press down firmly on the ink cartridge until the hook snaps over it.

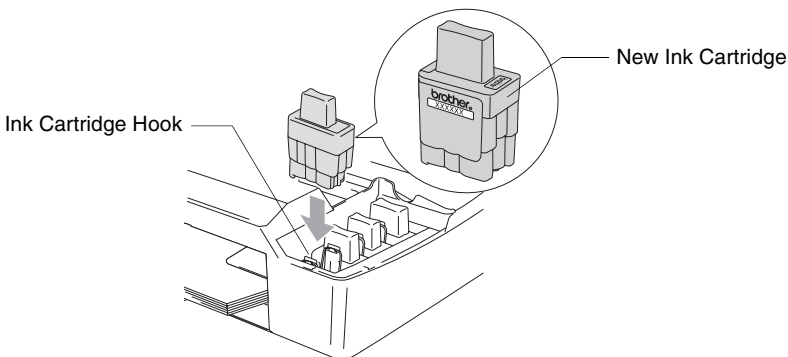

6 Lift the scanner cover to release the lock. Gently push the scanner cover support down and close the scanner cover.

7 If you replaced an ink cartridge while *Near Empty* was displayed on the LCD, the LCD may ask you to verify that it was a brand new one. Example: *Did You Change Black?* ▲ Yes ▼ No. For each *new* cartridge you installed, press ⬆ (Yes) to automatically reset the ink dot counter for that colour. If the ink cartridge you installed is not a brand new one, please be sure to select ⬇ (No).

 If you wait until *Ink Empty* message is displayed on the LCD, the machine will automatically reset the ink dot counter.

 If the *Install* message is on the display after you have installed ink cartridges, check that the ink cartridges are installed properly.

 **WARNING**

If ink gets in your eyes, irrigate them with water immediately and call a doctor if you are concerned.

Caution

- Do not remove ink cartridges if you do not need to replace them. If you do so, it may reduce the ink quantity and the machine will not know the quantity of ink left in the cartridge.
- Do not touch the cartridge insertion slots. If you do so, the ink may stain your skin.
- If ink stains your skin or clothing, wash with soap or detergent immediately.
- If you install an ink cartridge in the wrong colour position, you must clean the print head several times before you start printing (after correcting the cartridge installation) because the colours were mixed.
- Once you open an ink cartridge, install it in the machine and use it up within six months of installation. Use unopened ink cartridges by the expiration date written on the cartridge package.
- Do not dismantle or tamper with the ink cartridge, this can cause the ink to leak out of the cartridge.
- Brother multifunction machines are designed to work with ink of a particular specification and work to a level of optimum performance when used with genuine Brother ink cartridges. Brother cannot guarantee this optimum performance if ink or ink cartridges of other specifications are used. Brother does not therefore recommend the use of cartridges other than genuine Brother cartridges with this machine or the refilling of empty cartridges with ink from other sources. If damage is caused to the print head or other parts of this machine as a result of the use of ink or ink cartridges other than genuine Brother products due to the incompatibility or lack of suitability of those products with this machine, any repairs required as a result will not be covered by the warranty.

A Appendix

On-screen programming

Your machine is designed to be easy to use with LCD on-screen programming. User-friendly programming helps you take full advantage of all the menu selections your machine has to offer.

Since your programming is done on the LCD, we have created step-by-step on-screen instructions to help you program your machine. All you need to do is follow the instructions as they guide you through the menu selections and programming options.

Menu table

You can probably program your machine without the User's Guide if you use the Menu table that begins on page A-3. These pages will help you understand the menu selections and options that are found in the machine's programs.

Printing reports

The following reports are available.

- | | |
|--------------------------------------|--|
| 1.Help List | Prints the Help List so you can see at-a-glance how to quickly program your machine. |
| 2.User Settings | Lists your settings. |
| 3.Network Config
(DCP-315CN only) | Lists your Network settings. |

1 Press **Menu**.

2 Press **▲** or **▼** to select Print Reports.

Press **Set**.

3 Press **▲** or **▼** to select the report you want.

Press **Set**.

4 Press **Mono Start**.

Menu keys

	Menu	Access the menu
	+ -	Scroll through the current menu level
	Set	Accept an option Go to the next menu level
	Stop/Exit	Exit the menu

You can access the menu mode by pressing **Menu**.
When you enter the menu, the LCD scrolls.

- 1.Copy
- 2.PhotoCapture
- ⋮
- 0.Initial Setup

You can scroll more quickly through each menu level by pressing the arrow for the direction you want: or .

Select an option by pressing **Set** when that option appears on the LCD.

The LCD will then show the next menu level.

Press or to scroll to your next menu selection.

Press **Set**.

When you finish setting an option, the LCD shows *Accepted*.

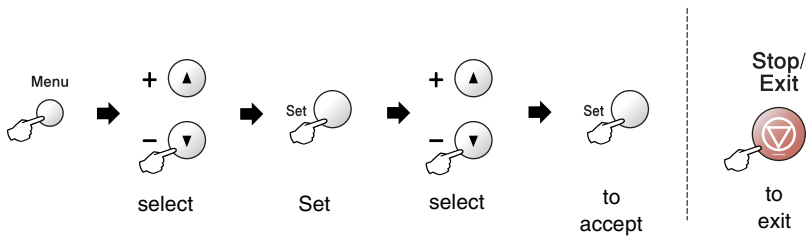

Main Menu	Submenu	Menu Selections	Options	Descriptions	Page
1.Copy	1.Paper Type	—	Plain Inkjet Glossy Transparency	Sets the type of paper in the paper tray.	2-12
	2.Paper Size	—	Letter Legal A4 A5 10x15cm	Sets the size of the paper in the paper tray.	2-13
	3.Quality	—	Best Normal Fast	Selects the Copy resolution for your type of document.	2-13
	4.Brightness	—	- □□□□ ■ + - □□□□ ■ + - □□□□ ■ + - □□□□ ■ + - ■□□□□ +	Adjusts the brightness.	2-14
	5.Contrast	—	- □□□□ ■ + - □□□□ ■ + - □□□□ ■ + - □□□□ ■ + - ■□□□□ +	Adjusts the contrast for copies.	2-14



The factory settings are shown in Bold.

Main Menu	Submenu	Menu Selections	Options	Descriptions	Page
1.Copy (Continued)	6.Color Adjust	1.Red	R:- o o o o ■ + R:- o o o o ■ + R:- o o o o + R:- o ■ o o o + R:- ■ o o o o +	Adjusts the amount of Red in copies.	2-15
		2.Green	G:- o o o o ■ + G:- o o o o ■ + G:- o o o o + G:- o ■ o o o + G:- ■ o o o o +	Adjusts the amount of Green in copies.	
		3.Blue	B:- o o o o ■ + B:- o o o o ■ + B:- o o o o + B:- o ■ o o o + B:- ■ o o o o +	Adjusts the amount of Blue in copies.	
2.PhotoCapture	1.Print Quality	—	Normal Photo	Selects the print quality.	3-9
	2.Paper & Size	—	Letter Glossy 10x15cm Glossy 13x18cm Glossy A4 Glossy Letter Plain A4 Plain Letter Inkjet A4 Inkjet 10x15cm Inkjet	Selects the paper and print size.	3-9
	3.Brightness	—	- o o o o ■ + - o o o o ■ + - o o o o ■ + - o o o o + - ■ o o o o +	Adjusts the brightness.	3-10
	4.Contrast	—	- o o o o ■ + - o o o o ■ + - o o o o ■ + - o o o o + - ■ o o o o +	Adjusts the contrast.	3-10



The factory settings are shown in Bold.

Main Menu	Submenu	Menu Selections	Options	Descriptions	Page
2.PhotoCapture (Continued)	5.Color Enhance	Enhance:On Enhance:Off	1.White Balance - o o o o ■ + - o o o ■ o + - o o ■ o o + - o ■ o o o + - ■ o o o o +	Adjusts the hue of the white areas.	3-11
			2.Sharpness - o o o o ■ + - o o o ■ o + - o o ■ o o + - o ■ o o o + - ■ o o o o +	Enhances the detail of the image.	
			3.Color Density - o o o o ■ + - o o o ■ o + - o o ■ o o + - o ■ o o o + - ■ o o o o +	Adjusts the total amount of colour in the image.	
	6.Cropping	—	On Off	Crops the image around the margin to fit the paper size or print size. Turn this feature Off if you want to print whole images or prevent unwanted cropping.	3-12
7.Borderless	—	On Off	Expands the printable area to fit the edges of the paper.	3-13	
8.Scan to Card	1.Quality	B/W 200x100 dpi B/W 200 dpi Color 150 dpi Color 300 dpi Color 600 dpi	Selects the Scan resolution for your type of document.	3-13	
	2.B/W File Type	TIFF PDF	Selects the default file format for black and white scanning.		
	3.ColorFile Type	PDF JPEG	Selects the default file format for colour scanning.		



The factory settings are shown in Bold.

Main Menu	Submenu	Menu Selections	Options	Descriptions	Page
3.LAN (DCP-315CN only)	1.Setup TCP/IP	1.BOOT Method	Auto Static RARP BOOTP DHCP	You can select the BOOT method that best suits you needs.	See Network User's Guide on the CD-ROM
		2.IP Address	[000-255]. [000-255]. [000-255]. [000-255]	Enter the IP address.	
		3.Subnet Mask	[000-255]. [000-255]. [000-255]. [000-255]	Enter the Subnet mask.	
		4.Gateway	[000-255]. [000-255]. [000-255]. [000-255]	Enter the Gateway address.	
		5.Node Name	BRN_XXXXXX	You can confirm the Node name.	
		6.WINS Config	Auto Static	You can select the WINS configuration mode.	
		7.WINS Server	(Primary) 000.000.000.000 (Secondary) 000.000.000.000	Specifies the IP address of the primary or secondary server.	
		8.DNS Server	(Primary) 000.000.000.000 (Secondary) 000.000.000.000	Specifies the IP address of the primary or secondary server.	
	9.APIPA	On Off	Automatically allocates the IP address from the link-local address range.		
		2.Setup Misc.	1.Ethernet	Auto 100B-FD 100B-HD 10B-FD 10B-HD	
	0.Factory Reset	—	—	Restore all network settings to factory default.	



The factory settings are shown in Bold.

Main Menu	Submenu	Menu Selections	Options	Descriptions	Page
3.Print Reports (DCP-115C, 116C, 120C only) 4.Print Reports (DCP-315CN only)	1.Help List	—	—	You can print these lists and reports.	A-1
	2.User Settings	—	—		
	3.Network Config (DCP-315CN only)	—	—		
0.Initial Setup	1.Date/Time	—	—	Puts the date and time in your machine.	See Quick Setup Guide
	2.LCD Contrast	—	Light* ¹ Dark	Adjusts the contrast of the LCD.	6-10
	3.Volume	—	High Med Low Off	Adjusts the volume level of the beeper.	6-10
	0.Local Language	—	English French German Dutch Italian	Allows you to change the LCD Language for your country.	6-10



The factory settings are shown in Bold.

*¹It depends on your machine.

S Specifications

Product description

General

Memory Capacity	8 MB (DCP-115C, DCP-116C, DCP-120C) 16 MB (DCP-315CN)
Automatic Document Feeder (ADF) (DCP-120C only)	Up to 10 pages
Paper Tray	100 Sheets (80 gsm)
Printer Type	Ink Jet
Print Method	Piezo with 74 x 5 nozzles
LCD (Liquid Crystal Display)	16 characters x 1 line (DCP-115C, DCP-116C, DCP-120C) 16 characters x 2 lines (DCP-315CN), Back light
Power Source	220 - 240V 50/60Hz
Power Consumption	(DCP-115C, DCP-116C) Power Save Mode: Average 2.5 W Standby: Average 6.5 W Operating: Average 16 W (DCP-120C) Power Save Mode: Average 3 W Standby: Average 8 W Operating: Average 21 W (DCP-315CN) Power Save Mode: Average 3.5 W Standby: Average 8 W Operating: Average 17 W

Dimensions

(DCP-115C, DCP-116C, DCP-315CN)

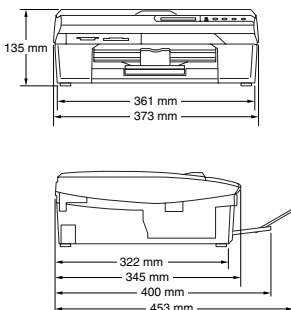

(DCP-120C)

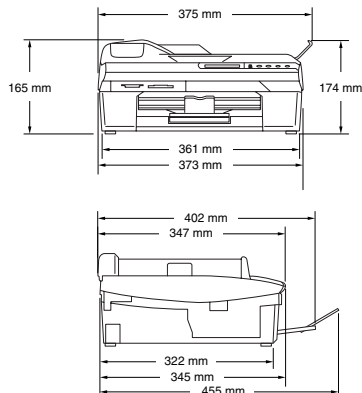

Weight	5.5 kg (DCP-115C, DCP-116C, DCP-315CN) 6.0 kg (DCP-120C)
Noise	Operating: 42.5 to 51 dB* * It depends on printing conditions
Temperature	Operating: 10 - 35°C Best Print Quality: 20 - 33°C
Humidity	Operating: 20 to 80% (without condensation) Best Print Quality: 20 to 80% (without condensation)

Print media

Paper Input

Paper Tray

- Paper type:
Plain paper, inkjet paper (coated paper), glossy paper*², transparencies*^{1*2} and envelopes
- Paper size:
Letter, Legal*³, Executive, A4, A5, A6, JIS_B5, envelopes (commercial No.10, DL, C5, Monarch, JE4), Photo card, Index card, Post Card.
For more details, see *Paper type and size for each operation* on page 1-10.
- Maximum paper tray capacity: Approx. 100 sheets of 80 gsm plain paper

Paper Output

Up to 25 sheets of A4 plain paper (Face up print delivery to the output paper tray)*²

*¹ Use only transparencies recommended for inkjet printing.

*² For glossy paper and transparencies, we recommend removing printed pages from the output paper tray immediately after they exit the machine to avoid smudging.

*³ Legal paper cannot be stacked on the output paper tray.

Copy

Colour/Black

Copy Speed

Colour/Black

Black

Up to 17 pages/minute (A4 paper)*

Colour

Up to 11 pages/minute (A4 paper)*

* Does not include the time it takes to feed the paper.

Based on Brother standard pattern. (Fast mode)

Copy speeds vary with the complexity of the document.

Multiple Copies

Stacks up to 99 pages

Sorts up to 99 pages (DCP-120C only)

Enlarge/Reduce

25% to 400% (in increments of 1%)

Resolution

Plain, inkjet or glossy paper:

(Monochrome)

■ Scans up to 1200 x 1200 dpi

■ Prints up to 1200 x 1200 dpi

(Colour)

■ Scans up to 600 x 1200 dpi

■ Prints up to 600 x 1200 dpi

OHP/Transparency:

■ Scans up to 600 x 600 dpi

■ Prints up to 1200 x 1200 dpi

Document Size (DCP-115C, DCP-116C, DCP-315CN)

Scanner Glass Width: Max. 216 mm

Scanner Glass Height: Max. 297 mm

Document Size (DCP-120C)

ADF Width: 147 mm to 216 mm

ADF Height: 147 mm to 356 mm

Scanner Glass Width: Max. 216 mm

Scanner Glass Height: Max. 297 mm

Scanning Width

210 mm

PhotoCapture Center™

Available Media

CompactFlash®
(Type I only)
(Microdrive™ is not compatible)
(Compact I/O card such as Compact LAN card
and Compact Modem card are not supported.)
SmartMedia® (3.3V)
(Not available for use with ID)
Memory Stick®
Memory Stick Pro™
(Not available for music data with MagicGate™)
SecureDigital™
MultiMediaCard™
xD-Picture Card™
* xD-Picture Card™ Type M support

File Extension

(Media Format)

(Image Format)

DPOF, EXIF, DCF
Photo Print: JPEG*
Scan to Card: JPEG, PDF (Colour)
TIFF, PDF (Black)

* Progressive JPEG format is not supported.

Number of Files

Up to 999 files in the media card

Folder

Files must be in the 3rd folder level of the media
card.

Borderless

A4, Letter, Photo Card

Scanner

Colour/Black	Colour/Black
TWAIN Compliant	Yes (Windows® 98/98SE/Me/2000 Professional/XP) Mac OS® 9.1-9.2/Mac OS® X 10.2.4 or greater.
WIA Compliant	Yes (Windows® XP)
Colour Depth	36 bit colour processing (Input) 24 bit colour processing (Output)
Resolution	Up to 19200 × 19200 dpi (interpolated) Up to 600 × 2400 dpi (optical)
Scanning Speed	Colour: up to 5.93 sec. Black: up to 3.76 sec. (A4 size in 100 × 100 dpi)
Document Size (DCP-115C, DCP-116C, DCP-315CN)	Scanner Glass Width: Max. 216 mm Scanner Glass Height: Max. 297 mm
Document Size (DCP-120C)	ADF Width: 147 mm to 216 mm ADF Height: 147 mm to 356 mm Scanner Glass Width: Max. 216 mm Scanner Glass Height: Max. 297 mm
Scanning Width	210 mm
Gray Scale	256 levels

Printer

Printer Driver	Windows® 98/98SE/Me/2000 Professional and XP driver supporting Brother Native Compression mode and bi-directional capability Brother Ink Driver For Mac OS® 9.1-9.2/Mac OS® X 10.2.4 or greater
Resolution	Up to 1200 x 6000 dots per inch (dpi)* 1200 x 1200 dots per inch (dpi) 600 x 600 dots per inch (dpi) 600 x 150 dots per inch (dpi) <small>* Output image quality varies based upon many factors including but not limited to input image resolution and quality and print media.</small>
Print Speed	(DCP-115C, DCP-120C, DCP-315CN) up to 20 pages/minute (Black)* up to 15 pages/minute (Colour)* (DCP-116C) up to 18 pages/minute (Black)* up to 13 pages/minute (Colour)* <small>* Based on Brother standard pattern. A4 size in draft mode. Does not include the time it takes to feed the paper.</small>
Printing Width	204 mm (216mm)* <small>* When you set the Borderless feature to On.</small>
Disk-Based Fonts	35 TrueType Font bundled with the CD-ROM
Borderless	Letter, A4, A6, Photo Card, Index Card, Post Card, Envelope

Interfaces

USB	A full-Speed USB 2.0 cable that is no longer than 2.0 m.*
LAN Cable (DCP-315CN only)	Ethernet UTP cable category 5 or greater <small>* Your machine has a Full-Speed USB 2.0 interface. This interface is compatible with Hi-Speed USB 2.0; however, the maximum data transfer rate will be 12 Mbits/s. The machine can also be connected to a computer that has a USB 1.1 interface.</small>

Computer requirements

Minimum System Requirements						
Computer Platform & Operating System Version		Minimum Processor	Minimum RAM	Recommended RAM	Available Hard Disk Space	
					for Drivers	for Applications
Windows® Operating System	98, 98SE	Pentium II or equivalent	32 MB	64 MB	90 MB	130 MB
	Me		64 MB	128 MB		
	2000 Professional		128 MB	256 MB	150 MB	220 MB
	XP	Athlon®64 Opteron Xeon® & Pentium®4 including Intel EM64T	256 MB	512 MB	150 MB	220 MB
Apple® Macintosh® Operating System	Mac OS® 9.1-9.2(Printing, Scanning*1 and Removable Disk)	All base models meet minimum Requirements		64 MB	80 MB	200 MB
	Mac OS® X 10.2.4 or greater	128 MB	160 MB			
NOTE: All registered trademarks referenced herein are the property of their respective companies.						
For the latest drivers updates, see the Brother Solutions Center at http://solutions.brother.com						

*1 Dedicated “Scan” key and direct Network Scanning (DCP315CN) supported in Mac® Operating Systems Mac OS® X 10.2.4 or greater.

Consumable items

Ink

The machine uses individual Black, Yellow, Cyan and Magenta ink cartridges that are separate from the print head assembly.

Service Life of Ink Cartridge

Black - Approximately 500 pages at 5% coverage
Yellow, Cyan and Magenta - Approximately 400 pages at 5% coverage

- The above figures assume continuous printing at a resolution of 600 x 600 dpi in normal mode after installing new ink cartridge.
- The number of pages a cartridge will print may change depending on how often you use the machine and how many pages you print with each use.
- The machine will automatically and periodically clean the print head assembly, a process that uses a small amount of ink.
- The first time you install a set of ink cartridges the machine will use a small amount of ink to fill and prime the ink delivery tubes. This process will only happen once.
- When the machine identifies a cartridge as empty there may be a small amount of ink left in it. This is necessary to prevent air from drying out and damaging the print head assembly.

Replacement Consumables

<Standard Black> LC47BK
<Cyan> LC47C
<Magenta> LC47M
<Yellow> LC47Y

Network (LAN) (DCP-315CN only)

LAN

You can connect your machine to a network for Network Printing, Network Scanning. Also included is Brother BRAdmin Professional Network Management software.

Support for:

Windows® 98/98SE/Me/2000/XP
Mac OS® 9.1-9.2, Mac OS® X 10.2.4 or greater
Ethernet 10/100 BASE-TX Auto Negotiation

Protocols

TCP/IP
ARP, RARP, BOOTP, DHCP, APIPA, NetBIOS, WINS, LPR/LPD, Port9100, mDNS, FTP, TELNET, SNMP, TFTP, Scanner port

Included Utilities:

BRAdmin Professional (Windows®)



- BRAdmin Professional is not supported in Mac OS®.
- BRAdmin Light is available for Mac OS® X 10.2.4 or greater users.
For more information, please visit the Brother Solutions Center (<http://solutions.brother.com>)
- Network Scanning is available for Mac OS® X 10.2.4 or greater.

Index

- A**
- ADF (automatic document feeder) 1-5
 - ADF cover 6-3
- C**
- Cleaning
 - Paper Pick-up Roller 6-21
 - print head 6-11
 - printer platen 6-20
 - scanner 6-19
 - Computer requirements S-7
 - Consumable items S-8
 - Control panel overview 1-2
 - Copy
 - brightness 2-8
 - Colour adjustment 2-15
 - contrast 2-14
 - default settings 2-12
 - Enlarge/Reduce 2-4
 - keys 2-2
 - multiple 2-1
 - Page Layout 2-9
 - paper 2-7
 - Quality key 2-3
 - quality setting 2-13
 - single copy 2-1
 - Sort (ADF only) 2-8
 - temporary settings 2-2
- E**
- Envelopes 1-12
 - Error messages on LCD 6-1
 - Ink Empty 6-1
 - No Paper Fed 6-2
 - Out of Memory 6-2
 - Unable to Change 6-2
 - Unable to Clean 6-2
 - Unable to Init. 6-2
 - Unable to Print 6-2
 - Unable to Scan 6-2
- G**
- Gray scale S-5
- H**
- HELP
 - Help List A-1
 - Menu Table using
 - Menu keys A-2
- I**
- Ink cartridges
 - checking ink volume 6-15
 - Ink Dot Counter 6-22
 - replacing 6-22
- J**
- Jams
 - document 6-3
 - paper 6-4
- L**
- LCD
 - improve viewing 6-10
- M**
- Maintenance, routine 6-19
 - Menu Selection Table A-1
- O**
- Options key (copying)
 - Brightness 2-8
 - Paper Size 2-7
 - Paper Type 2-7

P

- Paper 1-8, S-2
 - Size 2-13
 - size of document 1-5
 - Type 2-12
- PhotoCapture 3-1
- PhotoCapture Center™
 - Borderless 3-13
 - Colour enhancement 3-11
 - CompactFlash® 3-1
 - Cropping 3-12
 - Default Settings 3-9
 - DPOF printing 3-8
 - Memory Stick® 3-1
 - MultiMediaCard™ 3-1
 - paper and size 3-9, 3-15
 - Printing images 3-6
 - Printing Index 3-5
 - quality 3-14
 - SmartMedia® 3-1
 - specifications S-4
 - xD-Picture Card™ 3-1
- Print
 - area 1-12
 - difficulties 6-7
 - drivers S-6
 - improving quality 6-11
 - resolution S-6
 - specifications S-6

Q

- Quality key (copying) 2-2

R

- Reducing
 - copies 2-4
- Reports
 - Help List A-1
 - how to print A-1
 - Network Configuration A-1

- User Settings A-1
- Resolution
 - copy S-3
 - print S-6
 - scan S-5

S

- Safety Instructions 5-2
- Shipping the machine 6-16

T

- Temporary copy settings 2-2
- Troubleshooting 6-1
 - checking ink volume 6-15
 - document jam 6-3
 - error messages on LCD ... 6-1
 - if you are having difficulty
 - Copying Difficulties 6-8
 - Network Difficulties 6-9
 - PhotoCapture Center™
 - Difficulties 6-8
 - Printing Difficulties 6-7
 - Scanning Difficulties 6-8
 - Software Difficulties 6-8
 - print quality 6-11

For Australia

Warranty – For details about the warranty on your Brother Product, please visit: www.brother.com.au

Repair – For warranty service for your Brother Product you will need evidence of original purchase (e.g. a copy of the sales docket).

Contact Brother International (Aust) Pty Ltd for details about your nearest Authorised Warranty Centre or visit: www.brother.com.au.

Support – For support for your Brother Product other than what you can resolve through the User Guide,

Visit our website: www.brother.com.au

or visit our Solutions website for FAQs (Frequently Asked Questions), Driver Updates & Utilities, Product Support: <http://solutions.brother.com>.

You can contact the Product Support Centre for any technical or customer care/support enquiry you may have about your Brother Product.

Product Support Centre - Australia

Brother International (Aust) Pty Ltd

Phone: 02 8875 6000 Fax: 02 9870 7223

email: productsupport@brother.com.au

<http://www.brother.com.au>

brother[®]

**Visit us on the World Wide Web
<http://www.brother.com>**

ARL/ASANZ

Free Manuals Download Website

<http://myh66.com>

<http://usermanuals.us>

<http://www.somanuals.com>

<http://www.4manuals.cc>

<http://www.manual-lib.com>

<http://www.404manual.com>

<http://www.luxmanual.com>

<http://aubethermostatmanual.com>

Golf course search by state

<http://golfingnear.com>

Email search by domain

<http://emailbydomain.com>

Auto manuals search

<http://auto.somanuals.com>

TV manuals search

<http://tv.somanuals.com>