

At your side.
brother®

USER'S GUIDE

FAX-T98



At your side.
brother®

THIS EQUIPMENT IS DESIGNED TO WORK WITH A TWO WIRE ANALOGUE PSTN LINE FITTED WITH THE APPROPRIATE CONNECTOR.

APPROVAL INFORMATION

Brother advises that this product may not function correctly in a country other than where it was originally purchased, and does not offer any warranty in the event that this product is used on public telecommunication lines in another country.

Compilation and Publication Notice

Under the supervision of Brother Industries Ltd., this manual has been compiled and published, covering the latest product descriptions and specifications.

The contents of this manual and the specifications of this product are subject to change without notice.

Brother reserves the right to make changes without notice in the specifications and materials contained herein and shall not be responsible for any damages (including consequential) caused by reliance on the materials presented, including but not limited to typographical and other errors relating to the publication.



EC Declaration of Conformity under the R & TTE Directive

Manufacturer

Brother Industries, Ltd.,
15-1, Naeshiro-cho, Mizuho-ku,
Nagoya 467-8561, Japan

Plant

Brother Industries (Johor) Sdn. Bhd.
No.6 Jalan Firma 1,
Kawasan Perindustrian Tebrau,
81100 Johor Bahru, Johor Darul, Takzim, Malaysia

Herewith declare that:

Products description : Facsimile Machine
Type : Group 3
Model Name : FAX-T98

are in conformity with provisions of the R & TTE Directive (1999/5/EC) and we declare compliance with the following standards :

Safety : EN60950:2000
EMC : EN55022:1998 Class B + A1:2000
EN55024:1998
EN61000-3-2:1995 + A14:2000
EN61000-3-3:1995

Year in which CE marking was First affixed : 2003

Issued by : Brother Industries, Ltd.

Date : 21 May, 2003

Place : Nagoya, Japan

Signature :

Takashi Maeda





Takashi Maeda
Manager
Quality Management Group
Quality Management Dept.
Information & Document Company

Safety precautions

To use the fax machine safely

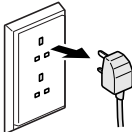
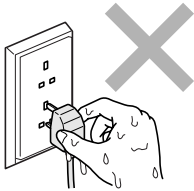
Save these instructions for later reference.

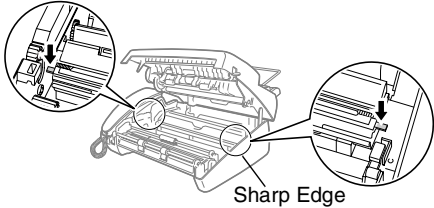
WARNING

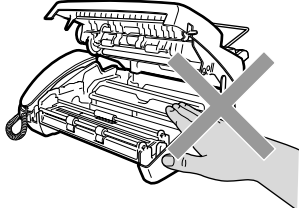
	<p>There are high voltage electrodes inside the fax machine. Before you clean the fax machine or clear a paper jam, make sure you have unplugged the power cord from the power outlet.</p> 	<p>Do not handle the plug with wet hands. Doing this might cause an electrical shock.</p> 
	<p>Be careful not to cut yourself on the sharp edges of the metal part shown in the illustration.</p> 	
	<p>After you have just used the machine, some internal parts are extremely HOT! Please be careful.</p> 	

WARNING

- Use caution when installing or modifying telephone lines. Never touch telephone wires or terminals that are not insulated unless the telephone line has been disconnected at the wall socket. Never install telephone wiring during a lightning storm. Never install a telephone wall socket in a wet location.
- Install equipment with a power cord near a socket-outlet that is easily accessible.
- Do not use a telephone in the vicinity of a gas leak to report a leak.

Caution

- Lightning and power surges can damage this product! We recommend that you use a quality surge protection device on the AC power line and on the telephone line, or unplug the lines during a lightning storm.
- Do not use this product near appliances that use water, in a wet basement or near a swimming pool.
- Avoid using a telephone other than a cordless type during an electrical storm. There may be a remote risk of electric shock from lightning.

Choosing a location

Place the fax machine on a flat, stable surface that is free of vibration and shocks, such as a desk. Put the fax machine near a telephone socket and a standard, grounded power outlet. Choose a location where the temperature remains between 10°C and 35°C.

! Caution

- Avoid placing the fax machine in a high-traffic area.
- Do not place near heaters, air conditioners, water, chemicals, or refrigerators.
- Do not expose the fax machine to direct sunlight, excessive heat, moisture, or dust.
- Do not connect the fax machine to electrical outlets controlled by wall switches or automatic timers.
- Disruption of power can wipe out information in the fax machine's memory.
- Do not connect the fax machine to electrical outlets on the same circuit as large appliances or other Equipment that might disrupt the power supply.
- Avoid interference sources, such as speakers or the base units of cordless phones.



Quick Reference Guide

Sending faxes

Automatic transmission

- 1 Insert the document face down in the ADF (up to 10 pages).
- 2 Enter the fax number you want to call.
- 3 Press **Start/Copy**.

Receiving Faxes

For a detailed explanation about receiving faxes please see Chapter 5 of the User's Guide.

Manual Reception

- 1 Pick up the handset.
- 2 Press **Start/Copy** if you hear fax tones (beeps).





If you set Fax Detect to ON, you don't have to press **Start/Copy**. Just wait until the machine takes over the call automatically. (See *Fax Detect* on page 5-5.)

- 3 When the LCD shows **RECEIVE**, replace the handset.



Storing numbers

Storing Tel-Index Numbers for Index

- 1 Press **Menu/Set**, **6**, **1**.
- 2 Enter a number (up to 20 digits), and then press **Menu/Set**.
- 3 Enter a name (up to 15 characters) or leave it blank, and then press **Menu/Set**.
- 4 Press  or  to select the type of number and press **Menu/Set**.
- 5 Press **Stop**.

Dialling operations

Searching the Index



- 1 Insert the document face down in the ADF.
- 2 Press **Search/Mute** and use the dial pad to enter the first letter of the name you are looking for.
- 3 Press  or  to search the memory.
- 4 Press **Start/Copy**, when the LCD shows the name you want to call.

Making copies

Making a single copy

- 1 Insert the document face down in the ADF.
- 2 Press **Start/Copy** twice.

Sorting multiple copies





- 1 Insert the document face down in the ADF.
- 2 Press **Start/Copy**.
- 3 Enter the number of copies you want (up to 99).
- 4 Press **Menu/Set**.
- 5 Press  or  to select **SORT**, and then press **Start/Copy**.

Message Manager

Turning ON Message Manager Mode

- 1 Record the Outgoing Message (TAD MESSAGE).
- 2 Press  until it lights.

Recording OGM

- 1 Press **Menu/Set**, **8**, **3**.
- 2 Press  or  to select **TAD MESSAGE**, and then press **Menu/Set**.
- 3 Press  or  to reach **RECORD MSG**, and then press **Menu/Set**.
- 4 Pick up the handset to record a message.
- 5 Replace the handset.

Playing a Voice Message

- 1 Press **Play/Record**.
- 2 Use * (RWD) to repeat a message.
Use # (FWD) to skip a message.
- 3 Press **Stop**.

Printing a Fax Message

- 1 Press **Play/Record**.
- 2 After voice messages have played, press **1**.

Erasing Messages

To erase voice messages individually

- 1 Press **Play/Record**.
- 2 Press **Erase** after the two short beeps or while the message is playing.
- 3 Press **1**.
- 4 Press **Stop**.

To erase messages all at once



- 1 Press **Erase**.
- 2 Press  or  to select **ERASE ALL VOICE?**, **ERASE ALL DOC?** or **ERASE ALL MSG?**, and then press **Menu/Set**.
- 3 Press **1**.

Table of Contents

1

Introduction	1-1
Using this Guide	1-1
Finding information	1-1
Symbols used in this Guide	1-1
Part names and functions	1-2
FAX-T98 control panel overview	1-4
About fax machines	1-7
Fax tones and handshake	1-7
ECM (Error Correction Mode)	1-8
Connections	1-9
Connecting an external telephone	1-9
Connecting an external telephone answering device (TAD)	1-10
Sequence	1-10
Connections	1-11
Recording outgoing message (OGM) on an external TAD	1-12
Using extension telephones (For U.K. only)	1-13
Multi-Line Connections (PABX)	1-15
If you are Installing the Fax machine to Work with a PABX	1-15
Custom features on your phone line	1-15

2

Paper	2-1
About paper	2-1
Handling and using special paper	2-1
Paper specifications for the paper tray	2-1
How to load paper	2-2
To load paper	2-2

3

On-Screen Programming	3-1
User-friendly programming	3-1
Menu table	3-1
Memory Storage	3-1
Navigation keys	3-2

Initial Setup	4-1
Getting started	4-1
Setting Tone or Pulse dialling mode	4-1
Setting the Date and Time	4-1
Setting the Station ID.....	4-2
Entering text	4-3
Inserting spaces	4-3
Making corrections	4-4
Repeating letters	4-4
Special characters and symbols	4-4
Setting the Beeper Volume.....	4-5
Setting the Speaker Volume	4-5
Setting the Ring Volume	4-5
PABX and TRANSFER.....	4-6
Setting PABX.....	4-6
Setting the Clock Change	4-7
Melody Settings	4-8
Setting the Ring Pattern.....	4-8
Setting the Music on Hold.....	4-8

Setup Receive	5-1
Basic receiving operations.....	5-1
Choosing the Receive Mode.....	5-1
To select or change your Receive Mode	5-2
Setting the Ring Delay	5-3
Setting the F/T Ring Time (FAX/TEL mode only)	5-3
Recording the Fax/Tel Outgoing Announcement (F/T MESSAGE)	5-4
Fax Detect	5-5
Printing a reduced incoming fax	5-6
Reception into memory.....	5-7
Receiving a fax at the end of a conversation.....	5-7
Advanced receiving operations.....	5-8
Operation from extension telephones.....	5-8
For FAX/TEL mode only	5-8
Remote Call Transfer.....	5-9
To transfer a telephone call to the fax machine.....	5-9
Changing Remote Codes	5-10
To change Remote Codes.....	5-10
Polling.....	5-11
Secure Polling	5-11
Setting up Polling Receive.....	5-11
Setup for Polling Receive with Secure Code	5-12
Setup Delayed Polling Receive	5-12

Sequential Polling.....	5-13
Telephone Services.....	5-14
Caller ID (Caller IDentification) (U.K. Only)	5-14
Advantages of Caller ID.....	5-14
For Business	5-14
At Home	5-14
Set the Caller ID to ON.....	5-15
How Does the Caller ID Work?.....	5-15
The Caller ID Appears on the Display	
When Your Telephone Rings	5-15
The Caller ID is Stored in Your Machine's	
Memory	5-16
Selecting a Caller ID from the Memory	
for Call Reply.....	5-17
To Activate Certain Network Services	
When Using Call Reply	5-18
Call Reply to DDI numbers via Caller ID	5-19
Clearing the Caller ID Stored in Memory.....	5-19
Printing Caller ID List.....	5-19
BT Call Sign (For U.K. Only)	5-20
To enable the machine to work with BT Call Sign	
(Only with your external phone)	5-20

6

Setup Send	6-1
How to dial.....	6-1
Manual dialling.....	6-1
Search	6-1
How to fax.....	6-2
Automatic transmission	6-2
Manual transmission.....	6-3
Sending a fax at the end of a conversation	6-4
Basic sending operations	6-5
Sending faxes using multiple settings	6-5
Contrast.....	6-5
Fax resolution	6-6
Multiple Resolution Transmission.....	6-6
Manual and automatic fax redial.....	6-7
Cancelling a job while scanning,	
dialling and sending the document.....	6-7
Cancelling a scheduled job.....	6-8
Advanced sending operations	6-9
Electronic Cover Page.....	6-9
Cover Page for Next Fax Only	6-10
Always send Cover Page	6-11

Using a printed Cover Page	6-11
Composing your own comments	6-12
Overseas Mode	6-13
Call Reservation	6-14
Print Sample Call Back Message	6-15
Delayed Fax.....	6-15
Setting up Polled Transmission (Standard)	6-16
Setup for Polling Transmit with Secure Code	6-17
Memory Transmission	6-18
Out of memory message	6-19
Broadcasting.....	6-19
Interrupting Delayed Fax and Polled Transmit jobs ...	6-20

7

Setup Index for Easy Dialling	7-1
Storing Tel-Index Numbers for Index.....	7-1
Changing Tel Index Numbers for Index.....	7-2
Storing Groups.....	7-3
Changing the Numbers for Groups.....	7-4
When you change a Group name.....	7-4
When you erase the numbers	7-4
When you add the numbers to a Group	7-4
Dialling options	7-5
Manual dialling.....	7-5
On Hook Dialling.....	7-5
Search	7-6
Answering Calls with the Speakerphone	7-6
Mute.....	7-6
Pause	7-7
Redial (Tel)	7-7
Redial (Fax)	7-7
Tone or Pulse	7-8

8

Message Manager	8-1
Message Manager Mode.....	8-1
Setting Up Message Manager	8-1
Flexible Memory Settings (Message Store).....	8-2
Setting the Message Store	8-3
Recording the Message Manager's Outgoing Message (TAD MESSAGE)	8-4
Listening to the Outgoing Message (OGM)	8-5
Erasing the Outgoing Message (OGM)	8-5
Activating Message Manager Mode	8-6
Message Indicator	8-6
What Happens When the Memory Is Full.....	8-7

Playing Voice Messages	8-7
Printing a Fax Message	8-8
Backup Printing Option	8-8
Erasing Messages	8-9
To erase voice messages individually	8-9
To erase messages all at once	8-9
Setting the Maximum Time for Incoming Messages ...	8-10
Setting the Toll Saver	8-10
ICM Recording Monitor	8-11
Recording a Conversation	8-11
Fax Forwarding/Paging	8-12
Programming a Fax Forwarding Number	8-12
Recording the Paging Outgoing Message (OGM)	8-13
Programming the Paging Number	8-13
Remote Retrieval	8-14
Using the Remote Access Code	8-14
Changing the Remote Access Code	8-15
Remote Control Commands	8-16
Retrieving the Memory Status List	8-18
Retrieving Fax Messages	8-19
Changing the Fax Forwarding Number	8-20

9

Printing reports	9-1
Printing reports	9-1
Setting Reports	9-1
To Print a Report	9-1
Customizing the Transmission Verification (Xmit) Report	9-2
Setting the Journal Period	9-3

10

Making copies	10-1
Using the fax machine as a copier	10-1
Copy operations	10-1
Making a single copy	10-2
Copy options: Single or Multiple copies, Sort/Stack, Reduce/Enlarge	10-2

11

Important information	11-1
Important Safety Instructions	11-1
Trademarks	11-4

Troubleshooting and routine maintenance	12-1
Troubleshooting	12-1
Error messages	12-1
Printer Jam or Paper Jam	12-3
Document Jam	12-3
Paper Jam	12-4
If you are having difficulty with the fax machine	12-6
How to improve print quality	12-8
Cleaning the print head	12-8
Routine maintenance	12-10
Cleaning the scanner	12-10
Changing the ribbon	12-11
Packing and shipping the Fax machine	12-15

G

Glossary	G-1
-----------------------	------------

S

Specifications	S-1
General	S-1
Copy	S-1
Fax	S-2

Index	I-1
--------------------	------------

Accessory List	A-1
-----------------------------	------------

1 Introduction

Using this Guide

Thank you for buying a Brother fax machine. This fax machine is simple to use, with LCD screen instructions to guide you through programming it. You can make the most of the fax machine by taking a few minutes to read this Guide.

Finding information

All the chapter headings and subheadings are listed in the Table of Contents. You will be able to find information about a specific feature or operation by checking the Index at the back of this Guide.

Symbols used in this Guide

Throughout this Guide you'll see special symbols alerting you to important warnings, notes and actions. To make things clearer and to help you press the correct keys, we used special fonts and added some of the messages that will appear in the LCD.

Bold Bold typeface identifies specific keys on the fax machine control panel.

Italics Italicized typeface emphasizes an important point or refers you to a related topic.

`Courier New` Courier New typeface identifies the messages on the LCD of the Fax machine.

 Warnings inform you what to do to avoid possible personal injury or damage to the machine.

 Cautions specify procedures you must follow or avoid to prevent possible damage to the machine.

 Notes tell you how you should respond to a situation that may arise or give tips about how the current operation works with other features.

 Improper Setup alerts you to devices and operations that are not compatible with the fax machine.

Part names and functions

■ Front view

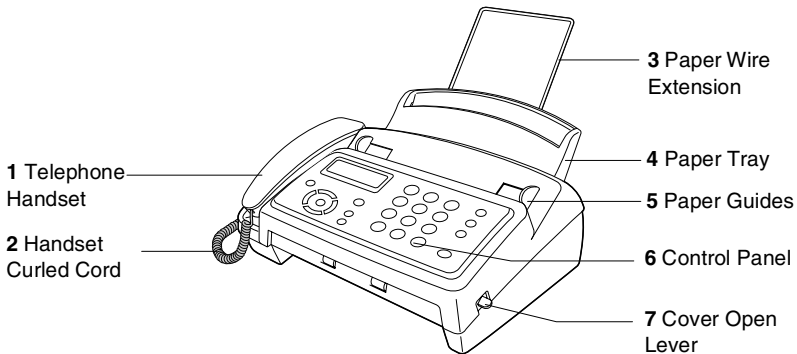

No.	Name	Description
1	Telephone Handset	Use this to speak/listen to telephone callers.
2	Handset Curled Cord	To connect the machine and the telephone handset.
3	Paper Wire Extension	Supports the recording paper.
4	Paper Tray	Load paper here.
5	Paper Guides	Press and slide it to fit the document width.
6	Control Panel	Use the keys and display to control the fax machine.
7	Cover Open Lever	To open top cover, lift this.

■ Rear view

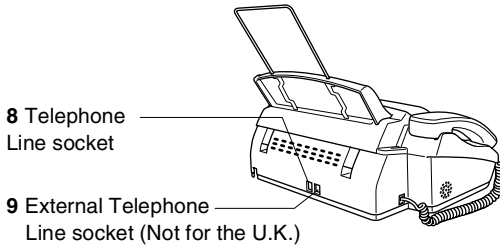

No.	Name	Description
8	Telephone Line socket	Plug in the modular plug on the telephone line here.
9	External Telephone Line socket	Plug in the modular plug on the external telephone line here. (Not for the U.K.)

FAX-T98 control panel overview

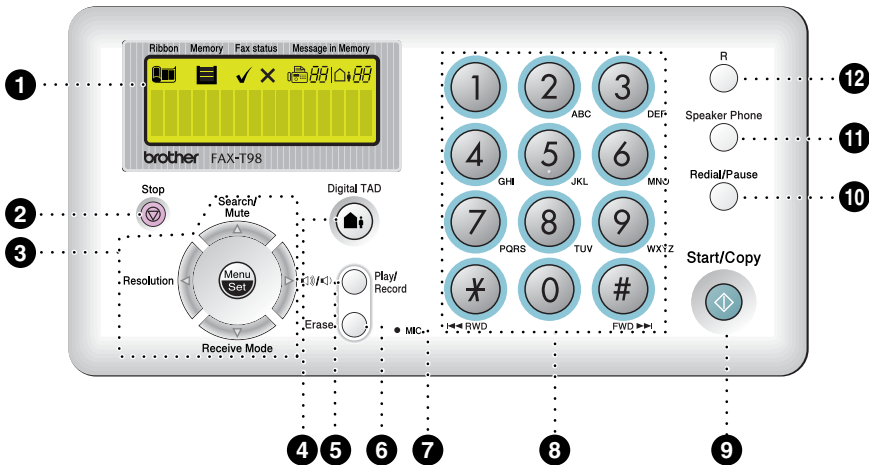

1 LCD (Liquid Crystal Display)

Displays messages to help you set up and operate your machine.

2 Stop

Stops a fax, cancels an operation or exits from Menu mode.

3 Navigation keys:

Menu/Set

Lets you access the menu and programming mode and store your settings in your machine.



Resolution

Sets the resolution when you send a fax or make a copy.



Search/Mute

Lets you look up numbers stored in Tel-Index.



Volume

Adjust the ring or speaker volume.



Receive Mode

Use to select how your machine will handle incoming calls.

4 Digital TAD

Lets you activate Message Manager. Also, notifies you that you have voice or fax messages in the memory.

5 Play/Record

Lets you listen to voice messages and print fax messages stored in memory. This also lets you record telephone calls.

6 Erase

Lets you delete voice messages, fax messages or all messages.

7 MIC (Microphone)

Picks up your voice when you speak to another party using Speaker Phone.

8 Dial Pad

Dials phone and fax numbers and can be used as a keyboard for entering information into your machine.

key lets you switch the dialling type during a telephone call from "PULSE" to "TONE".

9 Start/Copy

Starts an operation, such as sending a fax.

With a document in the ADF: Makes a copy.

10 Redial/Pause

Re-dials the last number called.

Also inserts a pause in autodial numbers.

11 Speaker Phone

Lets you speak to the person at the other end and dial telephone and fax numbers without lifting the handset.

12 R

Use this key to gain access to an outside line and/or to recall the operator or transfer a call to another extension when it is connected to a PABX.

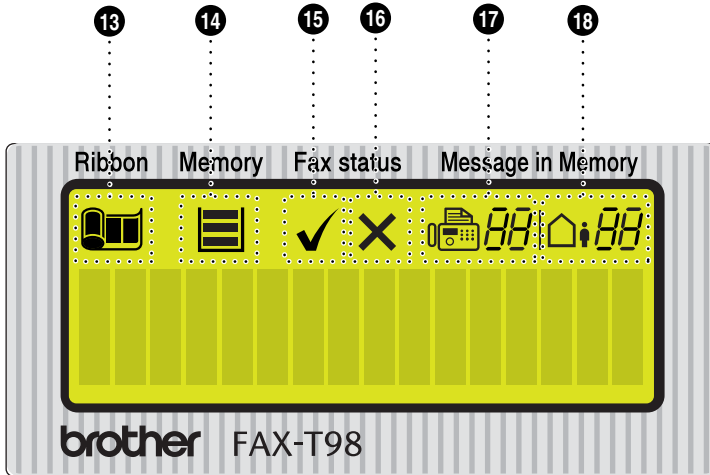

LCD Indicators

13  **Ribbon**

Informs you of the status of remaining ribbon. See *Changing the ribbon* on page 12-11.

14  **Memory**

Informs you of the memory status.

: Remaining memory will be 100%-50%.

: Remaining memory will be 49%-25%.

: Remaining memory will be 24%-5%.

: Remaining memory will be 4%-0%.

If  flashes and the screen displays **OUT OF MEMORY**, you cannot start an activation which requires memory. Erase the incoming voice messages or fax messages stored in the memory in order to make additional memory available. See *Erasing Messages* on page 8-9.

15  **Fax Status**

Informs you that the fax transmission or reception was successful. This sign will disappear when you press any key.

16  **Fax Status**

Informs you that the fax transmission or reception was unsuccessful. This sign will disappear when you press any key.

17  **(Message in Memory)**

Informs you that the total number of fax messages (up to 99 messages) stored in the memory storage.

18  **(Message in Memory)**

Informs you that the total number of voice messages (up to 99 messages) stored in Digital TAD.

About fax machines

Fax tones and handshake

When someone is sending a fax, the fax machine sends fax calling tones (CNG tones). These are quiet, intermittent beeps every 4-seconds. You'll hear them after you dial and press **Start/Copy** and they will continue for about 60 seconds after dialling. During that time, the sending machine must begin the "handshake" with the receiving machine.

Each time you use automatic procedures to send a fax, you are sending CNG tones over the phone line. You'll soon learn to listen for these quiet beeps each time you answer a phone on your fax line, so you will know if you are receiving a fax message.

The receiving fax responds with fax receiving tones, which are loud, chirping sounds. A receiving fax chirps for about 40 seconds over the phone line, and the LCD shows `RECEIVE`.

If the fax machine is set to the `FAX ONLY` mode, it will answer every call automatically with fax receiving tones. If the other person hangs up, the fax machine will continue to send the "chirps" for about 40 seconds, and the LCD continues to show `RECEIVE`. To cancel the receiving, press **Stop**.

The fax 'handshake' is the time in which the sending machine's CNG tones and the receiving machines "chirps" overlap. This must be for at least 2 to 4 seconds, so the fax machines can understand how each is sending and receiving the fax. The handshake cannot begin until the call is answered, and the CNG tones only last for about 60 seconds after the number is dialed. So it is important for the receiving machine to answer the call in as few rings as possible.



When you have an external Telephone Answering Device (TAD) on your fax line, your TAD will decide the number of rings before the call is answered.

Pay special attention to the directions for connecting a TAD in this chapter. (See *Connecting an external telephone answering device (TAD)* on page 1-10.)

ECM (Error Correction Mode)

The Error Correction Mode (ECM) is a way for the fax machine to check a fax transmission while it is in progress. ECM transmissions are only possible between machines that both have this feature. If they do, you may send and receive fax messages that are continuously being checked by the machine.

The fax machine must have enough memory for this feature to work.

Connections

Connecting an external telephone

Your machine is equipped with a handset that you can use as a regular phone. However you can also connect a separate telephone to your machine, as shown below.

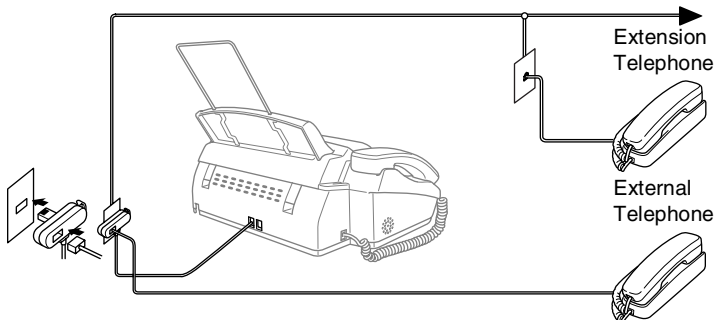

Whenever this external phone (or TAD) is in use, the screen displays **EXT. TEL IN USE**, and, if the fax handset is lifted, an alarm sounds. To disconnect the call on the external phone and switch to the fax, lift the handset and press **Speaker Phone**.

Connecting an external telephone answering device (TAD)

Sequence

You may choose to connect an answering device. However, when you have an **external** TAD on the same telephone line as the machine, the TAD answers all calls and the machine “listens” for fax calling (CNG) tones. If it hears them, the machine takes over the call and receives the fax. If it doesn’t hear CNG tones, the machine lets the TAD continue playing your outgoing message so your caller can leave you a voice message.

The TAD must answer within four rings (the recommended setting is two rings). The machine cannot hear CNG tones until the TAD has answered the call, and with four rings there are only 8 to 10 seconds of CNG tones left for the fax “handshake”. Make sure you carefully follow the instructions in this guide for recording your outgoing message. We do not recommend using the toll saver feature on your external answering machine if it exceeds five rings.



If you do not receive all your faxes, reduce the Ring Delay setting on your external TAD.

- ⊘ **Do not connect a TAD elsewhere on the same phone line**
(unless you have the Distinctive Ring service).

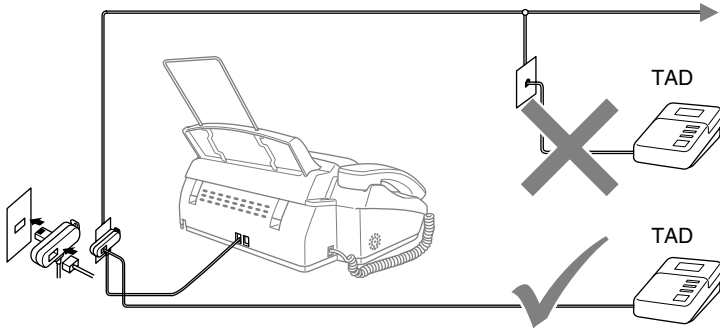

Connections

The external TAD must be connected as shown above.

- 1** Set your external TAD to one or two rings. (The machine's Ring Delay setting does not apply.)
- 2** Record the outgoing message on your external TAD.
- 3** Set the TAD to answer calls.
- 4** Set the Receive Mode to TAD :MSG MGR.
(See *Choosing the Receive Mode* on page 5-1.)

Recording outgoing message (OGM) on an external TAD

Timing is important in recording this message. The message sets up the ways to handle both manual and automatic fax reception.

- 1** Record 5 seconds of silence at the beginning of your message. (This allows the fax machine time to listen for the fax CNG tones of automatic transmissions before they stop.)
- 2** Limit your message to 20 seconds.
- 3** End your 20-second message by giving your Fax Receive Code for people sending manual faxes. For example:
*“After the beep, leave a message or send a fax by pressing * 51 and Start.”*



We recommend beginning your OGM with an initial 5-second silence because the fax machine cannot hear fax tones over a resonant or loud voice. You may try omitting this pause, but if the fax machine has trouble receiving, then you must re-record the OGM to include it.

Using extension telephones (For U.K. only)

It may be that your premises are already wired with parallel extension telephones, or you intend to add extension telephones to your line, in addition to your machine. While the simplest arrangement is straightforward parallel connection, there are some reasons as to why this arrangement will cause unsatisfactory service, the most obvious of which is inadvertent interruption of a facsimile transmission by someone picking up an extension telephone in order to make an outgoing call. Additionally, fax receive may not operate reliably in such a simple configuration.

This machine may also be set to make a delayed transmission (i.e. a transmission at a pre-set time). This pre-set job may coincide with someone picking up an extension handset.

Such problems can easily be eliminated however, if you arrange modification of your extension wiring circuit, such that extension devices are connected “downstream” of your machine, in a master/slave configuration. In such a configuration, this machine can always detect whether a telephone is in use, thus it will not attempt to seize the line during that time. This is known as “telephone off-hook detection.”

The inadvisable configuration is shown in figure 1 below, and the recommended master/slave configuration is shown in figure 2.

This new connection configuration can be arranged by contacting BT, Kingston upon Hull Telecommunications, your PABX maintainer or a qualified telephone installation company as appropriate. Simply explained, the extension telephone circuit should be terminated on a normal modular plug (BT 431A style), which in turn should be inserted into the modular socket of the white “T”-shaped connector provided as part of the line cord assembly.

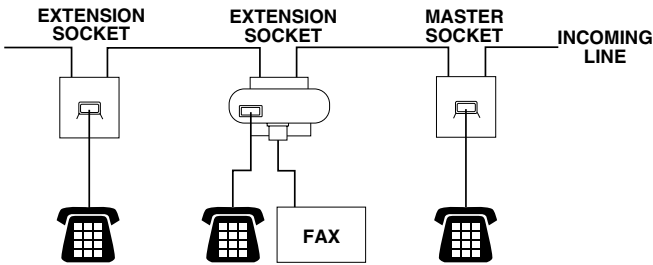

INADVISABLE CONNECTION OF EXTENSION SOCKETS
Fig. 1.

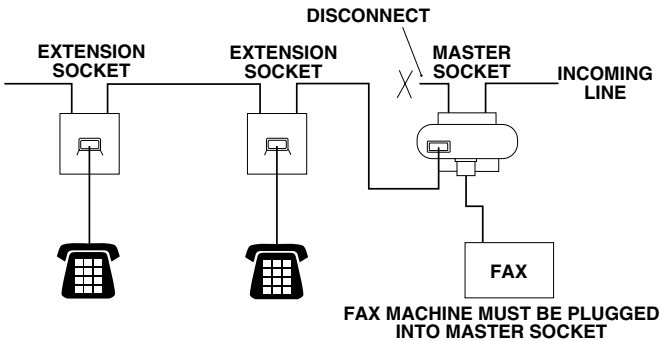

RECOMMENDED CONNECTION OF EXTENSION SOCKETS
Fig. 2.

Multi-Line Connections (PABX)

Most offices use a central telephone system. While it is often relatively simple to connect the machine to a key system or a PABX (Private Automatic Branch Exchange), we suggest that you contact the company that installed your telephone system and ask them to connect the Fax machine for you. It is advisable to have a separate line for the Fax machine. You can then leave the Fax machine in FAX ONLY mode to receive faxes any time of day or night.

If the Fax machine is to be connected to a multi-line system, ask your installer to connect the unit to the last line on the system. This prevents the unit from being activated each time a telephone call is received.

- ⊘ As with all fax units, this machine must be connected to a two wire system. If your line has more than two wires, proper connection of the Fax machine cannot be made.

If you are Installing the Fax machine to Work with a PABX

- 1 It is not guaranteed that the unit will operate correctly under all circumstances with a PABX. Any cases of difficulty should be reported first to the company that handles your PABX.
- 2 If all incoming calls will be answered by a switchboard operator, it is recommended that the Receive Mode be set to **MANUAL**. All incoming calls should initially be regarded as telephone calls.

Custom features on your phone line

If you have Voice Mail, Call Waiting, RingMaster, an answering service, an alarm system or other custom feature on one phone line it may create a problem with the operation of your fax machine. (See *Custom features on a single line.* on page 12-7.)

2 Paper

About paper

Handling and using special paper

- Store paper in its original packaging, and keep it sealed. Keep the paper flat and away from moisture, direct sunlight and heat.

Paper specifications for the paper tray

Size:	A4
Weight:	64 to 90 g/m ²
Thickness:	0.08 to 0.10 mm
Capacity:	up to 30 sheets



The fax machine can only scan an image 208 mm wide, regardless of how wide the paper is.



Do not use paper:

- that is extremely shiny or highly textured
- that is previously printed by a printer
- that cannot be arranged uniformly when stacked
- that is made with a short grain

How to load paper

To load paper

- 1 Fan the stack of paper well to avoid paper jams and mis-feeds.

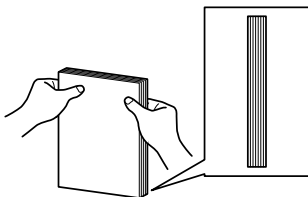

Tap the stack of paper so the edges are even.

- 2 Gently insert the paper.
The side to be printed on must be face down.

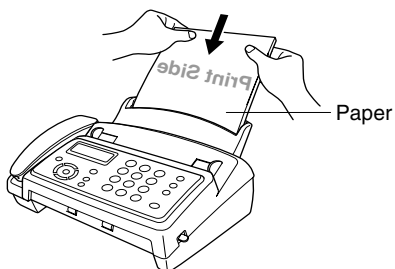

3 On-Screen Programming

User-friendly programming

The fax machine is designed to be easy to use with LCD on-screen programming using the navigation key. User-friendly programming helps you take full advantage of all the menu selections the fax machine has to offer.

Since your programming is done on the LCD, we have created step-by-step on-screen instructions to help you program the fax machine. All you need to do is follow the instructions as they guide you through the menu selections and programming options.

Menu table

You can probably program the fax machine without the User's Guide. But to help you understand the menu selections and options that are found in the fax machine programs, use the Menu table on page 3-4.



You can program the fax machine by pressing **Menu/Set** followed by the menu numbers.

For example to set **RESOLUTION** to **FINE**:

Press **Menu/Set, 3, 4** and  or  to select **FINE**.

Press **Menu/Set**.

Memory Storage

If there is a power failure, you will not lose your menu settings because they are stored permanently. Temporary settings (such as Contrast, Overseas Mode, and so on) will be lost. You may also have to reset the date and time.

Navigation keys

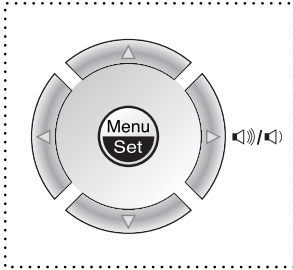

- * Access the menu
- * Go to the next menu level
- * Accept an option



- * Scroll through the current menu level

Stop



- * Exit the menu

You can access the menu mode by pressing **Menu/Set**.

When you enter the menu, the LCD scrolls.

ENTER NO. & SET

Press **1** for Initial Setup menu

—OR—

1. INITIAL SETUP

Press **2** for Setup Receive menu

—OR—

2. SETUP RECEIVE

Press **3** for Setup Send menu

—OR—

3. SETUP SEND

Press **4** for Cancel Job menu

—OR—

4. CANCEL JOB

Press **5** for Interrupt menu

—OR—

5. INTERRUPT

Press **6** for Set Index menu

—OR—

6. SET INDEX

Press **7** for Print Reports menu

—OR—

7. PRINT REPORTS

Press **8** for Setup TAD menu

—OR—

8. SETUP TAD



Press **9** for Setup Melody menu



—OR—

9. SETUP MELODY

Press **0** for Miscellaneous menu

0. MISCELLANEOUS

You can scroll more quickly through each menu level by pressing the arrow keys  or . You can then select an option by pressing **Menu/Set** when that option appears on the LCD. Then the LCD shows the next menu level.

Press  or  to scroll to your next menu selection.

Press **Menu/Set**.

When you finish setting an option, the LCD shows `ACCEPTED`.



Use  to scroll backward if you passed your choices or want to save keystrokes.

To access the menu, press **Menu/Set**.

Press the Menu numbers.
(ex. Press **1, 1** for Tone/Pulse)

—OR—



Main Menu	Menu Selections	Options	Descriptions	Page
1. INITIAL SETUP	1. TONE/PULSE	TONE PULSE	Selects the dialling mode.	4-1
	2. DATE/TIME	—	Enter date and time for LCD display and to print on transmissions.	4-1
	3. STATION ID	—	Program the name, fax number and telephone number to appear on each transmitted page.	4-2
	4. BEEPER	OFF LOW HIGH	Adjust the volume level of the beeps when you press a key, an error occurs or a document is sent or received.	4-5
	5. PBX	ON OFF	Turn on this function if the machine is connected to PABX (Private Automatic Branch Exchange.)	4-6
	6. CLOCK CHANGE	SUMMER WINTER	Adjusts the fax machine's clock by one hour for summer/winter time.	4-7
2. SETUP RECEIVE	1. RING DELAY	RING DELAY TOLL SAVER	Sets the number of rings before your machine answers in FAX/TEL, FAX ONLY or TAD (Message Manager) mode. You can set Toll Saver feature.	5-3
	2. F/T RING TIME	70 40 30 20	Sets the time for "FAX/TEL pseudo-ring" in FAX/TEL (F/T) Mode.	5-3
	3. FAX DETECT	ON SEMI OFF	Receive fax messages without pressing the Start/Copy key.	5-5



The factory setting (option) is shown in bold.

To access the menu, press  **Menu/Set**.

Press the Menu numbers.
(ex. Press 1, 1 for Tone/Pulse)

—OR—



Main Menu	Menu Selections	Options	Descriptions	Page
2. SETUP RECEIVE (Continued)	4. REMOTE CODE	ON (✳51, #51, ✳81) OFF	Enter code to activate or deactivate machine from a remote location or to transfer voice call from cordless phone to your machine.	5-10
	5. REDUCTION	AUTO 100% 93% 87% 75%	Reduces size of image.	5-6
	6. MEM. RECEIVE	ON OFF	Automatically stores any incoming faxes in its memory if it runs out of paper.	5-7
	7. POLLING RX	STANDARD SECURE TIMER	Sets up your machine to poll another fax machine.	5-11
3. SETUP SEND	1. COVERPG SETUP	NEXT FAX ONLY ON OFF PRINT SAMPLE	Automatically sends a programmable cover page or prints a sample coverpage.	6-9
	2. COVERPAGE NOTE	—	Program a customized message for fax cover page.	6-9
	3. CONTRAST	AUTO LIGHT DARK	Change the lightness or darkness of a fax you are sending.	6-5
	4. RESOLUTION	STANDARD FINE S. FINE PHOTO	Allows you to change resolutions page by page.	6-6
	5. OVERSEAS MODE	ON OFF	Special setting for international transmissions.	6-13
	6. CALL RESERVE	ON OFF PRINT SAMPLE	You can send a fax, then speak or print a sample call back message.	6-14



The factory setting (option) is shown in bold.

To access the menu, press  **Menu/Set**.

Press the Menu numbers.
(ex. Press **1**, **1** for Tone/Pulse)

—OR—



Main Menu	Menu Selections	Options	Descriptions	Page
3. SETUP SEND (Continued)	7. DELAYED FAX	—	Set your machine to send your documents later.	6-15
	8. POLLED TX	STANDARD SECURE	Set up your machine with a document to be retrieved by another fax machine.	6-16
	9. MEMORY TX	NEXT FAX ONLY ON OFF	You can send faxes from memory.	6-18
4. CANCEL JOB	—	—	Cancel a delayed fax or polling job.	6-7
5. INTERRUPT	—	—	Send a fax now, even if you have your machine set to send a fax later, or if you have it set for Polling.	6-20
6. SET INDEX	1. SET TEL. INDEX	—	You can store names/numbers for up to 100 locations.	7-1
	2. CHANGE INDEX	—	Change names/numbers of Tel Index.	7-2
	3. SETUP GROUPS	—	Set up a Group number for broadcasting.	7-3
	4. CHANGE GROUP	—	Change a Group number.	7-4
7. PRINT REPORTS	1. HELP LIST	—	Print lists and reports of activity.	9-1
	2. XMIT REPORT	ON OFF		9-2
	3. FAX JOURNAL	PRINT JOURNAL JOURNAL PERIOD		9-3
	4. TEL. INDEX	—		9-1
	5. USER SETTINGS	—		9-1
	6. MEMORY STATUS	—		9-1



The factory setting (option) is shown in bold.

To access the menu, press  **Menu/Set**.

Press the Menu numbers.
(ex. Press 1, 1 for Tone/Pulse)

—OR—



to select



to select



to accept



Stop

to exit

Main Menu	Menu Selections	Options	Descriptions	Page
8. SETUP TAD	1. MESSAGE STORE	DOC: ON DOC: OFF VOICE: ON VOICE: EXT VOICE: OFF	Select if memory will store fax, voice or both.	8-3
	2. BACKUP PRINT	ON OFF	Automatically prints a copy of faxes received into memory.	8-8
	3. OGM	TAD MESSAGE F/T MESSAGE PAGING MSG.	Select/Record outgoing message.	8-4
	4. ICM MAX. TIME	35-60 seconds (20-60 seconds for Ireland)	Select maximum length of incoming messages.	8-10
	5. ICM REC. MONITR	ON OFF	Select ON or OFF for voice messages as they come in.	8-11
	6. FAX FWD/PAGING	OFF FAX FORWARD PAGING	Set fax machine to forward fax/message—OR—to call your pager.	8-12
	7. REMOTE ACCESS	---*	Set code for retrieving messages.	8-15



The factory setting (option) is shown in bold.

To access the menu, press  **Menu/Set**.

Press the Menu numbers.
(ex. Press **1, 1** for Tone/Pulse)

—OR—

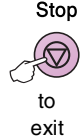

Main Menu	Menu Selections	Options	Descriptions	Page
9. SETUP MELODY	1. RING PATTERN	SIGNAL MELODY1 MELODY2 MELODY3 MELODY4	Selects ring pattern.	4-8
	2. MUSIC ON HOLD	OFF MELODY1 MELODY2 MELODY3 MELODY4	Selects the music type or sets to off the music on hold.	4-8
0. MISCELLANEOUS	1. CALLER ID (U.K. Only)	ON OFF DISPLAY ID PRINT REPORT	View and dial back, or print a list of the last 30 Caller IDs stored in memory.	5-15
	2. BT CALL SIGN (U.K. Only)	ON OFF	Use with BT Call Sign.	5-20





The factory setting (option) is shown in bold.

4 Initial Setup

Getting started

Setting Tone or Pulse dialling mode

Your machine comes set for Tone dialling service (multi-frequency). If you have Pulse dialling service (rotary), you need to change the dialling mode.

- 1 Press **Menu/Set, 1, 1.**
- 2 Press  or  to select PULSE (or TONE).
Press **Menu/Set.**
- 3 Press **Stop.**

1 . TONE / PULSE

Setting the Date and Time

The fax machine displays the date and time, and if you set up the Station ID it prints on every fax you send. If there is a power failure, you may have to reset the date and time. All other settings will not be affected.

- 1 Press **Menu/Set, 1, 2.**
- 2 Enter the last two digits of the year.
Press **Menu/Set.**
- 3 Enter two digits for the month.
Press **Menu/Set.**
(For example, enter 09 for September, or 10 for October.)
- 4 Enter two digits for the day.
Press **Menu/Set.**
(For example, enter 06.)
- 5 Enter the time in 24-Hour format.
Press **Menu/Set.**
(For example, enter 15:25 for 3:25 P.M.)
- 6 Press **Stop.**
The LCD now shows the date and time you set whenever the fax machine is in Standby mode.

2 . DATE / TIME

Setting the Station ID

You should store your name or company name and fax number to be printed on all fax pages that you send.

It is important that you enter the fax and telephone numbers in the internationally standardised format, i.e. in accordance with the following strict sequence:

- The “+” (plus) character (by pressing * key)
- Your Country Code (e.g. “44” for the United Kingdom, “41” for Switzerland)
- Your local area code minus any leading “0” (“9” in Spain)
- A space
- Your number on the local exchange, using spaces to aid readability as appropriate.

As an example, if the machine is installed in the United Kingdom and the same line is to be used for both fax and voice calls, and your national telephone number is 0161-444 5555, then you must set the fax and telephone number parts of your station ID as: +44 161444 5555.

1 Press **Menu/Set, 1, 3**.

2 Enter your fax number (up to 20 digits).

Press **Menu/Set**.



You cannot enter a hyphen.

3 Enter your telephone number (up to 20 digits).

Press **Menu/Set**.

(If your telephone number and fax number are the same, enter the same number again).



The telephone number will appear on cover pages you send.

3.STATION ID

4 Use the dial pad to enter your name (up to 20 characters).

Press **Menu/Set**.

(See *Entering text* below.)

5 Press **Stop**.

The LCD will show the date and time.



If the Station ID has already been programmed, the LCD will ask you to press **1** to make a change or **2** to exit without changing.

Entering text

When you are setting certain functions, such as the Station ID, you may need to type text into the fax machine. Most number keys have three or four letters printed below them. The keys for **0**, **#** and ***** do not have printed letters because they are used for special characters.

By pressing the appropriate number key repeatedly, you can access the character you want.

Press Key	one time	two times	three times	four times
2	A	B	C	2
3	D	E	F	3
4	G	H	I	4
5	J	K	L	5
6	M	N	O	6
7	P	Q	R	S
8	T	U	V	8
9	W	X	Y	Z

Inserting spaces

To enter a space, press  twice.



Making corrections

If you entered a letter incorrectly and want to change it, press  to move the cursor after the last correct letter. Then press **Stop**. All the letters above and to the right of the cursor will be deleted. Re-enter the correct characters. You can also back up and type over incorrect letters.

Repeating letters

If you need to enter a character that is on the same key as the previous character, press  to move the cursor to the right.

Special characters and symbols

Press *****, **#** or **0**, and then press  or  to move the cursor under the special character or symbol you want. Then press **Menu/Set** to select it.



Press *	for	(space) ! " # \$ % & ' () * + , - . / €
Press #	for	: ; < = > ? @ [] ^ _
Press 0	for	Ä Ë Ö Ü À Ç È É 0

Setting the Beeper Volume

You can change the beeper volume. The default (original) setting is **LOW**. When the beeper is on, the fax machine beeps every time you press a key or make a mistake and when a fax is being sent or received.

1 Press **Menu/Set, 1, 4.**
(**LOW, HIGH** or **OFF**)



4 . BEEPER

2 Press  or  to select your option.



3 When the LCD shows the option you want.
Press **Menu/Set.**

4 Press **Stop.**

Setting the Speaker Volume



You can adjust the speaker volume. Press **Speaker Phone** before you can adjust the volume. Press  then press  or  to adjust the volume level. The display shows the setting you are choosing. Each key press change the volume to the next setting. The new setting will remain until you change it again.

 You can adjust the speaker volume while you are listening to your OGM (Outgoing Message) and ICMs (incoming messages).

 If you turn Incoming Recording Monitor to **OFF (Menu/Set, 8, 5)**, the Speaker for screening calls will be disabled and you won't hear callers leaving messages. The volume for other operations can still be controlled using .

Setting the Ring Volume

You can adjust the ring volume when your machine is idle. You can select a ring volume level or press until the ring is off.



Press  then press  or  to adjust the volume level. With each key press, your machine rings so you can hear the current setting and the screen displays the setting you are choosing. Each key press changes the volume to the next setting. The new setting will remain until you change it again.

PABX and TRANSFER

The machine is initially set to be connected with PSTN (Public Switched Telephone Network) lines. However, many offices use a central telephone system or Private Automatic Branch Exchange (PABX). Your fax can be connected to most types of PABX. The recall facility on the machine supports timed break recall only (TBR), PABXs normally can work with this for gaining access to an outside line, or for transferring a call to another extension: The feature works when the **R** key is pressed.

Setting PABX

If your machine is connected to a PABX system, set PBX : ON. If not, set OFF.

- 1** Press **Menu/Set, 1, 5**.
- 2** Press  or  to select ON (or OFF).
- 3** Press **Menu/Set**.
- 4** Press **Stop**.

5 . PBX



You can program an **R** keypress as part of a number stored in a Tel-Index location. When programming the Tel-Index number (Function menu 6-1) press **R** first (the screen displays “!”), then enter the telephone number. If you do this, you do not need to press **R** each time before you dial using a Tel-Index location. (See *Storing Tel-Index Numbers for Index* on page 7-1.)



However, if PABX is set to OFF, you can't use the Tel-Index location that an **R** keypress is programmed into.

Setting the Clock Change

You can easily let the machine's clock gain or lose one hour by using this feature.

1 Press **Menu/Set, 1, 6.**

6 . CLOCK CHANGE

2 Press  or  to select TO SUMMER TIME ? or TO WINTER TIME ?.

3 Press **Menu/Set.**

4 Press **1** to change to Winter Time or Summer Time.

—**OR**—



Press **2** to exit without changing.

Melody Settings

Setting the Ring Pattern

You can select a ring pattern from signal (regular ring pattern) or 4 types of melody.

The default setting is SIGNAL.

- 1 Press **Menu/Set, 9, 1.**
- 2 Press  or  to select SIGNAL, MELODY1, MELODY2, MELODY3 or MELODY4 and press **Menu/Set.**
- 3 Press **Stop.**



1.RING PATTERN



Even if you select a melody for rings, F/T pseudo-ring cannot be changed to the melody.

Setting the Music on Hold

You can select the music on hold. You can also set the music to OFF.

- 1 Press **Menu/Set, 9, 2.**
- 2 Press  or  to select MELODY1, MELODY2, MELODY3, MELODY4 or OFF.
Press **Menu/Set.**
- 3 Press **Stop.**

5 Setup Receive

Basic receiving operations

Choosing the Receive Mode

There are four different Receive Modes for the fax machine. You can choose the mode that best suits your needs.

LCD	How it works	When to use it
FAX ONLY (automatic receive)	The fax machine automatically answers every call as a fax.	For dedicated fax lines.
FAX/TEL* (fax and telephone)	The fax machine controls the line and automatically answers every call. If the call is a fax it will receive the fax. If the call is not a fax it will ring (pseudo/double ring) for you to pick up the call.	Use this mode if you expect to receive lots of fax messages and few telephone calls. You cannot have an answering machine on the same line, even if it is on a separate wall socket on the same line. You cannot use the telephone company's Voice Mail in this mode.
MANUAL (manual receive)	You control the phone line and must answer every call yourself.	Use this mode when you are using a computer modem on the same line or if you don't receive many fax messages or with Distinctive Ring. If you hear fax tones, wait until the machine takes over the call, then hang up. (See <i>Fax Detect</i> on page 5-5.)
TAD:MSG MGR	The fax machine automatically answers every call. The messages are stored in order on a first come first served basis.	Use this mode to record voice or fax messages into the machine's memory. (See <i>Message Manager</i> on page 8-1.)

* In FAX/TEL mode you must set the Ring Delay and F/T Ring Time. If you have extension phones on the line, keep the Ring Delay set to 4 rings.

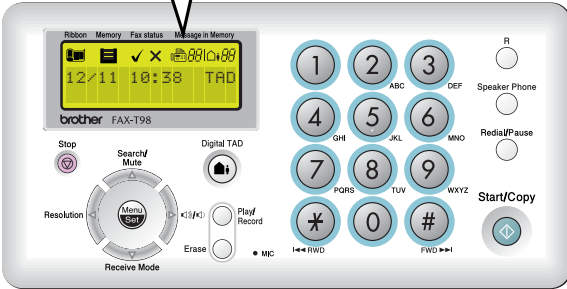
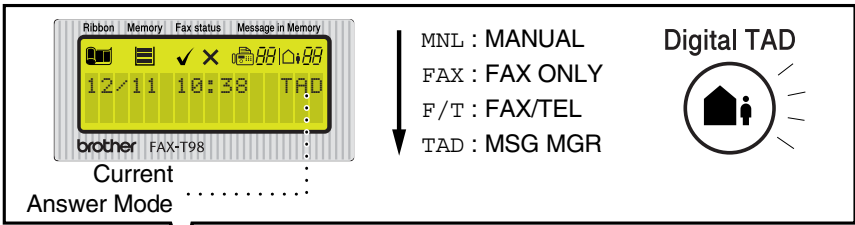

To select or change your Receive Mode

1 Press **Receive Mode**.

The screen displays your current selection. The options are:

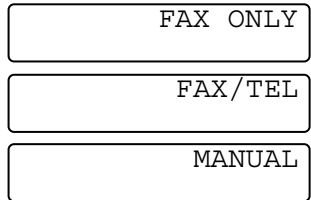

2 Continue to press **Receive Mode** until your new selection appears. After 2 seconds, the screen returns to the date and time display, along with your new Mode setting.



To switch TAD Mode ON or OFF press  (**Digital TAD** button). This overrides the setting chosen with the Mode key, so the display shows:

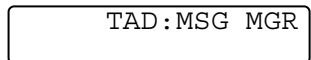

Setting the Ring Delay

The Ring Delay sets the number of times the fax machine rings before it answers in FAX ONLY, FAX/TEL or TAD mode.

1 Press **Menu/Set, 2, 1.**

1.RING DELAY

2 Press  or  to select RING DELAY.

Press **Menu/Set.**

3 Press **Stop.**





When Toll Saver is ON, it overrides your Ring Delay setting. Toll Saver must be off for the machine to operate using your Ring Delay setting. (See *Setting the Toll Saver* on page 8-10.)

Setting the F/T Ring Time (FAX/TEL mode only)

If you set the Receive Mode to FAX/TEL, you'll need to decide how long the fax machine will signal you with its special pseudo/double-ring when you have a voice call. (If it's a fax call, the fax machine prints the fax.) This ringing happens after the initial ringing from the phone company. Only the fax machine rings (for 20, 30, 40 or 70 seconds) and no other phones on the same line will ring with the special pseudo/double-ring. However, you can answer the call on any extension phone (in a separate wall socket) on the same line as the fax machine. (See *Operation from extension telephones* on page 5-8.)

1 Press **Menu/Set, 2, 2.**

2.F/T RING TIME

2 Press  or  to select how long the fax machine will ring to alert you that you have a voice call.

Press **Menu/Set.**





3 Press **Stop.**



Even if the caller hangs up during the pseudo/double-ringing, the fax machine will continue to ring for the set time.

Recording the Fax/Tel Outgoing Announcement (F/T MESSAGE)

This is the announcement played by your machine (not an external TAD) when someone calls and your machine is set to F/T mode. Although callers hear your announcement, they cannot leave a message.

- 1** Press **Menu/Set**, **8**, **3**.
- 2** Press  or  to select F/T MESSAGE, and press **Menu/Set**.
- 3** Press  or  to select RECORD MSG and press **Menu/Set**, then pick up the handset to record a message (up to 20 seconds).
- 4** Replace the handset. Your announcement is played.
- 5** Press **Stop** to exit.



It is not necessary to have an outgoing message. The F/T mode will work fine without one. It is only to help the caller understand the status of your machine.

For example, you can leave a message that says:

“Hello, please wait, we are trying to connect you. If you wish to send a fax, please wait until you hear a fax tone and press the Start key, or, press * **5 1** (your three-digit Fax Receive Code) and press the Start key.” See *Erasing the Outgoing Message (OGM)* on page 8-5 for directions on how to erase the announcement.



Fax Detect

When you use this feature, you don't have to press **Start/Copy** or the Fax Receive Code * 5 1 when you answer a fax call. Selecting **ON** allows the fax machine to receive fax calls automatically, even if you lift the handset of an extension or external phone. When you see **RECEIVE** on the LCD or when you hear "chirps" through the handset of an extension phone connected to another wall socket, just replace the handset and the fax machine will do the rest. **SEMI** lets the machine receive the call only if you've answered it at the fax machine. Selecting **OFF** means you'll have to activate the fax machine yourself by lifting the handset of the machine or an external phone, and then press **Start/Copy** on the fax machine—**OR**—by pressing * 5 1 if you are not at the fax machine. (See *Operation from extension telephones* on page 5-8.)



If this feature is set to **ON**, but the fax machine doesn't connect a fax call when you lift a phone handset, press the Fax Receive code * 5 1.

At the fax machine lift the handset, and then press **Start/Copy**.

- 1 Press **Menu/Set**, **2**, **3**.
- 2 Use  or  to select **ON**, **SEMI** or **OFF**.

3 . FAX DETECT



Press **Menu/Set**.

- 3 Press **Stop**.

Printing a reduced incoming fax

If you choose **AUTO**, the fax machine automatically reduces an incoming fax to fit on one page of A4, regardless of the paper size of the document.

1 Press **Menu/Set, 2, 5**.

2 Use  or  to select the reduction ratio you want—**AUTO**, 100%, 93%, 87%, or 75%. Choose 100% if you don't want a reduction.

5 . REDUCTION

Press **Menu/Set**.

3 Press **Stop**.



- If you receive faxes that are split onto two pages, turn on this setting.
- When you use Auto Reduction to reduce incoming documents to fit on one page of recording paper, you can do so only as long as the original document is not longer than 35 cm. If the original is longer than 35 cm, the data will not be reduced and will carry over to print on a second page.
- When you use Auto Reduction and you receive an incoming document that is smaller than your recording paper, no reduction will take place, and you will get the same size recorded as the original.

Reception into memory



As soon as the paper tray becomes empty during fax reception, the screen will display **CHECK PAPER**; please put some paper in the paper tray. (See Quick Setup Guide.)

If the Memory Receive is set to ON

If sufficient memory is available, the current fax reception will continue and remaining pages will be stored in memory. Subsequent incoming faxes will also be stored into memory until the memory becomes full, following which no further incoming fax calls will be answered automatically. To print all the faxes stored in memory, insert paper into the paper tray.

If the Memory Receive is set to OFF

If sufficient memory is available, the current fax reception will continue and remaining pages will be stored in memory, subject to available memory. Subsequent incoming faxes will not be answered automatically until fresh paper is put in the paper tray.

- 1 Press **Menu/Set**, **2**, **6**.
- 2 Use  or  to select ON (or OFF).
Press **Menu/Set**.
- 3 Press **Stop**.

6.MEM.RECEIVE

Receiving a fax at the end of a conversation

At the end of a conversation you can ask the other party to fax you information before you both hang up.

- 1 Ask the other party to place the document in their machine and to press the start key. Tell the other party to wait until the fax machine sends receiving tones (chirps) before hanging up.
- 2 When you hear the other machine's CNG tones (beeps), press **Start/Copy**.
The LCD shows:
- 3 Replace the handset.

RECEIVE

Advanced receiving operations

Operation from extension telephones

If you answer a fax call on an extension telephone, or an external telephone into the correct socket (See *Connections* on page 1-9.), you can make the fax machine take the call by using the Fax Receive Code. When you press the Fax Receive Code * 5 1, the fax machine starts to receive a fax.

(See *Fax Detect* on page 5-5.)

If the fax machine answers a voice call and pseudo/double-rings for you to take over, use the Telephone Answer Code # 5 1 to take the call at an extension phone. (See *Setting the F/T Ring Time (FAX/TEL mode only)* on page 5-3.)

If you answer a call and no one is on the line, you should assume that you're receiving a manual fax.

- At an extension phone (on a separate telephone wall socket, press * 5 1, wait for fax-receiving tones (chirps), and then hang up.
- At an external phone (connected to the correct socket), press * 5 1 and wait for the phone to be disconnected before you hang up (the LCD shows RECEIVE).

Your caller will have to press Start to send the fax.

For FAX/TEL mode only

When the fax machine is in FAX/TEL mode, it will use the F/T Ring Time (pseudo/double-ringing) to alert you to pick up a voice call.

If you're at an extension or external phone, you'll need to lift the handset during the F/T Ring Time and then press # 5 1 between the double rings. If no one is on the line, or if someone wants to send you a fax, send the call back to the fax machine by pressing * 5 1.

Remote Call Transfer

In order to set the Fax Receive, you should first set **Menu/Set, 2, 4** REMOTE CODE to ON. (See *Changing Remote Codes* on page 5-10.)

This function works when you receive the incoming Voice call at the remote DECT cordless phone externally connected to the fax machine. (See *Connecting an external telephone* on page 1-9.) You can transfer voice call to the fax machine. But you cannot transfer the incoming voice call from the fax machine to the DECT cordless phone.

To transfer a telephone call to the fax machine

When you pick up the voice call at the remote DECT cordless phone and would like to transfer it to the fax machine,

- 1 Press DECT Activation Code * **8 1** at remote cordless phone.
- 2 The fax machine rings (pseudo-ring same as current F/T ring) and the display shows "PICK UP PHONE".
- 3 Pick up the handset.

—OR—

Just press **Speaker Phone** at the fax machine in order to transfer the voice call to the fax machine.



Don't hang up the call from the cordless phone until the voice call has been transferred to the fax machine. You will know when this is because you will no longer be able to hear or talk to the caller via the cordless phone. If you do not wait until this point before hanging up from the cordless phone, the call will be lost.

If nobody answers at the fax machine, pseudo-ringing stops after 30 seconds. In that case, it may still be possible to speak with the caller from the cordless phone. Speech between the fax machine and the cordless phone (= intercom) is not possible.



Changing Remote Codes

Remote Codes might not work with some telephone systems. The preset Fax Receive Code is * **5 1**. The preset Telephone Answer Code is # **5 1**. The preset DECT Activation Code is * **8 1**.



If you are always disconnected when accessing your external TAD remotely, try changing the Fax Receive Code from * **5 1** to # # # and the Telephone Answer Code from # **5 1** to **1 1 1**. You cannot use the same number for the Fax Receive Code and the Telephone Answer Code.

To change Remote Codes

- 1** Press **Menu/Set**, **2**, **4**.
- 2** Press  or  to select **ON** (or **OFF**), and press **Menu/Set** when the screen displays the setting you want.
- 3** If you want to, enter a new Fax Receive Code, then press **Menu/Set**.
- 4** If you want to, enter a new Telephone Answer Code, then press **Menu/Set**.
- 5** If you want to, enter a new DECT Activation Code, then press **Menu/Set**.
- 6** Press **Stop** to exit.

Polling

Polling is the process of retrieving faxes from another fax machine. You can use the fax machine to 'poll' other machines, or you can have someone poll the fax machine.

Everyone who is involved in Polling needs to set up their fax machines for Polling. When someone polls the fax machine to receive a fax, they pay for the call. If you poll someone's fax machine to receive a fax, you pay for the call.



Some fax machines do not respond to the Polling feature.



Secure Polling

Secure Polling is a way to keep your documents and others from falling into the wrong hands while the machine is set up for polling. You can use Secure Polling only with another Brother fax machine. Anyone who polls to receive a fax must enter the polling secure code.

Setting up Polling Receive

Polling Receive is when you call another fax machine to receive a fax from it.

1 Press **Menu/Set, 2, 7**.

2 Press  or  to select STANDARD.



Press **Menu/Set**.

3 Enter the fax number you are polling. Press **Start/Copy**.

7.POLLING RX



Setup for Polling Receive with Secure Code

You need to make sure you are using the same secure code as the other party.

- 1** Press **Menu/Set, 2, 7.**
- 2** Press  or  to select **SECURE.**
Press **Menu/Set.**
- 3** Enter a four-digit secure code.
This is the same as the security code of the fax machine you are polling.
- 4** Press **Menu/Set.**
- 5** Enter the fax number you are polling.
- 6** Press **Start/Copy.**

Setup Delayed Polling Receive

You can set the machine to begin Polling Receive at a later time.

- 1** Press **Menu/Set, 2, 7.**
- 2** Press  or  to select **TIMER.**
Press **Menu/Set.**
- 3** The screen prompts you to enter the time you want to begin polling.
- 4** Enter the time (in 24-hour format) you want to begin polling.
For example, enter 21:45 for 9:45 PM.
- 5** Press **Menu/Set.**
- 6** The screen prompts you to enter the fax number you are polling and then to press **Start/Copy.**
The machine makes the polling call at the time you entered.







You can set up only one Delayed Polling.

Sequential Polling

Your machine can request documents from several fax units in a single operation. You just specify several destinations in Step 4. Afterward, a Sequential Polling Report will be printed.

- 1** Press **Menu/Set, 2, 7**. The screen displays.

POLLING: STANDARD SELECT ↑ ↓ & SET

- 2** Press  or  to choose STANDARD, SECURE or TIMER, and press **Menu/Set** when the screen displays the setting you want.
- 3** If you selected STANDARD, go to step 4.
 - If you selected SECURE, enter a four-digit number and press **Menu/Set**, and then go to step 4.
 - If you selected TIMER, enter the time (in 24-hour format) you want to begin polling and press **Menu/Set**, and then go to step 4.
- 4** Press **Search/Mute**. Then, select the destination by pressing  or  and press **Menu/Set**.
- 5** Repeat Step 4 to enter the next number.
- 6** Press **Start/Copy**.

Your machine polls each number in turn for a document.

Telephone Services

Your FAX supports the Caller ID and BT Call Sign (For U.K. Only) telephone services offered by some telephone companies.

Caller ID (Caller Identification) (U.K. Only)

Caller ID is a telephone service that allows the subscriber to see a display of the caller's phone number as the telephone rings. It is a fast way to screen your calls. You can respond quickly to calls you missed, because Caller IDs are received and stored in your machine's memory. In addition to the standard Caller ID features, you can select a Caller ID and have your machine dial the number for you.



- To get the Caller ID Service: apply for the Caller ID service at your local telephone company, if available.

- To PABX Users:

Calling line identification signals are not generally delivered to your Brother fax machine if it is connected behind a private automatic branch exchange (PABX) system or other call routing device.

Advantages of Caller ID

For Business



All businesses profit from a quicker response to customer calls.

At Home

Residential customers can protect themselves from unwanted calls by seeing the callers name or number before they answer.

Set the Caller ID to ON

If you have BT Caller ID on your line, then this function should be set to ON to display the caller's phone number on the fax LCD as the telephone rings.

- 1 Press **Menu/Set, 0, 1.**
- 2 Press  or  to choose ON (or OFF).
Press **Menu/Set.**
- 3 Press **Stop.**

1 . CALLER ID

How Does the Caller ID Work?

The Caller ID Appears on the Display When Your Telephone Rings

As your telephone rings, the screen displays the caller's phone number. If the caller's name is stored in your machine as a Speed Dial, or One Touch dial, the caller's name will be displayed. Once you pick up the handset, the caller's ID disappears. TELEPHONE/FAX will appear on the display.



- If # UNAVAILABLE appears on the display, it means that the call came from outside your caller ID service area. *
- If # WITHHELD appears on the display, it means the caller intentionally blocked the transmission of his/her ID. *
- If no caller ID was transmitted to your fax machine, PICK UP PHONE will remain on the display.
* Depends on network Function.

The Caller ID is Stored in Your Machine's Memory

The machine can store a maximum of the last 30 incoming caller IDs in the memory, along with the time and date of reception. The 31st call will cause the oldest ID to be erased.

The Caller ID information stored in the memory can be used for the following.

■ **Selecting a Caller ID from the Memory for Call Reply.**

You can scroll through the Caller IDs on the display and select one for your machine to dial. (See *Selecting a Caller ID from the Memory for Call Reply* on page 5-17.)

■ **Printing the Caller ID List.**

You can review calls you received by checking the Caller IDs in memory. This report will list the Date, Time, Phone Number (Caller ID), and type of call (Comment).



Please set up the number of rings to more than 02 in the Ring Delay (see *Setting the Ring Delay* on page 5-3) before you use the Caller ID. If you set up the number of rings to 01, you cannot receive the Caller ID.

Selecting a Caller ID from the Memory for Call Reply



You can display the caller IDs that are stored in the memory and select the caller you want your machine to dial. Call Reply is a convenient feature whereby your Brother fax can dial back a voice/fax call “on-hook” to the opposite party associated with a Caller ID number which has been captured into memory. This saves you from having to copy and dial back to that number manually.

1 Press **Menu/Set, 0, 1**.

2 Press  or  to select **DISPLAY ID**, and press **Menu/Set**.

DISPLAY ID

The caller ID of the last call will appear on the display. If no ID is stored, the beeper will sound and **NO CALLER ID** will appear on the display.

3 Press  or  to scroll through the Caller IDs in the memory, and press **Menu/Set** to automatically dial the Caller ID number. Wait until the screen prompts you to press the **Start/Copy** key.

4 Press **Start/Copy**.

DIALING

—OR—

If you wish to send a fax, insert a document into the ADF. Then press **Start/Copy**.

TELEPHONE

To cancel the Call Reply (for example, when you selected the Wrong Caller ID), simply press **Stop** and begin again; the Caller ID will not be lost.

To Activate Certain Network Services When Using Call Reply



You may wish (in order to activate certain network services), to insert a special prefix to be dialled in front of the Caller ID number when using the Call Reply feature. For example,

You can withhold your outgoing Caller ID.

The required prefix, typically three to six digits (including # and * symbols) in length, may be inserted after displaying the desired Caller ID in step 3 on the previous page. (You can enter the prefix up to 20 digits on the machine.) The complete number string including the prefix will then be dialled by pressing **Start/Copy**.

Select the desired Caller ID, wait 2 seconds until you see the date and time the caller ID was received.

25) 09/11 15:25

Enter the prefix by using number keys up to 20 digits.

DIAL:PRESS START

- The display will be cleared when you press any of the number keys.
- To cancel the prefix (such as when you entered the wrong number), simply press **Stop**.

The display will return to the desired Caller ID you selected.

- If you press **Stop** again, the machine will return to the current date and time display. You are no longer in the call reply mode.
- Any problems or queries in using network services should be raised in the first instance with your network operator(s).
- With Call Reply, automatic redial does not function in cases where the called party is busy or doesn't answer.



Call Reply to DDI numbers via Caller ID

Calls derived from a caller ID number to destinations connected to a "Direct Dial Inward (DDI)" private exchange system may fail to connect, or may be answered in the first instance by the called premises main switchboard rather than by the intended extension. Brother is not liable for any call charges thus incurred.

Clearing the Caller ID Stored in Memory

For the effective use of the memory, it is recommended that you should clear the Caller ID stored into memory by pressing **Erase** when the screen displays the number.

Printing Caller ID List

- 1** Press **Menu/Set, 0, 1**.
- 2** Press  or  to select **PRINT REPORT**, and press **Menu/Set**.
- 3** Press **Stop**.

BT Call Sign (For U.K. Only)

This machine feature lets you use the BT Call Sign subscriber service which allows you to have at least two separate telephone numbers on one phone line. Each phone number has its own distinctive ringing pattern, so you know which phone number is ringing. This is one way you can have a separate phone number for your machine.

Your machine has a BT Call Sign compatible distinctive ringing function, allowing you to dedicate a second phone number (on the same phone line) just for receiving faxes.



You can switch it off temporarily, then turn it back on. When you get a new fax number, make sure you reset this function.



When you set the BT Call Sign feature to ON, the receive mode is set to **MANUAL** automatically. (If your setting is TAD mode, the receive mode doesn't change.) You cannot change the receive mode to the other mode while the BT Call Sign is set to on.

To enable the machine to work with BT Call Sign (Only with your external phone)

1 Press **Menu/Set**, **0**, **2**.

The screen displays the current setting of this feature.

2 Press  or  to select **ON** (or **OFF**).

3 Press **Menu/Set**.

4 Press **Stop**.



If you turn off the BT Call Sign, receive mode stays **MANUAL**. You need to set receive mode again.

6 Setup Send

How to dial



There are four ways to dial.

Manual dialling

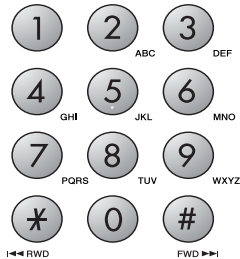
Press all of the digits of the phone or fax number.



Search

You can search for names you have stored in TEL-Index memories. Press **Search/Mute**, and then press  or  to search for numbers alphabetically.

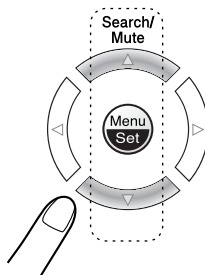

How to fax

Automatic transmission

This is the easiest way to send a fax.

IMPORTANT: Do not pick up the handset or press **Speaker Phone**.

- 1 Insert the document face down, top edge first in the ADF.
- 2 Adjust the paper guides to fit the width of your document.

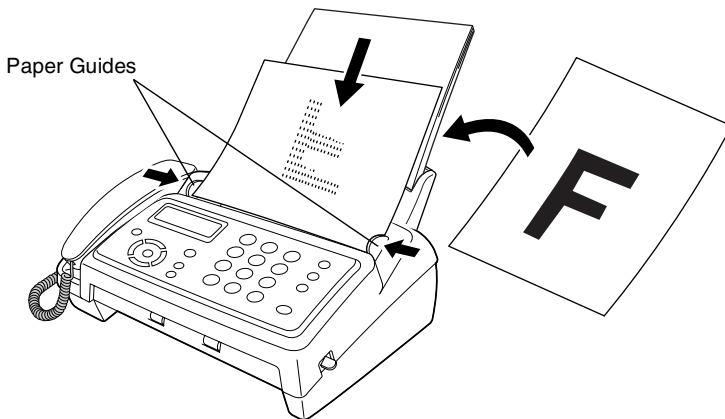

- 3 Enter the fax number using Search or the dial pad.
 - 4 Press **Start/Copy**.
- ⊘ Do not use paper that is curled, wrinkled folded, ripped, stapled, paper clipped, pasted or taped.
Do not use cardboard, newspaper, or fabric.



- The documents to be faxed must be from 148 mm to 216 mm wide and 150 to 600 mm long.
- The ADF can hold up to 10 pages, feeding each one individually through the fax machine. Use standard 64 g/m²~90 g/m² paper when using the ADF; if you are using heavier paper, feed each sheet individually to prevent paper jams.
- Your machine cannot scan anything closer than 4 mm from the edge of the paper.
- Press **Resolution** (before you send the fax) to select the resolution for the document you are sending. If you wish to send in STANDARD resolution, i.e. a general fax with no graphics, then the default is STANDARD, and the resolution button need not be pressed. (See *Fax resolution* on page 6-6.)



Manual transmission

Manual transmission lets you hear the dialling, ringing and fax-receiving tones while sending a fax.

- 1 Insert the document face down in the ADF.
- 2 Pick up the handset and listen for a dial tone.

—OR—

Press **Speaker Phone** and listen for a dial tone.

- 3 Enter the fax number you want to call. (You can enter the digits using the dial pad, or you can call using **Search/Mute** and  or .)
- 4 When you hear the fax tone, press **Start/Copy**.
- 5 If you're using the handset, hang up.

SEND

Sending a fax at the end of a conversation

At the end of a conversation you can send a fax to the other party before you both hang up.

- 1** Ask the other party to wait for fax tones (beeps) and then press **Start** before hanging up.
- 2** Insert the document face down in the ADF.
Press **Start/Copy**.
The LCD shows:
- 3** Replace the handset.

SEND

Basic sending operations

Sending faxes using multiple settings

When you send a fax you can choose any combination of these settings such as contrast, resolution, overseas mode, delayed fax timer, polling transmission or memory transmission. After each setting is accepted, the LCD will ask if you want to enter more settings:

Press **1** to select more settings. The LCD will return to the **SETUP SEND** menu.

—OR—

Press **2** if you have finished choosing settings and go to the next step.

Contrast

If your document is very light or very dark, you may want to set the contrast.

Use **LIGHT** to make the document darker.

Use **DARK** to make the document lighter.

- 1** Insert the document face down in the ADF.

3 . CONTRAST

Press **Menu/Set, 3, 3**.

- 2** Press  or  to select **AUTO, LIGHT** or **DARK**.

Press **Menu/Set**.

- 3** Press **1** if you want to choose more settings and the LCD will return to the **SETUP SEND** menu.

ACCEPTED

—OR—

NEXT
1 . YES 2 . NO

Press **2** if you have finished choosing settings for this page, and then go to **Step 4**.

- 4** Enter a fax number.
- 5** Press **Start/Copy** to send the fax.



Fax resolution

When you have a document in the ADF you can use the **Resolution** key to change the setting temporarily (for this fax only). Press **Resolution** repeatedly until the LCD shows the setting you want.

- STANDARD _____ Suitable for most typed documents.
- FINE _____ Good for small print and transmits a little slower than Standard resolution.
- S . FINE _____ Good for small print or artwork and transmits slower than Fine resolution.
- PHOTO _____ Use when the document has varying shades of gray. This has the slowest transmission time.

Multiple Resolution Transmission

Use this feature to select separate resolution settings for each page of the fax you are sending. This could be useful if you are sending a fax with photos and letters, or some pages with small print and others with normal print. Resolution settings return to STANDARD after the fax is sent.

- 1** Insert the document face down in the ADF.
Press **Menu/Set, 3, 4.**
- 2** Press  or  to select resolution for page 1.
Press **Menu/Set.**
- 3** Repeat Step 2 for subsequent pages. Press **Stop** when you are finished. The screen displays:

ACCEPTED

NEXT
1 . YES 2 . NO

4 Press **1** if you want to select additional settings. The display returns to the Setup Send menu.

—OR—

Press **2** if you have finished choosing settings, and then go to Step 5. The screen prompts you to enter the fax number you want to call.

5 Enter a fax number.

6 Press **Start/Copy** to send the fax.



If you want to copy a document using multiple resolutions, press **Start/Copy** in Step 5.

Manual and automatic fax redial

If you are sending a fax manually and the line is busy, press **Redial/Pause**, and then press **Start/Copy** to try again. If you want to make a second call to the last number dialed, you can save time by pressing **Redial/Pause** and **Start/Copy**.

Redial/Pause only works if you dialed from the control panel.

If you are sending a fax automatically and the line is busy, the fax machine will automatically redial three times at five minutes intervals.

Cancelling a job while scanning, dialling and sending the document

You can cancel a job while you are scanning it by pressing **Stop**.

You can also cancel a job while the fax machine are dialling or sending the document by pressing **Stop**.



Cancelling a scheduled job

You can cancel a fax job that is waiting in memory.

1 Press **Menu/Set**, **4**.

Any jobs that are waiting will appear on the LCD.

4 . CANCEL JOB

2 If you have more than two jobs waiting, press  or  to select the job you want to cancel.

Press **Menu/Set**.

—OR—

If you only have one job waiting, go to Step 3.

3 Press **1** to cancel.

—OR—

Press **2** to exit without cancelling.

To cancel another job go to Step 2.

4 Press **Stop**.

Advanced sending operations

Electronic Cover Page

The cover page is sent to the receiving party's machine. Your cover page includes the name stored in the Index memory, if you have used a quick-dial number to make the call.

The cover page indicates the fax is from your Station ID, and the number of pages you are sending. If you have COVERPG SETUP set to ON (see *Always send Cover Page* on page 6-11), the number of pages on the cover page remains blank.

You can select a comment to include on your cover page, or you can select

1 . COMMENT OFF if you do not wish to include a comment.

As well as using one of the comments shown on the right, you can also enter up to two customized messages, each 27 characters long.

(See *Composing your own comments* on page 6-12.)

1 . COMMENT OFF

2 . PLEASE CALL

3 . URGENT

4 . CONFIDENTIAL

Cover Page for Next Fax Only

Make sure Station ID is set up. (See *Setting the Station ID* on page 4-2.) This feature does not work without the Station ID.



You can set the fax to send a cover page with a particular document. This cover page will include the number of pages in your document.

1 Insert the document face down in the ADF.

2 Press **Menu/Set**, **3**, **1**.

1. COVERPG SETUP

3 Press **Menu/Set** when the screen displays NEXT FAX ONLY.

4 Press  or  to select ON (or OFF), and press **Menu/Set**.

5 Press  or  to view the comment selections.

6 Press **Menu/Set** when the screen displays your selection.

7 Enter two digits to indicate the number of pages you are sending. (Enter 00 to leave the number of pages blank.) If you have made a mistake, press  to back up and re-enter the number of pages.

8 Press **Menu/Set**. The screen displays:

ACCEPTED

9 Press **1** if you want to select additional settings. The display returns to the Setup Send menu.

NEXT
1. YES 2. NO

—OR—

Press **2** if you are finished choosing settings, and go to Step 10.

10 Enter the fax number you are calling and then press **Start/Copy**.



Always send Cover Page

Make sure Station ID is set up. (See *Setting the Station ID* on page 4-2.) This feature does not work without the Station ID.



You can set your machine to send a cover page whenever you send a fax. The number of pages in your fax is not included when you use this setting.

1 Press **Menu/Set, 3, 1.**

1 . COVERPG SETUP

2 Press  or  to select ON (or OFF).

3 Press **Menu/Set** when the screen displays COVERPAGE : ON. (If you select ON, a coverpage is always sent when you send a fax.)

4 If you selected ON, the screen displays the cover page comment options. Press  or  to view comment selections.

5 Press **Menu/Set** when the screen displays your selection. The screen displays:

ACCEPTED

6 Press **1** if you want to select additional settings. The display returns to the Setup Send menu.

NEXT
1 . YES 2 . NO

—OR—



Press **2** to exit if you are finished choosing settings.

Using a printed Cover Page

If you prefer using a printed cover page that you can write on, you can print the sample page and attach it to your fax.

1 Press **Menu/Set, 3, 1.**



1 . COVERPG SETUP

2 Press  or  to select PRINT SAMPLE, and press **Menu/Set.**

Composing your own comments

1 Press **Menu/Set, 3, 2**. The screen displays:

2 . COVERPAGE NOTE

2 Use  or  to choose position 5 or 6 for your customized comment.

Press **Menu/Set**.

3 Use the dial pad to enter your customized comment.
(See *Entering text* on page 4-3.)

4 Press **Menu/Set**. The screen displays:

ACCEPTED

5 Press **1** if you want to select additional settings. The display returns to the Setup Send menu.

NEXT
1 . YES 2 . NO

—OR—

Press **2** if you are finished choosing settings and exit.



Overseas Mode

If you are having difficulty sending a fax overseas due to possible interference on the phone line, we recommend that you turn on the Overseas Mode. After you send a fax using this feature, the feature will turn itself off.

1 Insert the document face down in the ADF.

2 Press **Menu/Set, 3, 5.**

5 . OVERSEAS MODE

3 Press  or  to select ON (or OFF).

ACCEPTED

Press **Menu/Set.**

4 Press **1** if you want to choose more settings and the LCD will return to the **SETUP SEND** menu.

NEXT
1 . YES 2 . NO

—OR—

Press **2** if you have finished choosing settings, and then go to Step 5.

5 Enter the fax number you're calling.

6 Press **Start/Copy.**

Call Reservation

You can send a fax and let the other party know that you want to speak to him after the fax transmission is completed. The other fax machine will ring as if it were receiving a telephone call; if the other party picks up the handset, your machine will ring. Lift the handset to have a conversation.

If you set Call Reservation and Call Back message to ON, your machine leaves a message if the other party does not answer.

1 Insert the document face down in the ADF.

2 Press **Menu/Set**, **3**, **6**.



6 . CALL RESERVE

The screen displays the current setting for Call Reservation.

3 Press  or  to select ON (or OFF).

Press **Menu/Set** when the screen displays your selection.

4 If you set Call Reservation to ON, the screen displays the current setting for Call Back Message.

Press  or  to select ON (or OFF).

Press **Menu/Set** when the screen displays your selection. The screen displays

ACCEPTED

5 Press **1** if you want to select additional settings. The display returns to the SETUP SEND menu.

NEXT
1 . YES 2 . NO

—OR—

Press **2** if you are finished choosing settings, and go to Step 6. The screen prompts you to enter the fax number you want to call.



6 Enter the fax number, and press **Start/Copy**.

7 If you've set Call Reservation to ON, pick up your handset if your machine rings.



You cannot use auto redial with Call Reservation. You cannot use Call Reservation with Delayed Transmission or with Polling. You must register your Station ID to set Call Back Message to ON.

Print Sample Call Back Message

- 1 Press **Menu/Set**, **3**, **6**.
- 2 Press  or  to select PRINT SAMPLE.
Press **Menu/Set**.

6 . CALL RESERVE

Delayed Fax

You can use this function to send a fax up to 24 hours later.

- 1 Insert the document face down in the ADF.
- 2 Press **Menu/Set**, **3**, **7**.
- 3 Enter the time you want the fax to be sent (in 24-hour format).
Press **Menu/Set**.

(For example, enter 19:45 for 7:45 PM.)

7 . DELAYED FAX

- 4 Press **1** to select DOC if you want your machine to scan the printed document at the time it is sent.

1 . DOC 2 . MEMORY

—OR—

Press **2** to select MEMORY.

ACCEPTED

- 5 Press **1** if you want to choose more settings and the LCD will return to the SETUP SEND menu.

NEXT
1 . YES 2 . NO

—OR—

Press **2** if you have finished choosing settings, and then go to Step 6.

- 6 Enter the fax number.
- 7 Press **Start/Copy**. The machine will wait until the time you have entered to send the fax.



The number of pages you can scan into the memory depends on the amount of data that is printed on each page.

Setting up Polled Transmission (Standard)

Polling Transmit is when you set up your fax machine to wait with a document so another fax machine can retrieve it.

1 Insert the document to be retrieved in the ADF.

2 Press **Menu/Set**, **3**, **8**. The screen displays

POLLING: STANDARD
SELECT ↑ ↓ & SET

3 Press  or  to choose STANDARD, and press **Menu/Set**.

1. DOC 2. MEMORY

4 Press **1** to select DOC if you want your machine to scan the printed document at the time it is polled.

ACCEPTED

—OR—

Press **2** to select MEMORY.

5 Press **1** if you want to select additional settings. The display returns to the SETUP SEND menu.

NEXT
1. YES 2. NO

—OR—

Press **2** if you are finished choosing settings and go to Step 6.

6 Press **Start/Copy**.

 If you prefer to have the document waiting in memory in Step 4, press **2** to select MEMORY. In that case, you do not have to interrupt the timer to send a fax. Additionally, the document can be polled by several fax machines as long as it is not deleted from the memory (**Menu/Set**, **4**).

(See *Cancelling a scheduled job* on page 6-8.)

Setup for Polling Transmit with Secure Code

When you set `POLLING: SECURE` to ON, anyone who polls your machine must enter the polling ID number.

1 Insert the document face down in the ADF.

2 Press **Menu/Set**, **3**, **8**.

3 Press  or  to choose `SECURE`, and press **Menu/Set**.

POLLING: SECURE
SELECT ↑ ↓ & SET

4 Enter a four-digit number, and press **Menu/Set**.

1 . DOC 2 . MEMORY

5 Press **1** to select `DOC` if you want your machine to scan the printed document at the time it is polled.

ACCEPTED

—OR—

Press **2** to select `MEMORY`.

6 Press **1** if you want to select additional settings. The display returns to the `SETUP SEND` menu.

NEXT
1 . YES 2 . NO

—OR—

Press **2** if you are finished choosing settings and go to Step 7.

7 Press **Start/Copy** and wait for the fax to be polled.



Memory Transmission

This feature allows the fax machine to scan a fax into its memory and send it as soon as the scan is complete. This way, you don't have to wait for the entire fax to be transmitted before you retrieve your document.

1 Insert the document face down in the ADF.

2 Press **Menu/Set, 3, 9**.

9.MEMORY TX



3 To change the default setting, press  or  to select ON (or OFF).

MEMORY TX: ON
SELECT ↑ ↓ & SET

Press **Menu/Set**.

Go to Step 5.

—OR—

For the next fax transmission only, press  or  to select NEXT FAX ONLY.

Press **Menu/Set**.

4 For the next fax only, press  or  to select ON (or OFF).

Press **Menu/Set**.

5 Press **1** to select additional settings. The display returns to the SETUP SEND menu.

—OR—

Press **2** if you are finished choosing settings and go to Step 6.

6 Enter fax number and press **Start/Copy**.

Out of memory message

If you get an **OUT OF MEMORY** message while scanning the first page of a fax, press **Stop** to cancel the scan. If you get an **OUT OF MEMORY** message while scanning a subsequent page, you will have the option to press **Start/Copy** to send the pages scanned so far, or to press **Stop** to cancel the operation.





Depending on your typical faxes, **OUT OF MEMORY** errors can occur frequently. If this happens, change the **Memory Transmission** setting back to **OFF**.

Broadcasting

Using the numbers you have stored in **Groups** and **Tel-Index** memory, you can “Broadcast” faxes automatically to a maximum of 100 different locations in a few simple steps.

After the Broadcast is completed, a **Broadcast Report** will be printed automatically to let you know the results.

- 1** Insert the document face down in the ADF.
- 2** Press **Menu/Set, 3, 9** to set **Memory Transmission ON**.
- 3** Press **Search/Mute**. Then, select the **Tel-Index** or **Group** number by pressing  or  and then press **Menu/Set**.
- 4** Repeat Step 3 to enter the next number.
- 5** Press **Start/Copy**. The fax machine stores the document in memory, and then transmits it to all the numbers you entered. If the line is busy, your machine will redial.



Press **Stop** during transmission to cancel the current fax Broadcast.

To cancel all locations, press **Menu/Set, 4**. (See *Cancelling a scheduled job* on page 6-8.)

Interrupting Delayed Fax and Polled Transmit jobs

You can send a fax or make a copy now, even if you have your machine set to send a fax later, or if you have it set to be polled. However, you cannot use automatic redial or the Menu mode.

1 Press **Menu/Set, 5**.

5 . INTERRUPT

2 Wait 2 seconds, then remove the documents that are waiting in the ADF.

3 Insert the document you want to send now in the ADF.

4 Enter the number for the fax you want to send now, and press **Start/Copy**.

5 After the transmission is finished, return the first document to the ADF.

6 Press **Menu/Set, 5** to restore the Delayed Fax.





If you set Delayed Fax or Polled Transmit using the memory (that is, if you have already scanned the document into your machine's memory and will send it from there), you don't have to interrupt to send a fax or make a copy.

7

Setup Index for Easy Dialling

Storing Tel-Index Numbers for Index

You can store Tel-Index numbers for Index, which you dial by pressing  or  and Start. There are 100 Tel-Index locations. Even if you lose electrical power, numbers stored in memory will not be lost.

- 1** Press **Menu/Set, 6, 1**.

The screen prompts you to enter the number you're storing.

1.SET TEL. INDEX

- 2** Enter the number (up to 20 digits).

TEL:
ENTER & SET

- 3** Press **Menu/Set**. The screen now prompts you to store a name with this number.



NAME:
ENTER & SET

- 4** Use the dial pad to enter the name (up to 15 characters). (See *Entering text* on page 4-3 to help you enter letters.)

—OR—

Press **Menu/Set** and go to Step 6 to store the number without a name.

- 5** Press **Menu/Set**.

- 6** The screen prompts you to select the type of number this is. Press  or  to select the type you want.

FAX a fax only number

TEL a telephone (voice) number

FAX/TEL both a fax and telephone (voice) number

- 7** Press **Menu/Set**.

- 8** Press **Menu/Set** and return to Step 2 to store another Tel-Index.



—OR—

Press **Stop** to exit.

Changing Tel Index Numbers for Index

You can change numbers or names stored in the memory. There are 4 Group Number locations.

1 Press **Menu/Set, 6, 2**.



2 Press  or  to select the number you want to change.

3 Press **Menu/Set**.

4 Enter a new number.



■ If you want to erase the number, press **Stop** when the cursor is to the far left of the digits.



■ If you want to change a digit, press  or  to position the cursor under the digit you want to change, then enter the new one.

5 Follow the directions in Storing Tel-Index Numbers for Index.

Storing Groups

After storing Tel-Index numbers, you can combine them into a Group. Groups allow you to send the same fax message to many fax numbers. You can have up to four small Groups or you can assign up to 100 numbers to one large Group.

1 Press **Menu/Set, 6, 3**.

2 Press  or  to select the number you want to store.

3 Press **Menu/Set** to accept the number for this Group.



■ Return to Step 2 and 3 to store another number for this Group.

■ Press **Erase** to erase the previous numbers you stored.

4 Press **Menu/Set**.



5 Use the dial pad to enter a name for the Group. (See *Entering text* on page 4-3.)

6 Press **Menu/Set**.



7 Press **Stop**.

Changing the Numbers for Groups





You can change and erase Group settings.

- 1** Press **Menu/Set**, **6**, **4**.
- 2** Press  or  to select the Group number you want to change.
- 3** Press **Menu/Set**.

When you change a Group name

- 4** Press  or  to select CHANGE NAME?.
- 5** Press **Menu/Set**.
- 6** Use the dial pad to enter a new name for the group. (See *Entering text* on page 4-3.)
- 7** Press **Menu/Set**.
- 8** Press **Stop**.

When you erase the numbers



- 4** Press  or  to select ERASE?.
- 5** Press **Menu/Set**.
- 6** Press  or  to select the number you want to erase.
- 7** Press **Menu/Set**.



Return to Step 6 to erase another number.

- 8** Press **Stop**.

When you add the numbers to a Group

- 4** Select ADD?.
- 5** Press **Menu/Set**.
- 6** Press  or  to select numbers you want to add.
- 7** Press **Menu/Set**.



Return to Step 6 to add another number for Group.

- 8** Press **Stop**.

Dialling options

You can use the fax machine to make voice telephone calls by dialling manually or by using Search. You can use the handset to make and receive calls.

When you dial a quick-dial number, the LCD shows the name you've stored, or if you haven't stored a name, the fax number you've stored.

Manual dialling

Manual dialling is simply pressing all of the digits of the phone number.

1 Pick up the handset.

—OR—

Press **Speaker Phone**.

2 When you hear a dial tone, dial the call using the dial pad.

3 To hang up, replace the handset.

—OR—

Press **Speaker Phone**.

On Hook Dialling

1 Dial the number by using the dial pad.



The number you are dialling is displayed on the LCD.

2 Press **Start/Copy**, and when the call is answered, you can now speak to the party at the other end without lifting the handset.

Press **Speaker Phone** when you finish the conversation.

Search

You can search for names you have stored.

- 1 Pick up the handset.
—OR—
Press **Speaker Phone**.
- 2 Press **Search/Mute**, then enter the first letter of the name you are looking for by using the dial pad.
- 3 Press  or  to search the names that are displayed alphabetically.
- 4 When the screen displays the name you want to call, press **Start/Copy** to begin dialling.
- 5 To hang up, replace the handset.
—OR—
Press **Speaker Phone**.

Answering Calls with the Speakerphone

When the machine rings, instead of lifting the handset, press **Speaker Phone**. Speak clearly, toward the microphone. To end the call, press **Speaker Phone**.

If you have a bad telephone line connection, the other party might hear your voice echoed during the call. Hang up and try the call again—OR—Pick up the handset.

Mute

- 1 Press **Search/Mute** to put a call on hold.
- 2 You can replace the handset without disconnecting the call.
- 3 Pick up the machine's handset or press **Speaker Phone** to release the call from hold.

If you press **Search/Mute** without lifting the handset or pressing **Speaker Phone**, this key works as the Search key.



You can select to play or not to play a music during a call put on hold. (See *Setting the Music on Hold* on page 4-8.)

Pause

Press **Redial/Pause** to insert a 3.5-second pause between numbers. If you are dialling overseas, you can press **Redial/Pause** as many times as needed to increase the length of the pause.

Redial (Tel)

If you are calling someone and the line is busy, you can retry the number by pressing **Redial/Pause**.

- 1 Pick up the handset.
—OR—
Press **Speaker Phone**.
- 2 Press **Redial/Pause**.
- 3 To hang up, replace the handset.
—OR—
Press **Speaker Phone**.

Redial (Fax)

If you're sending a fax manually and the line is busy, press **Redial/Pause** to try again. Any time you want to make a second call to the last number dialed, press **Redial/Pause** to save time.

If you're sending a fax automatically and the line is busy, the fax machine will automatically redial three times at five minute intervals after the transmission.

Tone or Pulse

If you have a Pulse dialling service, but need to send Tone signals (for example, for telephone banking), follow the instructions below. If you have Touch Tone service, you will not need this feature to send tone signals.

- 1** Pick up the handset.
- 2** Press **#**. Any digits dialed after this will send tone signals.
- 3** When you hang up, the fax machine will return to the Pulse dialling service.

8

Message Manager

Message Manager Mode

Message Manager Mode allows you to store incoming fax and voice messages in a flexible memory. The memory stores **15** minutes of voice messages, or up to **20** pages of fax messages. The actual number of pages stored in memory varies depending on the content and the resolution used. Memory is shared between fax and voice messages, which are stored on a “first-come, first-served” basis. Any voice or fax message can be retrieved remotely.

You must record an Outgoing Message in order to use the Message Manager Mode. (See *Recording the Message Manager's Outgoing Message (TAD MESSAGE)* on page 8-4.)

Setting Up Message Manager

You must set up Message Manager in the following order:

- 1** Set the Message Store.
- 2** Record the Message Manager's Outgoing Message (TAD MESSAGE).
- 3** Activate Message Manager (TAD) Mode by pressing .





Flexible Memory Settings (Message Store)

Message Manager Mode offers you six flexible memory settings, so that you can decide which kinds of messages you want to receive.

- 1. DOC:ON, VOICE:ON** Both voice and fax messages are stored. You can use the Fax Forwarding or Paging features and retrieve voice and fax messages remotely.
- 2. DOC:ON, VOICE:EXT** You need an external answering machine connected to the fax machine for this setting. (See *Connecting an external telephone answering device (TAD)* on page 1-10.) Fax messages are stored in the Message Manager memory, but voice messages are stored in your external answering machine. Retrieve voice messages from the external answering machine. You cannot use the Paging feature for voice message with this setting.
- 3. DOC:ON, VOICE:OFF** All memory is used to store fax messages—no voice messages will be stored.
- 4. DOC:OFF, VOICE:ON** All memory is used to store voice messages—no fax messages will be stored. Incoming faxes will be printed on paper. You can use the Paging feature, and retrieve voice messages remotely.
- 5. DOC:OFF, VOICE:EXT** You need an external answering machine connected to the fax machine for this setting. Incoming faxes are not stored in memory, but will be printed on paper. Voice messages are stored in the external answering machine.
- 6. DOC:OFF, VOICE:OFF** Incoming faxes are not stored in memory, but will be printed on paper. Voice calls are not stored in memory.

Setting the Message Store



Select the setting from the descriptions of “Flexible Memory Settings”.

- 1** Press **Menu/Set, 8, 1**. The screen prompts you to choose a DOC (Document) setting.
- 2** Press  or  to select ON (or OFF), and press **Menu/Set**.
- 3** The screen prompts you to choose a VOICE setting.
Press  or  to select your setting from the list (ON, OFF or EXT).
Press **Menu/Set**.
- 4** Press **Stop**.

Recording the Message Manager's Outgoing Message (TAD MESSAGE)

Recording the Message Manager's Outgoing Message (TAD MESSAGE) is the second step you need to follow before you can turn on the Message Manager. Make sure your OGM (Outgoing Message) is less than 20 seconds long.



1 Press **Menu/Set**, **8**, **3**. The screen prompts you to choose an OGM.

2 Press  or  to reach TAD MESSAGE.



This is the only setting you can select if you want to turn the Message Manager on.

3 Press **Menu/Set**.

4 Press  or  to select RECORD MSG.

Press **Menu/Set**.







5 Pick up the handset to record a message.

For example: Hello. We are unable to take your call at this time. Please leave a message after the signal. If you wish to send a fax, please press *51, wait for the fax tones, then press the start button on your machine.





6 Press **Stop** and replace the handset. The Message Manager plays your OGM.

7 Press **Stop**.

Listening to the Outgoing Message (OGM)

- 1 Press **Menu/Set, 8, 3.**
- 2 Press  or  to select TAD MESSAGE (or F/T MESSAGE or PAGING MSG.).
Press **Menu/Set** when the screen displays your selection.
- 3 Press  or  to select PLAY MSG and press **Menu/Set.**
Adjust volume by pressing  or .
- 4 Press **Stop.**

Erasing the Outgoing Message (OGM)

- 1 Press **Menu/Set, 8, 3.**
- 2 Press  or  to select TAD MESSAGE (or F/T MESSAGE or PAGING MSG.).
Press **Menu/Set.**
- 3 Press  or  to select ERASE MSG.
Press **Menu/Set.**
- 4 Press **1** to erase the OGM.
—OR—
Press **2** to exit without erasing.
- 5 Press **Stop.**

Activating Message Manager Mode

Press and hold  until the button lights and the screen displays
TAD : MSG MGR.

When  light is out, the Message Manager is off. (See *Setting Up Message Manager* on page 8-1.)

Message Indicator

The  light flashes when you have new messages and/or faxes waiting for your review.

The LCD Indicator shows the total number of voice (including recorded conversations) and/or fax messages stored in Message Manager memory.

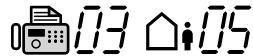

If you press the flashing  to turn off the Message Manager before getting your new messages, they won't be lost. The new messages will be played automatically and the LCD will ask you to acknowledge the new faxes:

PRINT DOC?
1. YES 2. NO

Press **1** to print (and automatically delete) the faxes from memory.

—OR—

Press **2** to save the faxes in memory until printing is convenient.

What Happens When the Memory Is Full...



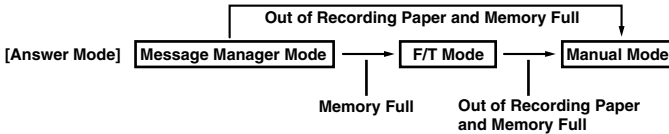

If the memory becomes full when you have set your machine to Message Manager mode, the machine will change to F/T mode automatically. In this mode, the machine can accept incoming faxes automatically. Then, if your machine should run out of paper, the answer mode will shift automatically to manual mode. In manual mode the call is not answered, so your caller will know to try again later.



Print the Memory Status List and select the item to be cleared. Clear the item to get space for new messages and faxes to be stored in memory. (See *Printing reports* on page 9-1.)

Playing Voice Messages

Follow the steps below to listen to voice messages.

- 1** Press **Play/Record**. Adjust volume by pressing  or . All new messages are played in the order they were recorded. The screen displays the number of the current message, and the total number of messages. If Caller ID information was received, the machine beeps during the message and displays the Caller ID information for one second. During playback, the screen displays the time and date the message was recorded.
- 2** Press * (RWD) at the end of the message to repeat a message. Use # (FWD) to skip to the next message. You can press * and # repeatedly until you reach the message you want to play.
- 3** Press **Stop**.

Printing a Fax Message



Once you print a new fax message stored in memory, it is erased from the memory automatically.

- 1** Press **Play/Record**. After two seconds, the machine begins to play voice messages.
- 2** After playing voice messages, the display asks if you want to print fax messages that are in the memory. There is no display if there are no faxes.

PRINT DOC?
1 . YES 2 . NO
- 3** To print the fax messages, press **1**.
—OR—
Press **2** to exit without printing.

Backup Printing Option

When you choose `DOC : ON` in the Message Manager mode, all incoming fax messages are stored in the available memory for retrieval. To print a backup copy automatically, turn this option on.

- 1** Press **Menu/Set**, **8**, **2**. The screen prompts you to select a setting.
- 2** Press  or  to display `ON` (or `OFF`).
Press **Menu/Set**.
- 3** Press **Stop**.

Erasing Messages

If you choose to erase all fax messages, the machine will print any previously unprinted fax messages before erasing them from memory. Fax messages cannot be erased individually.

You can erase voice messages individually, or all at once.



To erase voice messages individually

- 1 Press **Play/Record**. The machine beeps and begins message playback. Each message is preceded by one long beep, and followed by two short beeps.
- 2 To erase a specific message, press **Erase** immediately after the two short beeps, or while the message is playing. The screen prompts:

ERASE THIS MSG.?
1.YES 2.NO
- 3 Press **1** to erase the message.
—OR—
Press **2** to exit without erasing.
- 4 Press **Stop**.



To erase messages all at once

- 1 Press **Erase**. The screen prompts you to choose what kind of messages you want to erase.

ERASE ALL VOICE?
SELECT ↑ ↓ & SET
- 2 Press  or  to select erasing all voice messages (**ALL VOICE**), all document messages (**ALL DOC.**), or all messages—both voice and fax—(**ALL MSG.**).
Press **Menu/Set**.
- 3 Press **1** to erase.
—OR—
Press **2** to exit without erasing.

Setting the Maximum Time for Incoming Messages

The default time for receiving voice messages is up to 35 seconds long. You can change this setting to any length from 35 seconds to 60 seconds in 5-second increments.





- 1** Press **Menu/Set, 8, 4**. The screen prompts you to select a maximum time.
- 2** Press  or  to select the maximum time setting for incoming messages.
Press **Menu/Set**.
- 3** Press **Stop**.

Setting the Toll Saver

When you set the Toll Saver feature, the machine answers after 5 rings if you don't have messages, and after 3 rings if you do have messages. This way, when you call the machine, if it rings 4 times, you know you have no messages, and can hang up, avoiding any toll/call charge.





When Toll Saver is **ON**, it overrides your Ring Delay setting. Toll Saver must be off for the machine to operate using your Ring Delay setting. (See *Setting the Ring Delay* on page 5-3.)

- 1** Press **Menu/Set, 2, 1**.
- 2** Press  or  to select **TOLL SAVER**.
Press **Menu/Set**.
- 3** Press  or  to select **ON** (or **OFF**).
Press **Menu/Set**.
- 4** Press **Stop**.

ICM Recording Monitor

This feature lets you turn OFF (or ON) the speaker volume for voice messages. When you turn the monitor OFF, you will not hear messages as they come in.

- 1** Press **Menu/Set, 8, 5**.
- 2** Press  or  to select OFF (or ON).
Press **Menu/Set**.
- 3** Press **Stop**.

Recording a Conversation

You can record a telephone conversation by pressing **Play/Record** during the conversation. Your recording can be as long as the Incoming Message Maximum Time. The other party will hear a beep every 15 seconds while recording. You cannot record a conversation using the Speakerphone.

Fax Forwarding/Paging



When Paging is set to ON, your machine dials the pager number you have programmed and, when connected, the Paging OGM message you have recorded is repeated for 60 seconds. This activates your pager and lets you know you have a fax or voice message in the Message Manager memory.

When Fax Forwarding is set to ON, your machine dials the fax machine phone number you've programmed, and forwards any faxes you've received.



You cannot use Paging and Fax Forwarding at the same time.

Programming a Fax Forwarding Number

- 1 Press **Menu/Set, 8, 6**.
- 2 Press  or  until the screen displays **FAX FORWARD**. Press **Menu/Set**.

The screen prompts you to enter the number of the fax machine where faxes will be forwarded.





- 3 Enter the forwarding number (up to 20 digits), and press **Menu/Set**.
- 4 Press **Stop**.



You can change a Fax Forwarding number remotely.

Recording the Paging Outgoing Message (OGM)



Before paging can work, you should first record the Paging OGM.

- 1** Press **Menu/Set, 8, 3**. The screen prompts you to choose an OGM.
- 2** Press  or  to reach **PAGING MSG..**
Press **Menu/Set**.
- 3** Press  or  to select **RECORD MSG.**
Press **Menu/Set**.
- 4** Pick up the handset to record a message.
- 5** Press **Stop** and replace the handset. The Message Manager plays your OGM.
- 6** Press **Stop**.



You can delete or play the Paging message in the same way as the TAD Message. (See *Recording the Message Manager's Outgoing Message (TAD MESSAGE)* on page 8-4.)

Programming the Paging Number

- 1** Press **Menu/Set, 8, 6**.
- 2** Press  or  until the screen displays **PAGING.**
Press **Menu/Set**.
The screen prompts you to enter your pager number.
- 3** Enter your paging number up to 20 digits.
Press **Menu/Set**.
This is the telephone number which your machine must call.
- 4** Press **Stop**.



You cannot change a Paging number remotely.

Remote Retrieval

You can call your machine from any touch tone phone (or remote Group 3 fax machine set for tone) and use a Remote Access Code and Remote Control Commands to retrieve voice (and fax) messages. You can also program and change some settings for your Message Manager.

Using the Remote Access Code

- 1** Dial your machine phone number from a touch tone phone.
- 2** When your machine answers and beeps, immediately enter your Remote Access Code.
- 3** The machine signals the following kinds of messages received.
 - 1 long beep—Fax message(s)**
 - 2 long beeps—Voice message(s)**
 - 3 long beeps—Fax and Voice message(s)**
 - No beeps—no messages**
- 4** The machine then prompts you with two short beeps to enter a command. If you wait longer than 30 seconds to enter a command, the machine hangs up. If you enter an invalid command, the machine beeps three times.
- 5** Press **9 0** to reset the machine when you finish.
- 6** Hang up.

Changing the Remote Access Code

The remote access code lets you access the Remote Retrieval features when you are away from the fax machine. Before you use the remote access and retrieval features, you have to set up your own code. The default code is inactive code (--- *).

1 Press **Menu/Set, 8, 7**.

2 Enter a three-digit code using number keys 0-9, * and #.

Press **Menu/Set**.

The * cannot be changed. Do not use the same digits that appear in your Fax Receive Code, Telephone Answer Code or DECT Activation Code.

3 Press **Stop**.



You can change your code at any time by entering a new one.

If you want to make your code inactive, press **Stop** in Step 2 to restore the inactive setting (--- *).

Remote Control Commands

Follow the commands below to access features remotely. When you call the fax machine and enter your Remote Access Code (3 digits followed by *), the system will signal you with two short beeps to enter a remote control command.

Remote control commands		Detail Operation
91 Playing voice messages		After one long beep, the machine plays ICM.
	1 Skip back	Press 1 while listening to an ICM to play it again. If you press 1 before a message, you will hear the previous message.
	2 Skip next	While playing ICM, you can skip to next message.
	9 STOP Playing	Stop playing the ICM.
93 Erase all ICM		If you hear one long beep, the erase is accepted. If you hear three short beeps, you cannot erase because all voice messages have not been played, or there is no voice message to erase. *This code erases all recorded messages, not one at a time.
94 Play and Record OGM in memory		
1 Play	1 TAD MSG	The machine plays the selected OGM. You can stop playing OGMs by pressing 9 .
	2 F/T MSG	
	3 PAGING MSG	
2 Record	1 TAD MSG	After one long beep, you can record the selected OGM. You will hear the message played once. You can stop recording the message by pressing 9 .
	2 F/T MSG	
	3 PAGING MSG	

Remote control commands	Detail Operation				
95 Changing Fax Forwarding/Paging setting <table border="1" data-bbox="221 245 423 515"> <tr> <td data-bbox="221 245 423 285">1 OFF</td> </tr> <tr> <td data-bbox="221 285 423 325">2 Fax Forwarding</td> </tr> <tr> <td data-bbox="221 325 423 365">3 Paging</td> </tr> <tr> <td data-bbox="221 365 423 515">4 FAX FWD NO.</td> </tr> </table>	1 OFF	2 Fax Forwarding	3 Paging	4 FAX FWD NO.	<p>If you hear one long beep, the change is accepted. If you hear three short beeps, you cannot change it because the conditions have not been met (Example: registering paging number).</p> <p>You can register your fax forwarding number by using 4.FAX FWD NO. (See <i>Changing the Fax Forwarding Number</i> on page 8-20.) Once you have registered the number, the machine will automatically turn to "FAX FWD:ON" mode. Then retrieve a Memory Status List by entering 9 6 1 to make sure that the Fax Forwarding number you registered is correct in the List.</p>
1 OFF					
2 Fax Forwarding					
3 Paging					
4 FAX FWD NO.					
96 Retrieve Fax <table border="1" data-bbox="221 555 423 735"> <tr> <td data-bbox="221 555 423 627">1 Memory Status List</td> </tr> <tr> <td data-bbox="221 627 423 667">2 Retrieve all FAX</td> </tr> <tr> <td data-bbox="221 667 423 735">3 Erase FAX in the memory</td> </tr> </table>	1 Memory Status List	2 Retrieve all FAX	3 Erase FAX in the memory	<p>Enter the number of a remote fax machine to receive a report or stored fax messages. (See <i>Retrieving the Memory Status List</i> on page 8-18 and <i>Retrieving Fax Messages</i> on page 8-19.)</p> <p>If you hear one long beep, you can erase the fax message from the memory.</p>	
1 Memory Status List					
2 Retrieve all FAX					
3 Erase FAX in the memory					
97 Check the receiving status <table border="1" data-bbox="221 804 423 884"> <tr> <td data-bbox="221 804 423 844">1 Document</td> </tr> <tr> <td data-bbox="221 844 423 884">2 Voice</td> </tr> </table>	1 Document	2 Voice	<p>You can check whether your fax machine has received any Document or Voice messages. If yes, you will hear one long beep. If no, you will hear three short beeps.</p>		
1 Document					
2 Voice					
98 Change Answer Mode <table border="1" data-bbox="221 927 423 1043"> <tr> <td data-bbox="221 927 423 967">1 TAD</td> </tr> <tr> <td data-bbox="221 967 423 1007">2 FAX/TEL</td> </tr> <tr> <td data-bbox="221 1007 423 1043">3 FAX</td> </tr> </table>	1 TAD	2 FAX/TEL	3 FAX	<p>If you hear one long beep, you can change the answer mode. If you hear three short beeps, you cannot change it. (Example: There is no TAD MSG when you want to change to TAD mode.)</p>	
1 TAD					
2 FAX/TEL					
3 FAX					
90 Exit	<p>After a long beep, you can exit remote control.</p>				

Retrieving the Memory Status List

You can retrieve the Memory Status List from a remote fax machine to see if you have any fax messages.

- 1** Dial your fax machine's number.
- 2** When you hear the beep, immediately enter your Remote Access Code (3 digits followed by *).
- 3** When you hear two short beeps, use the dial pad to press **9 6 1**.
- 4** Using the dial pad, enter the number (up to 20 digits) of the remote fax machine where you want the Memory Status List forwarded, and then press **# #**.



You cannot use * and # as dial numbers. However, if you want to store a pause, press #.

- 5** After you hear your fax machine beep, hang up and wait.
Your fax machine calls the remote fax machine and sends the Memory Status List. The remote fax machine prints the List.

Retrieving Fax Messages

- 1** Dial your fax machine's number.
 - 2** When you hear the beep, immediately enter your Remote Access Code (3 digits followed by *).
 - 3** As soon as you hear two short beeps, use the dial pad to press **9 6 2**.
 - 4** Using the dial pad, enter the number (up to 20 digits) of the remote fax machine where you want your fax messages forwarded, and then press **# #**.
-  You cannot use * and # as dial numbers. However, if you want to store a pause, press #.
- 5** After you hear your fax machine beep, hang up and wait. Your fax machine calls the remote fax machine and sends the stored documents. The remote fax machine prints your fax messages.

Changing the Fax Forwarding Number

The default setting or a fax forward number that has been previously stored can be changed from a remote fax machine.

- 1** Dial your fax machine's number.
- 2** When you hear the beep, immediately enter your Remote Access Code (3 digits followed by *).
- 3** When you hear two short beeps, use the dial pad to press **9 5 4**.
- 4** Enter the new number of the remote fax machine where you want your fax messages forwarded, and then press **# #**.



You cannot use * and # as dial numbers. However, if you want to store a pause, press #. Also, if your fax machine is connected to a PABX, you can press # first before the fax machine's number. The # works as well as **R** key.

- 5** To retrieve the Memory Status List, when you hear two short beeps, use the dial pad to press **9 6 1**.
- 6** Use the dial pad to enter the number of the remote fax machine (up to 20 digits), and then press **# #**.
- 7** After you hear your fax machine beep, hang up and wait.
Your fax machine calls the remote fax machine. Your fax machine then sends the Memory Status List showing the new forwarding number to the remote fax machine.
- 8** Check the forwarding number.

If the forwarding number is incorrect, return to Step 1 to reset it.

9 Printing reports

Printing reports

You can print the following lists and reports:

1.HELP LIST	Lists basic operational steps and menu selections.
2.XMIT REPORT	Choose if Transmission Verification Report is printed after all Faxes sent.
3.FAX JOURNAL	Journal lists information about the last 30 incoming and outgoing faxes. TX means Transmit; RX means Receive.
4.TEL. INDEX	Tel-Index list, alphabetically.
5.USER SETTINGS	Lists settings such as INITIAL SETUP, SETUP RECEIVE and SETUP TAD.
6.MEMORY STATUS	Lists summary information and amount of occupied memory.

Setting Reports

To Print a Report



- 1 Press **Menu/Set**, **7**.
- 2 Enter the number (see list above) of the report you want to print. For example, press **5** to print the **USER SETTINGS**.
(To print the Journal manually press **3** and **Menu/Set**.)
- 3 Press **Start/Copy**.
- 4 Press **Stop** to exit.

Customizing the Transmission Verification (Xmit) Report

You can use the Xmit Report as proof that you sent a fax. This report lists the time and date of transmission and whether the transmission was successful (OK). If you select ON, the report will print for every fax you send.



When the feature is OFF, the Report will only print if there is a transmission error. (NG).

- 1 Press **Menu/Set**, **7**, **2**.
- 2 Press  or  to select ON or OFF.
Press **Menu/Set**.
- 3 Press **Stop**.

2.XMIT REPORT

Setting the Journal Period

You can set the fax machine to print Fax Journal at specific intervals (every 30 faxes, 6, 12 or 24 hours, 2 or 7 days). If you set the journal period to OFF, you can print the report by following the steps on the next page.

The default setting is EVERY 30 FAXES.

1 Press **Menu/Set, 7, 3.**

3 . FAX JOURNAL

2 Press  or  to choose a journal period.

Press **Menu/Set.**

(If you choose 7 days, the LCD will ask you to choose a day on which to begin the 7-day countdown.)

3 Enter the time to begin printing in 24-hour format.

Press **Menu/Set.**

(For example: enter 19:45 for 7:45 PM.)

4 Press **Stop.**



If you select 6, 12, 24 hours, 2 or 7 days, the fax machine will print the report at the selected time and then erase all jobs from its memory. If the fax machine's memory becomes full with 30 jobs before the time you selected has passed, the fax machine will print the Journal Period early and then erase all jobs from memory. If you want an extra report before it is due to print, you can print it without erasing the jobs from memory.

10 Making copies

Using the fax machine as a copier

You can use this fax machine as a copier. Always make sure you have paper in the paper tray before making copies.



 Incoming faxes cannot be received on paper or into the memory while the fax machine is copying.

Copy operations

To make a single copy that is not reduced, enlarged or sorted, you only have to press one key. Remember, your machine cannot scan anything closer than 4 mm from the edge of the paper.

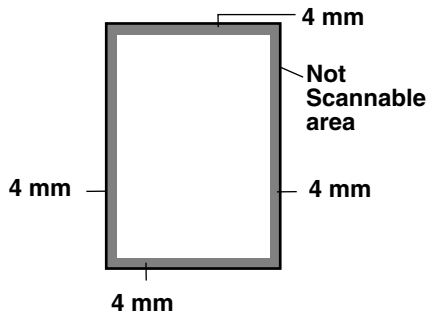

Making a single copy

1 Insert the document face down in the ADF.

2 Press **Start/Copy** twice.

To cancel, press **Stop**.

Do NOT pull on the paper while copying is in progress.



The default resolution for a single copy is *S.FINE*. Set the resolution to *PHOTO* for photographs by using the **Resolution** key.

Copy options: Single or Multiple copies, Sort/Stack, Reduce/Enlarge

You can choose additional copy options. First, you can select the number of copies. Next, when you select the number of copies more than 1, you can choose whether multiple copies will be *STACKED* (all copies of page 1, then all copies of page 2, etc.) or *SORTED* (collated). Finally, you can choose an enlargement or reduction ratio. To reduce to the size of A4 recording paper automatically, select *AUTO*. To reduce the copy by a fixed percentage, choose 93%, 87%, 75% or 50%. Or, to enlarge the copy, select 150%, 125% or 120%. To copy a document at its original size, select 100%.

1 Place the original face down in the ADF.

FAX: NO. & START
COPY: PRESS COPY

2 Press **Start/Copy**.

NO.OF COPIES:01
THEN COPY OR SET

3 Enter the number of copies you want (1-99).



NO.OF COPIES:09
THEN COPY OR SET

For example: Press 9 for nine copies.

MULTI COPY:STACK
SELECT ↑ ↓ & SET

To start copying now, press **Start/Copy**.

If you would like to select additional copy options, like sort, enlarge or reduce, press **Menu/Set**.

- 4 Press  or  to select SORT or STACK.



MULTI COPY : SORT
SELECT ↑ ↓ & SET

For example: Select SORT.

To start copying now without enlarging or reducing, press Start/Copy.

SORT P.01 FNE

To reduce or enlarge the image, press Menu/Set.

- 5 Press  or  to select an enlargement or reduction ratio.

ELG/RDC : 100%
SELECT ↑ ↓ & SET

ELG/RDC : 120%
SELECT ↑ ↓ & SET

⋮

ELG/RDC : 75%
SELECT ↑ ↓ & SET

For example: 75%.

ELG/RDC : 75%
SELECT ↑ ↓ & SET

- 6 Press **Start/Copy**.

SORT P.01 FNE

 If you are making multiple copies and get a **OUT OF MEMORY** message while you are scanning the first page, press **Stop** to cancel the job. Then make a single copy. If you selected **SORT** and the **OUT OF MEMORY** message appears while scanning subsequent pages, you can press **Start/Copy** to copy the portion that is in memory, or press **Stop** to cancel. To restart the copy job using less memory, press **Start/Copy** for stacked copies.

 The default resolution for multiple copies or reducing and enlarging copies is **FINE**. Set the resolution to **S.FINE** for small print or artwork and **PHOTO** for photographs by using the **Resolution** key. **S.FINE** and **PHOTO** resolutions use up more memory than **FINE** mode.

11 Important information

Important Safety Instructions

- 1 Read all of these instructions.
- 2 Save them for later reference.
- 3 Follow all warnings and instructions marked on the product.
- 4 Unplug the fax machine from the wall outlet before cleaning. To clean the casing of the fax machine use a damp cloth, do not use liquid or aerosol cleaners. To clean the interior, see *Routine maintenance* on page 12-10.
- 5 Do not use this product near water.
- 6 Do not place this product on an unstable cart, stand, or table. The product may fall, causing serious damage to the product.
- 7 Slots and openings in the cabinet and the back or bottom are provided for ventilation; to ensure reliable operation of the product and to protect it from overheating, these openings must not be blocked or covered. The openings should never be blocked by placing the product on a bed, sofa, rug, or other similar surface. This product should never be placed near or over a radiator or heater. This product should never be placed in a built-in installation unless proper ventilation is provided.
- 8 This product should be operated from the type of power source indicated on the label. If you are not sure of the type of power available, consult with your dealer or local power company.
- 9 This product is equipped with a 3-wire earthed plug. This plug will fit into only an earthed socket. This is a safety feature. If you are unable to insert the plug into the outlet, contact your electrician to replace your obsolete socket. Do not defeat the purpose of an earthed plug.

- 10** Do not allow anything to rest on the power cord. Do not place this product where people can walk on the cord.
- 11** If an extension cord is used with this product, make sure that the total ampere ratings on the products plugged into the extension cord do not exceed the extension cord ampere rating. Also, make sure that the total of all products plugged into the wall or floor socket does not exceed the socket rating.
- 12** Do not place anything in front of the machine that will block received faxes. Do not place anything in the path of received faxes.
- 13** Do not touch a document during printing.
- 14** Never push objects of any kind into this product through cabinet slots, since they may touch dangerous voltage points or short out parts resulting in a risk of fire or electric shock. Never spill liquid of any kind on the product.
- 15** Do not attempt to service this product yourself, as opening or removing covers may expose you to dangerous voltage points and/or other risks. Refer all servicing to service personnel.
- 16** This product has no mains ON/OFF switch. It is therefore highly important that access to the mains plug and the mains socket to which the plug is connected, is never obstructed, in case for some reason the mains power to the machine must be quickly disconnected.

- 17** Unplug this product from the mains power and telephone line sockets, and refer servicing to qualified Service Personnel under the following conditions:
- When the power cord is damaged or frayed.
 - If liquid has been spilled into the product.
 - If the product has been exposed to rain or water.
 - If the product does not operate normally when the operating instructions are followed. Adjust only those controls that are covered by the operating instructions. Improper adjustment of other controls may result in damage and will often require extensive work by a qualified technician to restore the product to normal operation.
 - If the product has been dropped or the cabinet has been damaged.
 - If the product exhibits a distinct change in performance, indicating a need for service.

18 To further protect your product against power surges, we recommend the use of a power protection device (Surge Protector). This device is not supplied with this product, and can be found at any reputable Electrical, and Electronic outlet.

Trademarks

The Brother logo is a registered trademark of Brother Industries, Ltd.

Brother is a registered trademark of Brother Industries, Ltd.

© Copyright 2003 Brother Industries, Ltd. All rights reserved.

All other brand and product names mentioned in this manual are registered trademarks of their respective companies.

12 Troubleshooting and routine maintenance

Troubleshooting

IMPORTANT

For technical help, you must call the country where you bought the fax machine. Calls must be made **from within** that country.

Error messages

As with any sophisticated office product, errors may occur. If this happens, the fax machine identifies the problem and displays an error message. The most common error messages are shown below.

ERROR MESSAGES		
ERROR MESSAGE	CAUSE	ACTION
BT CALL SIGN ON	The machine is set BT Callsign to ON. You cannot change the Receive Mode from Manual to another mode.	Set BT Callsign to OFF. (See <i>BT Call Sign (For U.K. Only)</i> on page 5-20.)
CHECK DOCUMENT	The documents were not inserted or fed properly, or were too long. (See <i>Document Jam</i> on page 12-3.)	Insert the document again.
CHECK PAPER	The fax machine is out of paper.	The fax machine is out of paper or paper is not properly loaded in the paper tray. Refill the paper or remove the paper and load it again. If this error appears while receiving a fax, load paper to restart printing. If you were coping or printing reports, load paper and try again. (See <i>Paper Jam</i> on page 12-4.)
COMM. ERROR	Poor phone line quality caused a communication error.	Try the call again. If the problem continues, call the telephone company and ask them to check your phone line.
CONNECTION FAIL	You tried to poll a fax machine that is not in Polled Waiting mode.	Check the other fax machine's polling setup.

ERROR MESSAGES		
ERROR MESSAGE	CAUSE	ACTION
COOLING DOWN	The print head has overheated.	Wait 30 minutes for it to cool.
COVER OPEN	The cover is not closed completely.	Close the cover.
DISCONNECTED	The other person or other person's fax machine stopped the call.	Try to send or receive again.
MACHINE ERROR XX	The fax machine has a mechanical problem.	Unplug the machine. Then contact your Brother dealer for service.
NO RESPONSE/BUSY	The number you dialed does not answer or is busy.	Verify the number and try again.
OUT OF MEMORY	You can't store data in the memory.	<p>(Fax sending in process) Press Stop and wait until the other operations in progress finish and then try again.</p> <p>—OR— Clear the data in the memory. (See <i>Out of memory message</i> on page 6-19.)</p> <p>(Copy operation in process) Press Stop and wait until the other operations in process finish and then try again.</p> <p>—OR— Clear the data in the memory. (See <i>Out of memory message</i> on page 6-19.)</p>
PAPER JAM	The paper is jammed in the fax machine.	(See <i>Printer Jam or Paper Jam</i> on page 12-3.)

Printer Jam or Paper Jam

Document Jam

The documents were not inserted or fed properly, or were too long.

- 1** Remove any paper that is not jammed from the ADF.
- 2** Open the top cover by lifting the lever on the right side of the top cover.
- 3** Pull the document toward the front of the fax machine.
- 4** Close the top cover.

Press down on both sides of the top cover until it clicks.

Document is jammed.

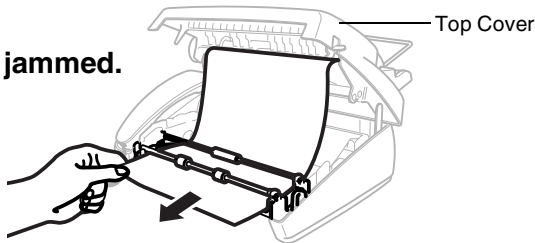

Paper Jam

The paper is jammed in the fax machine.

- 1 Remove any paper that is not jammed.

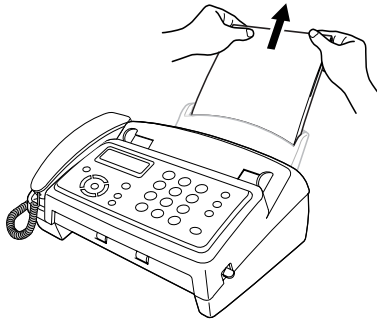

- 2 Open the top cover by lifting the lever on the right side of the top cover.

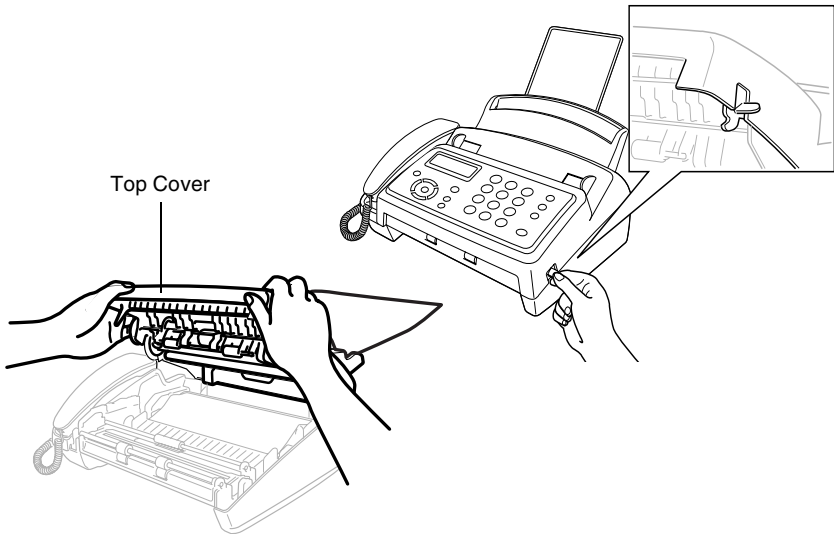

- 3** Pull the jammed printout gently from the paper tray toward the *front* of your fax machine. If the paper is jammed on exit then still pull the printout toward the *front* of your fax machine.

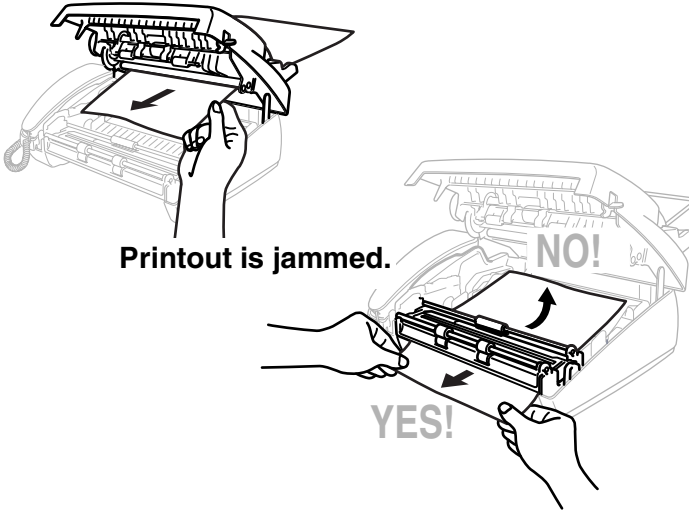

- 4** Remove the print cartridge and turn the spool to tighten the ribbon.
- 5** Install the cartridge. (See *Changing the ribbon* on page 12-11.)
- 6** Close the top cover.
Press down on both sides of the top cover until it clicks.
- 7** Put the paper back into the paper tray.

If you are having difficulty with the fax machine

If you think there is a problem with the way your faxes look, *make a copy first*. If the copy looks good, the problem is probably not the fax machine. Check the chart below and follow the troubleshooting tips.

DIFFICULTY	SUGGESTIONS
Printing or Receiving Faxes	
Condensed print and white streaks across the page or the top and bottom of sentences are cut off.	If your copy looks good, you probably had a bad connection, with static or interference on the phone line. If the copy looks bad, clean the scanner area. If there is still a problem, call Brother or your dealer for service.
Vertical black lines when receiving.	The sender's scanner may be dirty. Ask the sender to make a copy to see if the problem is on with the sending machine. Try receiving from another fax machine. If the problem continues, call Brother or your dealer for service.
Phone Line or Connections	
The fax machine does not answer when called.	Make sure the fax machine is in the correct receiving mode for your setup. (either FAX ONLY or F/T) Check for a dial tone. If possible, call the fax machine to hear it answer. If there is still no answer, check the telephone line cord connection. Connect a standard telephone handset to the fax machine's telephone socket. If there is no ringing when you call the fax machine, ask your telephone company to check the line.
External telephone answering device (TAD) does not answer when called	Connect the telephone line cord from your TAD to the correct socket. Make sure the TAD is set to answer calls. (See <i>Connecting an external telephone answering device (TAD)</i> on page 1-10.)
No dial tone on the handset	Press Speaker Phone — OR —Lift the handset. If you don't hear a dial tone, check telephone line cord connections at the fax machine and wall socket. Check that the handset is connected to the fax machine's handset socket. Test the wall socket with another single line telephone. If there is no dial tone at the wall outlet, call your telephone company.
Sending Faxes	
Poor sending quality.	Try changing your resolution to FINE or S.FINE . Make a copy to check the fax machine's scanner operation.
Dialling does not work	Check all line cord connections. Check power cord connection. Send a manual fax by pressing Speaker Phone or by lifting the handset and dialling the number. Wait to hear fax receiving tones before pressing Start/Copy .
Vertical black lines when sending.	Use the fax machine to make a copy. If the copy shows the same problem, the scanner area is dirty. Lift the top cover and check the document path. Clean the scanner's white roller and the glass strip under the roller using isopropyl alcohol and a lint-free cloth. (See <i>Cleaning the scanner</i> on page 12-10.)

DIFFICULTY	SUGGESTIONS
Handling Incoming Calls	
Double-ring in FAX/TEL mode	The fax machine knows the incoming call is not a fax so it is signaling you to answer the telephone call. Pick up the fax machine handset or answer from an extension phone, and then press the fax machine's Telephone Answer Code (default setting is #51). (See <i>For FAX/TEL mode only</i> on page 5-8.)
Transferring a call to the fax machine	If you have answered the fax machine handset, press Start/Copy and hang up immediately. If you answered at an extension phone, press your three-digit Fax Receive Code (default setting is *51). When the fax machine answers, hang up.
Fax machine "hears" voice as fax tone	If the fax machine is set to Fax Detect ON, it is more sensitive to sounds. The fax machine may mistakenly interpret certain voices or music on the line as a calling fax machine and respond with fax receiving tones. Deactivate the fax by pressing #51 if you are at an extension phone or press Stop if you are at the fax machine or an external phone. Try avoiding this problem by turning FAX DETECT to OFF. (See <i>Fax Detect</i> on page 5-5.)
Transmission Verification Report prints "Result: ERROR"	There is probably temporary noise or static on the phone line. Try sending the fax again. If the problem continues, call the telephone company to check your phone line.
Custom features on a single line.	If you have Call Waiting, Ring Master, Voice Mail, an alarm system or any other custom feature on a single phone line with the fax machine, it may create a problem sending or receiving fax data. For example: If you are sending or receiving a fax message while a custom feature signal comes through on the line, the signal can temporarily interrupt or disrupt the fax data. Brother's ECM feature should help overcome this problem. This condition is related to the telephone system industry and is common to all devices that send and receive data on a single, shared line with custom features. If avoiding a slight interruption is crucial to your business, we recommend a separate phone line with no custom features.

How to improve print quality

Cleaning the print head



WARNING

After you have just used the machine, some internal parts of the machine are extremely **HOT!** So please be careful.

- 1 Unplug the power cord for safety.
- 2 Open the top cover by lifting the lever on the right side of the top cover.
- 3 Take out the printing cartridge.

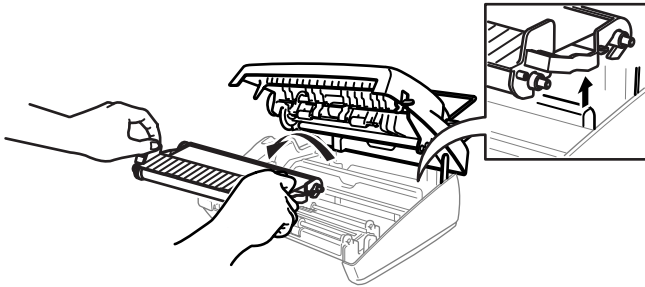

Be careful not to cut yourself on the sharp edges of the metal part shown in the illustration.

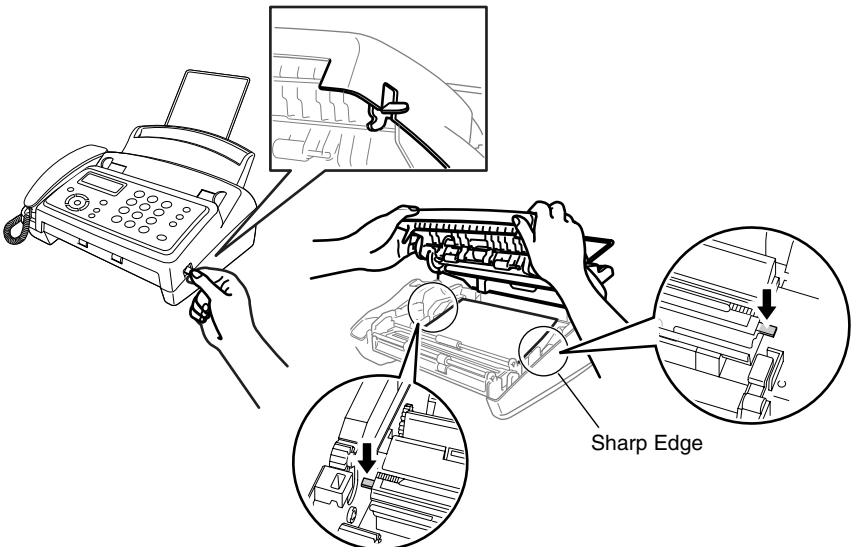

- 4** To clean your machine's print head, wipe the print head with a lint-free cloth that is dry or lightly moistened with isopropyl alcohol.

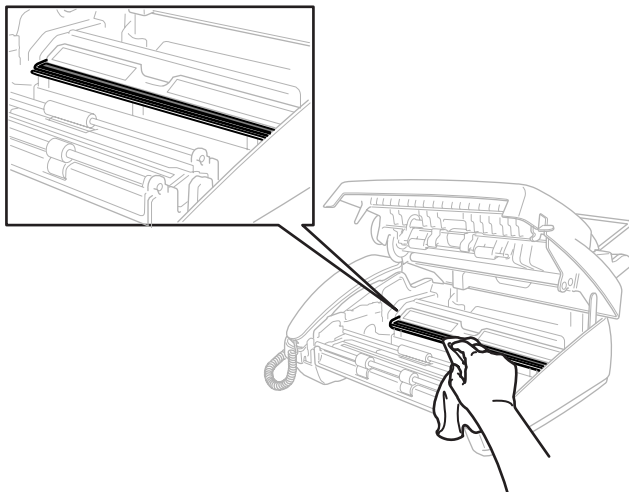

- 5** Wait until the alcohol on the print head is totally dried.
- 6** Install the printing cartridge. (See *Changing the ribbon* on page 12-11.)
- 7** Close the top cover.
Press down on both sides of the top cover until it clicks.

Routine maintenance

Cleaning the scanner

- 1** Unplug the power cord for safety.
- 2** Open the top cover by lifting the lever on the right side of the top cover.
- 3** Clean the white bar and the glass strip under the bar with isopropyl alcohol on a lint-free cloth. Be careful not to drop anything into the fax machine.

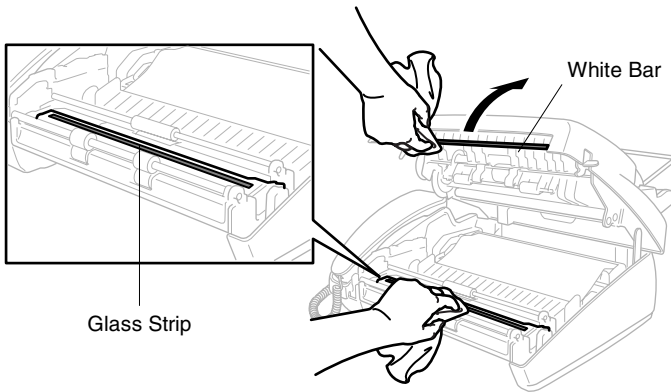

- 4** Close the top cover.
Press down on both sides of the top cover until it clicks.

Changing the ribbon

The  sign informs you of the status of remaining ribbon, and warns you if it is almost running out. The starter ribbon prints up to 30 pages.

 This sign means remaining ribbon will be 100% - 50%.

 This sign means remaining ribbon will be under 49% - 20%.

 This sign means remaining ribbon will be under 19% - 1%.

 This sign means remaining ribbon will be 0%.

Change used ribbon immediately. (See *Accessory List* on page A-1.)

- 1 Open the top cover by lifting the lever on the right side of the top cover.

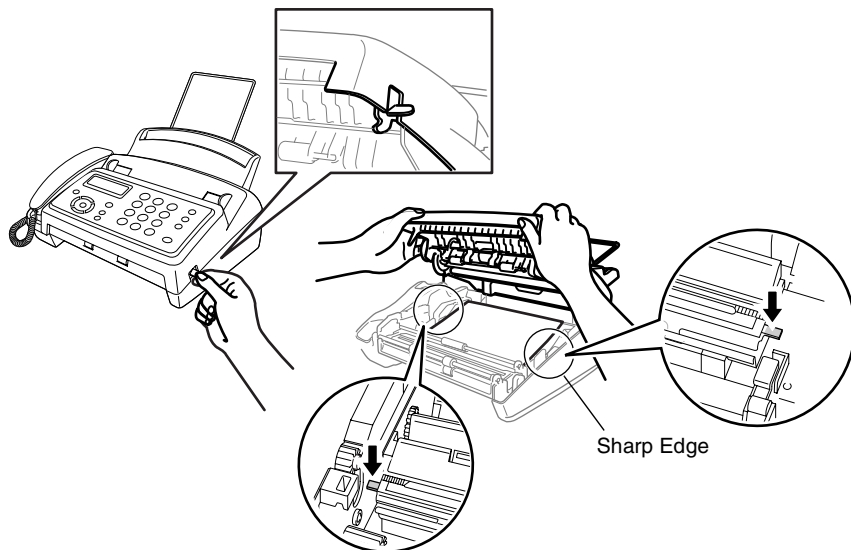

 Be careful not to cut yourself on the sharp edges of the metal part shown in the illustration.

- 2** Remove the print cartridge containing the used ribbon and set it upside-down with the blue gear in the upper left corner.

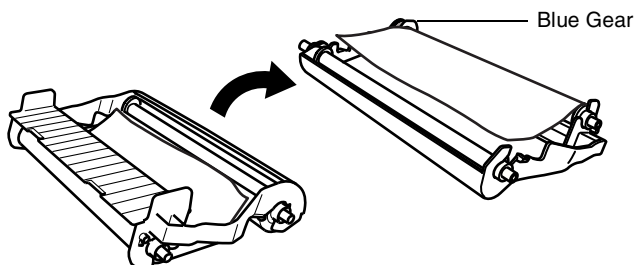

- 3** Take the used ribbon out of the cartridge:
- ① Unclip the upper white spool and slide the roll off the blue gear. (Do not remove the blue gear)
 - ② Lift out the lower roll.

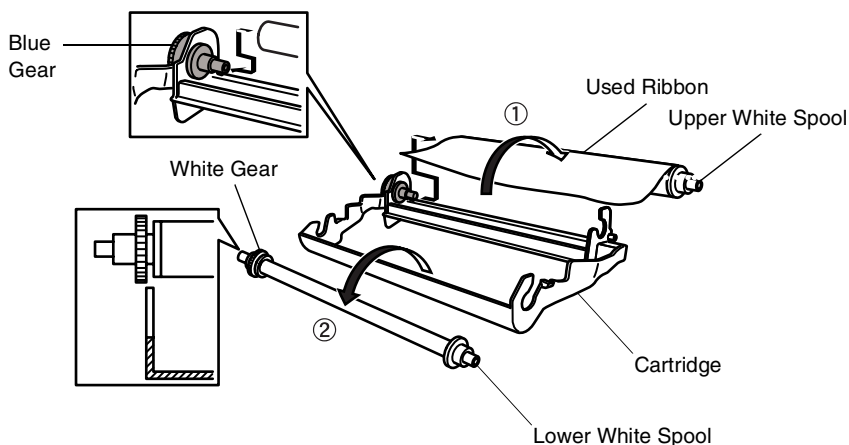

- 4** Slide the white elastic off the new refill rolls and set them down with the full roll in the lower position. (The ribbon's shiny side is facing *down*.)

- 5** Remove the white gear and spools from the ends of the used cardboard cores. Then insert them into the same positions in the new cores.

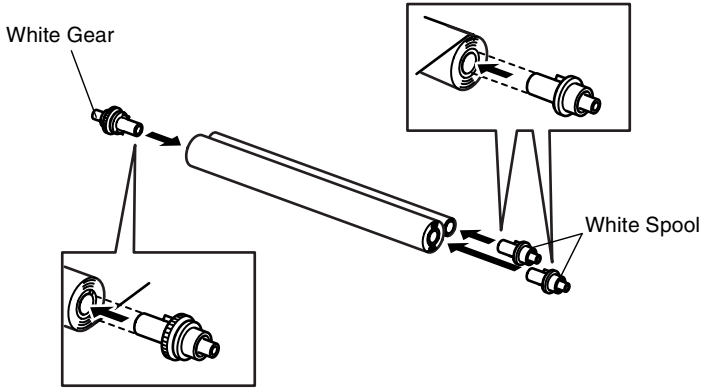

- 6** Install the new ribbon in the cartridge:

- ① Insert the lower roll into the cartridge holders.
- ② Slip the upper left cardboard core onto the blue gear of the cartridge and insert the upper roll into the cartridge holders.

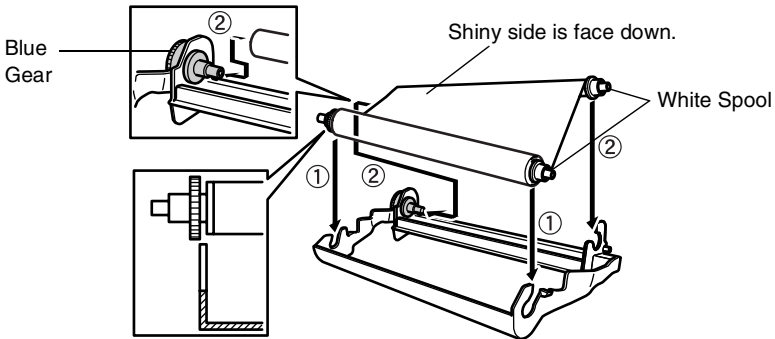

- 7 Turn the upper right white spool *clockwise* to tighten the ribbon, as shown.

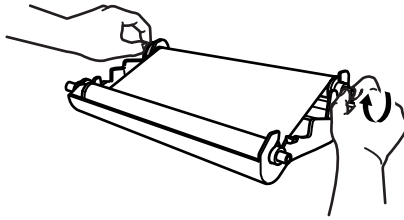

- 8 Turn the cartridge over and re-install it in your machine: Insert the recessed \triangle first and place the cartridge into its four holders.

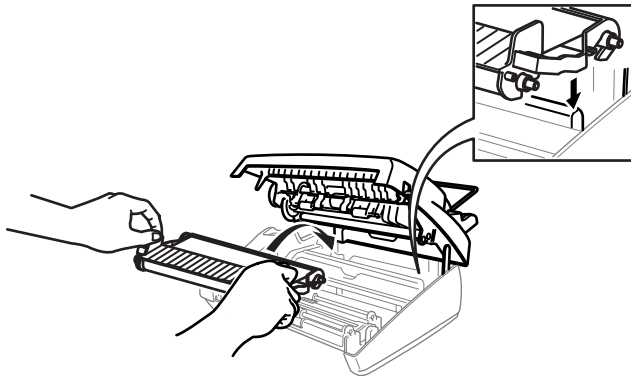
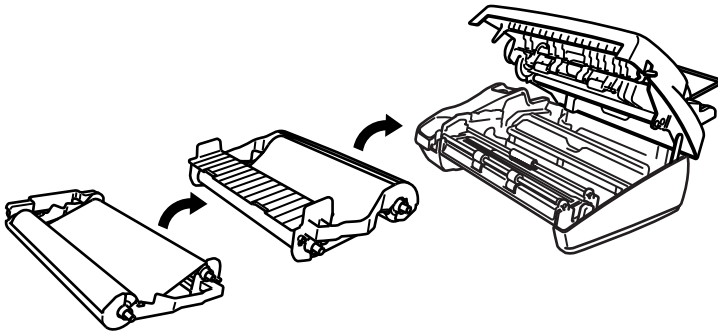

- 9 Press down on both sides of the top cover to close it securely.

Packing and shipping the Fax machine

Whenever you transport the fax machine, use the packing materials that came with the fax machine. Failure to pack the fax machine properly may damage your machine and such damages will not be covered under warranty.

- 1** Unplug the fax machine from the AC power outlet.
- 2** Remove the paper wire extension, telephone line cord, print cartridge and handset, and pack them into the carton.
- 3** Wrap the fax machine in the plastic bag and place it in the original carton with the original packing material.

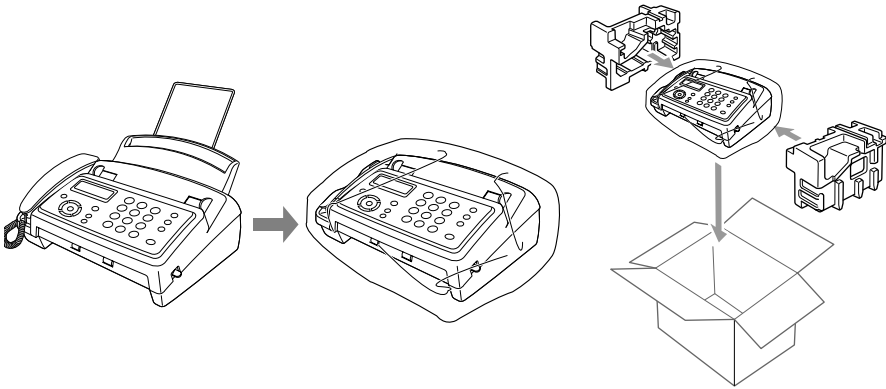

G Glossary

Automatic Document Feeder (ADF) Refers to the number of pages that can be placed in the document feeder and fed one at a time automatically.

Automatic fax transmission Sending a fax without picking up the handset or pressing **Speaker Phone**.

Auto Reduction Reduces size of incoming faxes.

Backup Print Sets the fax machine to print a copy of every fax that is received and stored in memory.

This is a safety feature so you will not lose messages during a power failure.

Beeper The sound the keys make when they are pressed, an error occurs or a document has been received or transmitted.

Broadcasting The ability to send the same fax message to more than one location.

Call Reservation Allows you send a fax and then at the end of transmission, you can talk with the other party.

Caller ID A service purchased from the Telephone Company that lets you see the number (or name) of the party calling you.

Cancel Job Cancels a programmed job, like Delayed Fax or Polling.

CNG tones The special tones (beeps) sent by fax machines during automatic transmission to tell the receiving machine that they are from a fax machine.

Communication error (or Comm. Error) An error during fax sending or receiving, usually caused by line noise or static.

Contrast Setting to compensate for dark or light documents, by lightening dark documents or darkening light documents.

Cover Page Prints a page at the other party's machine that contains the sender and recipient's name and fax number, number of pages and comment. You can generate an electronic cover page at the other end with pre-programmed information from memory or you can print a sample cover page to fax with your document.

- Delayed Fax** Sends your fax at a later time that day.
- ECM (Error Correction Mode)** Detects errors during fax transmission and resends the pages of the document that had an error.
- F/T Ring Time** The length of time that the Brother machine rings (when the receive mode setting is FAX/TEL) to notify you to pick up a voice call that it answered.
- Fax Detect** Enables the fax machine to respond to CNG tones if you interrupt a fax call by answering it.
- Fax Forwarding** Sends a fax received in memory to another preprogrammed fax number.
- Fax Receive Code** Press this code (* 5 1) when you answer a fax call from an extension or external phone.
- FAX/TEL** You can receive faxes and telephone calls. Do not use this mode if you are using a telephone answering device (TAD).
- Fax tones** The signals sent by sending and receiving fax machines while communicating information.
- Fine resolution** Resolution is 203 x 196 dpi. It is used for small print and graphs.
- LCD (liquid crystal display)** The display screen on the fax machine that shows interactive messages during On-Screen Programming and shows the date and time when the machine is idle.
- Manual fax** When you lift the handset or press **Speaker Phone** so you can hear the receiving fax machine answer before you press **Start/Copy** to begin transmission.
- Menu mode** Programming mode for changing your machine's settings.
- Next Fax Reservation** Accepts the next document in the ADF for transmission while the fax machine is still receiving.
- Out of Paper Reception** Receives faxes into the fax machine's memory when the machine is out of paper.
- Overseas Mode** Makes temporary changes to the fax tones to accommodate noise and static on overseas phone lines.

- Paging** Feature enables your fax machine to call your pager when a fax is received into its memory.
- Pause** Allows you to place a 3.5 second delay in the dialling sequence stored on Quick-Dial numbers.
- Photo resolution** A resolution setting that uses varying shades of gray for the best representation of photographs.
- Polling** The process of a fax machine calling another fax machine to retrieve waiting fax messages.
- Pulse** A form of rotary dialling on a telephone line.
- Remote Access Code** Your own four-digit code (---*) that allows you to call and access the fax machine from a remote location.
- Resolution** The number of vertical and horizontal lines per inch. See: Standard, Fine, Super Fine and Photo.
- Ring Delay** The number of rings before the fax machine answers in FAX ONLY and FAX/TEL modes.
- Search** An electronic, alphabetical listing of stored Tel-Index and Group numbers.
- Standard resolution** 203 x 98 dpi. It is used for regular size text and quickest transmission.
- Station ID** The stored information that appears on the top of faxed pages. It includes the sender's name and fax number.
- Super fine resolution** 203 x 391 dpi. Best for very small print and line art.
- Tone** A form of dialling on the telephone line used for Touch Tone telephones.
- Transmission** The process of sending documents over the phone lines from the fax machine to a receiving fax machine.

S

Specifications

General

Type	Desktop facsimile transceiver
Memory Capacity	512 KB
Paper Tray	64 g/m ² - 90 g/m ² : up to 30
Printer Type	Line Thermal with Ribbon
LCD (Liquid Crystal Display)	16 characters x 2 Lines with black lit
Operating Environment	10-35 °C
Best Print Quality	20-33 °C
Power Source	220-240V AC 50/60 Hz
Power Consumption	Standby: under 5 watts Operating: under 170 watts
Dimensions	333 (W) x 315 (D) x 332 (H) (mm)
Weight	3.6 kg

Copy

Enlarge/Reduce	50% to 150%
-----------------------	-------------

Fax

Compatibility	ITU-T Group 3
Coding System	Modified Huffman (MH)
Modem Speed	14400/12000/9600/7200/4800/2400 bps Automatic Fallback
Document Size	Width 148 mm to 216 mm Length 150 mm to 600 mm
Paper Size	A4
Automatic Document Feeder (ADF)	Up to 10 pages
Gray Scale	64 levels (Dithered)
Polling Types	Standard, Sequential, Secure, Timer
Contrast Control	Automatic/Light/Dark (manual setting)
Resolution	<ul style="list-style-type: none">• Horizontal 8 dot/mm• Vertical Standard - 3.85 line/mm Fine, Photo -7.7 line/mm Superfine, Photo (copy) - 15.4 line/mm
Tel-Index	100 stations
Automatic Redial	3 times at 5 minute intervals
Auto Answer	0, 1, 2, 3 or 4 rings (For U.K.) 2, 3 or 4 rings (For Ireland)
Speaker Type	Full Duplex. Digital
Communication Source	Public switched telephone network
Memory Transmission	Up to 20 pages *
Out of Paper Reception	Up to 25 pages *

* "Pages" refers to the ITU-T Test chart #1 (in Out of Paper Reception in ECM mode). Specifications and printed materials are subject to change without prior notice.

Index

The items in the upper case represent LCD messages.

A

- Automatic
 - automatic transmission 6-2
 - dialling 7-5
 - fax receive 5-1
 - fax redial 6-7
- Automatic Document Feeder
 - 6-3

B

- Backup Printing 8-8
- Broadcasting 6-19

C

- Call Back Message 6-15
- Call Reservation 6-14
- Caller ID 5-14–5-19
- Cancelling
 - a scheduled fax job 6-8
 - while scanning a fax 6-7
- Cleaning 12-8, 12-10
- Connecting
 - external TAD 1-10
 - external telephone 1-9
- Control panel, overview
 - 1-4, 1-5
- Copy
 - multiple 10-2
 - operations 10-1
 - reduce/enlarge 10-2
 - single 10-2
 - sort 10-2
 - specifications S-1
- Cover Page 6-9–6-11
- Custom telephone features
 - 1-15, 12-7

D

- Date and Time 4-1
- Delayed Fax 6-15
- Dialling
 - a pause 7-7
 - automatic fax redial 6-7
 - groups 6-19
 - manual 7-5

E

- ECM (Error Correction Mode)
 - 1-8
- Entering text 4-3
- Erasing Messages 8-5, 8-9
- Error messages on LCD ... 12-1
 - CHECK PAPER 12-1
 - COMM. ERROR 12-1
 - OUT OF MEMORY 12-2
- Extension Cord 11-2
- Extension telephone, using
 - 5-8
- Extension Telephones 1-13
- External telephone 1-9

F

- F/T (Fax/Tel) Outgoing
 - Announcement (OGM) 5-4
- Fax codes
 - Fax Receive Code 5-8
 - Telephone Answer Code ... 5-8
- FAX DETECT 5-5
- Fax Forward (Programming)
 - 8-12
- Fax Forwarding 8-12
- Fax Receive Code
 - 5-4, 5-8, 5-10

Fax, stand-alone	
receiving	5-1
at end of conversation ...	5-7
difficulty	12-6
polling	5-11
reducing to fit on paper ...	5-6
ring delay, setting	5-3
sending	6-3
at end of conversation ...	6-4
contrast	6-5
delayed	6-15
from memory (fax redial)	
.....	6-7
Memory Transmission ...	6-18
multiple settings	6-5
overseas	6-13
polling	6-16
redialling	7-7
resolution	6-6
specifications	S-2
Fax/Tel mode	5-1
answering at extension	
phones	5-8
double-ringing (voice calls)	
.....	5-3
Fax Detect	5-5
Fax Receive Code	5-10
receiving faxes	5-8
Setting F/T Ring Time	5-3
Setting Ring Delay	5-3
Telephone Answer Code ...	5-8
Flexible Memory Settings	8-2
Function Selection Table	
.....	3-4-3-8

G

Gray scale	S-2
------------------	-----

H

Hold	4-8, 7-6
------------	----------

I

ICM Recording Monitor	8-11
International calls	6-13
Interrupting	6-20

J

Jams	12-3
------------	------

L

LCD (Liquid Crystal Display)	
.....	1-4, 3-1
LCD Indicators	1-6

M

Maintenance, routine	12-10
Manual	
dialling	7-5
receive	5-1
transmission	6-3
Maximum Message Time ...	8-10
Melody	4-8
Memory	8-2
Memory Storage	3-1
Menu table	3-1
Message Manager Mode	8-1
Message Store	8-2
Multi-line connections (PABX)	
.....	1-15
Multiple Resolution	6-6
Mute	7-6

O

OGM (Outgoing Message)	
.....	8-4, 8-13

P

PABX	4-6
Paging	8-12
Paper	2-1
specifications	2-1

Phone line
 connections 1-11
 difficulties 12-6
 multi-line (PBX) 1-15
 Playing Messages 8-7
 Polling
 receiving 5-11
 sending 6-16
 Power 11-1–11-3, S-1
 failure 3-1
 Print
 difficulty 12-6
 Improving quality 12-8
 jams 12-3

R

Receive Mode 5-2
 FAX ONLY 5-1
 FAX/TEL 5-1
 MANUAL 5-1
 TAD:MGS MGR 5-1
 Recording a Conversation
 8-11
 Recording Monitor 8-11
 Redial/Pause 6-7
 Reducing
 long faxes 5-6
 Remote Access Code
 8-14, 8-15
 Remote Commands 8-16
 Remote Retrieval 8-14
 Reports 9-1
 Fax Journal
 Journal Period 9-3
 Transmission Verification ... 9-2
 Resolution
 fax (Standard, Fine,
 SuperFine, Photo) S-2
 setting for next fax 6-6
 Ring Delay, setting 5-3

Ring Pattern 4-8
 Ring Volume 4-5

S

Safety Instructionsii, 11-1
 Search 7-6
 Sequential Polling 5-13
 Setup
 Date and Time 4-1
 Station ID (fax header) 4-2
 Socket
 EXT. socket
 External telephone 1-9
 TAD (answering machine)
 1-10
 Speakerphone 7-6

T

TAD (Telephone Answering
 Device), external 1-10, 5-1
 connecting 1-11
 Receive Mode 5-1
 TAD MESSAGE 8-4
 Temporary Cover Page 6-10
 Text, entering 4-3
 Special Characters 4-4
 Toll Saver 8-10
 Tone signals on Pulse line ... 7-8
 Troubleshooting 12-1
 error messages on LCD ... 12-1
 if you are having difficulty
 incoming calls 12-7
 phone line difficulty 12-6
 printing or receiving faxes
 12-6
 sending faxes 12-6

V

Volume, setting
 beeper 4-5

Accessory List

Model Name	Description
PC-70	Printing Cartridge (1 set per box)
PC-71RF	1 re-fill for use in PC-70 Printing Cartridge
PC-72RF	2 re-fills for use in PC-70 Printing Cartridge
PC-74RF	4 re-fills for use in PC-70 Printing Cartridge

*For optimum print quality and product performance within published specifications, use only the correct Brother replacement ribbon.

Retrieve a Fax

Press **9 6**.

then to **Print a Memory Status List** press **1**, then enter the number of remote fax machine, and then **# #**. After the beep, hang up and wait.

Retrieve all faxes press **2**, then enter the number of remote fax machine, and then **# #**. After the beep, hang up and wait.

Erase all fax messages press **3**.

Check Receiving Status

Press **9 7**.

then for **Fax message**, press **1**.

Voice message, press **2**.

- 1 long beeps** – received messages
- 3 short beeps** – no messages

5

Change Answer Mode

Press **9 8**.

then for **TAD:MSG MGR**, press **1**.

FAX/TEL, press **2**.

FAX ONLY, press **3**.

Exit Remote Operation

Press **9 0**.

MESSAGE MANAGER REMOTE CONTROL ACCESS CARD

Using Remote Access Code

- 1** Dial your fax machine phone number from a touch tone phone.
- 2** Enter your Remote Control Access Code (3 digits followed by *) after the beep.
- 3** The fax machine signals the kinds of messages received:
 - 1 long beep** – Fax message(s)
 - 2 long beeps** – Voice message(s)
 - 3 long beeps** – Fax and Voice message(s)
 - No beeps** – no messages
- 4** After 2 short beeps, enter a command.
- 5** Press **9 0** to reset the machine when you finish.
- 6** Hang up.

6

1

Changing Remote Access Code

- 1 Press **Menu/Set**, **8**, **7**.
- 2 Enter a three-digit code using number keys 0-9. The * cannot be changed.
- 3 Press **Menu/Set**.
- 4 Press **Stop**.

Remote Commands

Listen to Voice Messages

Press **9 1**.

then to **Repeat a message** press **1**.

Skip to next message, press **2**.

Stop playing the message press **9**.

2

Erase All Voice Messages

Press **9 3**. If you hear three beeps, all messages have not yet been heard, and the messages will not be erased.

Play/Record Outgoing Message

Press **9 4**.

then to **Play TAD MESSAGE OGM** press **1 1**.

Play F/T MESSAGE press **1 2**.

Play PAGING MSG press **1 3**.

Record new TAD MESSAGE

press **2 1**, then speak after beep.

press **9** to stop.

Record new F/T MESSAGE press **2 2**,

then speak after beep. press **9** to stop.

Record new PAGING MSG press **2 3**.

then speak after beep. press **9** to stop.

3

Change Paging/Fax Forwarding Setting

Press **9 5**.

then to **Turn feature off** press **1**.

Enter Fax Forwarding press **2**.

Enter Paging press **3**.

Program Fax Forward Number

press **4**. Enter the new number of

the remote fax machine where

you want your fax messages

forwarded, and then press **# #**.

Press **9 6 1** after two short beeps,

then enter the number of remote

fax machine, and then **# #** to

retrieve Memory Status List.

4



This machine is approved for use in the country of purchase only, local Brother companies or their dealers will only support fax machines purchased in their own countries.

UK/IRE
Version A

Free Manuals Download Website

<http://myh66.com>

<http://usermanuals.us>

<http://www.somanuals.com>

<http://www.4manuals.cc>

<http://www.manual-lib.com>

<http://www.404manual.com>

<http://www.luxmanual.com>

<http://aubethermostatmanual.com>

Golf course search by state

<http://golfingnear.com>

Email search by domain

<http://emailbydomain.com>

Auto manuals search

<http://auto.somanuals.com>

TV manuals search

<http://tv.somanuals.com>