

6E122-26, 6E132-25, 6E123-26 and 6E133-25 SmartSwitch 6000 Interface Modules User's Guide

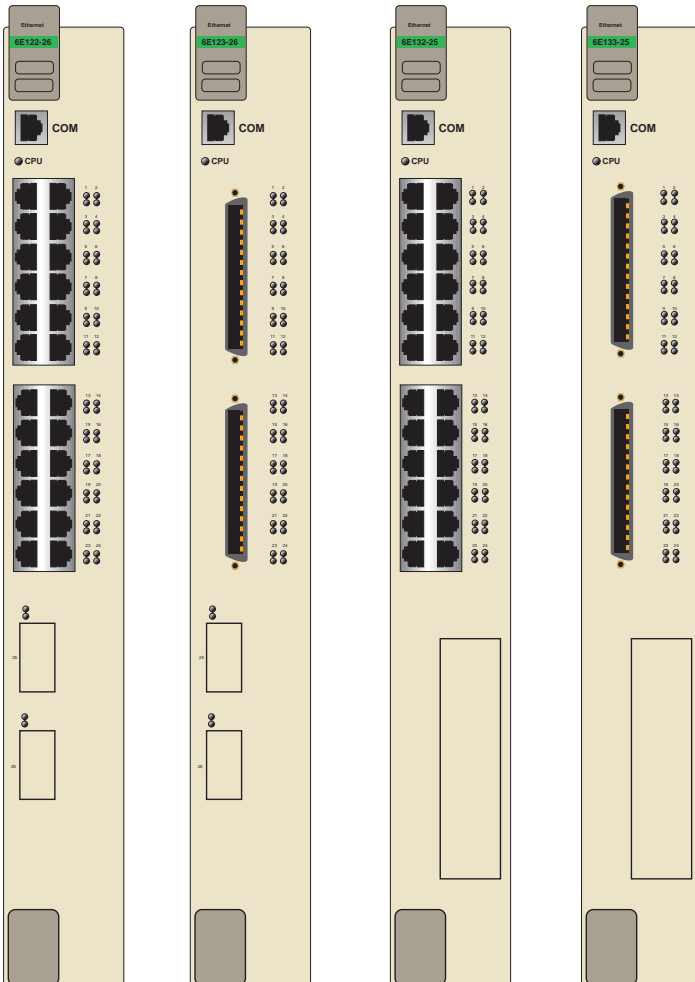

NOTICE

Cabletron Systems reserves the right to make changes in specifications and other information contained in this document without prior notice. The reader should in all cases consult Cabletron Systems to determine whether any such changes have been made.

The hardware, firmware, or software described in this manual is subject to change without notice.

IN NO EVENT SHALL CABLETRON SYSTEMS BE LIABLE FOR ANY INCIDENTAL, INDIRECT, SPECIAL, OR CONSEQUENTIAL DAMAGES WHATSOEVER (INCLUDING BUT NOT LIMITED TO LOST PROFITS) ARISING OUT OF OR RELATED TO THIS MANUAL OR THE INFORMATION CONTAINED IN IT, EVEN IF CABLETRON SYSTEMS HAS BEEN ADVISED OF, KNOWN, OR SHOULD HAVE KNOWN, THE POSSIBILITY OF SUCH DAMAGES.

© 1998 by Cabletron Systems, Inc., P.O. Box 5005, Rochester, NH 03866-5005

All Rights Reserved

Printed in the United States of America

Order Number: 9032076-05 August 1998

Cabletron Systems is a registered trademark and **SmartSwitch** is a trademark of Cabletron Systems, Inc.

All other product names mentioned in this manual may be trademarks or registered trademarks of their respective companies.

FCC NOTICE

This device complies with Part 15 of the FCC rules. Operation is subject to the following two conditions: (1) this device may not cause harmful interference, and (2) this device must accept any interference received, including interference that may cause undesired operation.

NOTE: This equipment has been tested and found to comply with the limits for a Class A digital device, pursuant to Part 15 of the FCC rules. These limits are designed to provide reasonable protection against harmful interference when the equipment is operated in a commercial environment. This equipment uses, generates, and can radiate radio frequency energy and if not installed in accordance with the operator's manual, may cause harmful interference to radio communications. Operation of this equipment in a residential area is likely to cause interference in which case the user will be required to correct the interference at his own expense.

WARNING: Changes or modifications made to this device which are not expressly approved by the party responsible for compliance could void the user's authority to operate the equipment.

Printed on



Recycled Paper

INDUSTRY CANADA NOTICE

This digital apparatus does not exceed the Class A limits for radio noise emissions from digital apparatus set out in the Radio Interference Regulations of the Canadian Department of Communications.

Le présent appareil numérique n'émet pas de bruits radioélectriques dépassant les limites applicables aux appareils numériques de la class A prescrites dans le Règlement sur le brouillage radioélectrique édicté par le ministère des Communications du Canada.

VCCI NOTICE

This is a Class A product based on the standard of the Voluntary Control Council for Interference by Information Technology Equipment (VCCI). If this equipment is used in a domestic environment, radio disturbance may arise. When such trouble occurs, the user may be required to take corrective actions.

この装置は、情報処理装置等電波障害自主規制協議会（VCCI）の基準に基づくクラスA情報技術装置です。この装置を家庭環境で使用すると電波妨害を引き起こすことがあります。この場合には使用者が適切な対策を講ずるよう要求されることがあります。

CABLETRON SYSTEMS, INC. PROGRAM LICENSE AGREEMENT

IMPORTANT: Before utilizing this product, carefully read this License Agreement.

This document is an agreement between you, the end user, and Cabletron Systems, Inc. ("Cabletron") that sets forth your rights and obligations with respect to the Cabletron software program (the "Program") contained in this package. The Program may be contained in firmware, chips or other media. BY UTILIZING THE ENCLOSED PRODUCT, YOU ARE AGREEING TO BECOME BOUND BY THE TERMS OF THIS AGREEMENT, WHICH INCLUDES THE LICENSE AND THE LIMITATION OF WARRANTY AND DISCLAIMER OF LIABILITY. IF YOU DO NOT AGREE TO THE TERMS OF THIS AGREEMENT, PROMPTLY RETURN THE UNUSED PRODUCT TO THE PLACE OF PURCHASE FOR A FULL REFUND.

CABLETRON SOFTWARE PROGRAM LICENSE

1. **LICENSE.** You have the right to use only the one (1) copy of the Program provided in this package subject to the terms and conditions of this License Agreement.

You may not copy, reproduce or transmit any part of the Program except as permitted by the Copyright Act of the United States or as authorized in writing by Cabletron.
2. **OTHER RESTRICTIONS.** You may not reverse engineer, decompile, or disassemble the Program.
3. **APPLICABLE LAW.** This License Agreement shall be interpreted and governed under the laws and in the state and federal courts of New Hampshire. You accept the personal jurisdiction and venue of the New Hampshire courts.

EXCLUSION OF WARRANTY AND DISCLAIMER OF LIABILITY

1. **EXCLUSION OF WARRANTY.** Except as may be specifically provided by Cabletron in writing, Cabletron makes no warranty, expressed or implied, concerning the Program (including its documentation and media).

CABLETRON DISCLAIMS ALL WARRANTIES, OTHER THAN THOSE SUPPLIED TO YOU BY CABLETRON IN WRITING, EITHER EXPRESSED OR IMPLIED, INCLUDING BUT NOT LIMITED TO IMPLIED WARRANTIES OF MERCHANTABILITY AND FITNESS FOR A PARTICULAR PURPOSE, WITH RESPECT TO THE PROGRAM, THE ACCOMPANYING WRITTEN MATERIALS, AND ANY ACCOMPANYING HARDWARE.

2. **NO LIABILITY FOR CONSEQUENTIAL DAMAGES.** IN NO EVENT SHALL CABLETRON OR ITS SUPPLIERS BE LIABLE FOR ANY DAMAGES WHATSOEVER (INCLUDING, WITHOUT LIMITATION, DAMAGES FOR LOSS OF BUSINESS, PROFITS, BUSINESS INTERRUPTION, LOSS OF BUSINESS INFORMATION, SPECIAL, INCIDENTAL, CONSEQUENTIAL, OR RELIANCE DAMAGES, OR OTHER LOSS) ARISING OUT OF THE USE OR INABILITY TO USE THIS CABLETRON PRODUCT, EVEN IF CABLETRON HAS BEEN ADVISED OF THE POSSIBILITY OF SUCH DAMAGES. BECAUSE SOME STATES DO NOT ALLOW THE EXCLUSION OR LIMITATION OF LIABILITY FOR CONSEQUENTIAL OR INCIDENTAL DAMAGES, OR ON THE DURATION OR LIMITATION OF IMPLIED WARRANTIES, IN SOME INSTANCES THE ABOVE LIMITATIONS AND EXCLUSIONS MAY NOT APPLY TO YOU.

UNITED STATES GOVERNMENT RESTRICTED RIGHTS

The enclosed product (a) was developed solely at private expense; (b) contains “restricted computer software” submitted with restricted rights in accordance with Section 52227-19 (a) through (d) of the Commercial Computer Software - Restricted Rights Clause and its successors, and (c) in all respects is proprietary data belonging to Cabletron and/or its suppliers.

For Department of Defense units, the product is licensed with “Restricted Rights” as defined in the DoD Supplement to the Federal Acquisition Regulations, Section 52.227-7013 (c) (1) (ii) and its successors, and use, duplication, disclosure by the Government is subject to restrictions as set forth in subparagraph (c) (1) (ii) of the Rights in Technical Data and Computer Software clause at 252.227-7013. Cabletron Systems, Inc., 35 Industrial Way, Rochester, New Hampshire 03867-0505.

DECLARATION OF CONFORMITY

Application of Council Directive(s): **89/336/EEC
73/23/EEC**

Manufacturer's Name: **Cabletron Systems, Inc.**

Manufacturer's Address: **35 Industrial Way
PO Box 5005
Rochester, NH 03867**

European Representative Name: **Mr. J. Solari**

European Representative Address: **Cabletron Systems Limited
Nexus House, Newbury Business Park
London Road, Newbury
Berkshire RG13 2PZ, England**

Conformance to Directive(s)/Product Standards: **EC Directive 89/336/EEC
EC Directive 73/23/EEC
EN 55022
EN 50082-1
EN 60950**

Equipment Type/Environment: **Networking Equipment, for use in a
Commercial or Light Industrial
Environment.**

We the undersigned, hereby declare, under our sole responsibility, that the equipment packaged with this notice conforms to the above directives.

Manufacturer

Mr. Ronald Fotino

Full Name

Principal Compliance Engineer

Title

Rochester, NH, USA

Location

Legal Representative in Europe

Mr. J. Solari

Full Name

Managing Director - E.M.E.A.

Title

Newbury, Berkshire, England

Location

CONTENTS

CHAPTER 1 INTRODUCTION

1.1	Using This Guide	1-1
1.2	Structure of This Guide.....	1-1
1.3	6E12X-26 and 6E13X-25 Overview.....	1-2
1.3.1	Connectivity	1-4
1.3.2	Full Duplex Switched Ethernet.....	1-4
1.3.3	SmartTrunk	1-5
1.3.4	Management.....	1-5
1.3.5	Switching Options	1-5
1.3.6	Standards Compatibility.....	1-6
1.3.7	LANVIEW Diagnostic LEDs	1-6
1.3.8	Year 2000 Compliant	1-6
1.3.9	Runtime IP Address Discovery	1-6
1.3.10	Local Management Features	1-7
1.4	Optional Features	1-8
1.5	Document Conventions	1-9
1.6	Getting Help.....	1-10
1.7	Related Manuals.....	1-11

CHAPTER 2 NETWORK REQUIREMENTS

2.1	SmartTrunk.....	2-1
2.2	10BASE-T Network	2-2
2.3	100BASE-TX Network	2-2
2.4	100BASE-FX Fiber Optic Network	2-2

CHAPTER 3 INSTALLATION

3.1	Required Tools	3-1
3.2	Unpacking the 6E12X-26 and 6E13X-25.....	3-1
3.3	6E12X-26 and 6E13X-25 Options	3-2
3.4	Installing the 6E12X-26 and 6E13X-25 Into the 6C105 Chassis	3-2

Contents

3.5	Connecting to the Network.....	3-5
3.5.1	Connecting UTP Cables to Ports 1 Through 24 of the 6E122-26 and 6E132-25	3-6
3.5.2	Connecting UTP Cables to Ports 1 Through 24 of the 6E133-25 and 6E123-26	3-8
3.5.3	Connecting a Twisted Pair Segment to the FE-100TX	3-10
3.5.4	Connecting a Fiber Optic Segment to the FE-100FX and FE-100F3	3-12
3.6	Completing the Installation.....	3-14

CHAPTER 4 TROUBLESHOOTING

4.1	Using LANVIEW.....	4-1
4.2	FE-100TX LED.....	4-4
4.3	Troubleshooting Checklist.....	4-6
4.4	Using the RESET Button	4-7

CHAPTER 5 LOCAL MANAGEMENT

5.1	Overview	5-1
5.2	Local Management Keyboard Conventions	5-2
5.3	Management Terminal Setup.....	5-3
5.3.1	Console Cable Connection.....	5-3
5.3.2	Connecting an Uninterruptible Power Supply (UPS).....	5-4
5.3.3	Management Terminal Setup Parameters	5-5
5.3.4	Telnet Connections	5-6
5.4	Accessing Local Management	5-7
5.4.1	Navigating Local Management Screens.....	5-8
5.4.2	Selecting Local Management Menu Screen Items.....	5-10
5.4.3	Exiting Local Management Screens	5-10
5.5	The Main Menu Screen.....	5-12
5.6	Chassis Menu Screen.....	5-13
5.7	Chassis Configuration Screen	5-15
5.7.1	Setting the IP Address.....	5-17
5.7.2	Setting the Subnet Mask	5-18
5.7.3	Setting the Chassis Date.....	5-19
5.7.4	Setting the Chassis Time	5-19
5.7.5	Entering a New Screen Refresh Time.....	5-20
5.7.6	Setting the Screen Lockout Time	5-21
5.7.7	Setting the Operational Mode.....	5-22
5.8	SNMP Community Names Screen.....	5-24
5.8.1	Establishing Community Names	5-25
5.9	SNMP Traps Screen	5-27
5.9.1	Configuring the Trap Table.....	5-28

5.10	Chassis Environmental Screen	5-29
5.11	Port Redirect Function Screen	5-30
5.11.1	Displaying the Source and Destination Entries.....	5-32
5.11.2	Changing Source and Destination Ports.....	5-33
5.12	Module Selection Screen.....	5-34
5.12.1	Selecting a Module	5-35
5.13	Module Menu Screen	5-36
5.14	Module Configuration Menu Screen	5-38
5.15	General Configuration Screen	5-41
5.15.1	Setting the IP Address	5-45
5.15.2	Setting the Subnet Mask.....	5-46
5.15.3	Setting the Default Gateway	5-47
5.15.4	Setting the TFTP Gateway IP Address	5-48
5.15.5	Setting the Module Date	5-48
5.15.6	Setting the Module Time	5-49
5.15.7	Entering a New Screen Refresh Time	5-50
5.15.8	Setting the Screen Lockout Time.....	5-50
5.15.9	Setting the Operational Mode	5-51
5.15.10	Setting the Management Mode.....	5-52
5.15.11	Configuring the COM Port	5-53
5.15.12	Changing the Com Port Application.....	5-55
5.15.13	Clearing NVRAM	5-56
5.15.14	Enabling/Disabling IP Fragmentation	5-57
5.16	SNMP Community Names Screen	5-57
5.16.1	Establishing Community Names.....	5-59
5.17	SNMP Traps Screen.....	5-60
5.17.1	Configuring the Trap Table	5-61
5.18	Switch Configuration Screen	5-62
5.18.1	Setting the STA.....	5-64
5.18.2	Setting the Age Time	5-65
5.18.3	Setting (Enabling or Disabling) the Port Status	5-65
5.19	Ethernet Full Duplex Configuration Screen	5-66
5.19.1	Setting the Operation Mode.....	5-68
5.20	Module Specific Configuration Menu Screen	5-69
5.21	System Resources Screen	5-72
5.21.1	Setting the Reset Peak Utilization	5-73

Contents

5.22	High Speed Interface Configuration Menu Screen (6E12X-26 Only)	5-74
5.22.1	Configuring an FE-100FX or FE-100F3 in Port 25 or 26.....	5-77
5.22.2	Setting the FE-100FX and FE-100F3 Operational Mode.....	5-77
5.22.3	Configuring an FE-100TX in Port 25 or 26	5-78
5.22.4	Setting the FE-100TX Operational Mode	5-78
5.22.5	Setting the FE-100TX Advertised Ability	5-78
5.23	Flash Download Screen.....	5-79
5.23.1	Image File Download Using TFTP	5-82
5.23.2	Image File Download Using RUNTIME	5-83
5.23.3	Image File Download Using BootP.....	5-84
5.24	Port Redirect Function Screen.....	5-85
5.24.1	Displaying the Source and Destination Entries	5-87
5.24.2	Changing Source and Destination Ports	5-87
5.25	Broadcast Suppression Screen	5-89
5.25.1	Setting the Threshold	5-90
5.25.2	Setting the Reset Peak Switch	5-91
5.26	Module Statistics Menu Screen	5-91
5.27	Switch Statistics Screen.....	5-93
5.27.1	Using the Clear Counters Command	5-94
5.28	The Interface Statistics Screen	5-95
5.28.1	Displaying Interface Statistics	5-98
5.28.2	Using the Clear Counters Command	5-99
5.29	RMON Statistics Screen	5-99
5.29.1	Displaying RMON Statistics	5-103
5.29.2	Using the Clear Counters Command	5-103
5.30	Network Tools	5-104
5.30.1	Built-in Commands	5-105
5.30.2	Special Commands	5-115

APPENDIX A SPECIFICATIONS

A.1	Device Specifications.....	A-1
A.2	Physical Properties	A-1
A.3	Environmental Requirements.....	A-1
A.4	Input/Output Ports.....	A-2
A.5	COM Port Pinout Assignments	A-3
A.6	Regulatory Compliance.....	A-3

CHAPTER 1

INTRODUCTION

Welcome to the Cabletron Systems **6E122-26, 6E132-25, 6E123-26 and 6E133-25 SmartSwitch 6000 Interface Modules User's Guide**. This guide describes the 6E122-26, 6E132-25, 6E123-26 and 6E133-25 Interface Modules and provides information concerning network requirements, installation, troubleshooting, and the use of Local Management.

1.1 USING THIS GUIDE

Read through this guide completely to understand the interface module features, capabilities, and Local Management functions. A general working knowledge of Ethernet and IEEE 802.3 type data communications networks and their physical layer components is helpful when using these devices.



Unless noted differently, the information in this guide applies to all four SmartSwitch 6000 interface modules, which are referred to as either the "6E12X-26 and 6E13X-25" or the "module(s)".

1.2 STRUCTURE OF THIS GUIDE

This guide is organized as follows:

Chapter 1, Introduction, outlines the contents of this manual, describes the features of the 6E12X-26 and 6E13X-25, provides instructions on obtaining additional help and concludes with a list of related manuals.

Chapter 2, Network Requirements, explains the network requirements to consider before installing the 6E12X-26 and 6E13X-25 into the 6C105 SmartSwitch 6000 chassis.

Chapter 3, Installation, provides instructions on how to install the modules in the chassis and connect cables to the modules.

Chapter 4, Troubleshooting, details the 6E12X-26 and 6E13X-25 LANVIEW LEDs that enable you to quickly diagnose network/operational problems.

Chapter 5, Local Management, describes how to access Local Management and use the Local Management screens to manage the 6E12X-26 and 6E13X-25 interface modules and the 6C105 chassis.

Appendix A, Specifications, contains information on functionality and operating specifications, connector pinouts, environmental requirements, and physical properties.

Appendix B, FE-100TX, FE-100FX and FE-100F3 Specifications, contains information about FE-100TX pinouts and information concerning cable types used with the FE-100FX and FE100-F3.

Appendix C, Mode Switch Bank Settings and Optional Installations, describes how to install optional Fast Ethernet Interface Modules and how to set the Mode Switches.

1.3 6E12X-26 AND 6E13X-25 OVERVIEW

The 6E12X-26 and 6E13X-25, shown in **Figure 1-1**, are interface modules for Cabletron Systems 6C105 SmartSwitch 6000 chassis.

The 6E12X-26 and 6E13X-25 are high-speed network switch devices that support 802.1D switching (bridging), 802.1Q switching, and Cabletron Systems SecureFast Switching Virtual Network technology. Ports 25 and 26 of the 6E12X-26 support optional Fast Ethernet Interface Modules and can provide uplinks to 100BASE-TX or 100BASE-FX Fast Ethernet networks. The 6E13X-25 is capable of being equipped with a High Speed Interface Module (HSIM) that provides for additional connectivity to other high speed networking technologies such as Asynchronous Transfer Mode (ATM), Wide Area Networks (WANs) and Fiber Distributed Data Interface (FDDI).

The 6E12X-26 and 6E13X-25 can be used to connect individual high-bandwidth user devices, such as workstations, and to provide a central switching point for multiple Ethernet segments using devices such as Cabletron Systems HubSTACK or other third party stackable devices.



Figure 1-1 displays the 6E122-26 and 6E132-25. The 6E122-26 and the 6E123-26 are functionally identical, as are the 6E132-25 and the 6E133-25. The only difference being that the 6E123-26 and 6E133-25 modules support RJ21 front panel connections.

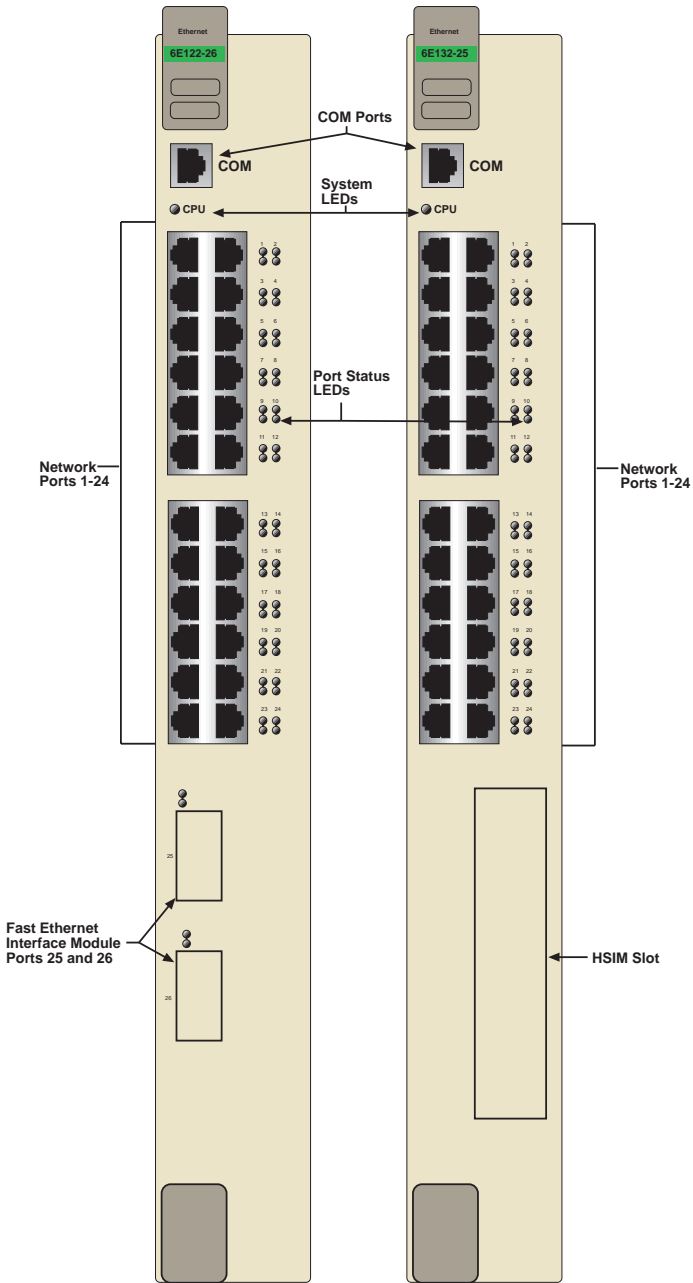

207601

Figure 1-1 The 6E122-26 and 6E132-25

1.3.1 Connectivity

The 6E122-26 and 6E132-25 connect to Ethernet networks or workstations through 24 RJ45 ports on the front panel. These ports support UTP connections up to 100 meters. The ports are IEEE 802.3 10BASE-T compliant.

The 6E123-26 and 6E133-25 connect to Ethernet networks or workstations through two RJ21 connectors on the front panel. These connectors support 25 pair cable at lengths up to 100 meters. The ports are IEEE 802.3 10BASE-T compliant.

The 6E12X-26 modules have two front panel slots (ports 25 and 26) for optional Fast Ethernet Interface Modules to support an uplink to 100 Mbps Ethernet backbones or a high speed connection to a local server.

The 6E13X-25 modules have one front panel slot for an optional High Speed Interface Module to provide for additional connectivity to other high speed networking technologies such as ATM, WANs and FDDI.

1.3.2 Full Duplex Switched Ethernet

Each switched Ethernet port supports full wire-speed Ethernet communications and can be configured to operate in Full Duplex Switched Ethernet mode, which provides up to 20 Mbps of bandwidth.

The optional Fast Ethernet Interface Modules for the 6E12X-26 can also be configured to operate in Full Duplex Switched Ethernet mode, which provides up to 200 Mbps of bandwidth.

1.3.3 SmartTrunk

SmartTrunk, also referred to as SmartTrunking, is Cabletron Systems' terminology for load balancing or load sharing. SmartTrunk technology provides an easy-to-implement mechanism to group, or aggregate, multiple links of any technology together to scale the backbone bandwidth beyond the limitations of a single link. All links are user-configurable so administrators can scale the backbone bandwidth by adding SmartTrunk links. The SmartTrunk benefits are as follows:

- All purchased bandwidth is used.
- Distributed, resilient links increase reliability and performance.
- Multiple technologies are supported within a single trunk for maximum flexibility.

For more information about SmartTrunk, refer to the Cabletron Systems *SmartTrunk User's Guide*.

1.3.4 Management

Management of the 6E12X-26 and 6E13X-25 is accomplished using Local Management tools or remote SNMP management stations. Local Management is accessible through the RS232 COM port on the front panel using a local VT100 terminal, or a remote VT100 terminal via a modem connection, and in-band via a Telnet connection. In-band remote management is possible through any SNMP compliant Network Management Software.

1.3.5 Switching Options

The 6E12X-26 and 6E13X-25 provide 802.1D switching, 802.1Q switching, or SecureFast Switching Virtual Network Services between all of the front panel interfaces including Fast Ethernet Interface Modules and High Speed Interface Modules (HSIMs).

SecureFast switching and 802.1Q switching allow for future migration to Virtual Network technologies without requiring the replacement of existing equipment.

1.3.6 Standards Compatibility

The 6E12X-26 and 6E13X-25 are fully compliant with the IEEE 802.3 standard. The optional Fast Ethernet Interface Modules are fully compliant with the IEEE 802.3u standard. The 6E12X-26 and 6E13X-25 provide IEEE 802.1D Spanning Tree Algorithm (STA) support to enhance the overall reliability of the network and protect against “loop” conditions. The 6E12X-26 and 6E13X-25 support a wide variety of industry standard MIBs including RFC 1213 (MIB II), RFC 1757 (RMON), RFC 1493 (Bridge MIB) and RFC 1354 (FIB MIB). A full suite of Cabletron Systems Enterprise MIBs provide a wide array of statistical information to enhance troubleshooting.

1.3.7 LANVIEW Diagnostic LEDs

LANVIEW diagnostic LEDs serve as an important troubleshooting aid by providing an easy way to observe the status of individual ports and overall network operations. [Chapter 4](#) provides details about the 6E12X-26 and 6E13X-25 LANVIEW LEDs.

1.3.8 Year 2000 Compliant

The 6E12X-26 and 6E13X-25 have an internal clock that can maintain the current time and date beyond the year 1999.

1.3.9 Runtime IP Address Discovery

This feature enables the modules to automatically accept an IP address from a BootP server on the network into NVRAM without requiring a user to enter an IP address through Local Management.

When the modules are connected to the network and powered up, Runtime IP Address Discovery (RAD) checks the modules for an IP address. If one has not yet been assigned (module and 6C105 chassis IP address set to 0.0.0.0), RAD checks to see if any of the module interfaces have a link. If so, RAD sends out Reverse Address Resolution Protocol (RARP) and BootP requests to obtain an IP address from a RARP or BootP server on the network.

The RAD requests start out at an interval of one second. The interval then doubles after every transmission until an interval of 300 seconds is reached. At this point, the interval remains at 300 seconds. The RAD requests continue until an IP address is received from a RARP or BootP server, or an IP address is entered using Local Management.

1.3.10 Local Management Features

Local Management provides the tools that allow management of the 6E12X-26 and 6E13X-25, the Fast Ethernet Interface Modules, the High Speed Interface Module (HSIM) and the 6C105 chassis. It also allows the following tasks to be performed:

- Manage any module installed in the 6C105 via a single terminal connection.
- Assign an IP address and subnet mask to the 6C105 chassis, 6E12X-26 and 6E13X-25.
- Select a default gateway.
- Control local and remote access.
- Designate workstations to receive SNMP traps from the 6E12X-26 and 6E13X-25 interface modules and the 6C105 chassis.
- Configure module specific SNMP MIB objects including the IETF Bridge MIB objects.

Chapter 5 provides detailed information about Local Management of the 6E12X-26 and 6E13X-25, the optional Fast Ethernet Interface Modules and the 6C105 chassis. The associated High Speed Interface Module user's guide provides detailed information about Local Management of the applicable HSIM.

1.4 OPTIONAL FEATURES

Options for the 6E12X-26 and 6E13X-25 are Fast Ethernet Interface Modules and High Speed Interface Modules, which add remote uplink capability.

Cabletron Systems provides Fast Ethernet Interface Modules for the 6E12X-26 to support uplinks to 100 Mbps Ethernet backbones or high speed connections to local servers. The Fast Ethernet Interface Modules are listed in [Table 1-1](#).

Table 1-1 Fast Ethernet Interface Modules

P/N	Description	Application
FE-100TX	Uses RJ45 connector	Supports Category 5 Unshielded Twisted Pair (UTP) cabling with an impedance between 85 and 111 ohms.
FE-100FX	Uses SC connector	Supports multimode fiber optic cabling.
FE-100F3	Uses SC connector	Supports single mode fiber optic cabling.

Cabletron Systems provides High Speed Interface Modules for the 6E13X-25 to provide for additional connectivity to other high speed networking technologies such as ATM, WANs and FDDI. The HSIMs available for the 6E13X-25 are listed in the Release Notes.

1.5 DOCUMENT CONVENTIONS

The following conventions are used throughout this document:

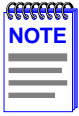

Note symbol. Calls the reader's attention to any item of information that may be of special importance.



Tip symbol. Conveys helpful hints concerning procedures or actions.



Caution symbol. Contains information essential to avoid damage to the equipment.



Electrical Hazard Warning symbol. Warns against an action that could result in personal injury or death due to an electrical hazard.

1.6 GETTING HELP

For additional support related to this device or document, contact the Cabletron Systems Global Call Center:

World Wide Web	http://www.cabletron.com/ For technical support, select <i>Service and Support</i>
Phone	(603) 332-9400
Internet mail	support@cabletron.com
FTP Login Password	ftp://ftp.cabletron.com <i>anonymous</i> <i>your email address</i>
To send comments or suggestions concerning this document, contact the Cabletron Systems Technical Writing Department via the following email address: TechWriting@cabletron.com <i>Make sure to include the document Part Number in the email message.</i>	

Before calling the Cabletron Systems Global Call Center, have the following information ready:

- Your Cabletron Systems service contract number
- A description of the failure
- A description of any action(s) already taken to resolve the problem (e.g., changing mode switches, rebooting the unit, etc.)
- The serial and revision numbers of all involved Cabletron Systems products in the network
- A description of your network environment (layout, cable type, etc.)
- Network load and frame size at the time of trouble (if known)
- The device history (i.e., have you returned the device before, is this a recurring problem, etc.)
- Any previous Return Material Authorization (RMA) numbers

1.7 RELATED MANUALS

The following manuals may help to set up, control, and manage the 6E12X-26 and 6E13X-25:

Cabletron Systems *HSIM-A6DP User's Guide*

Cabletron Systems *HSIM-F6 User's Guide*

Cabletron Systems *HSIM-FE6 User's Guide*

Cabletron Systems *HSIM-W6 User's Guide*

Cabletron Systems *HSIM-W84 User's Guide*

Cabletron Systems *HSIM-W87 User's Guide*

Cabletron Systems *HSIM-G01/G09 User's Guide*

Cabletron Systems *Ethernet Technology Guide*

Cabletron Systems *Cabling Guide*

Cabletron Systems *Port Based VLAN User's Guide*

Cabletron Systems *SmartTrunk User's Guide*

These manuals can be obtained from the World Wide Web in Adobe Acrobat Portable Document Format (PDF) at the following site:

<http://www.cabletron.com/>



All documentation for the Cabletron Systems SecureFast VLAN Manager software is contained on the VLAN Manager CD-ROM.

CHAPTER 2

NETWORK REQUIREMENTS

Before installing the 6E12X-26 and 6E13X-25 or Fast Ethernet Interface Modules (FE-100TX, FE-100FX, or FE-100F3), review the requirements and specifications referred to in this chapter concerning the following:

- SmartTrunk (Section 2.1)
- 10BASE-T Twisted Pair Network (Section 2.2)
- 100BASE-TX Twisted Pair Network (Section 2.3)
- 100BASE-FX Fiber Optic Network (Section 2.4)

The network installation must meet the guidelines to ensure satisfactory performance of this equipment. Failure to follow the guidelines may produce poor network performance.



The Cabletron Systems *Cabling Guide* and *SmartTrunk User's Guide*, referred to in the following sections, can be found on the Cabletron Systems World Wide Web site: <http://www.cabletron.com/>

2.1 SmartTrunk

To connect the 6E12X-26 and 6E13X-25 to a network so it can take advantage of the SmartTrunk feature, there are certain rules concerning port connections and configurations that must be followed for proper operation. Refer to the Cabletron Systems *SmartTrunk User's Guide* for additional information.

2.2 10BASE-T NETWORK

When connecting a 10BASE-T segment to any of the 6E12X-26 and 6E13X-25 ports (Interfaces 1 through 24), ensure that the network meets the Ethernet network requirements of the IEEE 802.3 standard for 10BASE-T. Refer to the Cabletron Systems *Cabling Guide* for details.

2.3 100BASE-TX NETWORK

The 6E12X-26, with an FE-100TX installed in ports 25 and 26, provides an RJ45 connection that supports Category 5 UTP cabling with an impedance between 85 and 111 ohms. The device at the other end of the twisted pair segment must meet IEEE 802.3u 100BASE-TX Fast Ethernet network requirements for the devices to operate at 100 Mbps. Refer to the Cabletron Systems *Cabling Guide* for details.

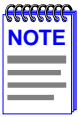

The 6E12X-26 with an FE-100TX installed is capable of operating at either 10 or 100 Mbps. The FE-100TX can automatically sense the speed of the other device and adjusts its speed accordingly.

2.4 100BASE-FX FIBER OPTIC NETWORK

Ports 25 and 26 of the 6E12X-26 support the Cabletron Systems FE-100FX and FE-100F3 fiber optic interface modules. The device at the other end of the fiber optic segment must meet the 100BASE-FX Fast Ethernet network requirements to operate at 100 Mbps. Refer to the Cabletron Systems *Cabling Guide* for details.

Multimode Mode Fiber Optic Cable Length

The maximum multimode fiber optic cable length of a 100BASE-FX segment is covered in the Cabletron Systems *Cabling Guide*.

Single Mode Fiber Cable Lengths

The maximum single mode fiber optic length of a 100BASE-FX segment may be no more than 5 km between Data Terminal Equipment (DTE to DTE) in half duplex mode or 20 km (DTE to DTE) in full duplex mode.

CHAPTER 3

INSTALLATION



Only qualified personnel should install the 6E12X-26 and 6E13X-25.

This chapter covers the following items:

- Required tools
- Unpacking the 6E12X-26 and 6E13X-25
- Installing the 6E12X-26 and 6E13X-25 into the 6C105 chassis
- Connecting to the network

3.1 REQUIRED TOOLS

A Phillips screwdriver is required to install the optional Fast Ethernet Interface Modules into the 6E12X-26.

3.2 UNPACKING THE 6E12X-26 AND 6E13X-25

1. Open the box and remove the packing material protecting the module.
2. Verify the contents of the carton as listed in [Table 3-1](#).

Table 3-1 Contents of Shipping Carton

Item	Quantity
6E132-25, 6E122-26, 6E133-25 or 6E123-26	1
Release Notes	1
RJ21 Angle Adapter (6E123-26 and 6E133-25 only)	2

3.3 6E12X-26 AND 6E13X-25 OPTIONS

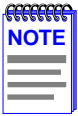

Install any optional equipment before proceeding to Section 3.4.

If the 6E12X-26 is to be installed with an optional Fast Ethernet Interface Module, refer to [Appendix C](#) for installation instructions. The installation instructions for the HSIMs available for the 6E13X-25 are located in the associated user's guide.

3.4 INSTALLING THE 6E12X-26 AND 6E13X-25 INTO THE 6C105 CHASSIS



Failure to observe static safety precautions could cause damage to the 6E12X-26 and 6E13X-25. Follow static safety handling rules and properly wear the antistatic wrist strap provided with the 6C105 chassis.



Do not cut the non-conductive bag to remove the module. Damage could result from sharp objects contacting the board or components.

The 6E12X-26 and 6E13X-25 can be installed in any of the 5 slots that are available. To install a module, proceed as follows:

1. Remove the blank panel covering the slot in which the module will be installed. All other slots must remain covered to ensure proper airflow and cooling. (Save the blank plate in the event you need to remove the module.)
2. Carefully remove the module from the shipping box. (Save the box and packing materials in the event the module must be reshipped.)
3. Locate the antistatic wrist strap shipped with the 6C105 chassis. Attach the strap to your wrist and plug the cable from the antistatic wrist strap into the ESD grounding receptacle at the upper right corner of the 6C105.

4. Remove the module from the plastic bag. (Save the bag in the event the module must be reshipped.) Observe all precautions to prevent damage from Electrostatic Discharge (ESD).
5. Examine the module for damage. If any damage exists, **DO NOT** install the module. Immediately contact the Cabletron Systems Global Call Center.



To prevent damaging the backplane connectors in the following step, take care that the module slides in straight and properly engages the backplane connectors.



In the following step, ensure that the top plastic locking tab lines up with the desired slot number located on the front panel of the chassis. Refer to [Figure 3-1](#).

6. Locate the slot guides that line up with the number of the slot in which the module will be installed. Install the module in the chassis by aligning the module circuit card between the upper and lower metal rail guides of the desired slot, sliding it into the chassis, and locking down the top and bottom plastic locking tabs, as shown in [Figure 3-1](#). Take care that the module slides in straight and properly engages the backplane connectors.

3.5 CONNECTING TO THE NETWORK

This section provides the procedures for connecting segments from the network or other devices to the modules.



If the 6E12X-26 and 6E13X-25 are being installed in a network using SmartTrunking, there are rules concerning the network cable and port configurations that must be followed for SmartTrunking to operate properly. Before connecting the cables refer to the Cabletron Systems *SmartTrunk User's Guide* shipped with the modules..

Ports 1 through 24 on the 6E122-26 and 6E132-25 have RJ45 connectors for twisted pair connections. Ports 1 through 24 on the 6E123-26 and 6E133-25 have RJ21 connectors for twisted pair connections. Ports 25 and 26 of the 6E12X-26 support FE-100TX, FE-100FX, or FE-100F3 Fast Ethernet Interface Modules. The FE-100TX has an RJ45 connector for a Category 5 UTP cable connection. The FE-100FX has an SC style connector for a multimode fiber optic cable connection. The FE-100F3 has an SC style connector for a single mode fiber optic cable connection.

Refer to [Section 3.5.1](#) to make twisted pair connections to ports 1 through 24 of the 6E122-26 and 6E132-25.

Refer to [Section 3.5.2](#) to make twisted pair connections to ports 1 through 24 of the 6E123-26 and 6E133-25.

Refer to [Section 3.5.3](#) to make a Twisted Pair connection to an FE-100TX.

Refer to [Section 3.5.4](#) to make a fiber optic connection to an FE-100FX or FE-100F3.

3.5.1 Connecting UTP Cables to Ports 1 Through 24 of the 6E122-26 and 6E132-25

Ports 1 through 24 of the 6E122-26 and 6E132-25 are 10BASE-T ports with internal crossovers. When connecting a workstation, use a straight-through cable. When connecting networking devices, such as another bridge, repeater, or router, use a crossover cable.

Connect a twisted pair segment to the 6E122-26 and 6E132-25 as follows:

1. Ensure that the device connected to the other end of the segment is powered ON.
2. Connect the twisted pair segment to the 6E132-25 or 6E122-26 by inserting the RJ45 connector on the twisted pair segment into the desired RJ45 port (Ports 1 through 24) as shown in Figure 3-2.

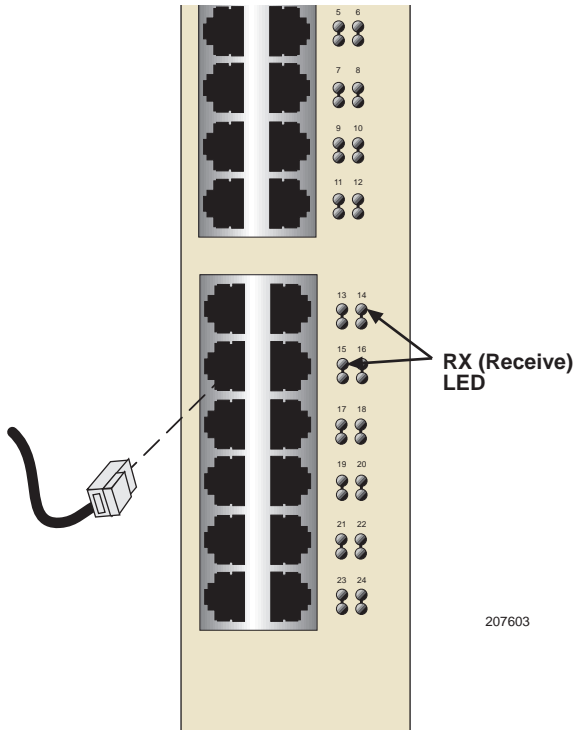

Figure 3-2 6E122-26 and 6E132-25 Twisted Pair Connection

3. Verify that a link exists by checking that the port **RX** LED is on (flashing amber, blinking green, or solid green). If the **RX** LED is off, perform the following steps until it is on:
 - a. Verify that the 10BASE-T device at the other end of the twisted pair segment is ON and connected to the segment.
 - b. Verify that the RJ45 connectors on the twisted pair segment have the proper pinouts ([Figure 3-3](#)) and check the cable for continuity.

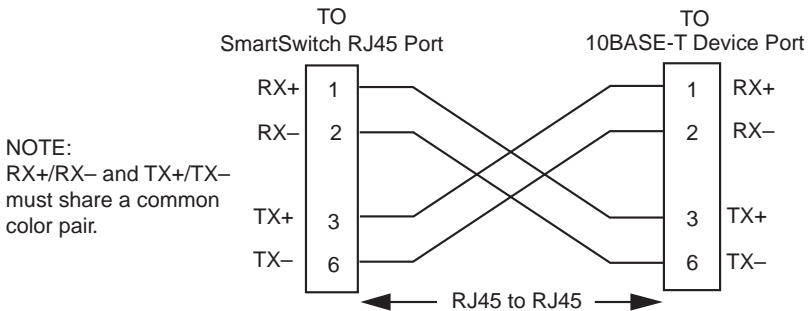

Figure 3-3 Cable Pinouts - (RJ45) Crossover Cable

- c. Check that the twisted pair connection meets the dB loss and cable specifications outlined in [Chapter 2](#).

If a link is not established, contact the Cabletron Systems Global Call Center. Refer to [Section 1.6, Getting Help](#), for details.

4. Repeat steps 1 through 3, above, until all connections have been made.

3.5.2 Connecting UTP Cables to Ports 1 Through 24 of the 6E133-25 and 6E123-26

When facing the front panel of the 6E133-25 or 6E123-26, the upper RJ21 is the connector for 10BASE-T ports 1 through 12. The lower RJ21 is for 10BASE-T ports 13 through 24. All 24 ports have internal crossovers.

Connect a twisted pair segment to the 6E133-25 and 6E123-26 as follows:

1. Ensure that the device connected to the other end of the segment is powered ON.
2. If using an RJ21 straight connector, plug it into the appropriate RJ21 port as shown in Figure 3-4 or, if using the RJ21 angle adapter supplied with the device, insert the RJ21 angle adapter as shown in Figure 3-5. The RJ21 angle adapter allows the cable to be inserted without interfering with the proper attachment of the second connector.

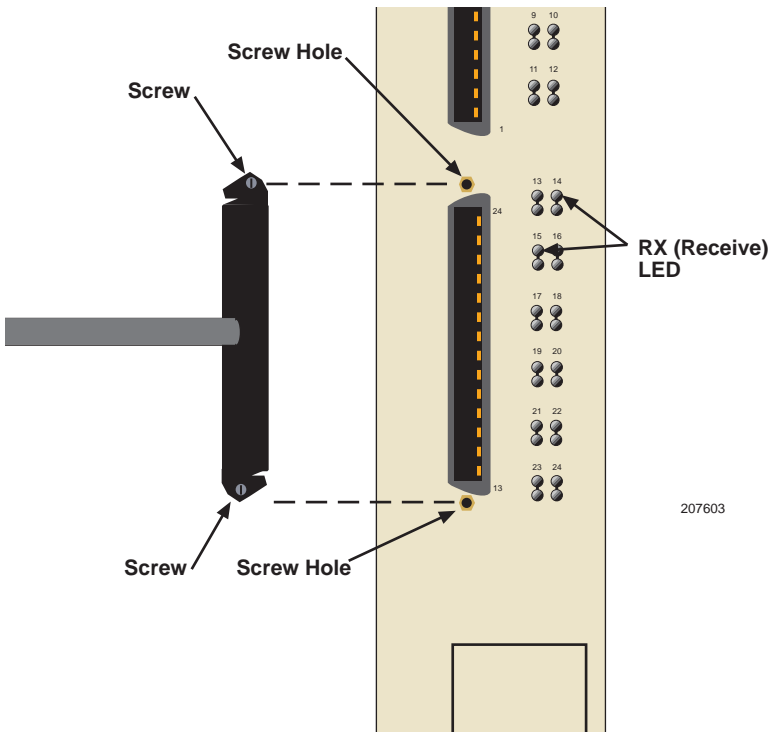

Figure 3-4 6E133-25 and 6E123-26 Twisted Pair Connection

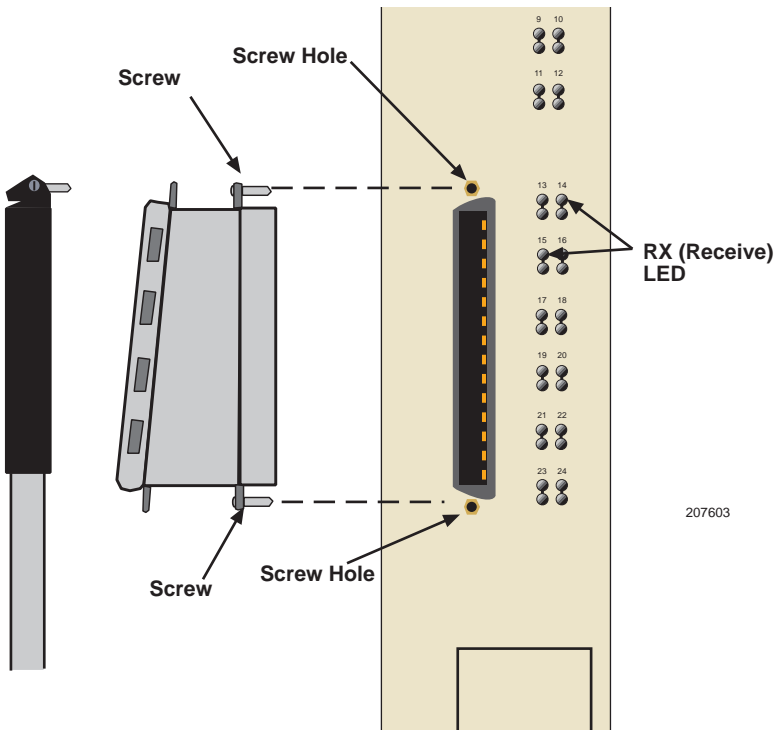
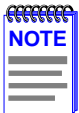

Figure 3-5 Connection Using the RJ21 Angle Adapter

3. Tighten the two screws on the RJ21 connector or RJ21 angle adapter, as applicable, to secure it to the module.



The cable pinouts for a 25 pair cable (RJ21) can be found in the Cabletron Systems *Cabling Guide*. Refer to [Section 1.7, Related Manuals](#), for details on how to obtain this document.

4. If using the RJ21 angle adapter, plug the 25 pair cable into the adapter as shown in [Figure 3-5](#).
5. Verify that a link exists by checking that the port **RX** LEDs are on (flashing amber, blinking green, or solid green). If the **RX** LEDs are off, perform the following steps until it is on:
 - a. Verify that the 10BASE-T device at the other end of the twisted pair segment is ON and connected to the segment.

- b. Verify that the RJ21 connectors on the twisted pair segment have the proper pinouts and check the cable for continuity.
- c. Check that the twisted pair connection meets the dB loss and cable specifications outlined in Chapter 2.

If a link is not established, contact the Cabletron Systems Global Call Center. Refer to Section 1.6, **Getting Help**, for details.

6. Repeat steps 1 through 4, above, until all connections have been made.

3.5.3 Connecting a Twisted Pair Segment to the FE-100TX

An FE-100-TX installed in port 25 and/or 26 has an internal crossover switch. When connecting a workstation, use a straight-through cable and set the Fast Ethernet Interface Module crossover switch shown in Figure 3-6 to the crossed over position marked with **X**. When connecting networking devices, such as another bridge, repeater, or router, use a straight-through cable and set the Fast Ethernet Interface Module crossover switch shown in Figure 3-6 to the not crossed over position, marked with **=**.

A schematic of a crossover cable is shown in Figure 3-6. If the wires do not cross over, use the switch on the FE-100TX to internally cross over the RJ45 port. Figure 3-6 shows how to properly set the FE-100TX crossover switch.

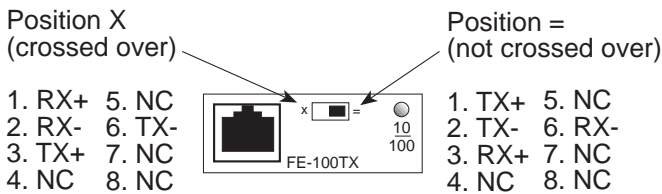

Figure 3-6 FE-100TX Crossover Switch

16651_05

Connect an FE-100TX to a twisted pair segment as follows:

1. Ensure that the device connected to the other end of the segment is powered ON.
2. Connect the twisted pair segment to the module by inserting the RJ45 connector on the twisted pair segment into the RJ45 port on the module shown in [Figure 3-6](#).
3. Verify that a link exists by checking that the port **RX** LED is on (flashing amber, blinking green, or solid green). If the **RX** LED is off, perform the following steps until it is on:
 - a. Verify that the 100BASE-TX device at the other end of the twisted pair segment is powered up.
 - b. Verify that the RJ45 connector on the twisted pair segment has the proper pinouts.
 - c. Check the cable for continuity.
 - d. Make sure that the twisted pair connection meets dB loss and cable specifications outlined in [Section 2.3](#).
 - e. Confirm that the crossover switch is in the correct position.

If a link is not established, contact the Cabletron Systems Global Call Center. Refer to [Section 1.6, Getting Help](#), for details.

3.5.4 Connecting a Fiber Optic Segment to the FE-100FX and FE-100F3

The FE-100FX and FE-100F3 have an SC style network port (see [Figure 3-7](#)). Cabletron Systems supplies fiber optic cable that uses SC style connectors that are keyed to ensure proper crossing over of the transmit and receive fibers.



An odd number of crossovers (preferably one) must be maintained between devices so that the transmit port of one device is connected to the receive port of the other device and vice versa.

If the fiber optic cable being used has SC style connectors that do not resemble MIC style connectors, or has SC connectors on one end and a different type on the other, such as ST connectors, ensure that the proper crossing over occurs.

Fiber Optic Network Connection

1. Remove the protective plastic covers from the fiber optic ports on the applicable port on the module and from the ends of the connectors.



The FE-100F3 uses Class 1 lasers. Do not use optical instruments to view the laser output. The use of optical instruments to view laser output increases eye hazard. When viewing the output optical port, power must be removed from the network adapter.



Do not touch the ends of the fiber optic strands, and do not let the ends come in contact with dust, dirt, or other contaminants. Contamination of the ends causes problems in data transmissions. If the ends become contaminated, clean them with alcohol using a soft, clean, lint-free cloth.

2. Insert one end of the SC connector into the FE-100FX or FE-100F3 installed in the 6E12X-26. See [Figure 3-7](#).
3. At the other end of the fiber optic cable, attach the SC connector to the other device.

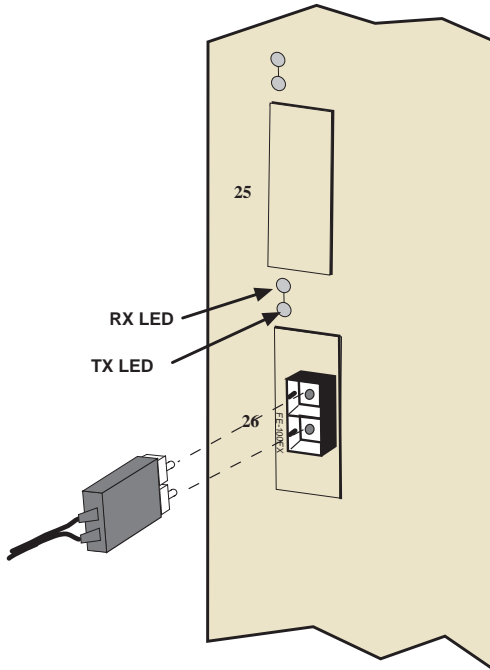
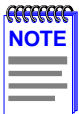

Figure 3-7 FE-100FX and FE-100F3 Port

4. Verify that a link exists by checking that the port **RX** LED is on (flashing amber, blinking green, or solid green). If the **RX** LED is off and the **TX** LED is not blinking amber, perform the following steps until it is on:



The port **RX** LED flashes green and amber during bootup.

- a. Check that the power is turned on for the device at the other end of the link.
- b. Verify proper crossing over of fiber strands between the applicable port on the 6E12X-26 and the fiber optic device at the other end of the fiber optic link segment.

- c. Verify that the fiber connection meets the dB loss specifications outlined in [Chapter 2](#).

If a link has not been established, contact the Cabletron Systems Global Call Center. Refer to [Section 1.6, Getting Help](#), for details.

3.6 COMPLETING THE INSTALLATION

The 6E12X-26 and 6E13X-25 are now ready to be set up through Local Management. Refer to [Chapter 5, Local Management](#), to configure the modules and 6C105 chassis.

CHAPTER 4

TROUBLESHOOTING

This chapter provides information concerning the following:

- Using the LANVIEW diagnostic and status monitoring system
- Troubleshooting network and module operational problems
- Using the RESET button

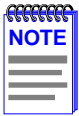

The four interface modules covered in this manual all share the same LANVIEW LEDs.

4.1 USING LANVIEW

The 6E12X-26 and 6E13X-25 use Cabletron Systems built-in visual diagnostic and status monitoring system called LANVIEW. The LANVIEW LEDs ([Figure 4-1](#)) allow quick observation of the network status to aid in diagnosing network problems. Refer to [Table 4-1](#) for a description of the LEDs.

For a functional description of the LANVIEW LED on the optional Fast Ethernet Interface Module (FE-100TX), refer to [Section 4.2](#).

All LEDs for the High Speed Interface Module (HSIM) are located on the HSIM and are described in the associated HSIM user's guide.



The terms **flashing**, **blinking**, and **solid** used in the LED definition tables of this chapter indicate the following:

Flashing indicates an irregular LED pulse.

Blinking indicates a steady LED pulse.

Solid indicates a steady LED light. No pulsing.

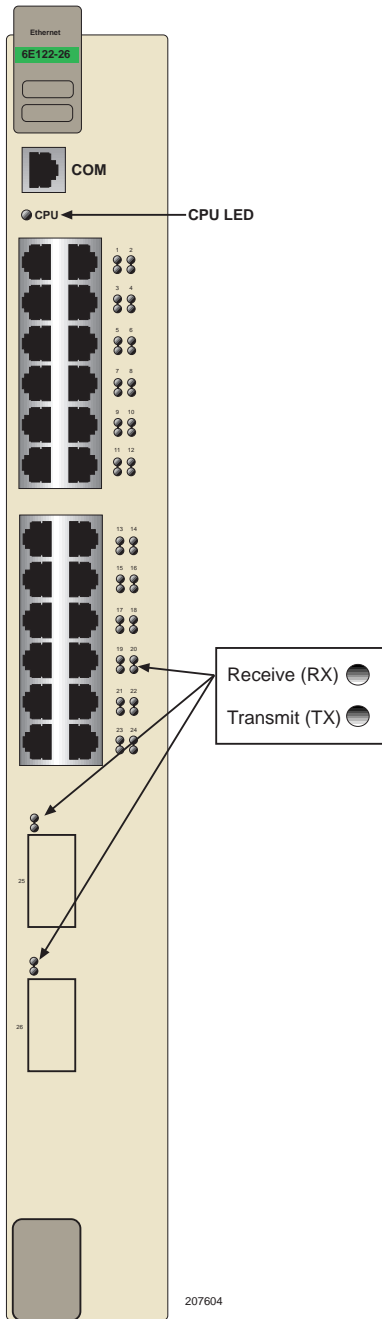

Figure 4-1 LANVIEW LEDs

Table 4-1 LANVIEW LEDs

LED	Color	State	Recommended Action
CPU	Off	Power off.	Power up chassis.
	Red	Blinking. Hardware failure has occurred.	Contact the Cabletron Systems Global Call Center (GCC).
		Solid. Resetting, normal power up reset.	No action. If LED remains Red for several minutes, contact the Cabletron Systems GCC.
	Amber	Blinking. Crippled.	Contact the Cabletron Systems GCC.
		Solid. Testing.	No action. If LED remains Amber for several minutes, contact the Cabletron Systems GCC.
	Green	Solid. Functional.	No action.
	Amber and Green	Booting. Blinks amber and green while booting.	No action.
RX	Off	No link. No activity. Port enabled or disabled.	No error.
	Green	Solid. Port enabled, link, no activity.	No error.
		Blinking. Port disabled, link.	No error.
	Amber	Flashing. Port enabled, link, activity.	No error.
	Red	Diagnostic failure.	Contact the Cabletron Systems GCC for assistance.

Table 4-1 LANVIEW LEDs (Continued)

LED	Color	State	Recommended Action
TX	Off	Port enabled, and no activity.	Should flash green every 2 seconds indicating BPDUs being sent if STA is enabled and there is a valid link. If STA is enabled, and the LED does not flash green, contact the Cabletron Systems GCC.
	Green	Flashing. Indicates activity. Rate indicates data rate.	No action.
	Amber	Blinking. Port in standby, link.	Port may be disabled due to Spanning Tree.
	Red	Flashing. Indicates collision rate.	No action.
		Solid. Diagnostic Failure.	Contact the Cabletron Systems GCC for assistance.

4.2 FE-100TX LED

The optional FE-100TX has one LED labeled 10/100. The 10/100 LED together with the receive LED allows the user to determine the link status and the operating speed of the Fast Ethernet Interface Module. The 10/100 LED and the Receive (RX) LED are shown in [Figure 4-2](#). [Table 4-2](#) and [Table 4-3](#) provide a functional description of the FE-100TX LED when the RX LED is on or off, respectively.

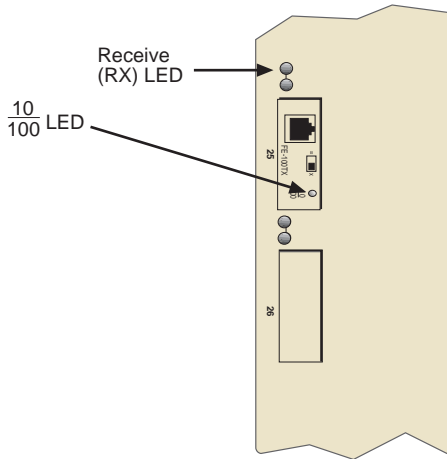
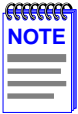

Figure 4-2 FE-100TX LED



A link exists if the associated port (port 25 or 26) Receive (RX) LED is on.

Table 4-2 FE-100TX LED Indications When the RX LED Is On

LED	Color	Description
10/100	Off	FE-100TX is operating at 10 Mbps.
	Green	FE-100TX is operating at 100 Mbps.

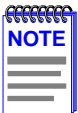

No link exists if the associated port (port 25 or 26) Receive (RX) LED is off.

Table 4-3 FE-100TX LED Indications When the RX LED Is Off

LED	Color	Description
10/100	Off	No link or no cable attached. FE-100TX forced to 10 Mbps operation, or is manually set to "auto-negotiate" mode.
	Green	No link or no cable attached. FE-100TX is forced to 100 Mbps operation.

4.3 TROUBLESHOOTING CHECKLIST

If the 6E12X-26 or 6E13X-25 is not working properly, refer to [Table 4-4](#) for a checklist of possible problems, causes, and recommended actions to resolve the problem.

Table 4-4 Troubleshooting Checklist

Problem	Possible Cause	Recommended Action
All LEDs are OFF.	Loss of power to the 6C105 chassis.	Check the proper connection of the power cable and its access to a live outlet.
	6E13X-25 or 6E12X-26 not properly installed.	Check the installation.
No Local Management Password screen.	Autobaud enabled. But baud rate has not yet been sensed.	Press ENTER (RETURN) (may take up to four times).
	Terminal setup is not correct.	Refer to Chapter 5 for proper setup procedures.
	Improper console cable pinouts.	Refer to Appendix A for proper console port pinouts.
Cannot contact the 6E132-25 or 6E122-26 from in-band management.	Improper Community Names Table.	Refer to Chapter 5 for Community Names Table setup.
	6E12X-26 or 6E13X-25 does not have an IP address.	Refer to Chapter 5 for IP address assignment procedure.
	Port is disabled.	Enable port.
	No link to device.	Check link to device.
Port(s) goes into standby for no apparent reason.	6E12X-26 or 6E13X-25 detects a looped condition.	Review network design and delete unnecessary loops.
User parameters (IP address, Device and Module name, etc.) are lost when the 6E12X-26 or 6E13X-25 is powered down or the front panel RESET button is pressed.	Mode switch (7), NVRAM Reset, was changed sometime before either cycling power or pressing the RESET button, causing the user-entered parameters to reset to factory default settings.	Reenter the lost parameters as necessary. Call the Cabletron Systems GCC if problem continues.

4.4 USING THE RESET BUTTON

The RESET button located near the upper plastic locking tab of the module (refer to [Figure 4-3](#)) resets the 6E12X-26 and 6E13X-25 processor without affecting the NVRAM.



Pressing the RESET button resets the device, and all current switching being performed by the device is halted. A module downtime of up to two minutes will result from this action.

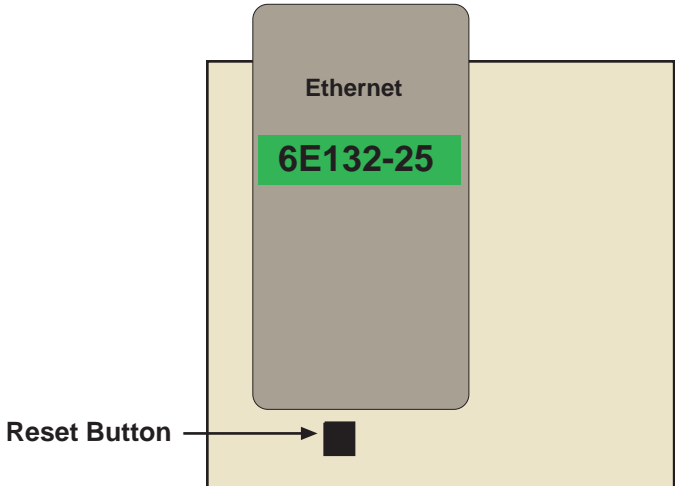

Figure 4-3 RESET Button

To reset the 6E12X-26 and 6E13X-25 processor, press and release the RESET button. The module processor goes through a reset process of approximately 20 seconds. Additional module downtime may be added as the module reenters the network.

CHAPTER 5

LOCAL MANAGEMENT

This chapter explains how to set up a management terminal to access 6E12X-26 and 6E13X-25 Local Management. It also explains how to use the Local Management screens and commands.



The Local Management screens shown in this chapter are for the 6E122-26. The 6E132-25, 6E133-25 and 6E123-26 share most of the following Local Management screens. All Local Management functions specific to any of the interface modules are preceded by a Note to alert the reader.

5.1 OVERVIEW

Local Management for the 6E12X-26 and 6E13X-25 consists of a series of management screens that allow the management of the module, the attached segments and the 6C105 chassis. The management screens allow the user to perform the following tasks:

- Manage any interface module in the chassis via a connection to a single interface module.
- Assign IP addresses and subnet masks to the 6E12X-26, 6E13X-25 and the 6C105 chassis.
- Control access to the 6E12X-26, 6E13X-25 and the 6C105 chassis by establishing community names.
- Download a new image of operating software.
- Designate which Network Management Workstations receive SNMP traps from the 6E12X-26, 6E13X-25 and the 6C105 chassis.
- Monitor the environmental status of the 6C105 chassis.
- View switch, interface, and RMON statistics.
- Assign ports to operate in standard or full duplex mode.
- Enable trunking of ports to perform load sharing.
- Configure the Fast Ethernet Interface Modules of the 6E12X-26 and the HSIM of the 6E13X-25.

There are three ways to access Local Management:

- Locally using a VT type terminal connected to the COM port of the 6E13X-25 or 6E12X-26.
- Remotely using a VT type terminal connected through a modem.
- In-band through a Telnet connection.

5.2 LOCAL MANAGEMENT KEYBOARD CONVENTIONS

All key names appear as capital letters in this manual. [Table 5-1](#) explains the keyboard conventions and the key functions that are used.

Table 5-1 Keyboard Conventions

Key	Function
ENTER Key RETURN Key	These are selection keys that perform the same Local Management function. For example, "Press ENTER" means that you can press either ENTER or RETURN, unless this manual specifically instructs you otherwise.
ESCAPE (ESC) Key	This key allows an escape from a Local Management screen without saving changes. For example, "Press ESC twice" means the ESC key must be pressed quickly two times.
SPACE bar BACKSPACE Key	These keys cycle through selections in some Local Management fields. Use the SPACE bar to cycle forward through selections and use BACKSPACE to cycle backward through selections.
Arrow Keys	These are navigation keys. Use the UP-ARROW, DOWN-ARROW, LEFT-ARROW, and RIGHT-ARROW keys to move the screen cursor. For example, "Use the arrow keys" means to press whichever arrow key moves the cursor to the desired field on the Local Management screen.
[–] Key	This key decreases values from a Local Management increment field. For example, "Press [–]" means to press the minus sign key.
DEL Key	The DEL (Delete) key removes characters from a Local Management field. For example, "Press DEL" means to press the Delete key.

5.3 MANAGEMENT TERMINAL SETUP

Use one of the following systems to access Local Management:

- An IBM or compatible PC running a VT series emulation software package
- A Digital Equipment Corporation VT100 type terminal
- A VT type terminal running emulation programs for the Digital Equipment Corporation VT100 series
- A remote VT100 type terminal via a modem connection
- In-band via a Telnet connection

5.3.1 Console Cable Connection

Use the Console Cable Kit provided with the 6C105 chassis to attach the management terminal to the COM port as shown in [Figure 5-1](#).

Connect an IBM PC or compatible device, running the VT terminal emulation, to the 6E12X-26 and 6E13X-25 as follows:

1. Connect the RJ45 connector at one end of the cable (supplied in the kit) to the COM port on the 6E12X-26 and 6E13X-25.
2. Plug the RJ45 connector at the other end of the cable into the RJ45-to-DB9 adapter (supplied in the kit).
3. Connect the RJ45-to-DB9 adapter to the PC communications port.

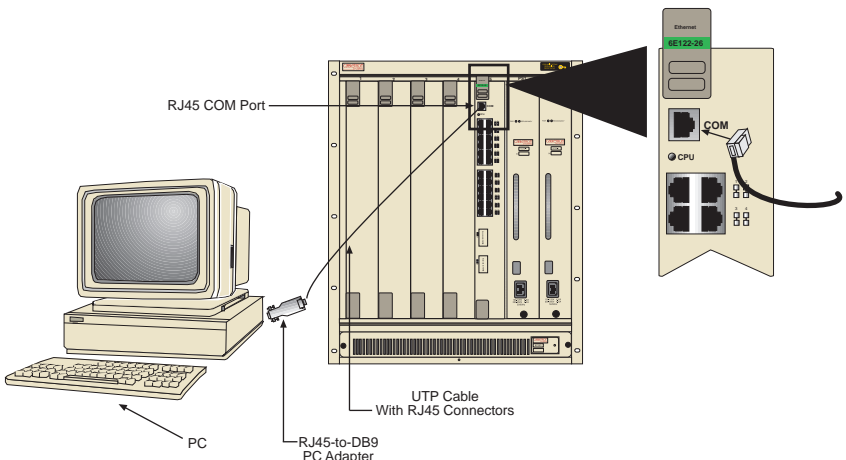

Figure 5-1 Management Terminal Connection

5.3.2 Connecting an Uninterruptible Power Supply (UPS)

If the 6C105 chassis is connected to an American Power Conversion (APC) UPS for protection from a loss of power, a connection from the COM port of a module to the UPS can be made to monitor the status of the UPS. To use the COM port for this purpose, it must be reconfigured to support the UPS application. This procedure is performed from the General Configuration screen of the interface module. [Section 5.15.11, Configuring the COM Port](#), provides detailed instructions on configuring the COM port for UPS applications. Refer to the UPS documentation for details on how to access the status information.

Use the Console Cable Kit provided with the 6C105 chassis to attach the UPS to the module COM port as shown in [Figure 5-2](#).

Connect the UPS device to the COM port of the 6E12X-26 and 6E13X-25 as follows:

1. Connect the RJ45 connector at one end of the cable to the COM port on the 6E12X-26 and 6E13X-25.
2. Plug the RJ45 connector at the other end of the cable into the RJ45-to-DB9 male (UPS) adapter, Cabletron Systems Part No. 9372066.
3. Connect the RJ45-to-DB9 male (UPS) adapter to the female DB9 port on the rear of the UPS device (refer to the particular UPS device's user instructions for more specific information about the monitoring connection).

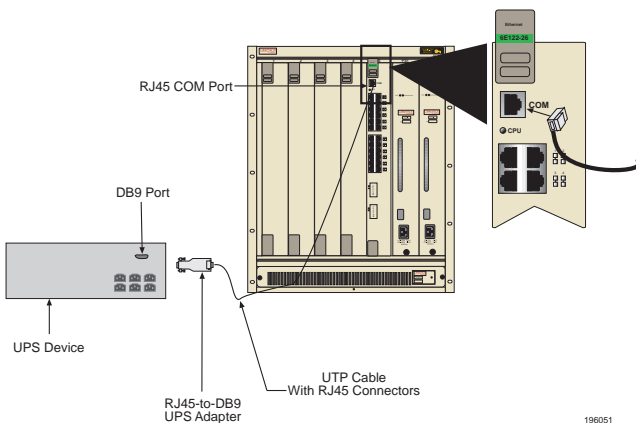

Figure 5-2 Uninterruptible Power Supply (UPS)

5.3.3 Management Terminal Setup Parameters

Table 5-2 lists the setup parameters for the local management terminal.

Table 5-2 VT Terminal Setup

Display Setup Menu	
Columns ->	80 Columns
Controls ->	Interpret Controls
Auto Wrap ->	No Auto Wrap
Scroll ->	Jump Scroll
Text Cursor ->	Cursor
Cursor Style ->	Underline Cursor Style
General Setup Menu	
Mode ->	VT100, 7 Bit Controls
ID number ->	VT100ID
Cursor Keys ->	Normal Cursor Keys
Power Supply ->	UPSS DEC Supplemental
Communications Setup Menu	
Transmit ->	2400, 4800, 9600, 19200
Receive ->	Receive=Transmit
XOFF ->	XOFF at 64
Bits ->	8 bits
Parity ->	No Parity
Stop Bit ->	1 Stop Bit
Local Echo ->	No Local Echo
Port ->	DEC-423, Data Leads Only
Transmit ->	Limited Transmit
Auto Answerback ->	No Auto Answerback
Keyboard Setup Menu	
Keys ->	Typewriter Keys
Auto Repeat ->	any option
Keyclick ->	any option
Margin Bell ->	Margin Bell
Warning Bell ->	Warning Bell

5.3.4 Telnet Connections

Once the module or chassis has a valid IP address, the user can establish a Telnet session with Local Management from any TCP/IP based node on the network. Telnet connections to the 6E12X-26 and 6E13X-25 require the community name passwords assigned at the SNMP Community Names screen of either the 6C105 chassis, or the module. For additional information about community names, refer to **Section 5.8, SNMP Community Names Screen**. Refer to the instructions included with the Telnet application for information about establishing a Telnet session.



The User's password is one of the community names specified in the SNMP Community Names screen. Access to certain Local Management capabilities depends on the degree of access accorded that community name. Refer to [Section 5.8](#).

- If an invalid password is entered, the terminal beeps and the cursor returns to the beginning of the password entry field.
- Entering a valid password causes the associated access level to display at the bottom of the screen and the Main Menu screen to appear.
- If no activity occurs for several minutes, the Password screen reappears and the session ends.

5.4.1 Navigating Local Management Screens

The 6E12X-26 and 6E13X-25 Local Management application consists of a series of menu screens. Navigate through Local Management by selecting items from the menu screens.

The 6E12X-26 and 6E13X-25 support three modes of switch operation. The switching modes are as follows:

- 802.1D SWITCHING, (traditional switching)
- 802.1Q SWITCHING, (802.1Q port based VLANs)
- SECURE FAST VLAN, (Cabletron Systems SecureFast Switching)



Refer to the Release Notes shipped with the product to verify which screens are supported in each of the three available switching modes.

The switch operational mode may be set in either the Chassis Configuration screen ([Section 5.7](#)), or the General Configuration screen of the module ([Section 5.15](#)). Depending on the Operational Mode set for the module, the hierarchy of Local Management screens differs as shown in [Figure 5-4](#), [Figure 5-7](#), and [Figure 5-8](#). Refer to the appropriate figure that relates to the Operational Mode that will be set for the module to see the applicable Local Management screen hierarchy.

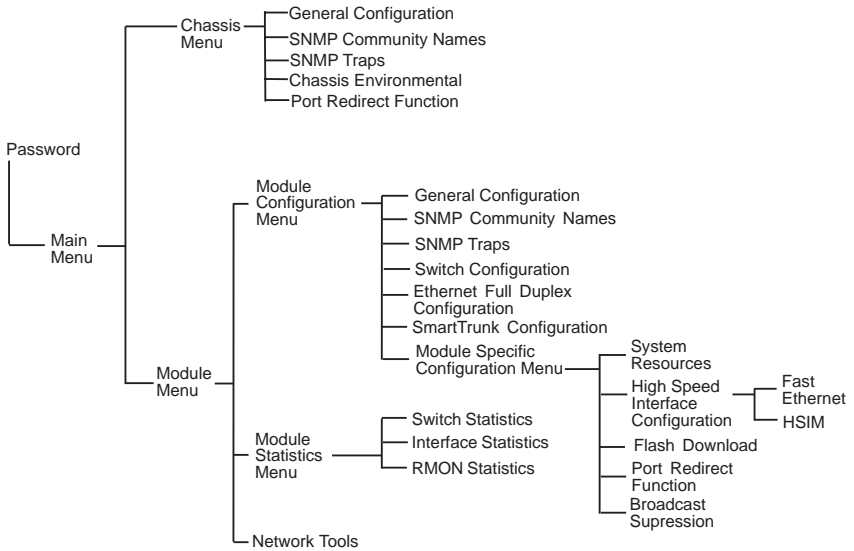

Figure 5-4 802.1D Switching Mode, LM Screen Hierarchy

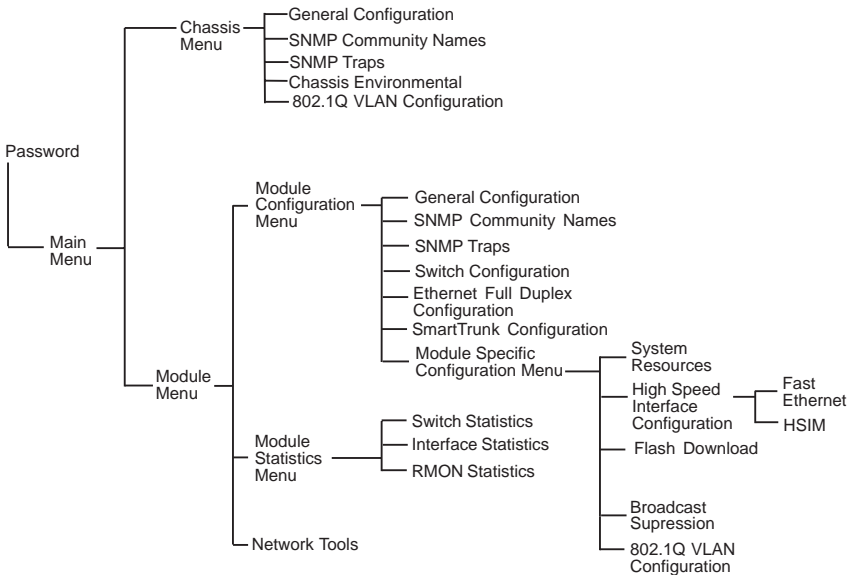

Figure 5-5 802.1Q Switching Mode, LM Screen Hierarchy

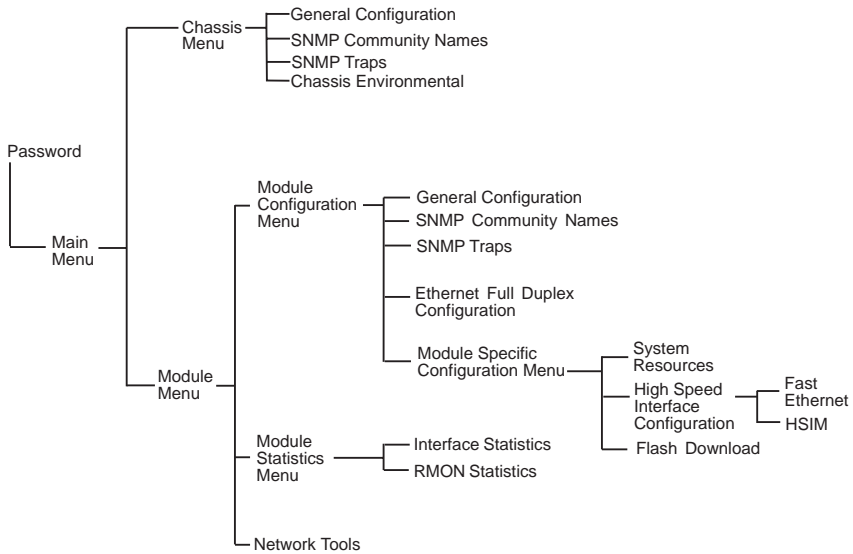

Figure 5-6 SecureFast VLAN Mode, LM Screen Hierarchy

5.4.2 Selecting Local Management Menu Screen Items

Select items on a menu screen by performing the following steps:

1. Use the arrow keys to highlight a menu item.
2. Press ENTER. The selected menu item displays on the screen.

5.4.3 Exiting Local Management Screens

There are two ways to exit Local Management (LM).

Using the EXIT Command

To exit an LM screen using the **EXIT** command, proceed as follows:

1. Use the arrow keys to highlight the **EXIT** command at the bottom of the Local Management screen.
2. Press ENTER. The Password screen displays and the session ends.

Using the RETURN Command

1. Use the arrow keys to highlight the **RETURN** command at the bottom of the Local Management screen.
2. Press ENTER. The previous screen in the Local Management hierarchy displays.

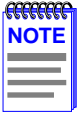

The user can also exit Local Management screens by pressing ESC twice. This exit method does not warn about unsaved changes and all unsaved changes will be lost.

3. Exit from 6E12X-26 and 6E13X-25 Local Management by repeating steps 1 and 2 until the Main Menu screen displays.
4. Use the arrow keys to highlight the **RETURN** command at the bottom of the Main Menu screen.
5. Press ENTER. The Password screen displays and the session ends.

5.5 THE MAIN MENU SCREEN

The Main Menu screen is the access point for all Local Management screens for the module and the 6C105 chassis. Figure 5-7 shows the Main Menu screen.

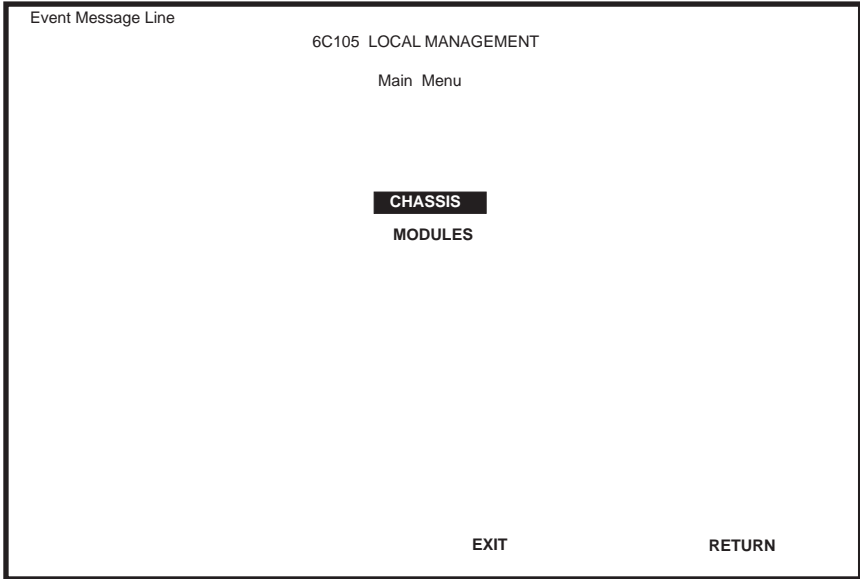

1960_91

Figure 5-7 Main Menu Screen

The following explains each Main Menu screen item as shown in Figure 5-7:

CHASSIS

The **CHASSIS** menu item provides access to the Chassis Menu screen, shown in Figure 5-8, that is used to configure the 6C105 chassis, access current chassis power supply and environmental status, and to configure IEEE 802.1Q VLANs.

Access the Chassis Configuration screen by using the arrow keys to highlight the **CHASSIS** menu item and pressing ENTER. The Chassis Configuration screen displays. Proceed to Section 5.6.

MODULES

The **MODULES** menu item provides access to the Module Selection screen that is used to select individual modules in the chassis for management purposes.

Access the Module Selection screen by using the arrow keys to highlight the **MODULES** menu item and pressing ENTER. The Module Selection screen displays. Proceed to [Section 5.12](#).

5.6 CHASSIS MENU SCREEN

The Chassis Menu screen, [Figure 5-8](#), provides access to Local Management screens that allow you to configure and monitor operating parameters, modify SNMP community names, set SNMP traps, monitor the 6C105 environmental status, perform port redirect functions, and to configure the 6C105 for IEEE 802.1Q operation.

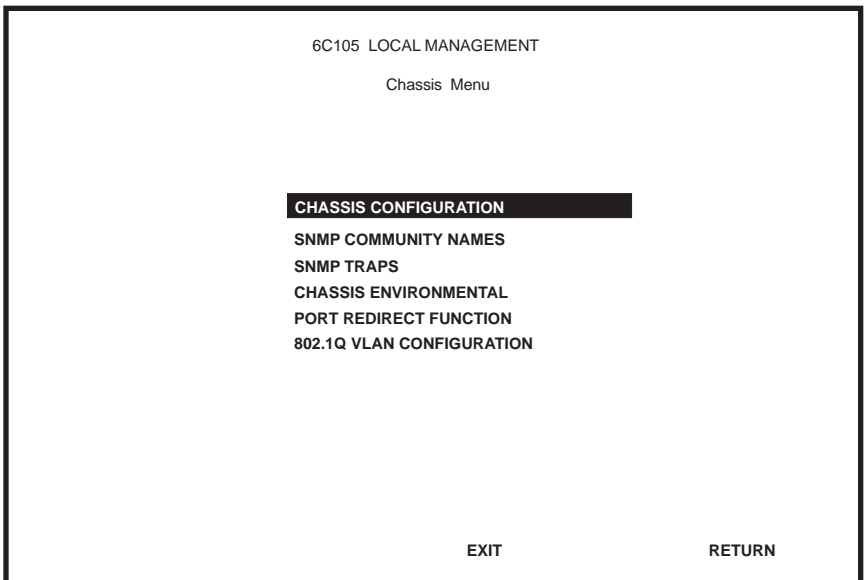

2269_99

Figure 5-8 Chassis Menu Screen

The following briefly explains each screen accessible from the Chassis Menu screen.

CHASSIS CONFIGURATION

The Chassis Configuration screen allows the user to configure operating parameters for the 6C105 chassis. For details, refer to [Section 5.7](#).

SNMP COMMUNITY NAMES

The SNMP Community Names screen allows the user to enter new, change, or review the community names used as access passwords for device management operation. Access is limited based on the password level of the user. For details, refer to [Section 5.8](#).

SNMP TRAPS

The SNMP Traps screen provides display and configuration access to the table of IP addresses used for trap destinations and associated community names. For details, refer to [Section 5.9](#).

CHASSIS ENVIRONMENTAL

The Chassis Environmental screen provides access to chassis power supply status, power supply redundancy status and chassis fan tray status. For details, refer to [Section 5.10](#).

PORT REDIRECT FUNCTION

The Port Redirect Function screen allows the user to redirect traffic from one or multiple modules and ports in the chassis to a specific destination module or port. For details, refer to [Section 5.11](#).

802.1Q VLAN CONFIGURATION

This menu item will only display if one or more modules installed the chassis have been configured to operate as IEEE 802.1Q switches. When selected, this menu item opens the VLAN Main Menu screen. For details, refer to the Cabletron Systems *Port Based VLAN User's Guide*.

[Section 5.7.7, Setting the Operational Mode](#), describes how to configure the modules to function as 802.1Q switches.

5.7 CHASSIS CONFIGURATION SCREEN

The Chassis Configuration screen, [Figure 5-9](#), allows the user to set the chassis date and time, IP address and Subnet Mask, the operational mode of all modules installed in the chassis, and to view the chassis uptime.

Access the Chassis Configuration screen from the Chassis Menu screen by using the arrow keys to highlight the **CHASSIS CONFIGURATION** menu item and pressing ENTER. The Chassis Configuration screen, [Figure 5-9](#), displays.

```

Event Message Line
                                6C105 LOCAL MANAGEMENT
                                Chassis Configuration

MAC Address:                    00-00-ID-00-00-00          Chassis Date:                10/11/97
IP Address:                     000.000.000.000          Chassis Time:                14:23:00
Subnet Mask:                    000.000.000.000          Screen Refresh Time:         30 sec.
                                                                    Screen Lockout Time:         15 min.
                                                                    Chassis Uptime              XX D XX H XX M

Operational Mode: [802.1D SWITCHING]

SAVE                               EXIT                               RETURN
    
```

1960_98

Figure 5-9 Chassis Configuration Screen

The following briefly explains each Chassis Configuration screen field:

MAC Address (Read-Only)

Displays the base physical address of the chassis.

IP Address (Modifiable)

This field allows the IP address to be set for the 6C105 chassis. If an IP address is assigned to the 6C105 chassis all the interface modules installed in the chassis can be managed via this IP address, eliminating the need to assign an IP address to each interface module. To set the IP address, refer to [Section 5.7.1](#).

Subnet Mask (Modifiable)

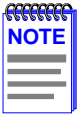

When a valid IP address is assigned, the Subnet Mask field automatically enters the default mask that corresponds with class of IP entered in the IP Address field. Some firmware revisions do support changing the chassis subnet mask from the default value. Refer to your Release Notes to ensure that the Subnet Mask is a modifiable field.

Displays the subnet mask for the chassis. A subnet mask “masks out” the network bits of the IP address by setting the bits in the mask to 1 when the network treats the corresponding bits in the IP address as part of the network or subnetwork address, or to 0 if the corresponding bit identifies the host. The 6C105 chassis automatically uses the default subnet mask that corresponds to the IP class that was entered in the IP address field. [Section 5.7.2, Setting the Subnet Mask](#) describes how to change the subnet mask from the default value.

Chassis Date (Modifiable)

Contains a value that the chassis recognizes as the current date. When the chassis date is modified and saved all interface modules installed in the chassis are set to this date. To set a new chassis date, refer to [Section 5.7.3](#).

Chassis Time (Modifiable)

Contains a value that the chassis recognizes as the current time. When the chassis time is modified and saved, all interface modules installed in the chassis are set to this time. To enter a new time, refer to [Section 5.7.4](#).

Screen Refresh Time (Modifiable)

Contains the rate at which the screens are updated. This setting determines how frequently (in seconds) information is updated on the screen. To enter a new update time, refer to [Section 5.7.5](#).

Screen Lockout Time (Modifiable)

Contains the maximum number of minutes that the Local Management application displays a module's screen while awaiting input or action from a user. For example, if the number 5 is entered in this field, the user has up to five minutes to respond to each of the specified module's Local Management screens. In this example, after five minutes of "idleness" (no input or action), the terminal "beeps" five times, the Local Management application terminates the session, and the display returns to the Password screen. To enter a new lockout time, refer to [Section 5.7.6](#).

Chassis Uptime (Read-Only)

Displays the total time the chassis has been operating. The chassis uptime is based on which interface module installed in the chassis has been operating for the longest period of time.

Operational Mode (Toggle)

This field allows the user to set all the modules in the chassis to operate as traditional switches (802.1D SWITCHING option), or as IEEE 802.1Q switches (802.1Q SWITCHING option).

In 802.1D SWITCHING mode, the 24 ports located on the front panel, and each Fast Ethernet Interface Module, and HSIM port(s) are bridged to each other.

When the operational mode is set to 802.1Q SWITCHING, the 6E12X-26 and 6E13X-25 act as IEEE 802.1Q switches. The modules are able to increase their switching functionality by creating and maintaining port based Virtual LANs (VLANs).

For details on how to select the Operational Mode, refer to [Section 5.7.7](#).

5.7.1 Setting the IP Address

To set the IP address, perform the following steps:

1. Use the arrow keys to highlight the **IP Address** field.
2. Enter the IP address into this field using Decimal Dotted Notation (DDN) format.

For example: 134.141.79.120

3. Press ENTER. If the IP address is a valid format, the cursor returns to the beginning of the IP address field. If the entry is not valid, the Event Message Line displays “INVALID IP ADDRESS OR FORMAT ENTERED”. Local Management does not alter the current value and refreshes the IP address field with the previous value.
4. Use the arrow keys to highlight the **SAVE** command, then press ENTER. The “SAVED OK” message displays indicating that the changes have been saved to memory.

5.7.2 Setting the Subnet Mask

If the management workstation that is to receive SNMP traps from the 6C105 is located on a separate subnet, the subnet mask for the 6C105 must be changed from its default.

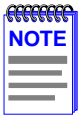

When a valid IP address is assigned, the Subnet Mask field automatically enters the default mask that corresponds with class of IP entered in the IP Address field. Some firmware revisions do support changing the chassis subnet mask from the default value. Refer to your Release Notes to ensure that the Subnet Mask is a modifiable field.

To change the subnet mask from its default, perform the following steps:

1. Use the arrow keys to highlight the **Subnet Mask** field.
2. Enter the subnet mask into this field using Decimal Dotted Notation (DDN) format.
For example: 255.255.255.0
3. Press ENTER. If the subnet mask is valid, the cursor returns to the beginning of the Subnet Mask field. If the entry is not valid, the Event Message Line displays “INVALID SUBNET MASK OR FORMAT ENTERED”. Local Management does not alter the current value, but it does refresh the Subnet Mask field with the previous value.
4. Use the arrow keys to highlight the **SAVE** command, then press ENTER. The changes are saved to memory.

5.7.3 Setting the Chassis Date

The 6C105 is year 2000 compliant, so the Chassis Date may be set beyond the year 1999. To set the chassis date, perform the following steps:

1. Use the arrow keys to highlight the **Chassis Date** field.
2. Enter the date in an MM/DD/YYYY format.



It is not necessary to add separators between month, day, and year numbers. For example, to set the date to 03/17/1997, type "03171997" in the Chassis Date field.

3. Press ENTER to set the system calendar to the date in the input field.
4. Use the arrow keys to highlight the **SAVE** command at the bottom of the screen and press ENTER.

If the date entered is a valid format, the Event Message Line at the top of the screen displays "SAVED OK". If the entry is not valid, Local Management does not alter the current value, but it does refresh the Chassis Date field with the previous value.



Upon saving the new chassis date, all interface modules installed in the chassis recognize the new value as the current date.

5.7.4 Setting the Chassis Time

To set the chassis clock, perform the following steps:

1. Use the arrow keys to highlight the **Chassis Time** field.
2. Enter the time in a 24-hour format, HH:MM:SS.

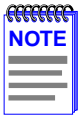

When entering the time in the system time field, separators between hours, minutes, and seconds do not need to be added as long as each entry uses two numeric characters. For example, to set the time to 6:45 A.M., type "064500" in the Chassis Time field.

3. Press ENTER to set the system clock to the time in the input field.
4. Use the arrow keys to highlight the **SAVE** command at the bottom of the screen and press ENTER.

If the time entered is a valid format, the Event Message Line at the top of the screen displays "SAVED OK". If the entry is not valid, Local Management does not alter the current value and refreshes the Chassis Time field with the previous value.

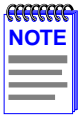

Upon saving the new chassis time, all interface modules installed in the chassis recognize the new value as the current time.

5.7.5 Entering a New Screen Refresh Time

The screen refresh time is set from 3 to 99 seconds with a default of 3 seconds. To set a new screen refresh time, perform the following steps:

1. Use the arrow keys to highlight the **Screen Refresh Time** field.
2. Enter a number from 3 to 99.
3. Press ENTER to set the refresh time to the time entered in the input field.
4. Use the arrow keys to highlight the **SAVE** command at the bottom of the screen and press ENTER.

If the time entered is within the 3 to 99 seconds range, the Event Message Line at the top of the screen displays "SAVED OK". If the entry is not valid, Local Management does not alter the current setting, but it does refresh the Screen Refresh Time field with the previous value.

5.7.6 Setting the Screen Lockout Time

The screen lockout time can be set from 1 to 30 minutes with a default of 15 minutes. To set a new lockout time, perform the following steps:

- 1.** Use the arrow keys to highlight the **Screen Lockout** field.
- 2.** Enter a number from 1 to 30.
- 3.** Press ENTER to set the lockout time in the input field.
- 4.** Use the arrow keys to highlight the **SAVE** command at the bottom of the screen and press ENTER.

If the time entered is within the 1 to 30 minutes range, the Event Message Line at the top of the screen displays “SAVED OK”. If the entry is not valid, Local Management does not alter the current setting, but it does refresh the Screen Lockout Time field with the previous value.

5.7.7 Setting the Operational Mode

To set the Operational Mode, proceed as follows:

1. Use arrow keys to highlight the **Operational Mode** field.
2. Press the SPACE bar to step to the appropriate operation mode, (**802.1D SWITCHING** or **802.1Q SWITCHING**).
3. Use the arrow keys to highlight the **SAVE** command at the bottom of the screen and press ENTER. The following warning screen displays:

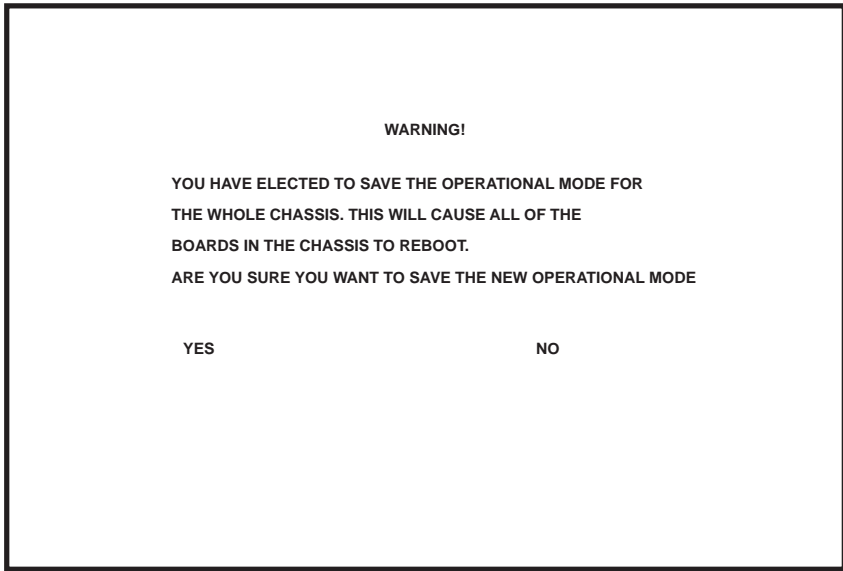

1666

Figure 5-10 Operational Mode Warning Screen

4. Use the arrow keys to highlight the **YES** command and press ENTER. The changes are saved, and all the modules installed in the chassis reboot.

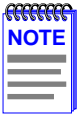

If the 6E12X-26 and 6E13X-25 have been set to **802.1Q SWITCHING**, refer to your *Port Based VLAN User's Guide* to configure the devices for this type of operation.

The Operational Mode field in the Chassis Configuration screen does not support the **SECURE FAST VLAN** operational mode. For the modules to function as SecureFast switches, they must have a unique IP addresses, and be configured to act as Standalone devices in terms of Local Management via the 6C105 chassis. [Section 5.15.9](#) provides additional instructions and rules that must be met before configuring the modules as SecureFast switches.

5.8 SNMP COMMUNITY NAMES SCREEN

The SNMP Community Names menu item allows the user to set Local Management community names. Community names act as passwords to Local/Remote Management and provide security access to the 6C105. Access to the 6C105 is controlled by enacting any of three different levels of security authorization (read-only, read-write, and super-user).

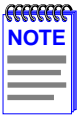

Super-User access gives the user full management privileges, allows existing passwords to be changed, and all modifiable MIB objects for the Cabletron Container MIB and Internet MIB-II to be edited.

Access the SNMP Community Names screen from the Chassis Menu screen by using the arrow keys to highlight the **SNMP COMMUNITY NAMES** menu item and pressing ENTER. The SNMP Community Names screen, [Figure 5-11](#), displays.

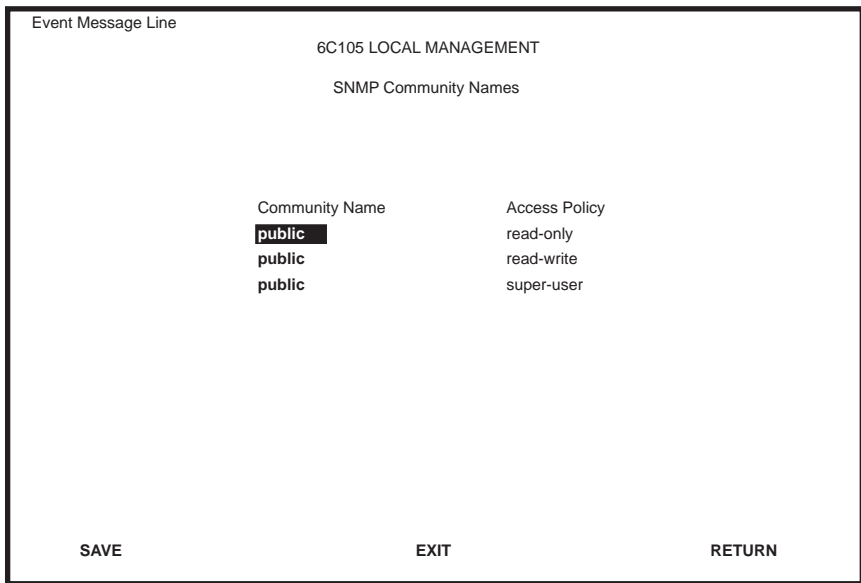

1960_97

Figure 5-11 SNMP Community Names Screen

The following explains each SNMP Community Names screen field:

Community Name (Modifiable)

Displays the user-defined name through which a user accesses 6C105 management. Any community name assigned here acts as a password to Local/Remote Management.

Access Policy (Read-Only)

Indicates the access accorded each community name. Possible selections are as follows:

read-only	This community name allows read-only access to the 6C105 MIB objects, and excludes access to security-protected fields of read-write or super-user authorization.
read-write	This community name allows read and write access to the 6C105 MIB objects, excluding security protected fields for super-user access only.
super-user	This community name permits read-write access to the 6C105 MIB objects and allows the user to change all modifiable parameters including community names, IP addresses, traps, and SNMP objects.

5.8.1 Establishing Community Names

The password used to access Local Management at the Password screen must have Super-User access in order to view and edit the SNMP Community Names screen. Using a password with read-only or read-write access does not allow the user to view or edit the SNMP Community Names screen.



Any community name assigned in the SNMP Community Names screen is a password to its corresponding level of access to Local Management. The community name assigned Super-User access is the only one that gives the user complete access to Local Management.

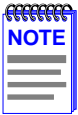

All passwords assigned in the 6C105 SNMP Community Names screen allow access to both 6C105 Local Management screens, and the Local Management screens of the interface modules that are installed in the chassis. To configure the interface module to not allow access to 6C105 Local Management screens refer to [Section 5.16](#).

To establish community names, proceed as follows:

1. Use the arrow keys to highlight the **Community Name** field adjacent to the selected access level.
2. Enter the password in the field (maximum 31 characters).
3. Press ENTER.
4. Repeat steps 1 through 3 to modify the other community names.
5. Use the arrow keys to highlight **SAVE** at the bottom of the screen and press ENTER. The message “SAVED OK” displays. The community names are saved to memory and their access modes implemented.

Enable Traps (Toggle)

Enables transmission of the traps to the network management station with the associated IP address. This field toggles between [YES] and [NO].

5.9.1 Configuring the Trap Table

To configure the Trap table, proceed as follows:

1. Using the arrow keys, highlight the appropriate **Trap Destination** field.
2. Enter the IP Address of the workstation that is to receive traps. IP address entries must follow the DDN format.

For example: 134.141.79.121
3. Press ENTER. If an invalid entry is entered “INVALID IP ENTERED” is displayed in the Event Message Line.
4. Using the arrow keys, highlight the **Trap Community Name** field. Enter the community name.
5. Press ENTER.
6. Using the arrow keys, highlight the **Enable Traps** field. Press the SPACE bar to choose either [YES] (send alarms from the chassis to the workstation), or [NO] (prevent alarms from being sent).
7. Using the arrow keys, highlight the **SAVE** command and press ENTER. The message “SAVED OK” displays on the screen.



Exiting without saving causes a “NOT SAVED?” message to appear above the **SAVE** command. Edits will be lost if they are not saved before exiting.

The designated workstations now receive traps from the 6C105.

5.10 CHASSIS ENVIRONMENTAL SCREEN

The Chassis Environmental menu item allows the user to view chassis environmental information.

Access the Chassis Environmental Information screen from the Chassis Menu screen by using the arrow keys to highlight the **CHASSIS ENVIRONMENTAL** menu item and pressing ENTER. The Chassis Environmental Information screen, [Figure 5-13](#), displays.

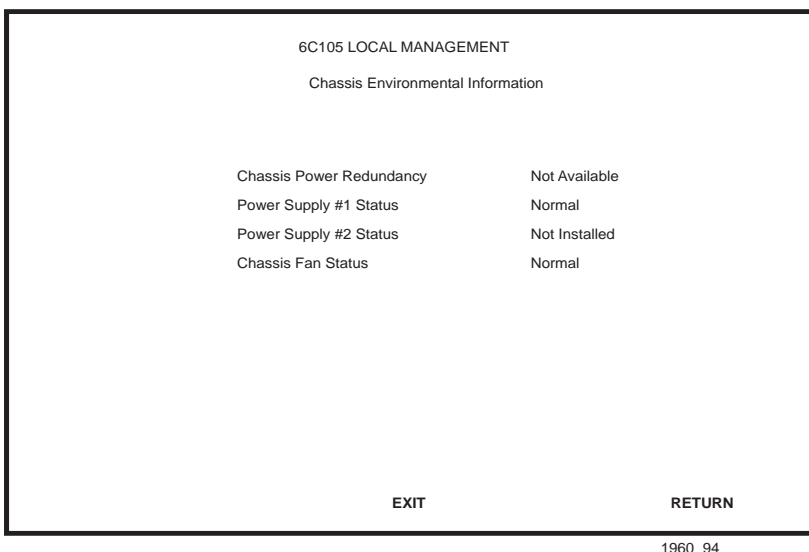

Figure 5-13 Chassis Environmental Information Screen

The following describes each of the Chassis Environmental Information screen fields.

Chassis Power Redundancy (Read-Only)

Displays the current redundancy status of the 6C105 power supplies. This field will read either “Available” or “Not Available”.

Power Supply #X Status (Read-Only)

Displays the current status of power supplies 1 and 2 for the 6C105. This field will read either “Normal”, “Fault”, or “Not Installed”.

Chassis Fan Status (Read-Only)

Displays the current status of the 6C105 fan tray. This field will read either “Normal”, “Fault”, or “Not Installed”.

5.11 PORT REDIRECT FUNCTION SCREEN

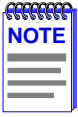

The Port Redirect Function screen may not be available depending on the operational mode that has been set for the chassis. Refer to your Release Notes to see what operational modes support the Port Redirect Function. Refer to [Section 5.7.7, Setting the Operational Mode](#), for instructions on configuring the operational mode of all the modules installed in the chassis.

The Port Redirect Function screen, [Figure 5-14](#), allows the user to set each one of the modules in the chassis (1 through 5), and the ports of the corresponding module installed, as a source or destination port. A port can be set to have one or more destination ports and chassis module slot numbers. For example, port 1 in module (slot) 1 can be set as a source port with three destinations, ports 2, 3, and 4 in module (slot) 3. Traffic from port 1 in module 1 is then automatically redirected to ports 2, 3, and 4 in module 3. Port 1 in module 1 can also serve as a destination port for other ports and modules. The port redirect function is extremely useful for troubleshooting purposes, as it allows traffic to be sent to a particular port(s) where, with the use of an analyzer or RMON probe, all current traffic from the source port(s) can be examined.

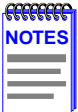

The module number corresponds to the slot number in which the module resides in the 6C105 chassis (1 through 5).

Although traffic from the source port (including, if desired, errored frames) is sent to the destination port, normal switching is still performed for all frames on the source port.

Access the Port Redirect Function screen from the Chassis Menu screen by using the arrow keys to highlight the **PORT REDIRECT FUNCTION** menu item and pressing ENTER. The Port Redirect Function screen, [Figure 5-14](#), displays.

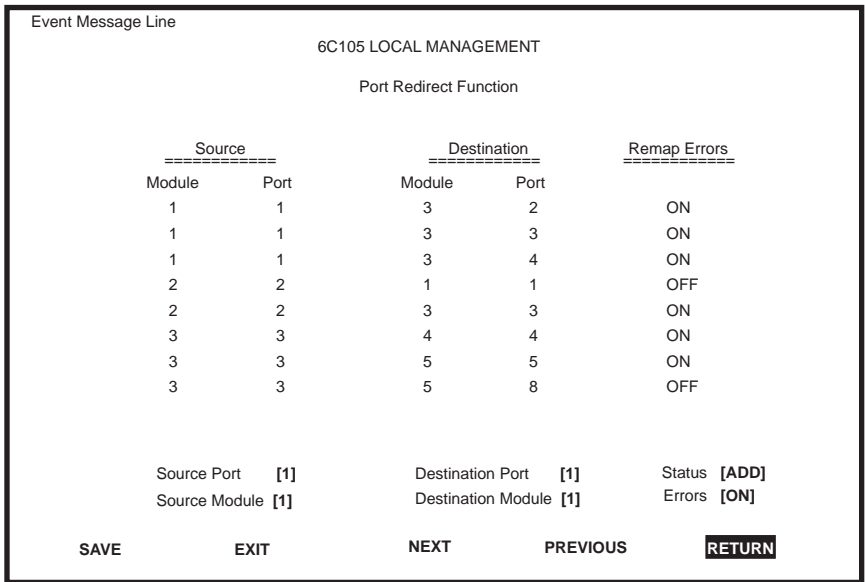

1960_66

Figure 5-14 Port Redirect Function Screen

The following definitions briefly explain each field of the Port Redirect Function screen.

Source Module (Read-Only)

Displays which modules are currently set as source modules.

Source Port (Read-Only)

Displays which ports are currently set as source ports.

Destination Module (Read-Only)

Displays which modules are currently set as destination modules.

Destination Port (Read-Only)

Displays which ports are currently set as destination ports.

Remap Errors (Read-only)

Displays whether the corresponding source modules and ports are configured to send errored frames to the destination modules and ports, or to drop all errored frames before forwarding traffic.

Source Module [n] (Selectable)

Allows a selected module [n] to be configured as a source module.

Source Port [n] (Selectable)

Allows a selected port [n] to be configured as a source port.

Destination Module [n] (Selectable)

Allows a selected module [n] to be configured as a destination module.

Destination Port [n] (Selectable)

Allows a selected port [n] to be configured as a destination port.

Errors (Toggle)

Allows the user to configure the source modules and ports to either send errored frames to selected destination modules and ports ([ON] option), or to drop errored frames, and send only valid traffic to the destination modules and ports ([OFF] option). The default setting of this field is [ON].

Status (Toggle)

Allows the user to add or delete the source/destination modules and ports selected in the Source/Destination Modules and ports fields.

5.11.1 Displaying the Source and Destination Entries

There can be more than one Port Redirect Function screen depending on the number of port redirect entries. Each screen displays up to ten port redirect entries. If there is more than one screen of redirect entries, the **NEXT** and/or **PREVIOUS** command is displayed at the bottom of the screen, allowing the user to navigate to the next or previous screen.

To display the next screen, use the arrow keys to highlight **NEXT**. Press **ENTER** and the next screen of entries is displayed.

To display the previous screen, use the arrow keys to highlight **PREVIOUS**. Press **ENTER** to view the entries in the previous screen.

5.11.2 Changing Source and Destination Ports

Add or delete source/destination module and port entries as follows:

1. Use the arrow keys to highlight the **Source Module** field.
2. Press the SPACE bar or BACKSPACE one or more times to increment or decrement the module number displayed in the brackets [*n*] until the appropriate module number is displayed.
3. Use the arrow keys to highlight the **Source Port** field.
4. Press the SPACE bar or BACKSPACE one or more times to increment or decrement the port number displayed in the brackets [*n*] until the appropriate port number is displayed.
5. Use the arrow keys to highlight the **Destination Module** field.
6. Use the SPACE bar or BACKSPACE to step to the appropriate module number for the destination module.
7. Use the arrow keys to highlight the **Destination Port** field.
8. Use the SPACE bar or BACKSPACE to step to the appropriate port number for the destination port.
9. Use the arrow keys to highlight the **Status** field.
10. Use the SPACE bar to select either the [ADD] or [DEL] (delete) option. Press ENTER. This adds or deletes the selections made in steps 2 and 4 and also updates the screen Source Module, Source Port, Destination Module and Destination Port lists.
11. Use the arrow keys to highlight the **Errors** field.
12. Use the SPACE bar to select either the [ON] or [OFF] option and press ENTER. [ON] forces the source module and port to forward errored frames to the destination module(s) and port(s). [OFF] forces the errored frames to be dropped before forwarding traffic.



If more than one module and port is to be redirected, repeat steps 1 through 12 for each additional setting, then go to step 13 to save all the new settings at once.

13. Use the arrow keys to highlight **SAVE** at the bottom of the screen. Press ENTER. The message “SAVED OK” is displayed.

5.12 MODULE SELECTION SCREEN

The Module Selection screen is the access point to Local Management for all modules installed in the SmartSwitch 6000 chassis. By selecting a module, the Module Menu for the selected device displays. Figure 5-15 shows the Module Selection screen.

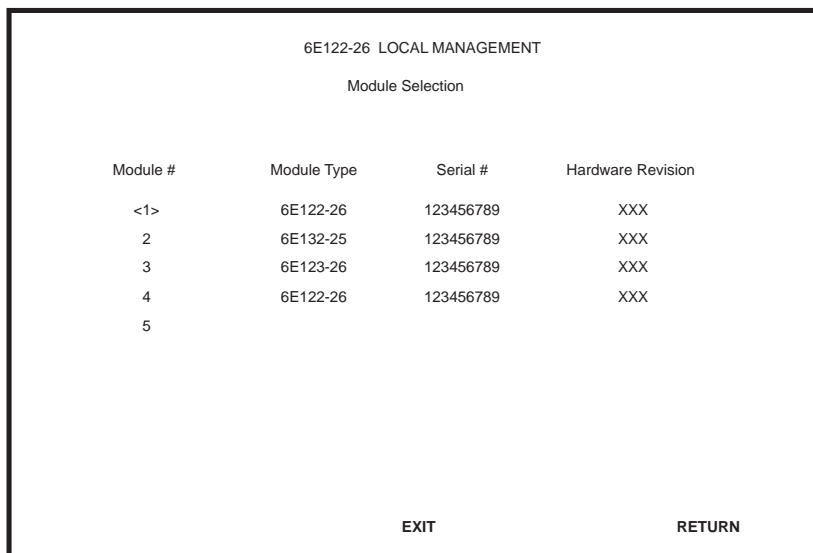

The screenshot shows a terminal window titled "6E122-26 LOCAL MANAGEMENT" with a sub-header "Module Selection". It contains a table with four columns: "Module #", "Module Type", "Serial #", and "Hardware Revision". The first row has "<1>" in the first column. Below the table are "EXIT" and "RETURN" options.

Module #	Module Type	Serial #	Hardware Revision
<1>	6E122-26	123456789	XXX
2	6E132-25	123456789	XXX
3	6E123-26	123456789	XXX
4	6E122-26	123456789	XXX
5			

EXIT RETURN

Figure 5-15 Module Selection Screen

The following explains each Module Selection screen field as shown in Figure 5-15.

Module

The Module # field displays the slot in which the module is installed. The module number enclosed in < > characters indicates the module to which the management terminal or Telnet session is connected.

Module Type

The Module Type field displays the type of interface module that is installed in each slot.

Serial

Indicates the serial number of the module. The serial number of the device is necessary when calling the Cabletron Systems Global Call Center.

Hardware Revision

Reflects the hardware version of the module.

5.12.1 Selecting a Module

To select an individual module to perform Local Management functions, proceed as follows:

1. Use the arrow keys to highlight the desired module number in the Module # field.
2. Press ENTER, the applicable Module Menu screen displays. Proceed to [Section 5.13](#).

5.13 MODULE MENU SCREEN



The Local Management screens shown in this chapter are for the 6E122-26. The 6E132-25, 6E133-25 and 6E123-26 share most of the following Local Management screens. All Local Management functions specific to any interface module are preceded by a note to alert the reader.

The 6E12X-26 and 6E13X-25 Module Menu screens are the access point for all Local Management screens for the 6E12X-26 and 6E13X-25.

Figure 5-16 shows the 6E122-26 Module Menu screen.

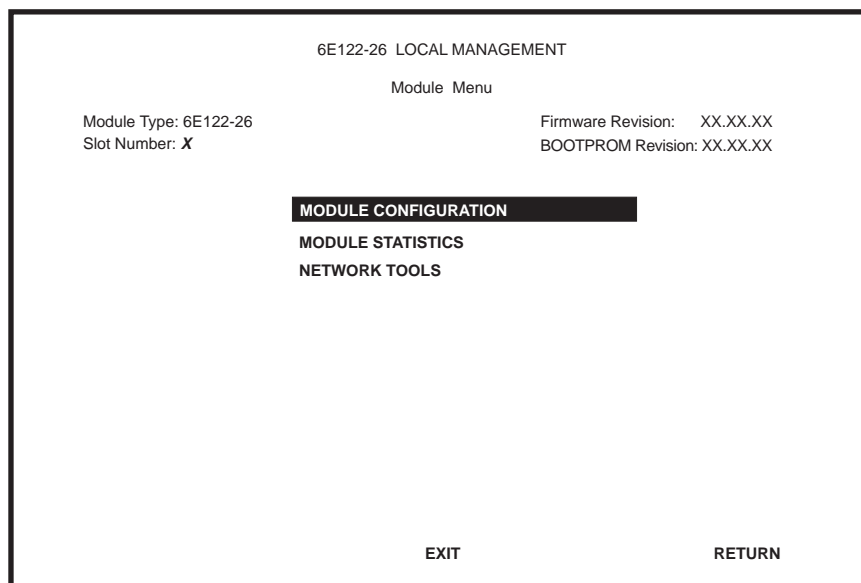

1960_13

Figure 5-16 Module Menu Screen

The following explains each Module Menu screen field as shown in [Figure 5-16](#):

MODULE CONFIGURATION

The Module Configuration screen provides access to the Local Management screens that are used to configure the 6E12X-26 and 6E13X-25. The Module Specific Configuration Menu screen provides access to the screens that allow the user to check 6E12X-26 and 6E13X-25 resources and set operating parameters specific to each port. For details about the Module Configuration Menu screen, refer to [Section 5.14](#). For details about the Module Specific Configuration Menu screen, refer to [Section 5.20](#).

MODULE STATISTICS

The Module Statistics screen provides statistics and performance information for the 6E12X-26 and 6E13X-25. For details about this screen, refer to [Section 5.26](#).

NETWORK TOOLS

The Network Tools function resides on the 6E12X-26 and 6E13X-25 and consists of a series of commands that allow the user to access and manage network devices. [Section 5.30](#) explains how to use the Network Tools utility.

5.14 MODULE CONFIGURATION MENU SCREEN

The Module Configuration Menu screen, [Figure 5-17](#), provides access to Local Management screens that allow you to configure and monitor operating parameters, modify SNMP community names, set SNMP traps, configure switch parameters and configure 6E12X-26 and 6E13X-25 ports.

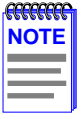

The following menu items on the Module Configuration Menu screen may not display if the operational mode of the module has been set to SECURE FAST VLAN:

SWITCH CONFIGURATION

SMARTTRUNK CONFIGURATION

Refer to your Release Notes to see if the functionality provided by the above screens is supported in SECURE FAST VLAN mode.

[Section 5.15.9](#) provides instructions on setting the operational mode.

Access the Module Configuration Menu screen from the Module Menu screen by using the arrow keys to highlight the **MODULE CONFIGURATION** menu item and pressing ENTER. The Module Configuration screen displays.

The following briefly explains each screen accessible from the Module Configuration Menu screen:

GENERAL CONFIGURATION

The General Configuration screen allows the user to monitor and configure operating parameters for the 6E12X-26 and 6E13X-25. For details, refer to [Section 5.15](#).

SNMP COMMUNITY NAMES

The SNMP Community Names screen allows the user to enter new, change, or review the community names used as access passwords for Local/Remote management operation. Access is limited based on the password level of the user. For details, refer to [Section 5.16](#).

SNMP TRAPS

The SNMP Traps screen provides display and configuration access to the table of IP addresses used for trap destinations and associated community names. For details, refer to [Section 5.17](#).

SWITCH CONFIGURATION

The Switch Configuration screen provides basic setup options for modifying the switching functions of the modules. For details, refer to [Section 5.18](#).

ETHERNET FULL DUPLEX CONFIGURATION

The Ethernet Full Duplex Configuration screen allows each 10 Mbps port (1 to 24) to be set for either Standard Ethernet or Full Duplex operation. The screen also indicates whether or not each port is linked to another Ethernet device and if that port is enabled. For details, refer to [Section 5.19](#).

SMARTTRUNK CONFIGURATION

The SmartTrunk Configuration screen allows the user to logically group interfaces together to create a greater bandwidth uplink. Refer to the Cabletron Systems *SmartTrunk User's Guide* for additional information.

MODULE SPECIFIC CONFIGURATION

The Module Specific Configuration Menu screen allows the user to configure ports or check system resources specific to the 6E12X-26 and 6E13X-25. For details, refer to [Section 5.20](#).

5.15 GENERAL CONFIGURATION SCREEN

The General Configuration screen, [Figure 5-18](#), allows the user to set the system date and time, IP address and subnet mask, the default gateway, the TFTP Gateway IP address, the Operational Mode, the Management Mode, and the COM port configuration. The General Configuration screen also allows the user to Clear NVRAM, and enable or disable IP Fragmentation.

Access the General Configuration screen from the Module Configuration Menu screen by using the arrow keys to highlight the **GENERAL CONFIGURATION** menu item and pressing ENTER. The General Configuration screen, [Figure 5-18](#), displays.

Event Message Line		
6E122-26 LOCAL MANAGEMENT		
General Configuration		
Module Type: 6E122-26	Firmware Revision: XX.XX.XX	
Slot Number: X	BOOTPROM Revision: XX.XX.XX	
MAC Address: 00-00-ID-00-00-00	Module Date: 10/11/97	
IP Address: 0.0.0.0	Module Time: 14:23:00	
Subnet Mask: 255.255.0.0	Screen Refresh Time: 30 sec.	
Default Gateway: NONE DEFINED	Screen Lockout Time: 15 min.	
TFTP Gateway IP Addr: 0.0.0.0	Module Uptime XX D XX H XX M	
Operational Mode: [802.1D SWITCHING]	Management Mode: [DISTRIBUTED]	
Com: [ENABLED]	Application: [LM]	
Clear NVRAM [NO]	IP Fragmentation [ENABLED]	
SAVE	EXIT	RETURN

1960_15

Figure 5-18 General Configuration Screen

The following briefly explains each General Configuration screen field:

MAC Address (Read-Only)

Displays the base physical address of the module.

IP Address (Modifiable)

This display allows the IP address to be set for the 6E12X-26 and 6E13X-25. To set the IP address, refer to [Section 5.15.1](#).

Subnet Mask (Modifiable)

Displays the subnet mask for the module. A subnet mask “masks out” the network bits of the IP address by setting the bits in the mask to 1 when the network treats the corresponding bits in the IP address as part of the network or subnetwork address, or to 0 if the corresponding bit identifies the host. When an IP address is entered in the IP Address field, the subnet mask field automatically enters the default subnet mask for the IP address. For details about how to change the subnet mask from its default value, refer to [Section 5.15.2](#).

Default Gateway (Modifiable)

Displays the default gateway for the 6E12X-26 and 6E13X-25. This field is not defined until an appropriate value is entered. For details about why and how to set the Default Gateway, refer to [Section 5.15.3](#).

TFTP Gateway IP Addr (Modifiable)

Displays and allows the user to set the TFTP Gateway IP address for the 6E12X-26 and 6E13X-25. To set the TFTP Gateway IP address, refer to [Section 5.15.4](#).

Module Date (Modifiable)

Contains a value that the module recognizes as the current date. To set a new module date, refer to [Section 5.15.5](#).

Module Time (Modifiable)

Contains a value that the module recognizes as the current time. To enter a new time, refer to [Section 5.15.6](#).

Screen Refresh Time (Modifiable)

Contains the rate at which the screens are updated. This setting determines how frequently (in seconds) information is updated on the screen. To enter a new update time, refer to [Section 5.15.7](#).

Screen Lockout Time (Modifiable)

Contains the maximum number of minutes that the Local Management application displays a module's screen while awaiting input or action from a user. For example, if the number 5 is entered in this field, the user has up to five minutes to respond to each of the specified module's Local Management screens. In this example, after five minutes of "idleness" (no input or action), the terminal "beeps" five times, the Local Management application terminates the session, and the display returns to the Password screen. To enter a new lockout time, refer to [Section 5.15.8](#).

Module Uptime (Read-Only)

Displays the total time that the module has been operating.

Operational Mode (Modifiable)

This field allows the user to set the 6E12X-26 and 6E13X-25 to operate as a traditional switch (802.1D SWITCHING option), an IEEE 802.1Q switch (802.1Q SWITCHING option), or as a Cabletron Systems SecureFast switch (SECURE FAST VLAN option).

In 802.1D SWITCHING mode, the 24 ports located on the front panel, and each Fast Ethernet Interface Module, and HSIM port(s) are bridged to each other.

In 802.1Q SWITCHING mode, the 6E12X-26 and 6E13X-25 are able to increase their switching functionality by creating and maintaining IEEE port based VLANs.

When the operational mode is set to SECURE FAST VLAN, the 6E12X-26 and 6E13X-25 act as SecureFast switches. With the Cabletron Systems VLAN Manager software, the modules are able to increase their switching functionality by creating and maintaining Virtual LANs (VLANs).

For details on how to select the Operational Mode, refer to [Section 5.15.9](#).

Management Mode (Toggle)

This field toggles between DISTRIBUTED and STAND ALONE.

In DISTRIBUTED mode, Local Management is entered via the 6C105 password screen, and all chassis configuration screens are available to the user. All other modules installed in the chassis that are set for distributed management may also be accessed via a connection to a single COM port on one of the modules.

In STAND ALONE mode, the module is isolated from the chassis configuration screens, and the module may not be accessed from a module that is in DISTRIBUTED mode. This provides additional security for any module to which the user may wish to restrict access. **Section 5.15.10** describes how to set the Management Mode.

Com (Toggle)

This field allows the user to enable or disable the COM port. The selection toggles between ENABLED and DISABLED. The default is ENABLED. For details about setting up the COM port, refer to **Section 5.15.11**.

Application (Modifiable)

Displays the application set for the COM port. This field allows you to set the application that the COM port will support, which includes:

- Local Management (LM) via a terminal or modem connection
- Uninterruptible Power Supply (UPS)

The UPS setting allows you to use the COM port to monitor an American Power Conversion Uninterruptible Power Supply (UPS). For UPS, the baud rate is automatically set to 2400.

The baud rate setting for LM is automatically sensed.

For details about how to configure the COM port for various applications, refer to **Section 5.15.11**.

Clear NVRAM (Toggle)

This allows the user to reset NVRAM to the factory default settings. All user-entered parameters, such as IP address and Community Names are then replaced with 6E12X-26 and 6E13X-25 default configuration settings. For details, refer to [Section 5.15.13](#).

IP Fragmentation (Toggle)

This field allows the user to enable or disable IP fragmentation. The default setting for this field is ENABLED. If the 6E12X-26 or 6E13X-25 will be bridged to an FDDI ring, IP Fragmentation should be enabled. If IP Fragmentation is disabled, all FDDI frames that exceed the maximum Ethernet frame size will be discarded. For details on enabling or disabling IP Fragmentation refer to [Section 5.15.14](#).

5.15.1 Setting the IP Address

To set the IP address, perform the following steps:



If the 6C105 chassis has been assigned an IP address, it is not necessary to assign an IP address to the 6E12X-26 and 6E13X-25. All installed modules have the same IP address as the chassis. If a separate IP address for the module is desired, proceed as follows.

1. Use the arrow keys to highlight the **IP Address** field.
2. Enter the IP address into this field using Decimal Dotted Notation (DDN) format.

For example: 134.141.79.120

3. Press ENTER. If the IP address is a valid format, the cursor returns to the beginning of the IP address field. If the entry is not valid, the Event Message Line displays "INVALID IP ADDRESS OR FORMAT ENTERED". Local Management does not alter the current value and refreshes the IP address field with the previous value.
4. Use the arrow keys to highlight the **SAVE** command, then press ENTER. The warning screen shown in [Figure 5-19](#) displays.

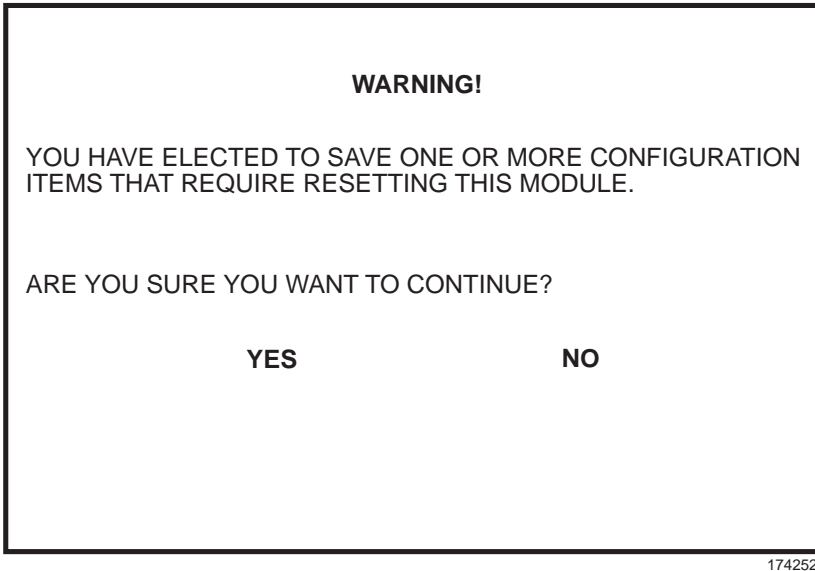

Figure 5-19 Configuration Warning Screen

5. Use the arrow keys to highlight the **YES** command and Press ENTER. The changes are saved and the module reboots.

5.15.2 Setting the Subnet Mask

If the management workstation that is to receive SNMP traps from the 6E12X-26 and 6E13X-25 is located on a separate subnet, the subnet mask for the 6E12X-26 and 6E13X-25 must be changed from its default.

To change the subnet mask from its default, perform the following steps:

1. Use the arrow keys to highlight the **Subnet Mask** field.
2. Enter the subnet mask into this field using Decimal Dotted Notation (DDN) format.

For example: 255.255.255.0

3. Press ENTER. If the subnet mask is valid, the cursor returns to the beginning of the Subnet Mask field. If the entry is not valid, the Event Message Line displays “INVALID SUBNET MASK OR FORMAT ENTERED”. Local Management does not alter the current value, but it does refresh the Subnet Mask field with the previous value.
4. Use the arrow keys to highlight the **SAVE** command, then press ENTER. The warning screen shown in [Figure 5-19](#) displays.
5. Use the arrow keys to highlight the **YES** command and press ENTER. The changes are saved and the module reboots

5.15.3 Setting the Default Gateway

If the SNMP management station is located on a different IP subnet than the 6E12X-26 and 6E13X-25, a default gateway must be specified. When an SNMP Trap is generated, the 6E12X-26 and 6E13X-25 sends the Trap to the default gateway. To set the default gateway, perform the following steps:

1. Use the arrow keys to highlight the **Default Gateway** field.
2. Enter the IP address of the default gateway using the DDN format.
For example: 134.141.79.121
3. Press ENTER. If the default gateway entered is a valid format, the cursor returns to the beginning of the Default Gateway field. If the entry is not valid, the Event Message Line displays “INVALID DEFAULT GATEWAY OR FORMAT ENTERED”. Local Management does not alter the current value, but it does refresh the Default Gateway field with the previous value.
4. Use the arrow keys to highlight the **SAVE** command.
5. Press ENTER. The Event Message Line at the top of the screen displays “SAVED OK”.

5.15.4 Setting the TFTP Gateway IP Address

If the network TFTP server is located on a different IP subnet than the 6E12X-26 and 6E13X-25, a Gateway IP address should be specified. To set the TFTP Gateway IP address, perform the following steps:

1. Use the arrow keys to highlight the **TFTP Gateway IP Address** field.
2. Enter the IP address of the TFTP gateway using the DDN format.

For example: 134.141.80.122

3. Press ENTER. If the TFTP gateway IP address entered is a valid format, the cursor returns to the beginning of the TFTP Gateway IP Address field. If the entry is not valid, the Event Message Line displays “INVALID TFTP GATEWAY IP ADDRESS OR FORMAT ENTERED”. Local Management does not alter the current value, but it does refresh the TFTP Gateway IP Address field with the previous value.
4. Use the arrow keys to highlight the **SAVE** command.
5. Press ENTER. The Event Message Line at the top of the screen displays “SAVED OK”.

5.15.5 Setting the Module Date

The modules are year 2000 compliant, so the module date may be set beyond the year 1999. To set the module date, perform the following steps:



If the 6C105 chassis has been assigned a chassis date, it is not necessary to assign a module date to the 6E12X-26 and 6E13X-25. All installed modules recognize the chassis date of the 6C105.

1. Use the arrow keys to highlight the **Module Date** field.
2. Enter the date in an MM/DD/YYYY format.



It is not necessary to add separators between month, day, and year numbers. For example, to set the date to 03/17/1997, type “03171997” in the Module Date field.

3. Press ENTER to set the system calendar to the date in the input field.
4. Use the arrow keys to highlight the **SAVE** command at the bottom of the screen and press ENTER.

If the date entered is a valid format, the Event Message Line at the top of the screen displays “SAVED OK”. If the entry is not valid, Local Management does not alter the current value, but it does refresh the Module Date field with the previous value.

5.15.6 Setting the Module Time

To set the module clock, perform the following steps:



If the 6C105 chassis has been assigned a chassis time, it is not necessary to assign a module time to the 6E12X-26 and 6E13X-25. All installed modules recognize the chassis time of the 6C105.

1. Use the arrow keys to highlight the **Module Time** field.
2. Enter the time in an 24-hour format, HH:MM:SS.

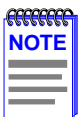

When entering the time in the system time field, separators between hours, minutes, and seconds do not need to be added as long as each entry uses two numeric characters. For example, to set the time to 6:45 A.M., type “064500” in the Module Time field.

3. Press ENTER to set the system clock to the time in the input field.
4. Use the arrow keys to highlight the **SAVE** command at the bottom of the screen and press ENTER.

If the time entered is a valid format, the Event Message Line at the top of the screen displays “SAVED OK”. If the entry is not valid, Local Management does not alter the current value and refreshes the Module Time field with the previous value.

5.15.7 Entering a New Screen Refresh Time

The screen refresh time is set from 3 to 99 seconds with a default of 3 seconds. To set a new screen refresh time, perform the following steps:

- 1.** Use the arrow keys to highlight the **Screen Refresh Time** field.
- 2.** Enter a number from 3 to 99.
- 3.** Press ENTER to set the refresh time to the time entered in the input field.
- 4.** Use the arrow keys to highlight the **SAVE** command at the bottom of the screen and press ENTER.

If the time entered is within the 3 to 99 seconds range, the Event Message Line at the top of the screen displays “SAVED OK”. If the entry is not valid, Local Management does not alter the current setting, but it does refresh the Screen Refresh Time field with the previous value.

5.15.8 Setting the Screen Lockout Time

The screen lockout time can be set from 1 to 30 minutes with a default of 15 minutes. To set a new lockout time, perform the following steps:

- 1.** Use the arrow keys to highlight the **Screen Lockout Time** field.
- 2.** Enter a number from 1 to 30.
- 3.** Press ENTER to set the lockout time in the input field.
- 4.** Use the arrow keys to highlight the **SAVE** command at the bottom of the screen and press ENTER.

If the time entered is within the 1 to 30 minutes range, the Event Message Line at the top of the screen displays “SAVED OK”. If the entry is not valid, Local Management does not alter the current setting, but it does refresh the Screen Lockout Time field with the previous value.

5.15.9 Setting the Operational Mode



Before setting the operational mode, ensure that the items contained in this caution are fully understood.

If the module will be configured to operate as a SecureFast switch the following procedures should be performed before setting the operational mode:

The module must be assigned a unique IP address.

The Management Mode of the module will automatically be set to STANDALONE. The Management Mode field will no longer display on the General Configuration screen, and the module will no longer support Chassis configuration and Module selection screens. If the module will be a SecureFast switch, distributed management is not allowed.

The module has been assigned SNMP community names from the module SNMP Community Names screen (Section 5.16). In Standalone management mode, the module does not use the community names of the 6C105 chassis.

To set the Operational Mode, proceed as follows:

1. Use arrow keys to highlight the **Operational Mode** field.
2. Press the SPACE bar to step to the appropriate operation mode, (**802.1D SWITCHING**, **802.1Q SWITCHING**, or **SECURE FAST VLAN**).
3. Use the arrow keys to highlight the **SAVE** command, then press ENTER. The warning screen shown in Figure 5-19 displays.
4. Use the arrow keys to highlight the **YES** command and press ENTER. The changes are saved and the module reboots.

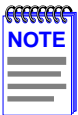

Upon saving the new operational mode, the module will reboot.

If the 6E12X-26 and 6E13X-25 have been set to **802.1Q SWITCHING**, refer to your *Port Based VLAN User's Guide* to configure the devices for this type of operation.

If the 6E12X-26 and 6E13X-25 have been set to **SECURE FAST VLAN**, refer to your SecureFast documentation set to configure the devices for this type of operation.

5.15.10 Setting the Management Mode

To set the management mode, perform the following steps:

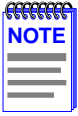

Upon saving the new Management Mode, the module will reboot.

If the module will be set to **STANDALONE**, ensure the following procedures have been completed:

The module has been assigned a unique IP address.

The module has been assigned SNMP community names from the module SNMP Community Names screen ([Section 5.16](#)). In **STAND ALONE** management mode, the module does not use the community names of the 6C105 chassis.

1. Use the arrow keys to highlight the Management Mode field:
2. Use the SPACE bar to toggle the options (**DISTRIBUTED** or **STAND ALONE**) until the desired mode displays.
3. Use the arrow keys to highlight the **SAVE** command, then press ENTER. The warning screen shown in [Figure 5-19](#) displays.
4. Use the arrow keys to highlight the **YES** command and press ENTER. The changes are saved and the module reboots.

5.15.11 Configuring the COM Port



Before altering the COM port settings, ensure that a valid IP address is set for the module or chassis. (Refer to [Section 5.15.1, Setting the IP Address](#).) Read this entire COM port configuration section before changing the settings of the COM port.

The 6E12X-26 and 6E13X-25 COM ports support the following applications:

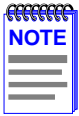

Refer to the Release Notes included with the 6E12X-26 and 6E13X-25 to verify which COM Port applications are currently supported.

- Local Management connections
- American Power Conversion Uninterruptible Power Supply (UPS) connections

To configure the COM port, proceed as follows:

1. Use the arrow keys to highlight the **Com** field.



Do **NOT** disable or alter the settings of the COM port while operating the current Local Management connection through a terminal. Altering the COM port settings disconnects the Local Management terminal from the port, and ends the Local Management session.

2. Press the SPACE bar to choose either **ENABLED** or **DISABLED**. The COM port must be **ENABLED** if it will be used for Local Management or UPS applications. Select **DISABLED** if you wish to disable the COM port for additional module security.



If the COM port is reconfigured without a valid IP address set on the module or chassis, the message shown in [Figure 5-20](#) displays. Do not continue unless the outcome of the action is fully understood.

5.15.12 Changing the Com Port Application

After enabling the COM port as described in [Section 5.15.11](#), you can select one of the applications supported by the COM port: LM, and UPS. The default application is LM.

To change the COM port application:

1. Use the arrows keys to highlight the **Application** field.
2. Use the SPACE bar or BACKSPACE to step through the available settings until the operation you require appears. [Table 5-3](#) lists the available settings and their corresponding applications.

Table 5-3. COM Port Application Settings

Setting	Application
LM	Local Management Session
UPS	APC Power Supply SNMP Proxy

3. Press ENTER to accept the application.
4. Use the arrow keys to highlight **SAVE** at the bottom of the screen, then press the ENTER key.
5. When the message “SAVED OK” appears, the edits you made are saved.



When the COM port is configured to perform the UPS application, all future Local Management connections must be made by establishing a Telnet connection to the module. Ensure that the module has a valid IP address before saving changes to the COM port application. If the module does not have a valid IP address and the changes are saved, refer to [Appendix C](#) for instructions on clearing NVRAM in order to reestablish COM port communications.

5.15.13 Clearing NVRAM



Clearing NVRAM will result in the loss of all user-entered parameters. Do not proceed unless this procedure is completely understood.

Clearing NVRAM allows the user to clear all user-entered parameters, such as IP address and Community Names from NVRAM.

Clear NVRAM as follows:

1. Use the arrow keys to highlight the **Clear NVRAM** field.
2. Use the SPACE bar to toggle the field to **YES**.
3. Use the arrow keys to highlight **SAVE** at the bottom of the screen.
4. Press ENTER. The warning shown in [Figure 5-21](#) is displayed.

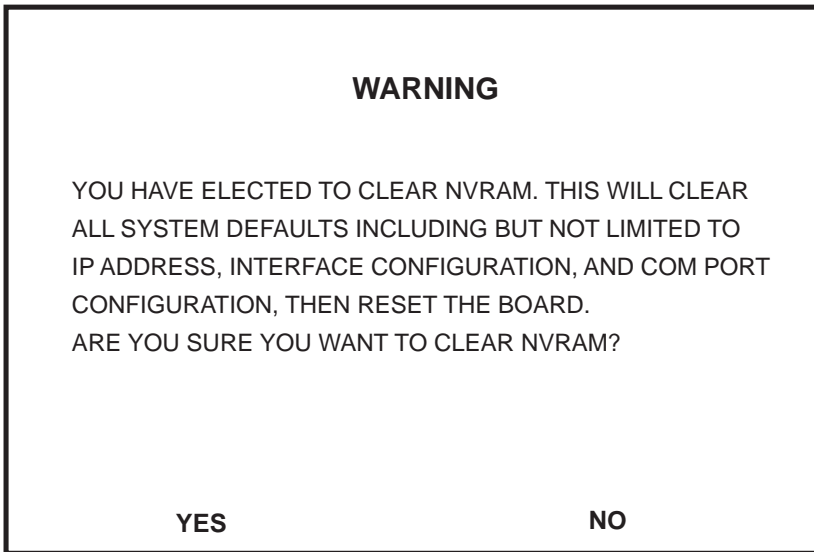

174251

Figure 5-21 Clear NVRAM Warning Screen

5. Use the arrow keys to highlight **YES** and press ENTER. The message “CLEARING NVRAM. REBOOT IN PROGRESS...” displays.

The 6E12X-26 and 6E13X-25 clear NVRAM and reboot. All user-entered parameters default to factory settings.

5.15.14 Enabling/Disabling IP Fragmentation

To enable or disable IP fragmentation, proceed as follows:

1. Use the arrow keys to highlight the **IP Fragmentation** field.
2. Press the SPACE bar to choose either **ENABLED** or **DISABLED**.
3. Use the arrow keys to highlight the **SAVE** command.
4. Press ENTER. The Event Message Line at the top of the screen displays “SAVED OK”.



If the 6E12X-26 and 6E13X-25 are being bridged to an FDDI ring (for example, via an HSI-M-F6 installed in the 6E13X-25) IP Fragmentation should be enabled. If IP Fragmentation is disabled, all FDDI frames that exceed the maximum Ethernet frame size will be discarded.

5.16 SNMP COMMUNITY NAMES SCREEN

The SNMP Community Names menu item allows the user to set Local/Remote Management community names. Community names act as passwords to Local/Remote Management and are agents of security access to the 6E12X-26 and 6E13X-25. Access to the 6E12X-26 and 6E13X-25 is controlled by enacting any of three different levels of security authorization (read-only, read-write, and super-user).



If the 6C105 has been assigned community names, it is not necessary to assign community names to the individual modules installed in the chassis unless the user wishes to limit access to 6C105 chassis screens by assigning different community names to the module. When this is done access is limited to the screens specific to the module to which the terminal is attached and the Local Management session begins at the Module Menu screen.

Super-User access gives the user full management privileges, allows existing passwords to be changed, and all modifiable MIB objects for the Cabletron Container MIB and Internet MIB-II to be accessed.

Access the SNMP Community Names screen from the Module Configuration Menu screen by using the arrow keys to highlight the **SNMP COMMUNITY NAMES** menu item and pressing ENTER. The SNMP Community Names screen, **Figure 5-22**, displays.

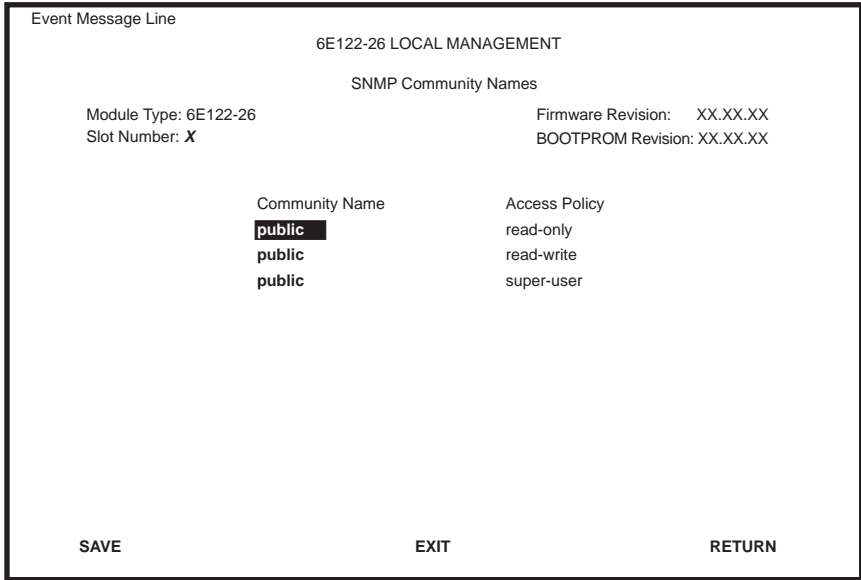

Figure 5-22 SNMP Community Names Screen

The following explains each SNMP Community Names screen field:

Community Name (Modifiable)

Displays the user-defined name through which a user accesses 6E12X-26 and 6E13X-25 management. Any community name assigned here acts as a password to Local/Remote Management.

Access Policy (Read-Only)

Indicates the access accorded each community name. Possible selections are as follows:

- read-only This community name allows read-only access to the 6E12X-26 and 6E13X-25 MIB objects, and excludes access to security-protected fields of read-write or super-user authorization.

read-write	This community name allows read and write access to the 6E12X-26 and 6E13X-25 MIB objects, excluding security protected fields for super-user access only.
super-user	This community name permits read-write access to the 6E12X-26 and 6E13X-25 MIB objects and allows the user to change all modifiable parameters including community names, IP addresses, traps, and SNMP objects.

5.16.1 Establishing Community Names

The password used to access Local Management at the Password Screen must have Super-User access in order to view and edit the SNMP Community Names screen. Using a password with read-only or read-write access does not allow the user to view or edit the SNMP Community Names screen.



Any community name assigned in the SNMP Community Names screen is a password to its corresponding level of access to Local/Remote Management. The community name assigned Super-User access is the only one that gives the user complete access to Local/Remote Management.

To establish community names, proceed as follows:

1. Use the arrow keys to highlight the **Community Name** field adjacent to the selected access level.
2. Enter the password in the field (maximum 31 characters).
3. Press ENTER.
4. Repeat steps 1 through 3 to modify the other community names.
5. Use the arrow keys to highlight **SAVE** at the bottom of the screen and press ENTER. The message “SAVED OK” displays. The community names are saved to memory and their access modes implemented.

5.17 SNMP TRAPS SCREEN

Since the 6E12X-26 and 6E13X-25 are SNMP compliant devices, they can send messages to multiple Network Management Stations to alert users of status changes. The SNMP Traps screen is shown in Figure 5-23.

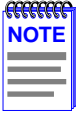

It is only necessary to assign SNMP traps if the user desires the traps to be sent to different addresses than those assigned in Section 5.9, which details how to set SNMP Traps for the 6C105 chassis.

Access the SNMP Traps screen from the Module Configuration Menu screen by using the arrow keys to highlight the **SNMP TRAPS** field and pressing ENTER. The SNMP Traps screen displays.

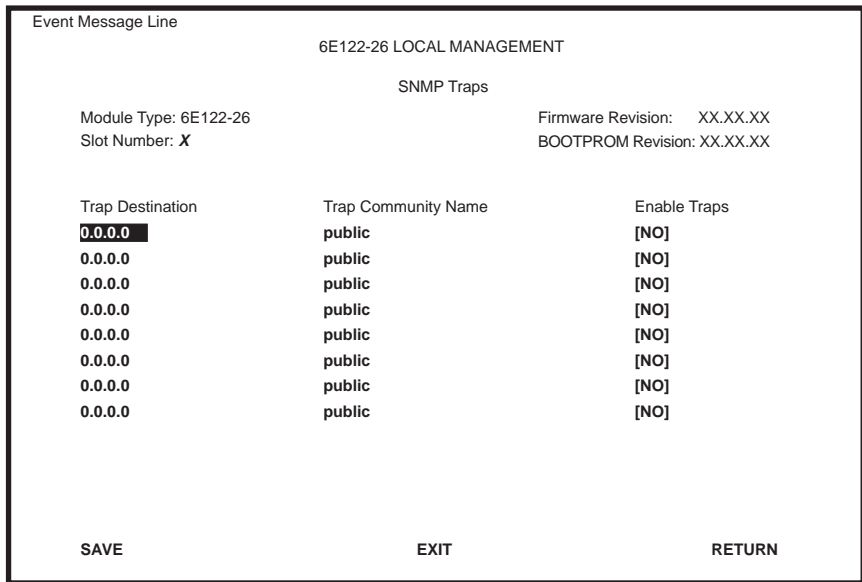

1960_17

Figure 5-23 SNMP Traps Screen

The following explains each field of the SNMP Traps screen.

Trap Destination (Modifiable)

Indicates the IP address of the workstation to receive trap alarms. Up to eight different destinations can be defined.

Trap Community Name (Modifiable)

Displays the Community Name included in the trap message sent to the Network Management Station with the associated IP address.

Enable Traps (Toggle)

Enables transmission of the traps to the network management station with the associated IP address. This field toggles between YES and NO.

5.17.1 Configuring the Trap Table

To configure the Trap Table, proceed as follows:

1. Using the arrow keys, highlight the appropriate **Trap Destination** field.
2. Enter the IP Address of the workstation that is to receive traps. IP address entries must follow the DDN format.

For example: 134.141.79.121
3. Press ENTER. If an invalid entry is entered “INVALID IP ENTERED” is displayed in the Event Message Line.
4. Using the arrow keys, highlight the **Trap Community Name** field. Enter the community name.
5. Press ENTER.
6. Using the arrow keys, highlight the **Enable Traps** field. Press the SPACE bar to choose either **YES** (send alarms from the module to the workstation), or **NO** (prevent alarms from being sent).
7. Using the arrow keys, highlight the **SAVE** option and press ENTER. The message “SAVED OK” displays on the screen.

The designated workstations now receive traps from the 6E12X-26 and 6E13X-25.

5.18 SWITCH CONFIGURATION SCREEN

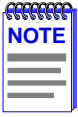

The Switch Configuration screen will not be available if the operational mode of the module has been set to SECURE FAST VLAN. This screen may only be used by modules configured to operate as traditional or 802.1Q switches.

The Switch Configuration screen, [Figure 5-24](#), provides the basic setup options to make a switch operational in your network.

Access the Switch Configuration screen from the Module Configuration Menu screen by using the arrow keys to highlight the **SWITCH CONFIGURATION** field and pressing ENTER. The Switch Configuration screen, [Figure 5-24](#), displays ports 1 through 8. To view or edit the fields for ports 9 to 16, highlight **[9-16]** at the bottom of the screen and press the ENTER key. Perform the function again to view or edit ports 17 to 24, and once again to view or edit ports 25 to 30.

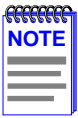

Ports 25 and 26 on the Switch Configuration screen represent the optional Fast Ethernet Interface Modules available for the 6E12X-26.

Port 25 on the Switch Configuration screen represents the optional HSIM available for the 6E13X-25.

Ports 27 through 30 (6E12X-26) or 26 through 29 (6E13X-25) on the Switch Configuration screen represent the backplane connections that the module has with the 6C105 chassis. The module has a direct connection to every other slot in the chassis.

```

Event Message Line

                                6E122-26 LOCAL MANAGEMENT

                                Switch Configuration

Module Type: 6E122-26                               Firmware Revision: XX.XX.XX
Slot Number: X                                       BOOTPROM Revision: XX.XX.XX

Switch Address: 00-00-1D-00-00-00                 Type of STA: [DEC]
Number of Ports: 30                               Age Time: 300

Port #      MAC Address      State      Status
-----
1           00-00-1D-00-00-00  learning  [ENABLED]
2           00-00-1D-00-00-01  listening [DISABLED]
3           00-00-1D-00-00-02  standby   [ENABLED]
4           00-00-1D-00-00-03  learning  [DISABLED]
5           00-00-1D-00-00-04  listening [ENABLED]
6           00-00-1D-00-00-05  standby   [DISABLED]
7           00-00-1D-00-00-06  listening [ENABLED]
8           00-00-1D-00-00-07  listening [DISABLED]

SAVE                EXIT          [9-16]                RETURN
    
```

Figure 5-24 Switch Configuration Screen

The following describe each field of the Switch Configuration screen:

Switch Address (Read-Only)

Displays the base MAC address of the switch.

Number of Ports (Read-Only)

Displays the total number of switched ports on the module.

Type of STA (Toggle)

Allows the user to set the method that switches use to decide which switch is the controlling (Root) switch when two or more switches exist in parallel (Spanning Tree Algorithm). Valid entries include **IEEE**, **DEC**, and **NONE**. To set the STA, refer to [Section 5.18.1](#).

Age Time (Modifiable)

Allows the user to set the amount of time (in seconds) the 6E12X-26 and 6E13X-25 will keep an address in its switch table before discarding it. The modules will discard an address from their switch table if they do not receive a valid packet from the applicable address in the amount of time specified in the Age Time field. To change the Age Time field from the default value of 300 seconds, refer to [Section 5.18.2](#).

Port # (Read-Only)

Lists each switch port on the module. If the number of ports is greater than eight, then the additional ports are listed on subsequent screens.

MAC Address (Read-Only)

Displays the hardware address assigned to each listed port.

State (Read-Only)

Disabled: Management disabled this interface. No traffic is received or forwarded while the interface is disabled.

Listening: The switch is not adding information to the Transparent Database. The switch is monitoring BPDU traffic while preparing to move from the learning to the forwarding state.

Learning: The switch is learning the network address of this interface. The switch enters the learning state when the Transparent Database is created (during start-up or after being deleted), or when the Spanning Tree Algorithm detects a network topology change.

Forwarding: The switch is on line and this interface is forwarding traffic.

Standby: This interface will not forward any traffic through the switch because a loop condition has been detected by the STA.

Status (Toggle)

Allows the user to disable or enable a port by setting the status of the listed interface to either ENABLED or DISABLED. To set the port status, refer to [Section 5.18.3](#).

5.18.1 Setting the STA

The Spanning Tree Algorithm (STA) setting allows the user to set the method that the switches use to decide which is the controller (Root) switch when two or more switches are in parallel. The available selections are **IEEE**, **DEC**, and **NONE**.

To set the STA, proceed as follows:

1. Use the arrow keys to highlight the **Type of STA** field.
2. Use the SPACE bar to step to the appropriate setting (**IEEE**, **DEC**, or **NONE**).

3. Use the arrow keys to highlight the **SAVE** command at the bottom of the screen.
4. Press ENTER. The message “SAVED OK” is displayed.

5.18.2 Setting the Age Time

To set the Age Time, proceed as follows:

1. Use the arrow keys to highlight the **Age Time** field.
2. Enter the desired Age Time in increments of 10. The available Age Time range is 10 seconds to 1,000,000 seconds with the default value being 300 seconds.
3. Use the arrow keys to highlight the **SAVE** command at the bottom of the screen.
4. Press ENTER. The message “SAVED OK” is displayed.

5.18.3 Setting (Enabling or Disabling) the Port Status

To set the status of an interface (port), proceed as follows:



Disabling the port status of a backplane connection will block the module from passing user traffic to the applicable module slot in the 6C105 chassis. SNMP and other management traffic (e.g., ping and Telnet traffic), however, will still pass via the backplane to the applicable module slot.

1. Use the arrow keys to highlight the **Status** field of the port.
2. Use the SPACE bar to toggle to either **ENABLED** or **DISABLED**.
3. Use the arrow keys to highlight the **SAVE** command at the bottom of the screen.
4. Press ENTER. The message “SAVED OK” is displayed.

5.19 ETHERNET FULL DUPLEX CONFIGURATION SCREEN

The Ethernet Full Duplex Configuration screen, [Figure 5-25](#), allows the user to set ports 1 through 24 for either Standard Ethernet or Full Duplex operation and monitor each port to see whether or not it is enabled and linked to another device.

Access the Ethernet Full Duplex Configuration screen from the Module Specific Configuration Menu screen by using the arrow keys to highlight the **ETHERNET FULL DUPLEX CONFIGURATION** menu item in the Module Specific Configuration Menu screen and press ENTER. The Ethernet Full Duplex Configuration screen, [Figure 5-25](#), displays.

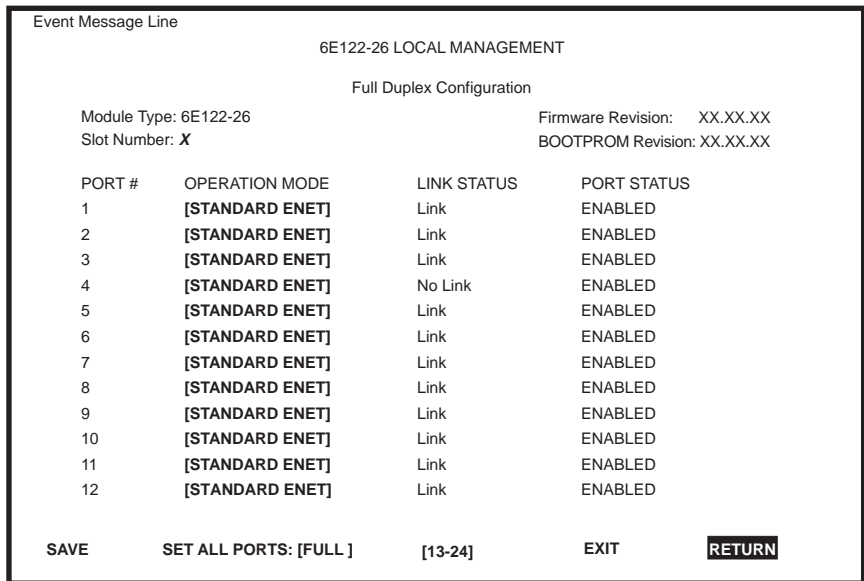

1960_21

Figure 5-25 Ethernet Full Duplex Configuration Screen

The following section explains each field of the Ethernet Full Duplex Configuration screen.

PORT # (Read-only)

Identifies the number of the port.

OPERATION MODE (Toggle)

Allows the user to set the specified port to transmit and receive data separately or simultaneously. Set this field to one of the following values:

- **STANDARD ENET** – The port is running at 10 Mbps (default) and either transmits data or receives data, but not both at the same time. To set Ethernet ports for Full Duplex operation, refer to [Section 5.19.1](#).
- **FULL DUPLEX** – The port transmits and receives data at the same time (full duplex) and operates at 20 Mbps. To set Ethernet ports for Full Duplex operation, refer to [Section 5.19.1](#).

LINK STATUS (Read-only)

Indicates whether there is a physical connection from this port to another Ethernet device. One of the following values displays:

- **Link** – There is a valid link signal present; there is a valid physical connection from this port to another device.
- **No Link** – There is no valid link signal present; there is no valid physical connection from this port to another device.

PORT STATUS (Read-only)

Indicates whether the port was turned on or off administratively. One of the following values is displayed:

- **ENABLED** – The port is turned on administratively.
- **DISABLED** – The port is turned off administratively.



Enabling or disabling ports from the Switch Configuration screen is described in [Section 5.18.3](#).

SET ALL PORTS (Toggle)

Ports 1 through 24 can be set all at once to either STANDARD or FULL from this field. To set all ports, refer to [Section 5.19.1](#).

[1-12], or [13-24] (Navigation Key)

When the Full Duplex Configuration screen displays, the current operation mode and status information are displayed for the first 12 ports. This field allows the user to step to a second screen for the same type of information for ports 13 through 24. While on the second screen, the user can navigate back to the first screen by selecting the **[1-12]** option. The user can change the Operation Mode fields while in either the first or second screen.

5.19.1 Setting the Operation Mode

The Operation Mode may be set to Standard Ethernet or Full Duplex either one port at a time or all at once. The following steps describe setting the port Operation Mode for individual ports followed by steps to set the Operation Mode for all ports.

Set the Operation Mode for individual ports as follows:

1. Use the arrow keys to highlight the **OPERATION MODE** field adjacent to the number of the port that you plan to change.



The Operation Mode for the first 12 ports can be changed on the first screen. To display the Operation Mode for Ports 13 through 24, use the arrow keys to highlight the Ports **[13-24]** field and press ENTER. To again display the Operation Mode for Ports 1 through 12, use the arrow keys to highlight the Ports **[1-12]** field and press ENTER.

2. Press the SPACE bar until the appropriate mode (**FULL DUPLEX** or **STANDARD ENET**) is displayed.
3. Use the arrow keys to highlight the **SAVE** command on the bottom line of the screen.
4. Press ENTER. The message “SAVED OK” is displayed.

To set all 24 Ethernet ports for Full Duplex or Standard Ethernet, proceed as follows:

1. Use the arrow keys to highlight the **SET ALL PORTS** field.
2. Press the SPACE bar until you see **FULL** or **STANDARD**.
3. Use the arrow keys to highlight the **SAVE** command on the bottom line of the screen.
4. Press ENTER. The message “SAVED OK” is displayed.

5.20 MODULE SPECIFIC CONFIGURATION MENU SCREEN

The Module Specific Configuration Menu screen, [Figure 5-26](#), allows the user to select one of five screens to configure ports or check system resources specific to the 6E12X-26 and 6E13X-25.



The following menu items on the Module Specific Configuration Menu screen may not display if the operational mode of the module has been set to SECURE FAST VLAN or 802.1Q SWITCHING:

PORT REDIRECT FUNCTION

BROADCAST SUPPRESSION

Refer to your Release Notes to see if the functionality provided by the above screens is supported.

[Section 5.15.9](#) provides instructions on setting the operational mode.

Access the Module Specific Configuration Menu screen from the Module Configuration Menu screen by using the arrow keys to highlight the **MODULE SPECIFIC CONFIGURATION MENU** menu item and pressing ENTER. The Module Specific Configuration Menu screen displays.

FLASH DOWNLOAD

The FLASH Download screen allows the user to force the 6E12X-26 and 6E13X-25 to download a new image file to FLASH memory from a TFTP server. For details, refer to [Section 5.23](#).

PORT REDIRECT FUNCTION

The Port Redirect Function screen allows the user to redirect traffic from one or more ports on the module to a specific destination port on the module. For details, refer to [Section 5.24](#).

[Section 5.15.9, Setting the Operational Mode](#), describes how to configure the modules to function as 802.1D switches.

BROADCAST SUPPRESSION

The Broadcast Suppression screen allows the user to set a desired limit of receive broadcast frames per port per second. For details, refer to [Section 5.25](#).

802.1Q VLAN Configuration

This menu item will only display if the module has been configured to operate as an IEEE 802.1Q switch and the Management Mode has been set to STAND ALONE. When selected, this menu item opens the VLAN Main Menu screen. For details, refer to the Cabletron Systems *Port Based VLAN User's Guide*. [Section 5.15.9, Setting the Operational Mode](#), describes how to configure the modules to function as 802.1Q switches. [Section 5.15.10, Setting the Management Mode](#), describes how to set the module to STAND ALONE management mode.



The module does not have to be in STAND ALONE mode to operate as an 802.1Q switch. In DISTRIBUTED management mode, 802.1Q VLANs are created and maintained via the 802.1Q VLAN CONFIGURATION menu item on the Chassis Menu screen. Refer to [Section 5.6](#) for details.

5.21 SYSTEM RESOURCES SCREEN

The System Resources screen, [Figure 5-27](#), provides information concerning the processor, the amount of FLASH memory, DRAM, and NVRAM that is installed and how much of that memory is available.

Access the System Resources screen from the Module Specific Configuration Menu screen by using the arrow keys to highlight the **SYSTEM RESOURCES** menu item and pressing ENTER. The System Resources screen displays.

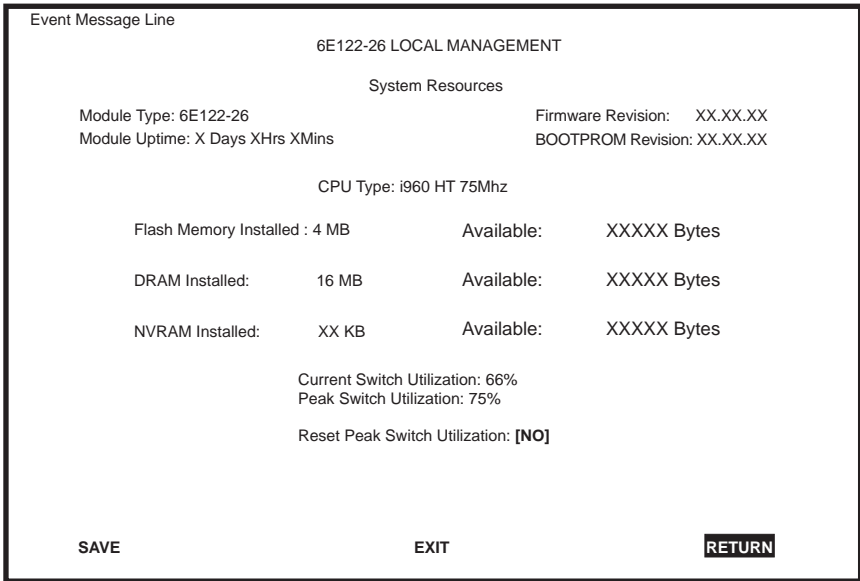

1960_23

Figure 5-27 System Resources Screen

The following briefly explains each field of the System Resources screen.

Module Uptime (Read-only)

The time in days/hours/minutes that the module has been continuously running.

CPU Type (Read-only)

Indicates the microprocessor used in the 6E12X-26 and 6E13X-25.

Flash Memory Installed (Read-only)

Indicates the amount of FLASH memory installed in the 6E12X-26 and 6E13X-25 and how much is currently available.

DRAM Installed (Read-only)

Indicates the amount of DRAM installed in the 6E12X-26 and 6E13X-25 and how much of it is currently available.

NVRAM Installed (Read-only)

Indicates the amount of NVRAM installed in the 6E12X-26 and 6E13X-25 and how much of it is currently available.

Current Switch Utilization (Read-only)

Shows how much (percentage of capacity) the 6E12X-26 and 6E13X-25 is currently being used.

Peak Switch Utilization (Read-only)

Shows the peak percentage of maximum switching capacity, since last reset.

Reset Peak Switch Utilization (Toggle)

Allows the user to reset the Peak Switch Utilization field. The switch may be set to either YES or NO as described in [Section 5.21.1](#). YES resets the Peak Switch Utilization field to the current system traffic.

5.21.1 Setting the Reset Peak Utilization

To set the Reset Peak Utilization field to **YES** or **NO**, proceed as follows:

1. Use the arrow keys to highlight the **Peak Switch Utilization** field.
2. Press the SPACE bar to select **YES** or **NO**.
3. Use the arrows keys to highlight the **SAVE** command at the bottom of the screen.
4. Press ENTER. The message “SAVED OK” is displayed.

5.22 HIGH SPEED INTERFACE CONFIGURATION MENU SCREEN (6E12X-26 ONLY)

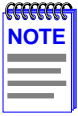

When the **HIGH SPEED CONFIGURATION MENU** is selected for the 6E13X-25 the applicable HSIM Setup screen displays. Refer to the HSIM User's Guide to set operating parameters for the HSIM installed in the 6E13X-25.

Access the High Speed Interface Configuration Menu screen from the Module Specific Configuration Menu screen by using the arrow keys to highlight the **HIGH SPEED INTERFACE CONFIGURATION MENU** menu item and pressing ENTER. The High Speed Interface Configuration screen displays.

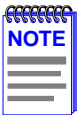

The High Speed Interface Configuration screen, [Figure 5-28](#), applies only to ports 25 and 26 of the 6E12X-26. This screen supports the FE-100TX, FE-100FX and FE-100F3 Fast Ethernet Interface Modules that operate at 100 Mbps. If you are configuring a 6E13X-25, refer to the applicable HSIM User's Guide, or proceed to [Section 5.23](#).

The High Speed Interface Configuration screen displays the types of interfaces installed in ports 25 and 26, their current operating mode, and indicates if the ports are linked. This screen also allows the user to enable or disable Auto-Negotiation and set the Advertised Ability.

```
Event Message Line

                                6E122-26 LOCAL MANAGEMENT

                                High Speed Interface Configuration

Module Type: 6E122-26                Firmware Revision:  XX.XX.XX
Slot Number: X                       BOOTPROM Revision: XX.XX.XX

Port Type                Port 25                Port 26
Link Status              FE-100TX                Unknown
Link Status              Link                  No Link
Current Oper. Mode       100Base-TXFD           [N/A]
Desired Oper. Mode       [Auto-Negotiation]     [N/A]
Advertised Ability       [100Base-TXFD] [Disabled] [N/A]

SAVE                        EXIT                        RETURN
```

Figure 5-28 High Speed Interface Configuration Screen for the 6E12X-26

The following briefly explains each field of the High Speed Interface Configuration screen.

Port Type (Read-Only)

Displays the name of the interface (FE-100FX, FE-100TX or FE-100F3) installed in ports 25 and 26. Figure 5-28 shows that there is an FE-100TX interface installed in port 25 and no interface, indicated by Unknown, in Port 26.

Link Status (Read-Only)

Indicates whether or not there is a physical connection from this port to another 10BASE-F or 100BASE-TX/FX device. One of the following values is displayed:

- **Link** – There is a link signal present and a valid physical connection to another 10BASE-F or 100BASE-TX/FX device.
- **No Link** – There is no link signal present and there is no valid physical connection to another device.

Current Oper. Mode (Read-only)

This field displays the current operating mode of ports 25 and 26. Depending on the interface installed (100BASE-FX or 100BASE-TX) this field displays the following:

- With a 100BASE-FX interface: **100Base-FX** or **100Base-FXFD** (full duplex).
- With a 100BASE-TX interface: **Unknown**, **10Base-T**, **10Base-TFD** (full duplex), **100Base-TX**, or **100Base-TXFD** (full duplex).

Desired Oper. Mode (Selectable)

This field allows the user to select the desired operational mode for an interface in port 25 or 26. The field toggles between 100BASE-FX and 100BASE-FXFD (full duplex) when an FE-100FX or FE-100F3 is installed. [Section 5.22.1](#) describes how to configure a port with an FE-100FX or FE-100F3.

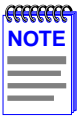

In normal operation, the port with an FE-100TX installed automatically establishes a link with the device at the other end of the segment without requiring user setup. However, Local Management provides the user with the option of manually configuring that port.

If an FE-100TX is installed, the field steps to Auto-Negotiation, 10BASE-T, 10BASE-TFD (full duplex), 100BASE-TX, and 100BASE-TXFD (full duplex). In normal operation, the port with an FE-100TX installed is capable of auto-negotiating the operational mode and no further user setup is required. [Section 5.22.3](#) describes how to configure an FE-100TX.

Advertised Ability (Selectable)

During auto-negotiation, the FE-100TX “tells” the device at the other end of the segment what its capabilities are. The capabilities of a port (25 or 26) with an FE-100TX installed are 10BASE-T, 10BASE-TFD (full duplex mode), 100BASE-TX and 100BASE-TXFD (full duplex mode). In normal operation, with all capabilities enabled, the FE-100TX “advertises” that it has the ability to operate in any mode. The Network Manager may choose to set up the port so that only a portion of the available capabilities are advertised and the others are disabled. For example, only 100BASE-TX and 100BASE-TXFD might be enabled so that only devices that operate at 100 Mbps can communicate with that port. [Section 5.22.5](#) describes how to enable or disable advertised modes.

5.22.1 Configuring an FE-100FX or FE-100F3 in Port 25 or 26

When an FE-100FX or FE-100F3 is installed in port 25 or 26, it must be manually set to operate in the same technology as the device at the other end of the connected segment. [Section 5.22.2](#) provides instructions for manually configuring the port with an FE-100FX or FE-100F3 interface.

5.22.2 Setting the FE-100FX and FE-100F3 Operational Mode

Use this field to set the active technology. This field toggles between 100BASE-FX and 100BASE-FXFD (full duplex). To set the active technology through Local Management, proceed as follows:

1. Use the arrow keys to highlight the **Desired Oper. Mode** field.
2. Use the SPACE bar to select **100Base-FX** or **100Base-FXFD** (full duplex).
3. Press ENTER. The port now operates in the chosen mode.
4. Use the arrow keys to highlight the **SAVE** command. Press ENTER. The message “SAVED OK” displays and Local Management saves the changes to memory.

5.22.3 Configuring an FE-100TX in Port 25 or 26

In normal operation, a port (25 or 26) with an FE-100TX interface automatically establishes a link with the device at the other end of the segment and no user setup is required. [Section 5.22.4](#) and [Section 5.22.5](#) provide instructions for manually configuring the port with an FE-100TX installed.

5.22.4 Setting the FE-100TX Operational Mode

Use this field to set the active technology. This field steps between Auto-Negotiation, 10BASE-T, 10BASE-TFD (full duplex), 100BASE-TX, and 100BASE-TXFD (full duplex). If Auto-Negotiation is selected, the FE-100TX automatically sets the active technology. To manually set the active technology through Local Management, proceed as follows:

1. Use the arrow keys to highlight the **Desired Oper. Mode** field.
2. Use the SPACE bar to select the desired mode. Press ENTER. If any mode other than Auto-Negotiation is selected, the port only operates in the chosen mode and auto-negotiation is disabled.
3. Use the arrow keys to highlight the **SAVE** command. Press ENTER. The message “SAVED OK” displays and Local Management saves the changes to memory. The selected mode is displayed in both the Desired Operational Mode field and the Current Operational Mode field.

5.22.5 Setting the FE-100TX Advertised Ability

In normal operation, a port (25 or 26) with an FE-100TX auto-negotiates to the highest speed possible. Under some circumstances, the Network Administrator may want the port to advertise only some of the available modes and not operate in other modes. This field steps between 10BASE-T, 10BASE-TFD (full duplex), 100BASE-TX, and 100BASE-TXFD (full duplex). To set the advertised ability, proceed as follows:

1. Use the arrow keys to highlight the **Desired Oper. Mode** field.
2. Use the SPACE bar to select the desired mode.

3. Use the LEFT-ARROW key to move back to the **Advertised Ability** selection and use the SPACE bar to select the next mode to enable or disable.
4. Use the RIGHT-ARROW key to move across to the **Enabled/Disabled** field to the right of the selection.
5. Use the SPACE bar to select **Enabled** or **Disabled**. Press ENTER. Continue this process until you have completed enabling or disabling the advertised modes.
6. Use the arrow keys to highlight the **SAVE** command. Press ENTER. The message “SAVED OK” displays and Local Management saves the changes to memory.

5.23 FLASH DOWNLOAD SCREEN

The Flash Download screen, shown in [Figure 5-29](#), allows the user to clear the information stored in the 6E12X-26 and 6E13X-25 FLASH memory and download a new image file from a TFTP server.

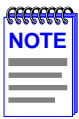

The user may also force a download by changing the position of Switch 6 located inside the module. Refer to [Section C.2, Setting the Mode Switch](#), for details.

Before downloading a new image to the module, load the image onto the network TFTP server.



For information on how to set up a workstation as a TFTP server, refer to the specific workstation documentation.

Access the Flash Download screen from the Module Specific Configuration screen by using the arrow keys to highlight the **FLASH DOWNLOAD** menu item and pressing ENTER. The Flash Download screen displays.

Reboot After Download (Modifiable when **RUNTIME** is chosen only)

This field notifies the user that the 6E12X-26 and 6E13X-25 will reboot after the download is complete. If a **RUNTIME** Download is performed, this field toggles between YES and NO. If YES is selected, the module reboots after the download is completed. If NO is selected the module continues using the existing the firmware image. The module stores the new firmware image in FLASH memory. When the module or 6C105 chassis is reset, the module will boot from FLASH memory using the new image.

TFTP Gateway IP Addr (Selectable)

This field shows the IP address of the TFTP gateway server defined in the General Configuration screen in [Section 5.15.4, Setting the TFTP Gateway IP Address](#).

Last Image Server IP (Read-only)

This field shows the IP address of the server used for the previous FLASH Download.

Last Image File Name (Read-only)

This field shows the complete path and file name of the last image downloaded to FLASH.

If **TFTP** or **RUNTIME** is selected as the download method ([Figure 5-29](#)), the following two additional fields appear:

Download Server IP (Selectable)

The IP address of the TFTP server to be used for the FLASH download is entered in this field.

Download File Name (Selectable)

The complete TFTP Server path and file name of the new image is entered in this field.

5.23.1 Image File Download Using TFTP

Set the 6E12X-26 and 6E13X-25 to download to FLASH using TFTP as follows:

1. Use the arrow keys to highlight the **Download Method** field.
2. Use the SPACE bar to select **TFTP**.
3. Use the arrow keys to highlight the **TFTP Gateway IP Addr** field.
4. Set the IP address of the TFTP gateway server (this defaults to the same IP address as that set in the TFTP Gateway IP Addr field on the General Configuration screen).
5. Use the arrow keys to highlight the **Download Server IP** field.
6. Enter the IP address of the TFTP server using the DDN format.
For example: 134.141.79.121
7. Use the arrow keys to highlight the **Download File Name** field.
8. Enter the complete pathway and file name of the image stored on the download server.
For example: /tftpboot/6E128.hex
9. Use the arrow keys to highlight **EXECUTE** at the bottom of the screen and press ENTER. The message “TFTP DOWNLOAD. WILL COMMIT TO FLASH. REBOOT IN PROGRESS...” displays in the event message line at the top of the screen and the new image is downloaded into FLASH memory.

5.23.2 Image File Download Using RUNTIME

Set the 6E12X-26 and 6E13X-25 to download to FLASH using RUNTIME as follows:

1. Use the arrow keys to highlight the **Download Method** field.
2. Use the SPACE bar to select **RUNTIME**.
3. Use the arrow keys to highlight the **Reboot After Download** field.
4. Use the SPACE bar to select either **YES** or **NO**. Select **YES** if you want the module to reboot after the download is completed. Select **NO** if you want the module to store the new image in FLASH memory until the module is manually reset.
5. Use the arrow keys to highlight the **TFTP Gateway IP Addr** field.
6. Set the IP address of the TFTP gateway server (this defaults to the same IP address as that set in the TFTP Gateway IP Addr field on the General Configuration screen).
7. Use the arrow keys to highlight the **Download Server IP** field.
8. Enter the IP address of the TFTP server using the DDN format.
For example: 134.141.79.121
9. Use the arrow keys to highlight the **Download File Name** field.
10. Enter the complete pathway and file name of the image stored on the download server.
For example: /tftpboot/6E128.fls
11. Use the arrow keys to highlight **EXECUTE** at the bottom of the screen and press ENTER. The message “RUNTIME DOWNLOAD. WILL COMMIT TO FLASH.” displays in the event message line at the top of the screen and the new image is downloaded into FLASH memory.

5.23.3 Image File Download Using BootP

Set the 6E12X-26 and 6E13X-25 to download to FLASH using BootP as follows:

- 1.** Use the arrow keys to highlight the **Download Method** field.
- 2.** Use the SPACE bar to select **BOOTP**.
- 3.** Use the arrow keys to highlight the **TFTP Gateway IP Addr** field. Set the IP address of the TFTP gateway server (this defaults to the same IP address set in the TFTP Gateway IP Addr field in the General Configuration screen).
- 4.** Use the arrow keys to highlight **EXECUTE** at the bottom of the screen and press ENTER. The message “BOOTP DOWNLOAD. WILL COMMIT TO FLASH. REBOOT IN PROGRESS...” displays in the event message line at the top of the screen and the new image is downloaded into FLASH memory.

5.24 PORT REDIRECT FUNCTION SCREEN



The Port Redirect Function screen may not be available depending on the operational mode that has been set for the module. Refer to your Release Notes to see what operational modes support the Port Redirect Function. Refer to [Section 5.15.9, Setting the Operational Mode](#), for instructions on configuring the operational mode of the module.

The Port Redirect Function screen, [Figure 5-30](#), allows the user to set each one of the ports on the 6E12X-26 and 6E13X-25 as a source or destination port. A port can be set to have one or more destination ports. For example, port 1 can be set as a source port with three destinations, ports 2, 3, and 4. Traffic from port 1 is then automatically redirected to ports 2, 3, and 4. Port 1 can also serve as a destination port for other ports. The port redirect function is extremely useful for troubleshooting purposes, as it allows traffic to be sent to a particular port(s) where, with the use of an analyzer or RMON probe, all current traffic from the source port(s) can be examined.



Although all traffic from the source port (including, if desired, errored frames) is sent to the destination port, normal switching is still performed for all frames on the source port.

Access the Port Redirect Function screen from the Module Specific Configuration Menu screen by using the arrow keys to highlight the **PORT REDIRECT FUNCTION** menu item and pressing ENTER. The Port Redirect Function screen displays.

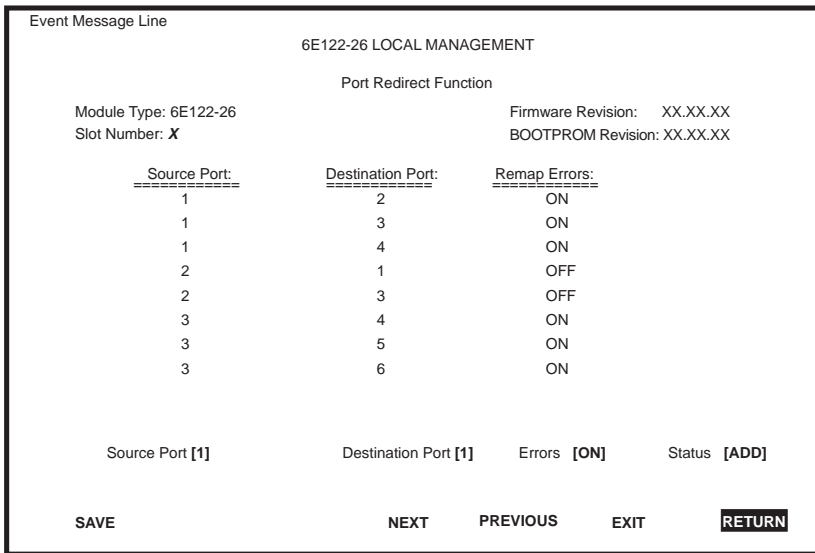

1960_22

Figure 5-30 Port Redirect Function Screen

The following definitions briefly explain each field of the Port Redirect Function screen:

Source Port (Read-only)

Shows which ports are currently set as source ports.

Destination Port (Read-only)

Shows which ports are currently set as destination ports.

Remap Errors (Read-only)

Displays whether the corresponding source ports are configured to send errored frames to the destination ports, or to drop all errored frames before forwarding traffic.

Source Port [n] (Selectable)

Allows a selected port [n] to be changed to a source port.

Destination Port [n] (Selectable)

Allows a selected port [n] to be changed to a destination port.

Errors (Toggle)

Allows the user to configure the source ports to either send errored frames to selected destination ports, or to drop errored frames, and send only valid traffic to the destination ports. The default setting of this field is [ON].

Status (Selectable)

Allows you to add or delete the source and destination ports selected in the Source Port [n] and Destination Port [n] fields.

5.24.1 Displaying the Source and Destination Entries

There can be more than one Port Redirect Function screen depending on the number of port redirect entries. Each screen displays up to 10 port redirect entries. If there is more than one screen of redirect entries, the **NEXT** and/or **PREVIOUS** command is displayed at the bottom of the screen, allowing the user to navigate to either the next or previous screen.

To display the next screen, use the arrow keys to highlight **NEXT**. Press ENTER and the next screen of entries is displayed.

To display the previous screen, use the arrow keys to highlight **PREVIOUS**. Press ENTER to view the entries in the previous screen.

5.24.2 Changing Source and Destination Ports

Add or delete source port and destination port entries as follows:

1. Use the arrow keys to highlight the **Source Port** field.
2. Press the SPACE bar or BACKSPACE one or more times to increment or decrement the port number displayed in the brackets [n] until the appropriate port number is displayed.
3. Use the arrow keys to highlight the **Destination Port** field.
4. Use the SPACE bar or BACKSPACE to step to the appropriate port number for the destination port.
5. Use the arrow keys to highlight the **Status** field.
6. Use the SPACE bar to select either the **ADD** or **DEL** (delete) option. Press ENTER. This adds or deletes the port selections made in steps 2 and 4 and also updates the screen Source Port and Destination Port list.

7. Use the arrow keys to highlight the **Errors** field.
8. Use the SPACE bar to select either the **ON** or **OFF** option and press ENTER. **ON** forces the source module and port to forward errored frames to the destination module(s) and port(s). **OFF** forces the errored frames to be dropped before forwarding traffic.

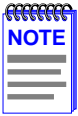

If more than one port is to be redirected, repeat steps 1 through 8 for each additional setting, then go to step 9 to save all the new settings at once.

9. Use the arrow keys to highlight **SAVE** at the bottom of the screen. Press ENTER. The message “SAVED OK” is displayed. This saves the new settings and updates the Source Interface and Destination Interface read-only fields.

5.25 BROADCAST SUPPRESSION SCREEN

The Broadcast Suppression screen, [Figure 5-31](#), allows the user to set a desired limit of receive broadcast frames per port per second.

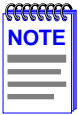

The Broadcast Suppression screen may not be available if the operational mode of the module has been set to SECURE FAST VLAN or 802.1Q SWITCHING. Refer to your Release Notes to see what operational modes support Broadcast Suppression. Refer to [Section 5.15.9, Setting the Operational Mode](#), for instructions on configuring the operational mode of the module.

Any broadcast frames received above the desired threshold will be dropped.

Access the Broadcast Suppression screen from the Module Specific Configuration screen by using the arrow keys to highlight the **BROADCAST SUPPRESSION** menu item and pressing ENTER. The Broadcast Suppression screen displays.

Event Message Line						
6E122-26 LOCAL MANAGEMENT						
Broadcast Suppression						
Module Type: 6E122-26			Firmware Revision: XX.XX.XX			
Slot Number: X			BOOTPROM Revision: XX.XX.XX			
PORT #	Total RX	Peak Rate	Time Since Peak	Threshold	Reset Peak	
1	12345678910	150000	999:23:59	150000	[NO]	
2	12345678910	150000	999:23:59	150000	[NO]	
3	12345678910	150000	999:23:59	150000	[NO]	
4	12345678910	150000	999:23:59	150000	[NO]	
5	12345678910	150000	999:23:59	150000	[NO]	
6	12345678910	150000	999:23:59	150000	[NO]	
7	12345678910	150000	999:23:59	150000	[NO]	
8	12345678910	150000	999:23:59	150000	[NO]	
9	12345678910	150000	999:23:59	150000	[NO]	
10	12345678910	150000	999:23:59	150000	[NO]	
11	12345678910	150000	999:23:59	150000	[NO]	
12	12345678910	150000	999:23:59	150000	[NO]	
SAVE		EXIT		[13-24]	RETURN	

1960_56

Figure 5-31 Broadcast Suppression Screen

The following explains each field of the Broadcast Statistics screen:

PORT # (Read-only)

Identifies the number of the port.

Total RX (Read-Only)

Displays the total number of broadcast frames received.

Peak Rate (Read-Only)

Displays the number of broadcast frames received per second.

Time Since Peak (Read-Only)

Displays the time since peak broadcast frames received.

Threshold (Modifiable)

Allows the user to set the desired limit of receive broadcast frames that will be forwarded per port per second.

Reset Peak (Modifiable)

Allows the user to reset the peak rate. Resetting the Peak Rate also resets the Time Since Peak field. The Reset Peak field toggles between YES and NO.

[1-12], or [13-24] (Navigation Key)

When the Broadcast Statistics screen displays, the current statistics are displayed for the first 12 ports. This field allows the user to step to a second screen for the same type of information for ports 13 through 24. While on the second screen, the user can navigate back to the first screen by selecting the **[1-12]** option. The user can change the Threshold or Reset Peak Rate fields while in the first or second screen.

5.25.1 Setting the Threshold

To set the Threshold, proceed as follows:

1. Use the arrow keys to highlight the **Threshold** field for the selected port.
2. Type in the numbers for the desired limit in increments of 10.
3. Use the arrow keys to highlight the **SAVE** command at the bottom of the screen.
4. Press ENTER. The message "SAVED OK" is displayed.

5.25.2 Setting the Reset Peak Switch

To set the Reset Peak Switch field to **YES** or **NO**, proceed as follows:

1. Use the arrow keys to highlight the **Reset Peak** field for the selected port.
2. Press the SPACE bar to select **YES** or **NO**.
3. Use the arrows keys to highlight the **SAVE** command at the bottom of the screen.
4. Press ENTER. The message “SAVED OK” is displayed.

5.26 MODULE STATISTICS MENU SCREEN

The Module Statistics Menu screen, [Figure 5-32](#), provides access to screens that allow the user to obtain switch statistics about frame traffic through each interface, to view MIB-II statistics from each interface, and to view RMON Statistics gathered by the RMON agent embedded in the 6E12X-26 and 6E13X-25.



The following menu item on the Module Statistics Menu screen will not display if the operational mode of the module has been set to SECURE FAST VLAN:

SWITCH STATISTICS

[Section 5.15.9](#) provides instructions on setting the operational mode.

Access the Module Statistics Menu from the Module Menu screen by using the arrow keys to highlight the **MODULE STATISTICS** menu item and pressing ENTER. The Module Statistics Menu screen displays.

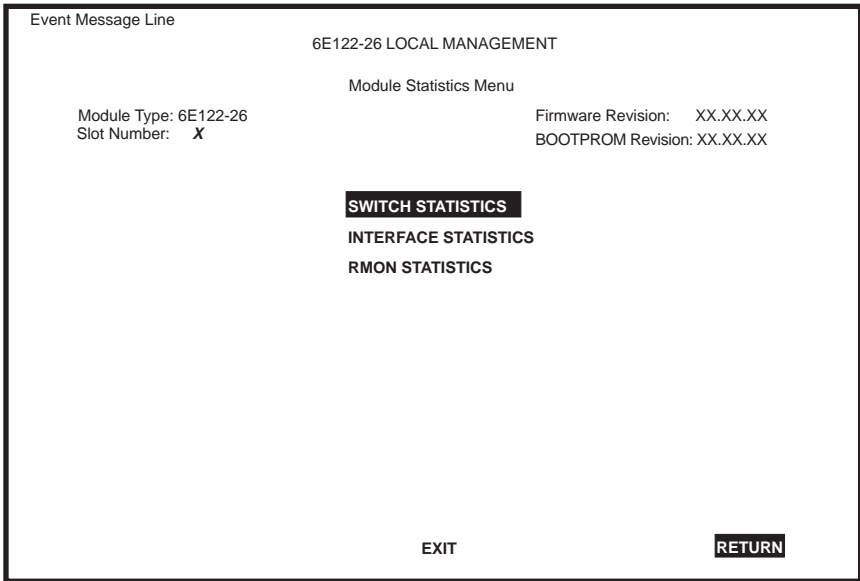

22511-67

Figure 5-32 Module Statistics Menu Screen

The Module Statistics Menu screen displays the following menu items:

SWITCH STATISTICS

The Switch Statistics screen lists the number of frames received, transmitted, filtered, and forwarded by each interface.

INTERFACE STATISTICS

The Interface Statistics screen provides the MIB-II statistics for each switched interface, on an interface-by-interface basis.

RMON STATISTICS

The RMON Statistics screen displays all the statistics gathered by the embedded RMON agent built-in to the 6E12X-26 and 6E13X-25.

5.27 SWITCH STATISTICS SCREEN

The Switch Statistics screen, [Figure 5-33](#), lists the number of frames received, transmitted, filtered, and forwarded by each interface, including backplane interfaces.

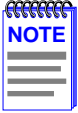

The Switch Statistics screen will not be available if the operational mode of the module has been set to SECURE FAST VLAN. This screen may only be used by modules configured to operate as traditional or 802.1Q switches.

Access the Switch Statistics screen from the Module Statistics Menu screen by using the arrow keys to highlight the **SWITCH STATISTICS** menu item and pressing ENTER. The Switch Statistics screen displays.

Event Message Line				
6E122-26 LOCAL MANAGEMENT				
Switch Statistics				
Module Type: 6E122-26		Firmware Revision: XX.XX.XX		
Slot Number: X		BOOTPROM Revision: XX.XX.XX		
Interface #	Frames Rcvd	Frames Txmtd	Frames Fltrd	Frames Frwded
1	100	100	0	100
2	100	100	0	100
3	100	100	0	100
4	100	100	0	100
5	100	100	0	100
6	100	100	0	100
7	100	100	0	100
8	100	100	0	100
9	100	100	0	100
10	100	100	0	100
11	100	100	0	100
12	100	100	0	100
[13-24]	CLEAR COUNTERS	EXIT	RETURN	

1960_26

Figure 5-33 Switch Statistics Screen

The Switch Statistics screen displays the following menu items:

Interface # (Read-Only)

Identifies the interface or port number.

Frames Rcvd (Read-Only)

Displays the number of frames received by the interface.

Frames Txmtd (Read-Only)

Displays the number of frames transmitted by the interface.

Frames Fltrd (Read-Only)

Displays the number of frames filtered by the interface.

Frames Frwded (Read-Only)

Displays the number of frames forwarded by the interface.

[1-12], [13-24], or [25-26] (6E12X-26), [25] (6E13X-25) (Selectable)

When the Switch Statistics is displayed, the statistics are displayed for the first 12 ports. These fields allow the user to step to a second or third screen for the same type of information for ports 13 through 24 or ports 25 and 26 of the 6E12X-26 and port 25 (HSIM) of the 6E13X-25. While on the second or third screen, the user can navigate back to earlier screens by highlighting the [1-12] and/or [13-24] fields and pressing ENTER.

CLEAR COUNTERS (Command)

This command is used to reset all statistic counters to zero. For details on how to use this field, refer to [Section 5.27.1](#).

5.27.1 Using the Clear Counters Command

To reset all the statistics counters to zero, perform the following steps:

1. Use the arrow keys to highlight the **CLEAR COUNTERS** field.
2. Press ENTER, the counters for the selected port are reset to zero.

5.28 THE INTERFACE STATISTICS SCREEN

The Interface Statistics screen is used to gather MIB-II statistics for all of the 6E12X-26 and 6E13X-25 interfaces (ports 1 through 24 and Fast Ethernet Interface Modules and all backplane interfaces) with the exception of an HSIM installed in the 6E13X-25.

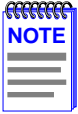

Cabletron Systems HSIMs gather their own statistics, and may be viewed via the Local Management screens of the applicable HSIM. Refer to your HSIM documentation for information on how to access these screens.

Access the Interface Statistics screen by using the arrow keys to highlight the **INTERFACE STATISTICS** menu item on the Module Statistics Menu screen and pressing ENTER. The Interface Statistics screen, [Figure 5-34](#), displays.

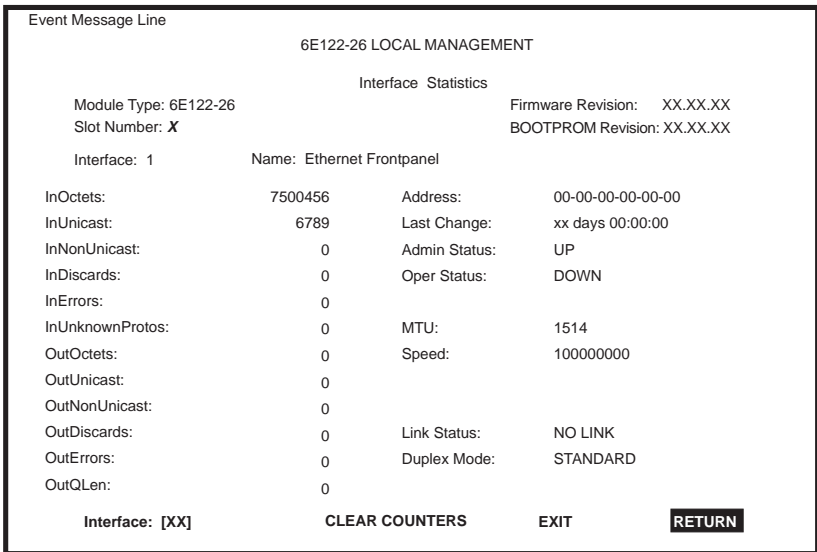

2269_29

Figure 5-34 Interface Statistics Screen

The following definitions explain each field of the Interface Statistics screen:

Interface (Read-only)

This field displays the Interface number for which statistics are currently being displayed. [Figure 5-34](#) shows the Interface field displaying 1. This represents port 1 of the module. To view other interface statistics, refer to [Section 5.28.1](#).

Name (Read-only)

The Name field displays the type of interface for which statistics are being displayed.

InOctets (Read-only)

This field displays the total number of octets (bytes) that have been received on the interface. This includes all octets from bad frames, and framing characters.

InUnicast (Read-only)

The InUnicast field displays the total number of frames that have been received that were sent to a single address.

InNonUnicast (Read-only)

This field displays the total number of frames that have been received that were delivered to a broadcast or multicast address.

InDiscards (Read-only)

The InDiscards field displays the total number of inbound frames that were discarded, even though the frames contained no errors. This field may increment because the switch needed to free up buffer space, or the switch was being overutilized.

InErrors (Read-only)

This field displays the total number of inbound frames that have been discarded because they contained errors. This field represents the total number of errored frames, regardless of the cause of the error.

InUnknownProtos (Read-only)

The InUnknownProtos field displays the total number of frames that were discarded because the frames were in an unknown, or unsupported, format.

OutOctets (Read-only)

This field displays the total number of octets (bytes) that have been transmitted from the interface.

OutUnicast (Read-only)

The OutUnicast field displays the total number of packets transmitted that were sent to a single address.

OutNonUnicast (Read-only)

This field displays the total number of frames transmitted to a broadcast or multicast address.

OutDiscards (Read-only)

The OutDiscards field displays the total number of outbound frames that were discarded, even though the frames contained no errors. This field may increment, because the switch needed to free up buffer space, or the switch was being overutilized.

OutErrors (Read-only)

This field displays the total number of outbound frames discarded because they contained errors. This field represents the total number of errored frames, regardless of the cause of the error.

OutQLen (Read-only)

The OutQLen field displays the length of the packet queue. The field represents the total number of packets that can be contained in the queue.

Address (Read-only)

This field displays the MAC Address of the interface that is currently being displayed.

Last Change (Read-only)

This field displays the last time that the interface was reset.

Admin Status (Read-only)

This field displays the current status of the interface. If this field displays “Testing”, no frames may be passed on this interface.

Oper Status (Read-only)

This field displays the current status of the interface. If this field displays “Testing”, no frames may be passed on this interface.

MTU (Read-only)

The MTU field displays the maximum frame size (in octets) that a frame may contain to be received or transmitted from this interface.

Speed (Read-only)

The Speed field displays the theoretical maximum amount of bandwidth that the interface can support in bits per second.

Link Status (Read-only)

This field displays the current link status of the interface. This field will read either “Link” or “No Link”.

Duplex Mode (Read-only)

This field indicates whether the interface is operating in normal or full duplex mode. This field will read either “Standard” or “Full Duplex”.

Interface [XX] (Command)

This command is used to enter an interface number for viewing statistics. For instructions on how to use this command, refer to [Section 5.28.1](#).

CLEAR COUNTERS (Command)

This command is used to reset all statistic counters to zero. For details on how to use this field, refer to [Section 5.28.2](#).

5.28.1 Displaying Interface Statistics

To display the statistics for any interface, proceed as follows:

1. Use the arrow keys to highlight the **Interface [XX]** field at the bottom of the screen.
2. Press the SPACE bar to increment (or press the DEL (delete) key to decrement) the interface number.
3. Press ENTER (neither the **Interface #** fields nor the statistics will change until ENTER is pressed).

5.28.2 Using the Clear Counters Command

To reset all the statistics counters of the selected interface to zero, perform the following steps:

1. Use the arrow keys to highlight the **CLEAR COUNTERS** command.
2. Press ENTER, the counters for the selected interface are reset to zero.

5.29 RMON STATISTICS SCREEN

RMON statistics for each interface, on a interface-by-interface basis, are viewed through the RMON Statistics screen shown in Figure 5-35.

Access the RMON Statistics screen by using the arrow keys to highlight the **RMON STATISTICS** menu item on the Module Statistics Menu screen and pressing ENTER. The RMON Statistics screen displays.

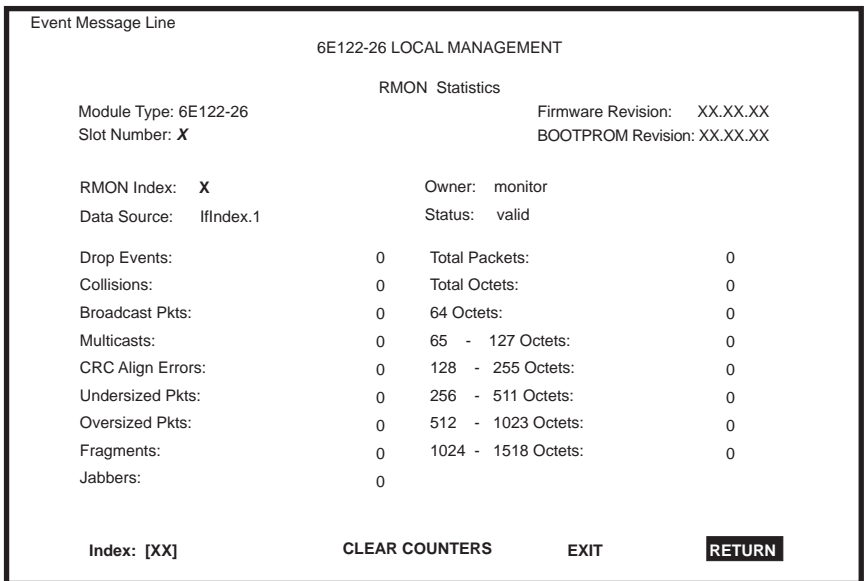

2269_65

Figure 5-35 RMON Statistics Screen

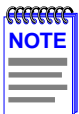

The RMON Statistics screen provides statistics for all front panel Ethernet interfaces, and any Fast Ethernet Interface Modules installed in the 6E12X-26. RMON Statistics are not gathered for an HSIM installed in the 6E13X-25.

The following definitions explain each field of the RMON Statistics screen:

RMON Index (Read-only)

This field displays the current Ethernet interface for which statistics are being shown. The 6E12X-26 and 6E13X-25 have an embedded RMON agent that gathers statistics for each interface on the module.

Data Source (Read-only)

This field displays the source of the statistics data that is currently being displayed on the screen. **Figure 5-35** shows that the data source for this RMON index is Interface 1 (port 1) by displaying the name IfIndex.1. If the screen was displaying RMON statistics for Interface 22 (port 22), the name displayed would be IfIndex.22.

Owner (Read-only)

This field displays the name of the entity that configured this entry.

Status (Read-only)

The Status field displays the current operating status of the displayed interface. This field will display “Valid” or “Invalid”.

Drop Events (Read-only)

This field displays the total number of times that the RMON agent was forced to discard frames due to the lack of available switch resources.

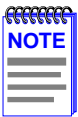

The Drop Events field does not display the number of frames dropped, it only displays the number of times that the RMON agent was forced to discard frames.

Collisions (Read-only)

This field displays the total number of collisions that have occurred on this interface.

Broadcast Pkts (Read-only)

The Broadcast Pkts field displays the total number of good frames that were directed to the broadcast address. The value of this field does not include multicast frames.

Multicasts (Read-only)

The Multicasts field displays the total number of good frames received that were directed to a multicast address. The value of this field does not include frames directed to the broadcast address.

CRC Align Errors (Read-only)

This field displays the number of frames with bad Cyclic Redundancy Checks (CRC) received from the network. The CRC is a 4-byte field in the data frames that ensures that the data received is the same as the data that was originally sent.

Undersized Pkts (Read-only)

The Undersized Pkts field displays the number of frames received whose size was less than the minimum Ethernet frame size of 64 bytes, not including preamble, but have a valid CRC.

Oversized Pkts (Read-only)

The Oversized Pkts field displays the number of frames received whose size exceeded 1518 data bytes, not including preamble, but have a valid CRC.

Fragments (Read-only)

This field displays the number of received frames that are not the minimum number of bytes in length or received frames that had a bad Frame Check Sequence (FCS), were less than 64 bytes in length (excluding framing bits, but including FCS bytes), and have an invalid CRC.



It is normal for the Fragments field to increment. This is because the RMON agent increments the field when runts are detected (which are normal occurrences due to collisions) and when noise hits occur.

Jabbers (Read-only)

This field displays the total number of frames that were greater than 1518 bytes and had either a bad FCS or a bad CRC.

Total Packets (Read-only)

This field displays the total number of frames (including bad frames, broadcast frames, and multicast frames) received on this interface.

Total Octets (Read-only)

This field displays the total number of octets (bytes) of data, including those in bad frames, received on this interface.

64 Octets (Read-only)

Displays the total number of frames including bad frames, received that were 64 bytes in length (excluding framing bits, but including FCS bytes).

65 - 127 Octets (Read-only)

Displays the total number of frames, including bad frames, received that were between 65 and 127 bytes in length (excluding framing bits, but including FCS bytes).

128 - 255 Octets (Read-only)

Displays the total number of frames, including bad frames, received that were between 128 and 255 bytes in length (excluding framing bits, but including FCS bytes).

256 - 511 Octets (Read-only)

Displays the total number of frames, including bad frames, received that were between 256 and 511 bytes in length (excluding framing bits, but including FCS bytes).

512 - 1023 Octets (Read-only)

Displays the total number of frames, including bad frames, received that were between 512 and 1023 bytes in length (excluding framing bits, but including FCS bytes).

1024 - 1518 Octets (Read-only)

Displays the total number of frames, including bad frames, received that were between 1024 and 1518 bytes in length (excluding framing bits, but including FCS bytes).

Index [XX] (Command)

This command is used to enter an index number for viewing statistics. For instructions on how to use this command, refer to [Section 5.29.1](#).

CLEAR COUNTERS (Command)

This command is used to reset all statistic counters to zero. For details on how to use this field, refer to [Section 5.29.2](#).

5.29.1 Displaying RMON Statistics

To display the statistics for any index, proceed as follows:

1. Use the arrow keys to highlight the **Index [XX]** field at the bottom of the screen.
2. Press the SPACE bar to increment (or press the DEL [delete] key to decrement) the index number.
3. Press ENTER (neither the **RMON Index** field nor the statistics will change until ENTER is pressed).

5.29.2 Using the Clear Counters Command

To reset all the statistics counters of the selected interface to zero, perform the following steps:

1. Use the arrow keys to highlight the **CLEAR COUNTERS** field.
2. Press ENTER, the counters for the selected index are reset to zero.

5.30 NETWORK TOOLS

The Network Tools function resides on both the 6E12X-26 and 6E13X-25 and allows the user to access and manage network devices.

Access the Network Tools screen by using the arrow keys to highlight the **NETWORK TOOLS** menu item in the Module or Chassis Menu screen and pressing ENTER. The Network Tools screen displays.

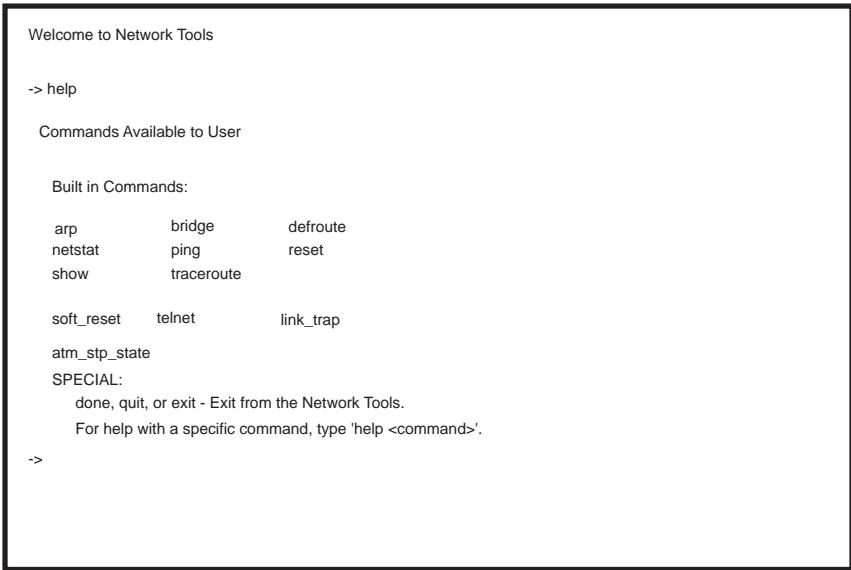

090829

Figure 5-36 Network Tools Help Screen

The Network Tools functions are performed using a series of commands. Entering commands in Network Tools involves typing the command to be executed at the Network Tools prompt, adding any desired or required extensions, and pressing ENTER.

There are two categories of commands in the command set.

- Built-in Commands – Allow the user to access and manage network devices. The commands are **arp**, **bridge**, **defroute**, **netstat**, **ping**, **reset**, **show**, **traceroute**, **soft_reset**, **telnet**, **link_trap**, and **atm_stp_state**.
- Special Commands – Allow the user to exit from Network Tools. The commands are **done**, **exit**, and **quit**.

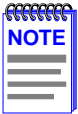

The conventions used in describing the commands in Network Tools are as follows:

Arguments enclosed by [] are required.

Arguments enclosed by < > are optional.

In the following command examples, the information entered by the user is shown in **bold** Helvetica font.

To abort the output or interrupt a process, press the CONTROL key and c key simultaneously, designated as ^C here.

The commands are presented in the following format:

command:

- Syntax:** Shows the required command format. It indicates where arguments, if any, must be specified.
- Description:** Briefly describes the command and its uses.
- Options:** Lists any additional fields in the appropriate format that may be added to the command.
- Example:** Shows an example of the command.

5.30.1 Built-in Commands

The built-in commands listed in this section activate functions on the managed device or devices being accessed through Network Tools.

arp:

- Syntax:** arp <options>
- Description:** The arp command provides access to the ARP (Address Resolution Protocol) cache, enabling you to view cache data, delete entries, or add a static route. Super-User access is required to delete an entry or add a static route.

Each ARP cache entry lists the network *interface* that the device is connected to, the device's *network address* or IP address, the device's *physical address* or MAC address, and the *media type* of connection to the device. Media types are displayed as numbers, which stand for the following states:

- 1 - Other
- 2 - Invalid entry (cannot ping device, timed out, etc.)
- 3 - Dynamic route entry
- 4 - Static route entry (not subject to change)

You can specify the arp command without options, or with one of the following options:

- Options:**
- a Views cache data
 - d Deletes an IP address entry. Requires additional arguments: <Interface Number> <IP address>
 - s Adds a static entry. Requires additional arguments: <Interface Number> <IP address> <MAC address>
 - f Flushes the ARP cache

Example:

```
-> arp -a
# Interface          Network Address    Physical Address   Media Type
# (SonicInt)         122.144.40.111    00.00.0e.12.3c.04 3(dynamic)
# (SonicInt)         122.144.48.109    00.00.0e.f3.3d.14 3(dynamic)
# (SonicInt)         122.144.52.68     00.00.0e.12.3c.04 3(dynamic)
# (SonicInt)         122.144.21.43     00.00.0e.03.1d.3c 3(dynamic)

-> arp -d 1 122.144.52.68

-> arp -s 1 22.44.2.3 00:00:0e:03:1d:3c

-> arp -f
```

051467

bridge:

Syntax: bridge [ENABLE/DISABLE] [IFNUM/ALL]

Description: The bridge command allows each bridge port to be enabled or disabled at the user's request, either one at a time or all at once. Specifying a single interface number will affect the bridging status of that interface, while specifying ALL will affect every interface.

Options: Not Applicable

Example:

```
-> bridge disable all  
  
-> bridge enable 1  
  
-> bridge disable 1
```

051468

defroute:

Syntax: defroute [interface number] [IP address]

Description: The defroute command allows the user to view, set or delete the default IP route to a managed device through the specified interface.

Options: Not Applicable

Example:

```
-> defroute 2 147.152.42.32
    # Default route is 147.152.42.32 on interface 2
-> defroute
    # Default route is 147.152.42.32 on interface 2
-> defroute delete
    # Default route is not currently set.
->
```

05141-69

netstat:**Syntax:** netstat [option]**Description:** The netstat command provides a display of general network statistics for the managed device. The netstat command must be used with one of the two display options.**Options:** -i Displays status and capability information for each interface

-r Displays routing information for each interface

Example:

```

-> netstat -i
Interface + Description      MTU      Speed      Admin  Oper  MAC Addr
# 1 (ethernet - csmacd)    1514     10000000   up     up    0x00 0x00 0x1d 0x07 0x50 0x0e
# 2 (ethernet - csmacd)    1514     10000000   up     up    0x00 0x00 0x1d 0x07 0x50 0x0f
# 3 (ethernet - csmacd)    1514     10000000   up     up    0x00 0x00 0x1d 0x07 0x50 0x10
# 4 (ethernet - csmacd)    1514     10000000   up     up    0x00 0x00 0x1d 0x07 0x50 0x11

-> netstat -r
Destination                Next-hop                Interface
# Default Route            DirectConnection        1
# 134.141.0.0              DirectConnection        2
# 134.141.0.0              DirectConnection        3

```

051470

ping:**Syntax:** ping [IP address]**Description:** The ping command generates an outbound ping request to check the status (alive/not alive) of a device at a specified IP address.**Options:** Not Applicable**Example:**

```

-> ping 122.144.40.10
122.144.40.10 is alive

```

051471

reset:

Syntax: reset

Description: The reset command allows a soft reset of the device. The user will be queried to confirm the reset command to insure against unwanted resets.



The Network Tools connection to the module will be terminated upon execution of this command.

Options: Not Applicable

Example:

```
-> reset
```

174245

show:

Syntax: show [PROTOCOL] [TABLE]

Description: The show command displays information concerning various components of the device. Protocols currently supported are IP, IPX, DECnet, and AppleTalk. Components of those protocols that are currently supported are ARP caches, route tables, FIB tables, server tables, and interface tables. The number of valid entries in the table will be displayed at the end of the table display.

Options: Not Applicable

Example:

```
-> show Appletalk interfaces

# Interface  AdminStatus  OperStatus  MTU  Forwarding  Framing
# 1          enabled      enabled     1500  enabled     ethernet
# 2          disabled   disabled    1500  disabled    ethernet

-> show IP ARP

# Interface  MediaType  PhysicalAddress  NetworkAddress
# 3          3 (dynamic)  00:00:1d:04:40:5d  123.456.40.1
# 4          3 (dynamic)  08:00:20:0e:d8:31  123.456.40.30
```

174246

traceroute:

Syntax: traceroute [IP address]

Description: The traceroute command generates a TRACEROUTE request to a specified IP address and provides a display of all next-hop routers in the path to the device. If the device is not reached, the command displays all next-hop routers to the point of failure.

Options: Not Applicable

Example:

```
-> traceroute 122.144.11.52

# next-hop[0] : 122.144.60.45
# next-hop[1] : 122.144.8.113
# next-hop[2] : 122.144.61.45
# 122.144.11.52 is alive : 3 hops away.
```

051477

soft_reset:

Syntax: soft_reset

Description: This command restarts the software image, which restores the user configuration settings from NVRAM. The user will be queried to confirm the reset command to ensure against unwanted resets.



The Network Tools connection to the module will be terminated upon execution of this command.

Options: Not Applicable

Example:

```
-> soft-reset
```

174266

telnet:

Syntax: telnet [IP address] [Port #]

Description: The telnet command allows the user to communicate with another host (that supports Telnet connections) using the Telnet protocol. The user must specify the remote host using its IP address. The [IP address] field is mandatory. If no Port number is specified, telnet will attempt to contact the host at the default port.

Options: [Port #]

Example:

```
-> telnet 134.141.12.345
Trying 134.141.12.345
Connected to 134.141.12.345

SunOS UNIX (server1)

login:
```

link_trap:

Syntax: link_trap [enable/disable/status] [PORT/all]

Description: The link_trap command allows link traps to be enabled or disabled when specifying a single port, or simultaneously when specifying “all” or no ports. When one or all ports are specified to enable, disable, or find their status, their current condition is displayed.

Options: Not Applicable

Example:

```
-> link_trap status
LINK TRAP STATUS:
    Port 1 is ENABLED      Port 2 is DISABLED
    Port 3 is ENABLED      Port 4 is ENABLED

-> link_trap disable 2
Link traps have been DISABLED on port 2

-> link_trap disable all
Link traps have been DISABLED on all ports (1-24)

-> link_trap status 3
Link traps are ENABLED on port 3
```

atm_stp_state:



The **atm_stp_state** command is only available if an HSI-M-A6DP is installed in the module (e.g., 6E13X-25). This command allows the user to enable, disable, or check the current status of the Spanning Tree Algorithm on all ATM interfaces.

Syntax: atm_stp_state [STATE]

Description: The atm_stp_state command allows the user to enable, disable, or check the status of the Spanning Tree Algorithm on all ATM interfaces. The user must specify the STATE option as enable, disable, or status. The STATE field is mandatory.

Options: enable, disable, status

Example:

```
-> atm_stp_state status
Atm Stp is Enabled
-> atm_stp_state disable
-> atm_stp_state enable
```

5.30.2 Special Commands

done, quit, exit:

Syntax: done

Description: The done command enables the user to exit from Network Tools and return to the Main Menu screen.

Options: Not Applicable

Example:

```
-> done
Connection closed
```

051472

APPENDIX A

SPECIFICATIONS

This appendix provides operating specifications for the Cabletron Systems 6E132-25, 6E122-26, 6E133-25 and 6E123-26 Interface Modules. Cabletron Systems reserves the right to change these specifications at any time without notice.

A.1 DEVICE SPECIFICATIONS

Processor:	Intel i960 RISC processor control
Dynamic Random Access Memory (DRAM):	16 MB
FLASH Memory:	4 MB

A.2 PHYSICAL PROPERTIES

Dimensions:	43.87 H x 5.71 W x 27.88 D (cm) 18.28 H x 2.38 W x 11.62 D (in)
Weight (Unit):	2.72 kg (6 lb)
MTBF (Predicted):	200,000 hours

A.3 ENVIRONMENTAL REQUIREMENTS

Operating Temperature:	5° to 40°C (41° to 104°F)
Storage Temperature:	-30° to 73°C (-22° to 164°F)
Operating Relative Humidity:	5% to 90% (non-condensing)

A.4 INPUT/OUTPUT PORTS

6E122-26

Ports 1 through 24	Ethernet (10BASE-T compliant) with RJ45 type connectors.
Slots for optional Fast Ethernet Interface Modules (ports 25 and 26)	Slots accept three types of optional Fast Ethernet Interface Modules: the FE100-TX, FE100-FX and the FE-100F3.

6E132-25

Ports 1 through 24	Ethernet (10BASE-T compliant) with RJ45 type connectors.
Slot for optional HSIM	Slot accepts optional High Speed Interface Module (HSIM).

6E123-26

Ports 1 through 24	Ethernet (10BASE-T compliant) with RJ21 type connectors.
Slots for optional Fast Ethernet Interface Modules (ports 25 and 26)	Slots accept three types of optional Fast Ethernet Interface Modules: the FE100-TX, FE100-FX and the FE-100F3.

6E133-25

Ports 1 through 24	Ethernet (10BASE-T compliant) with RJ21 type connectors.
Slot for optional HSIM	Slot accepts optional High Speed Interface Module (HSIM).

A.5 COM PORT PINOUT ASSIGNMENTS

The COM port is a serial communications port that supports Local Management or connection to a UPS.

The COM port has the following pin assignments:

Table A-1 COM Port Pin Assignments

Pin	Signal Name	Input/Output
1	Transmit Data (XMT)	Output
2	Data Carrier Detect (DCD)	Output
3	Data Set Ready (DSR)	Input
4	Receive Data (RCV)	Input
5	Signal Ground (GND)	NA
6	Data Terminal Ready (DTR)	Output
7	Request to Send (RTS)	Input
8	Clear to Send (CTS)	NA

A.6 REGULATORY COMPLIANCE

Safety

The 6E12X-26 and 6E13X-25 meet the safety requirements of UL 1950, CSA C22.2 No. 950, EN 60950, IEC 950 and 73/23/EEC.

Electromagnetic Compatibility (EMC)

The 6E12X-26 and 6E13X-25 meet the requirements of FCC Part 15, EN 50082-1, EN 55022, VCCI V-3, CSA C108.8, AS/NZS 3548, and 89/336/EEC.

APPENDIX B

FE-100TX, FE-100FX AND FE-100F3 SPECIFICATIONS

The 6E12X-26 supports three Fast Ethernet Interface Modules:

- FE-100TX
- FE-100FX
- FE-100F3

This appendix provides the specifications for these modules.

B.1 FE-100TX

The FE-100TX uses an RJ45 connector supporting Category 5 Unshielded Twisted Pair (UTP) cabling with an impedance between 85 and 111 ohms.

The slide switch on the FE-100TX determines the crossover status of the cable pairs. If the switch is on the **X** side, the pairs are internally crossed over. If the switch is on the **=** side, the pairs are not internally crossed over. **Figure B-1** shows the pinouts for the FE-100TX in both positions.

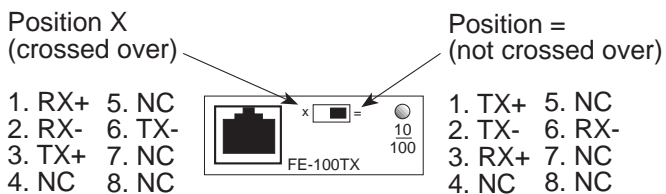

16651_05

Figure B-1 FE-100TX Pinouts

B.2 FE-100FX

The FE-100FX shown in **Figure B-2** uses an SC style connector that supports multimode fiber optic cabling. Specifications for the FE-100FX are listed below.

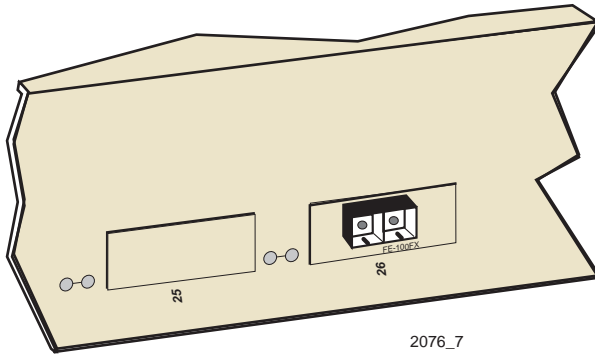

Figure B-2 FE-100FX

Table B-1 Transmitter Power

Cable Type	Worst Case Budget	Typical Budget
50/125 μm fiber	6.0 dB	9.0 dB
62.5/125 μm fiber	9.0 dB	12.0 dB
100/140 μm fiber	15.0 dB	18.0 dB



The transmitter power levels and receive sensitivity levels listed are peak power levels after optical overshoot. A peak power meter must be used to correctly compare the values given above to those measured on any particular port. If power levels are being measured with an average power meter, add 3 dB to the measurement to compare the measured values to the values listed above.

B.3 FE-100F3

The FE-100F3 shown in [Figure B-3](#) uses an SC style connector that supports single mode fiber optic cabling. Specifications for the FE-100F3 are listed in [Table B-2](#) below.

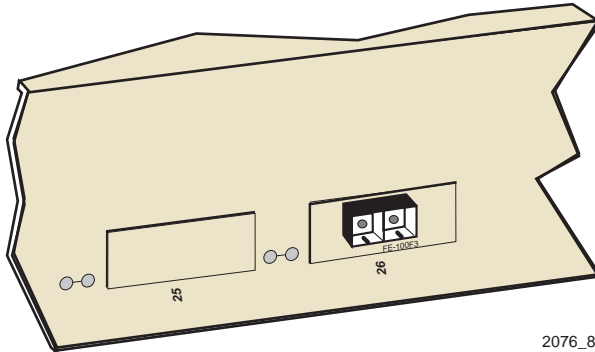

2076_8

Figure B-3 FE-100F3

Table B-2 Transmitter Power

Cable Type	Worst Case Budget	Typical Budget
8/125 μm fiber	>10.0 dB	<10.0 dB
12/125 μm fiber	>10.0 dB	<10.0 dB



The transmitter power levels and receive sensitivity levels listed are peak power levels after optical overshoot. A peak power meter must be used to correctly compare the values given above to those measured on any particular port. If power levels are being measured with an average power meter, add 3 dB to the measurement to compare the measured values to the values listed above.

APPENDIX C

MODE SWITCH BANK SETTINGS AND OPTIONAL INSTALLATIONS

This appendix covers the following items:

- Required tools ([Section C.1](#))
- Locations, functions, and settings for the mode switches ([Section C.2](#))
- Installing Optional Fast Ethernet Interface Modules ([Section C.3](#))

C.1 REQUIRED TOOLS

You need the following tools to perform the procedures provided in this appendix:

- Antistatic wrist strap (provided with 6C105 chassis)
- Phillips screwdriver

C.2 SETTING THE MODE SWITCH



The following procedures may also be performed through Local Management. The mode switches should only be used if it is not possible to make a Local Management connection. Refer to [Chapter 5, Local Management](#), for instructions on how to perform these tasks.

These mode switches are set at the factory and do not need to be changed unless you intend to perform the following:

- Force download a new image file from a BootP server.
- Clear NVRAM and restore all user-entered parameters such as the IP address and subnet masks to the 6E12X-26 and 6E13X-25 “Default” configuration settings.
- Clear user-entered passwords stored in NVRAM and restore the default passwords.

Figure C-1 shows the location of the mode switches and the switch settings for normal operation.

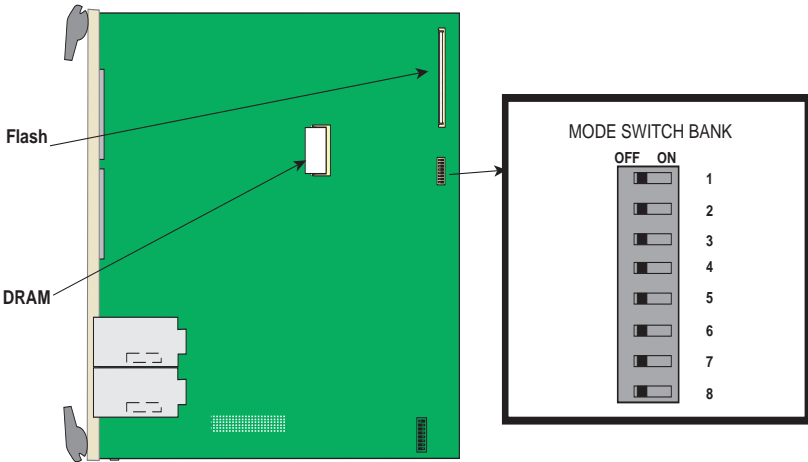
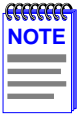

Figure C-1 6E12X-26 and 6E13X-25 Mode Switch Location/Component Layout

Switch definitions and positions are as follows:

- Switches 1 through 4 – For Cabletron Systems use only.
- Switch 5 – COM Port Autobaud. The default (OFF) position enables Autobaud sensing on the COM port for Local Management sessions. Changing the switch to the ON position disables Autobaud sensing and sets the COM port to 9600 baud for Local Management sessions.
- Switch 6 – Forced BootP. Changing the position of this switch (i.e., moving the switch from one position to the other) clears download information from NVRAM and forces the 6E12X-26 and 6E13X-25 to download a new image file from a BootP server after power to the chassis is restored, or the RESET button is pressed.



After changing the position of switch 6, DO NOT reapply power to the chassis or reset the module until there is a station acting as a BootP server, which contains the image file.

- Switch 6 – After changing the position of switch 6 and restarting the module, the 6E12X-26 and 6E13X-25 request a new image download until they either receive a new image or the RESET button on the front panel is pressed. When the RESET button is pressed, the 6E12X-26 and 6E13X-25 continue trying to contact a BootP server, but will time out in approximately one minute. If the module times out, the image is downloaded from its FLASH memory.
- Switch 7 – Clear NVRAM. Changing the position of this switch resets NVRAM on either the next power up or the next operation of the front panel RESET switch. ALL user-entered parameters, such as IP addresses, subnet masks, SNMP traps, and bridging functions are restored to their factory default settings.
- Switch 8 – Reset Password/Community Strings. Changing the position of this switch clears only the user-entered passwords stored in NVRAM, and restores the default passwords. Once the 6E12X-26 and 6E13X-25 are reset, the passwords can either be reentered or the default passwords (Public and ENTER) may be used.

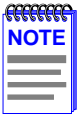

Do not change the position of switch 8 unless it is necessary to reset the module super-user configured passwords to their factory default settings.

C.3 INSTALLING OPTIONAL FAST ETHERNET INTERFACE MODULES

Figure C-2 shows the location of the Fast Ethernet Interface Module connectors on the 6E12X-26 board for port slots 25 and 26.

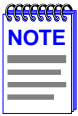

For instructions on installing a High Speed Interface Module (HSIM) in the 6E13X-25, refer to the applicable HSIM documentation.

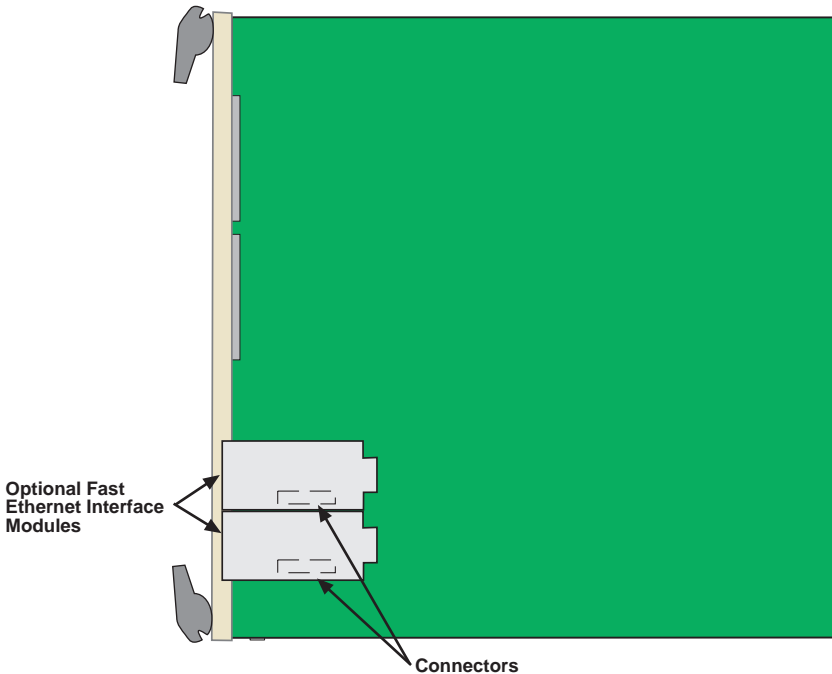

Figure C-2 Fast Ethernet Interface Module Connector Location

To install a Fast Ethernet Interface Module in port slot 25 or 26 of the 6E12X-26, proceed as follows:



The Fast Ethernet Interface Module and the host module are sensitive to static discharges. Use an antistatic wrist strap and observe all static precautions during this procedure. Failure to do so could damage the Fast Ethernet Interface Module or the host module.



The FE-100F3 uses Class 1 lasers. Do not use optical instruments to view the laser output. The use of optical instruments to view laser output increases eye hazard. When viewing the output optical port, power must be removed from the network adapter.

1. Remove the coverplate from the port slot where the Fast Ethernet Interface Module will be installed.



When installing Fast Ethernet Interface Modules in both port slots 25 and 26, remove the coverplates from both slot openings. In the following instructions, the optional module is shown being installed in port slot 26.

To remove a coverplate, refer to [Figure C-3](#) and proceed as follows:

- a. Remove the two screws fastening the coverplate to the standoffs. Save the screws.
- b. Lift and remove the coverplate from the top of the front standoffs.

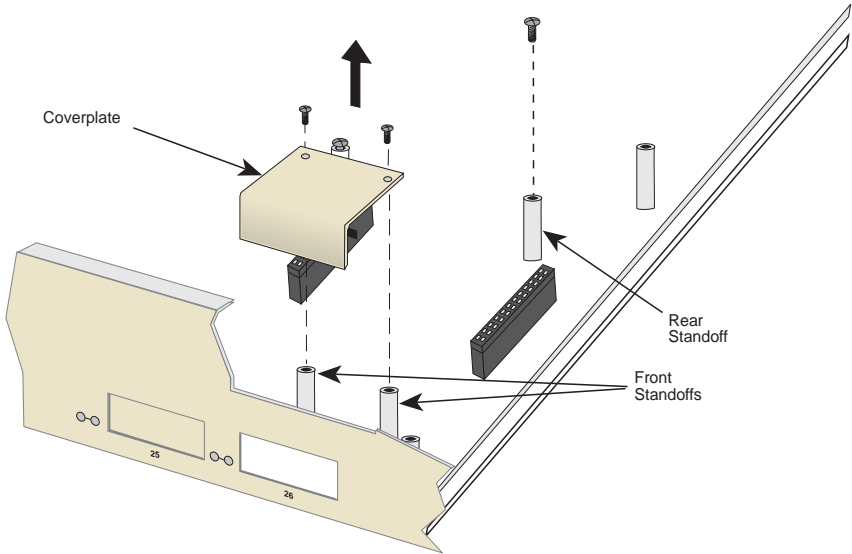

Figure C-3 Coverplate Removal

2. Remove the screw from the rear standoff. Save the screw.



When installing an FE-100FX or FE-100F3 module into the host module, remove the rubber plug on the SC connector before proceeding.

3. Refer to **Figure C-4**. Gently pull the faceplate of the host module forward to allow room for the Fast Ethernet Interface Modules to be aligned over the connector.
4. Carefully lower the Fast Ethernet Interface Module onto the standoffs while inserting the module connector into the associated motherboard connector.



When inserting the Fast Ethernet Interface Module into the motherboard connector ensure that the pins do not bend, as this can damage both the Fast Ethernet Interface Module and the motherboard connector.

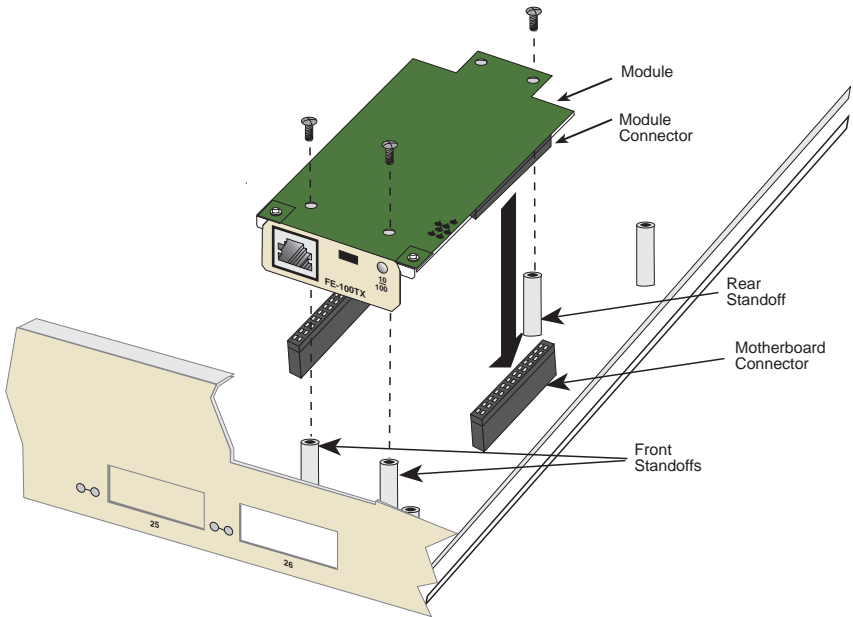

Figure C-4 Installing the Fast Ethernet Interface Module

5. Press down firmly on the Fast Ethernet Interface Module until the pins slide all the way into the motherboard connector. Ensure that the Fast Ethernet Interface Module seats flush on the standoffs.
6. Secure the Fast Ethernet Interface Module with the screws saved in steps 1 and 2.
7. Installation is complete.

INDEX

Numerics

- 100BASE-TX
 - cable length 2-2
- 10BASE-T
 - connection 3-6, 3-8
 - requirements 2-2
- 802.1Q VLAN Configuration 5-14, 5-71

A

- Access policy 5-25, 5-58

B

- Broadcast Suppression screen 5-89, 5-90, 5-91

C

- Cable specifications
 - 100BASE-FX MMF 2-2
 - 100BASE-T network 2-2
 - 100BASE-TX network 2-2
- Chassis Configuration screen
 - 802.1Q VLAN Configuration 5-14, 5-71
 - chassis date 5-16
 - chassis time 5-16
 - Chassis Uptime 5-17
 - IP address 5-16
 - Operational Mode 5-17
 - Port Redirect Function 5-14, 5-71
 - screen lock-out time 5-17, 5-21
 - screen refresh time 5-16, 5-20
 - subnet mask 5-16
- Chassis date 5-16
- Chassis Environmental Screen 5-29
- Chassis Environmental screen 5-14
- Chassis Menu screen 5-13
- Chassis time 5-16

- Chassis Uptime 5-17
- Clear NVRAM 5-45
- Clearing NVRAM 5-56
- COM port
 - pin assignments A-3
- Connecting to the network 3-5
- Crossover switch B-1
- Current switch utilization 5-73

D

- Default gateway 5-42, 5-47
- Displaying statistics 5-98, 5-103
- Download Method 5-80
- Download Server IP 5-81

E

- Environmental requirements A-1
- Ethernet Full Duplex Configuration
 - screen 5-66
 - link status 5-67
 - operation mode 5-67, 5-68
 - port status 5-67

F

- FE-100F3 B-3
- FE-100FX
 - transmitter power B-2, B-3
- Fiber connection
 - SC to SC 3-12
- Flash Download screen 5-79, 5-80, 5-81

G

- General Configuration screen 5-41
 - Clear NVRAM 5-45
 - COM port application 5-44
 - COM port configuration 5-53
 - default gateway 5-42, 5-47

- IP address 5-41, 5-45
- IP Fragmentation 5-45, 5-57
- MAC address 5-41
- Management Mode 5-44, 5-52
 - module date 5-42
 - module time 5-42, 5-48, 5-49
- Module Uptime 5-43
- Operational Mode 5-43, 5-51
 - screen lock-out time 5-43, 5-50
 - screen refresh time 5-42, 5-50
 - subnet mask 5-18, 5-42, 5-46
- TFTP Gateway IP Addr 5-42, 5-48

H

- Help
 - related manuals 1-11
 - Technical Support 1-10
- High Speed Interface screen 5-74
 - advertised ability 5-77
 - configuring an FE-100FX 5-77
 - configuring an FE-100TX 5-78
 - current operational mode 5-76
 - desired operational mode 5-76
 - link status 5-75
 - port type 5-75
 - setting the FE-100FX 5-77
 - setting the FE-100TX operational mode 5-78

I

- Image File Download Using
 - BOOTP 5-84
- Image File Download Using
 - RUNTIME 5-83
- Image File Download Using
 - TFTP 5-82
- Installation
 - Fast Ethernet Interface Module C-4
 - Installing into the chassis 3-2
- Interface Statistics screen 5-98
- IP address 5-16, 5-41, 5-45
- IP Fragmentation 5-45, 5-57

K

- Keyboard conventions 5-2

L

- LANVIEW LEDs 4-1
- Last Image File Name 5-81
- Last Image Server IP 5-81

M

- Main Menu screen 5-12
- Management Mode 5-44, 5-52
- Module Configuration screen 5-38
- Module date 5-42
- Module Menu screen 5-36, 5-37
- Module Operational Mode 5-43, 5-51
- Module Selection screen 5-34
- Module Specific Configuration Menu screen 5-69
 - Broadcast Suppression 5-71
 - Flash Download 5-71
 - High Speed Interface
 - Configuration 5-70
 - System Resources 5-70
- Module Statistics 5-37
- Module Statistics Menu screen 5-91
 - Interface statistics 5-92
 - RMON statistics 5-92
 - Switch statistics 5-92
- Module time 5-42
- Module Uptime 5-43

N

- Navigating Local Management 5-8
 - Exiting Local Management 5-10
 - Selecting items 5-10
- Network connection
 - FE-100FX 3-12
 - FX-100TX 3-10
- Network Tools 5-37, 5-104
- Network Tools Commands
 - arp 5-105
 - atm_stp_state 5-114
 - bridge 5-107

defroute 5-107, 5-108
done 5-115
link_trap 5-114
netstat 5-109
ping 5-109
reset 5-110
show 5-110
soft_reset 5-111
telnet 5-113
traceroute 5-111, 5-113, 5-115

O

Operational Mode 5-17

P

Password screen 5-7
Peak switch utilization 5-73
Physical properties A-1
Port 5-53
Port Redirect Function 5-14, 5-30,
5-71

R

Reboot after Download 5-81
RESET button 4-7
RMON Statistics screen 5-99, 5-103

S

Safety A-3
Screen lock-out time 5-17, 5-21,
5-43, 5-50
Screen refresh time 5-20, 5-50
Screens
Broadcast Suppression screen 5-89
Chassis Environmental
Screen 5-29
Chassis Menu screen 5-13
Ethernet Full Duplex Configuration
screen 5-66

Flash Download screen 5-79
General Configuration screen 5-41
High Speed Interface screen 5-74
Interface Statistics screen 5-95
Main Menu screen 5-12
Module Configuration screen 5-38
Module Menu screen 5-36
Module Selection screen 5-34
Module Specific Configuration
Menu screen 5-69
Module Statistics Menu
screen 5-91
Password screen 5-7
Port Redirect Function 5-30
Port Redirect Function screen 5-85
RMON Statistics screen 5-99
Setting community names 5-25
SNMP Community Names
screen 5-24, 5-57
SNMP Traps screen 5-27, 5-60
Switch Configuration screen 5-62
Switch Statistics screen 5-93
System Resources screen 5-72
Setting communitiy names 5-25
Setting the reset peak switch 5-91
Setting the threshold 5-90
SmartTrunk, introduction to 1-5
SNMP Community Names
screen 5-24, 5-57
access policy 5-25, 5-58
community name 5-25, 5-58
SNMP Traps screen 5-27, 5-60
enable traps 5-28
trap community name 5-27
trap destination 5-27
trap table configuration 5-28, 5-61
Spanning Tree Algorithm 5-63
Specifications A-1
Standards compatibility 1-6

- Subnet mask 5-16, 5-18, 5-42, 5-46
- Switch address 5-63
- Switch Configuration screen 5-62
 - Age Time 5-63
 - MAC address 5-64
 - Setting the Age Time 5-65
 - Setting the port status 5-65
 - Setting the STA 5-64
 - State 5-64
 - Status 5-64
 - Switch address 5-63
 - type of STA 5-63
- Switch Statistics screen 5-93
- System Resources screen 5-72
 - current switch utilization 5-73
 - DRAM installed 5-73
 - Flash memory installed 5-73
 - NVRAM installed 5-73
 - peak switch utilization 5-73
 - reset peak switch utilization 5-73

T

- TFTP Gateway IP Addr 5-42, 5-48, 5-81
- Trap table configuration 5-28, 5-61
- Traps
 - enable 5-28
- Troubleshooting 4-1
 - checklist 4-6

U

- Unpacking 3-1

Free Manuals Download Website

<http://myh66.com>

<http://usermanuals.us>

<http://www.somanuals.com>

<http://www.4manuals.cc>

<http://www.manual-lib.com>

<http://www.404manual.com>

<http://www.luxmanual.com>

<http://aubethermostatmanual.com>

Golf course search by state

<http://golfingnear.com>

Email search by domain

<http://emailbydomain.com>

Auto manuals search

<http://auto.somanuals.com>

TV manuals search

<http://tv.somanuals.com>