

**SEH-22, SEH-24, SEH-32, AND SEH-34  
10BASE-T STACKABLE HUB**

**USER'S GUIDE**

**CABLETRON**  
*SYSTEMS*<sup>INC.</sup>

---

The Complete Networking Solution™

CABLETRON SYSTEMS, P. O. Box 5005, Rochester, NH 03866-5005

**NOTICE**

Cabletron Systems reserves the right to make changes in specifications and other information contained in this document without prior notice. The reader should in all cases consult Cabletron Systems to determine whether any such changes have been made.

The hardware, firmware, or software described in this manual is subject to change without notice.

IN NO EVENT SHALL CABLETRON SYSTEMS BE LIABLE FOR ANY INCIDENTAL, INDIRECT, SPECIAL, OR CONSEQUENTIAL DAMAGES WHATSOEVER (INCLUDING BUT NOT LIMITED TO LOST PROFITS) ARISING OUT OF OR RELATED TO THIS MANUAL OR THE INFORMATION CONTAINED IN IT, EVEN IF CABLETRON SYSTEMS HAS BEEN ADVISED OF, KNOWN, OR SHOULD HAVE KNOWN, THE POSSIBILITY OF SUCH DAMAGES.

© Copyright February 1994 by:  
Cabletron Systems, Inc.  
P.O. Box 5005, Rochester, NH 03867-0505

All Rights Reserved  
Printed in the United States of America

Order Number: 9030903-01 February 94

**SPECTRUM**<sup>®</sup>, **LANVIEW**<sup>®</sup>, **Remote LANVIEW**<sup>®</sup>, **HubSTACK**<sup>™</sup>, and **MicroMMAC**<sup>™</sup> are trademarks of Cabletron Systems, Inc.

**IBM** is a registered trademark of International Business Machines Corporation.

**CompuServe** is a registered trademark of CompuServe, Inc.

**DEC**, **VT200**, and **VT300** are trademarks of Digital Equipment Corporation.

**Ethernet** is a trademark of Xerox Corporation.

**Windows** is a registered trademark of Microsoft Corporation.

Printed On



Recycled Paper

## **NOTICE**

---

### **FCC NOTICE**

This device complies with Part 15 of the FCC rules. Operation is subject to the following two conditions: (1) this device may not cause harmful interference, and (2) this device must accept any interference received, including interference that may cause undesired operation.

**NOTE:** This equipment has been tested and found to comply with the limits for a Class A digital device, pursuant to Part 15 of the FCC rules. These limits are designed to provide reasonable protection against harmful interference when the equipment is operated in a commercial environment. This equipment uses, generates, and can radiate radio frequency energy and if not installed in accordance with the operator's manual, may cause harmful interference to radio communications. Operation of this equipment in a residential area is likely to cause interference in which case the user will be required to correct the interference at his own expense.

**WARNING:** Changes or modifications made to this device which are not expressly approved by the party responsible for compliance could void the user's authority to operate the equipment.

### **DOC NOTICE**

This digital apparatus does not exceed the Class A limits for radio noise emissions from digital apparatus set out in the Radio Interference Regulations of the Canadian Department of Communications.

Le présent appareil numérique n'émet pas de bruits radioélectriques dépassant les limites applicables aux appareils numériques de la class A prescrites dans le Règlement sur le brouillage radioélectrique édicté par le ministère des Communications du Canada.

**CABLETRON SYSTEMS, INC.  
PROGRAM LICENSE AGREEMENT**

**IMPORTANT:** Before utilizing this product, carefully read this License Agreement.

This document is an agreement between you, the end user, and Cabletron Systems, Inc. ("Cabletron") that sets forth your rights and obligations with respect to the Cabletron software program (the "Program") contained in this package. The Program may be contained in firmware, chips or other media. **BY UTILIZING THE ENCLOSED PRODUCT, YOU ARE AGREEING TO BECOME BOUND BY THE TERMS OF THIS AGREEMENT, WHICH INCLUDES THE LICENSE AND THE LIMITATION OF WARRANTY AND DISCLAIMER OF LIABILITY. IF YOU DO NOT AGREE TO THE TERMS OF THIS AGREEMENT, PROMPTLY RETURN THE UNUSED PRODUCT TO THE PLACE OF PURCHASE FOR A FULL REFUND.**

**CABLETRON SOFTWARE PROGRAM LICENSE**

1. **LICENSE.** You have the right to use only the one (1) copy of the Program provided in this package subject to the terms and conditions of this License Agreement.

You may not copy, reproduce or transmit any part of the Program except as permitted by the Copyright Act of the United States or as authorized in writing by Cabletron.

2. **OTHER RESTRICTIONS.** You may not reverse engineer, decompile, or disassemble the Program.
3. **APPLICABLE LAW.** This License Agreement shall be interpreted and governed under the laws and in the state and federal courts of New Hampshire. You accept the personal jurisdiction and venue of the New Hampshire courts.

## **EXCLUSION OF WARRANTY AND DISCLAIMER OF LIABILITY**

1. **EXCLUSION OF WARRANTY.** Except as may be specifically provided by Cabletron in writing, Cabletron makes no warranty, expressed or implied, concerning the Program (including Its documentation and media).

CABLETRON DISCLAIMS ALL WARRANTIES, OTHER THAN THOSE SUPPLIED TO YOU BY CABLETRON IN WRITING, EITHER EXPRESS OR IMPLIED, INCLUDING BUT NOT LIMITED TO IMPLIED WARRANTIES OF MERCHANTABILITY AND FITNESS FOR A PARTICULAR PURPOSE, WITH RESPECT TO THE PROGRAM, THE ACCOMPANYING WRITTEN MATERIALS, AND ANY ACCOMPANYING HARDWARE.

2. **NO LIABILITY FOR CONSEQUENTIAL DAMAGES.** IN NO EVENT SHALL CABLETRON OR ITS SUPPLIERS BE LIABLE FOR ANY DAMAGES WHATSOEVER (INCLUDING, WITHOUT LIMITATION, DAMAGES FOR LOSS OF BUSINESS, PROFITS, BUSINESS INTERRUPTION, LOSS OF BUSINESS INFORMATION, SPECIAL, INCIDENTAL, CONSEQUENTIAL, OR RELIANCE DAMAGES, OR OTHER LOSS) ARISING OUT OF THE USE OR INABILITY TO USE THIS CABLETRON PRODUCT, EVEN IF CABLETRON HAS BEEN ADVISED OF THE POSSIBILITY OF SUCH DAMAGES. BECAUSE SOME STATES DO NOT ALLOW THE EXCLUSION OR LIMITATION OF LIABILITY FOR CONSEQUENTIAL OR INCIDENTAL DAMAGES, OR ON THE DURATION OR LIMITATION OF IMPLIED WARRANTIES IN SOME INSTANCES THE ABOVE LIMITATIONS AND EXCLUSIONS MAY NOT APPLY TO YOU.

## **UNITED STATES GOVERNMENT RESTRICTED RIGHTS**

The enclosed product (a) was developed solely at private expense; (b) contains "restricted computer software" submitted with restricted rights in accordance with Section 52.227-19 (a) through (d) of the Commercial Computer Software - Restricted Rights Clause and its successors, and (c) in all respects is proprietary data belonging to Cabletron and/or its suppliers.

For Department of Defense units, the product is licensed with "Restricted Rights" as defined in the DoD Supplement to the Federal Acquisition Regulations, Section 52.227-7013 (c) (1) (ii) and its successors, and use, duplication, disclosure by the Government is subject to restrictions as set forth in subparagraph (c) (1) (ii) of the Rights in Technical Data and Computer Software clause at 252.227-7013. Cabletron Systems, Inc., 35 Industrial Way, Rochester, New Hampshire 03867

---

## TABLE OF CONTENTS

### APPENDIX A TABLE OF CONTENTS v

#### CHAPTER 1 INTRODUCTION

1.1	USING THIS MANUAL .....	1-1
1.2	GETTING HELP .....	1-2
1.3	SEH OVERVIEW .....	1-2
1.4	SEH FEATURES .....	1-3
1.5	STACKABLE CAPABILITIES.....	1-4
1.6	OPTIONAL FEATURES .....	1-4
1.7	RELATED MANUALS .....	1-5

#### CHAPTER 2 INSTALLATION REQUIREMENTS/SPECIFICATIONS

2.1	CABLE SPECIFICATIONS.....	2-1
2.1.1	HubSTACK Interconnect Cable Requirements.....	2-1
2.1.2	UTP and STP Cable Specifications for the Network Ports and EPIM-T Module.....	2-2
2.1.3	Multimode Fiber Optic Cable Specifications for the EPIM-F1 and EPIM-F2 Modules .....	2-4
2.1.4	Single Mode Fiber Optic Cable Specifications for the EPIM-F3 Module .....	2-5
2.1.5	Thin-net Network Requirements for the EPIM-C Mod- ule	2-6
2.1.6	AUI Cable Requirements for the EPIM-A and EPIM-X Modules.....	2-7
2.2	NETWORK PORT SPECIFICATIONS .....	2-7
2.2.1	SEH-22 and SEH-24 Network Port Specifications.....	2-8
2.2.2	SEH-32 and SEH-34 Network Port Specifications.....	2-8
2.3	EPIM SPECIFICATIONS .....	2-10
2.3.1	EPIM-T .....	2-10
2.3.2	<b>EPIM-F1/F2</b> .....	<b>2-11</b>
2.3.3	EPIM-F3 .....	2-12
2.3.4	EPIM-C .....	2-14
2.3.5	EPIM-A and EPIM-X (AUI Port).....	2-15
2.4	TRANSCEIVER REQUIREMENTS .....	2-16
2.5	OPERATING SPECIFICATIONS.....	2-16

# CONTENTS

---

## CHAPTER 3 INSTALLATION

3.1	UNPACKING THE SEH.....	3-1
3.2	INSTALLING THE SEH.....	3-1
3.2.1	Stacking the SEH .....	3-2
3.2.2	Attaching the Strain Relief Bracket.....	3-4
3.2.3	Rack Mounting the SEH .....	3-5
3.2.4	Wall Mounting the SEH.....	3-6
3.2.5	Free-Standing Installation.....	3-7
3.3	CONNECTING THE SEH TO THE POWER SOURCE .....	3-8

## CHAPTER 4 CONNECTING TO THE NETWORK

4.1	CONNECTING THE SEH TO THE NETWORK .....	4-1
4.1.1	Connecting Network Ports SEH-22 and SEH-24.....	4-1
4.1.2	Connecting Network Ports SEH-32 and SEH-34.....	4-3
4.1.3	Connecting a UTP Segment to an EPIM-T .....	4-4
4.1.4	Connecting a Fiber Optic Link Segment to an EPIM-F1, EPIM-F2, or EPIM-F34-5	
4.1.5	Connecting a Thin-Net Segment to an EPIM-C .....	4-8
4.1.6	Connecting an AUI Cable to an EPIM-A .....	4-10
4.1.7	Connecting an AUI Cable to an EPIM-X.....	4-11
4.2	FINISHING THE INSTALLATION.....	4-12

## CHAPTER 5 TROUBLESHOOTING

5.1	INSTALLATION CHECK-OUT .....	5-1
5.2	USING LANVIEW.....	5-2

## APPENDIX B TWISTED PAIR WIRING TABLES A-1

## CHAPTER 1

### INTRODUCTION

Welcome to the Cabletron Systems **SEH-22, SEH-24, SEH-32, and SEH-34 10BASE-T Stackable Hub User's Guide**. This manual explains installation instructions and provides reference information for the SEH-22, 24, 32, and 34.

***Note:** The term SEH (Stackable Ethernet Hub) is used throughout this manual when describing features and functions that are common to the SEH-22, 24, 32, and 34.*

#### 1.1 USING THIS MANUAL

Read through this manual completely to familiarize yourself with its content and to gain an understanding of the features and capabilities of the SEH. A general working knowledge of Ethernet and IEEE 802.3 type data communications networks and their physical layer components will be helpful when installing the SEH.

Chapter 1, **Introduction**, outlines the contents of this manual, briefly describes SEH features, and concludes with a list of related manuals.

Chapter 2, **Installation Requirements/Specifications**, describes installation requirements, network guidelines, and SEH operating specifications.

Chapter 3, **Installation**, contains instructions for installing your SEH as a stackable or stand-alone hub.

Chapter 4, **Connecting to the Network**, explains how to connect the SEH to the network using the various media types.

Chapter 5, **Troubleshooting**, describes how to use the LANVIEW LEDs to troubleshoot network problems.

Appendix A, **Twisted Pair Wiring Tables**, contains wiring pinouts for Punch Down Block applications.



# INTRODUCTION

## 1.2 GETTING HELP

If you need additional support related to the Cabletron Systems SEH, or if you have any questions, comments, or suggestions concerning this manual, contact Cabletron Systems Technical Support:

By phone ..... (603) 332-9400  
Monday-Friday; 8am - 8pm EST

By CompuServe® ..... GO CTRON from any ! prompt

By Internet mail ..... support@ctrn.com

## 1.3 SEH OVERVIEW

The 10BASE-T SEH is a non-intelligent repeating hub that provides front panel ports for network connections and rear panel HubSTACK Interconnect Bus ports for stackable connections.

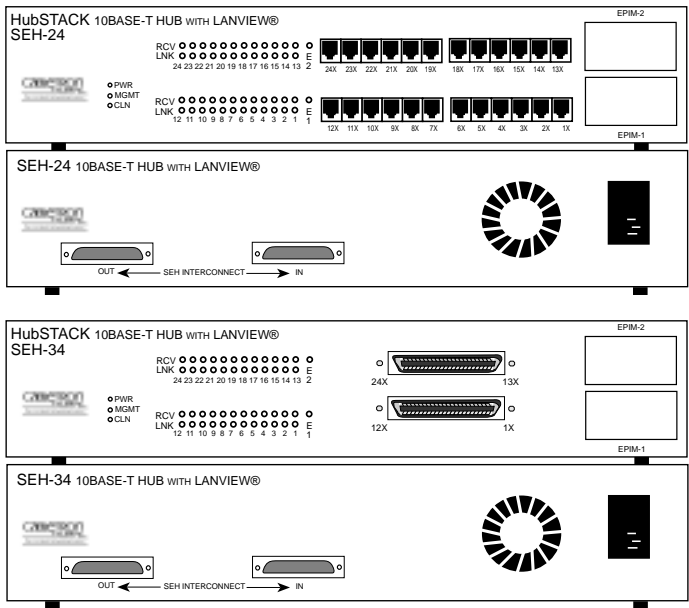

Figure 1-1. The SEH-24 and SEH-34

You can stack together up to five SEH hubs using Cabletron Systems' external HubSTACK Interconnect cables. If you want to add management to the stack, Cabletron Systems offers the MicroMMAC and the SEHI intelligent hubs. You can stack up to four SEHs with one intelligent hub. Stackable configurations let you maintain only one IEEE repeater hop while providing up to 130 Ethernet ports.

The SEH-22/24 and SEH-32/34 are functionally identical with the exception of the network ports:

- **SEH-22**, 12 RJ45 network ports and one EPIM port.
- **SEH-24**, 24 RJ45 network ports and two EPIM ports.
- **SEH-32**, one 50 pin Champ connector, providing 12 twisted pair segments, and one EPIM port.
- **SEH-34**, two 50 pin Champ connectors, providing 24 twisted pair segments, and two EPIM ports.

### 1.4 SEH FEATURES

#### **Repeater Functionality**

The SEH fully conforms to the IEEE 802.3 Repeater, AUI, and 10BASE-T specifications, and provides the flexibility to connect networks using IEEE 802.3, Ethernet Version 1 or Version 2 equipment. The SEH transmits re-timed data packets, regenerates the preamble, extends fragments, and arbitrates collisions.

The SEH automatically partitions problem segments, and reconnects repaired segments to the network. This feature minimizes the impact on network operation by isolating the problem segment. Only devices on the problem segment are affected. When the problem is solved, the SEH automatically reconnects the isolated segment to the network.

#### **Polarity Detection and Correction**

Each twisted pair port on the SEH incorporates a Polarity Detection and Correction feature that allows the SEH to pass data regardless of the polarity of the twisted pair segment's receive link. We do not recommend operating in this condition. If you discover this condition, remove the segment from the network and wire it correctly. This reduces the potential for problems if equipment changes are made.

# INTRODUCTION

---

## LANVIEW LEDs

Cabletron Systems' LANVIEW Status Monitoring and Diagnostics System is a troubleshooting tool that helps you diagnose power failures, collisions, cable faults, and link problems. The LANVIEW LEDs are conveniently located on the front panel.

## 1.5 STACKABLE CAPABILITIES

The SEH is a non-intelligent hub designed to be managed by either the Cabletron Systems SEHI intelligent hub or the Cabletron Systems MicroMMAC intelligent hub. Intelligent hubs serve as the logical “top” of the stack. They manage all SEH hubs in the stack providing full packet and error statistics for the entire stack, individual device, or individual port. You can stack together up to five SEHs for a non-managed stack or one intelligent hub and up to four SEHs for a managed stack. You can also add or remove hubs from the stack without having to power down.

## 1.6 OPTIONAL FEATURES

The following features are not included with the SEH but can be purchased separately from Cabletron Systems.

### Ethernet Port Interface Modules (EPIMs)

EPIMs let you expand your network through a variety of media. Cabletron offers the EPIMs shown in Table 1-1.

Table 1-1. EPIMs

EPIM	Media Type	Connector
EPIM-A	AUI	DB15 (Female)
EPIM-C	10BASE-2 Thin Coaxial	BNC
EPIM-T	10BASE-T Unshielded Twisted Pair	RJ45
EPIM-X	Standard Transceiver	DB15 (Male)
EPIM-F1	Multimode Fiber	SMA
EPIM-F2	Multimode Fiber	ST
EPIM-F3	Single Mode Fiber	ST

**Daughter Board Upgrade Kit**

You can upgrade the SEH-22 and the SEH-32 to 24 ports using the daughter board upgrade kit. The Cabletron part numbers for the upgrades are:

- SEH-22: 24PORT-UGKT-E
- SEH-32: 24PORT-UGKT-E 50P

**HubSTACK Interconnect Cables**

You need Cabletron's HubSTACK Interconnect cables to stack hubs together. Table 1-2 lists the part number and application for each cable.

Table 1-2. HubSTACK Interconnect Cables

<b>Part Number</b>	<b>Description</b>	<b>Application</b>
9380110	12" HubSTACK Interconnect Cable	SEH to SEH connections.
9380111	18" HubSTACK Interconnect Cable	SEHI or MicroMMAC to SEH connections.

**Rack Mount or Wall Mount Hardware**

You can install your SEH in a 19-inch rack or mount it on a wall. Cabletron offers an accessory package that includes brackets and mounting screws. The part number for the accessory package is SEH-ACCY-KIT.

**1.7 RELATED MANUALS**

Use the **SEHI-22/24 and SEHI-32/34 User's Guide** and the **MicroMMAC-22E/24E and MicroMMAC-32E/34E User's Guide** to supplement the procedures and other technical data provided in this manual. The procedures contained in these manuals are referenced where appropriate, rather than repeated in this manual.

## CHAPTER 2

### INSTALLATION REQUIREMENTS/SPECIFICATIONS

This chapter describes network guidelines, power requirements, and operating specifications for the SEH. Be sure to read this chapter before you install the SEH. Your network must meet the requirements and conditions specified in this chapter to obtain satisfactory performance from this equipment. Failure to follow these guidelines could result in poor network performance.

#### **2.1 CABLE SPECIFICATIONS**

The SEH network ports support both Shielded Twisted Pair (STP) or Unshielded Twisted Pair (UTP) cabling. The Ethernet Port Interface Modules (EPIMs) let you expand your network using UTP, STP, Multimode Fiber Optic, Single Mode Fiber Optic, or Thin Coaxial cabling. The rear panel Interconnect Bus Ports support Cabletron Systems' HubSTACK Interconnect cables for stackable applications.

Take care in planning and preparing the cabling and connections for your network. The quality of the connections and the length of cables are critical factors in determining the reliability of your network. The following sections describe specifications for each media type.

##### **2.1.1 HubSTACK Interconnect Cable Requirements**

You connect units in the stack with HubSTACK Interconnect cables. Refer to Chapter 1 for cable part numbers. The cables attach to the SEH's rear panel bus ports.

The rear panel of the SEH has an SEH Interconnect Bus Out Port (male connector) and an SEH Interconnect Bus In Port (female connector). The bus supports five stackable devices.

## **INSTALLATION REQUIREMENTS/SPECIFICATIONS**

---

### **2.1.2 UTP and STP Cable Specifications for the Network Ports and EPIM-T Module**

The device at the other end of the twisted pair segment must meet IEEE 802.3 10BASE-T specifications. When you connect a 10BASE-T Twisted Pair Segment to the SEH's 10BASE-T Twisted Pair Network Ports and EPIM-T module, your network must meet the following requirements:

#### **Length**

The IEEE 802.3 10BASE-T standard requires that 10BASE-T devices transmit over a **100** meter (328 foot) link using 22-24 AWG unshielded twisted pair wire. However, cable quality largely determines maximum link length. If you use high quality, low attenuation cable, you can achieve link lengths of up to 200 meters. Cable delay limits maximum link length to 200 meters, regardless of the cable type.

#### **Insertion Loss**

The maximum insertion loss allowed for a 10BASE-T link is 11.5 dB at all frequencies between 5.0 and 10 MHz. This includes the attenuation of the cables, connectors, patch panels, and reflection losses due to impedance mismatches in the link segment.

#### **Impedance**

Cabletron Systems 10BASE-T Twisted Pair products will work on twisted pair cable with 75 to 165 ohms impedance. Unshielded twisted pair cables typically have an impedance of between 85 to 110 ohms.

Shielded twisted pair cables, such as IBM Type 1 cable, can also be used. You should remember that the impedance of IBM Type 1 cable is typically 150 ohms. This increases the signal reflection caused by the cable, but since the cable is shielded, this signal reflection has little effect on the received signal's quality due to the lack of crosstalk between the shielded cable pairs.

#### **Jitter**

Intersymbol interference and reflections can cause jitter in the bit cell timing, resulting in data errors. A 10BASE-T link must not generate more than 5.0 nsec. of jitter. If your cable meets the impedance requirements for a 10BASE-T link, jitter should not be a concern.

### **Delay**

The maximum propagation delay of a 10BASE-T link segment must not exceed 1000 nsec. This 1000 nsec. maximum delay limits the maximum link segment length to no greater than 200 meters.

### **Crosstalk**

Crosstalk is caused by signal coupling between the different cable pairs contained within a multi-pair cable bundle. 10BASE-T transceivers are designed so that the user does not need to be concerned about cable crosstalk, provided the cable meets all other requirements.

### **Noise**

Noise can be caused by either crosstalk or externally induced impulses. Impulse noise may cause data errors if the impulses occur at very specific times during data transmission. Generally, the user need not be concerned about noise. If noise-related data errors are suspected, it may be necessary to either reroute the cable or eliminate the source of the impulse noise.

### **Temperature**

Multi-pair PVC 24 AWG telephone cables typically have an attenuation of approximately 8 to 10 dB/100m at 20°C (78°F). The attenuation of PVC insulated cable varies significantly with temperature. At temperatures greater than 40°C (104°F), we strongly recommend that you use plenum-rated cables to ensure that cable attenuation remains within specification.

## **INSTALLATION REQUIREMENTS/SPECIFICATIONS**

---

### **2.1.3 Multimode Fiber Optic Cable Specifications for the EPIM-F1 and EPIM-F2 Modules**

Table 2-1 shows Multimode Fiber Optic Cable specifications for the EPIM-F1 and EPIM-F2 modules.

Table 2-1. Multimode Fiber Optic Cable Specifications

<b>Cable Type</b>	<b>Attenuation</b>	<b>Maximum Cable Length</b>
50/125 $\mu\text{m}$	13.0 dB or less	The maximum allowable fiber optic cable length is 2 km (2187.2 yards). However, IEEE 802.3 specifications allow for a maximum of 1 km (1093.6 yards).
62.5/125 $\mu\text{m}$	16.0 dB or less	
100/140 $\mu\text{m}$	19.0 dB or less	

#### **Attenuation**

You must test the fiber optic cable with a fiber optic attenuation test set adjusted for an 850 nm wavelength. This test verifies that the signal loss in a cable is within an acceptable level. Table 2-1 shows the attenuation for each Multimode cable type.

#### **Fiber Optic Budget and Propagation Delay**

When determining the maximum fiber optic cable length, the fiber optic budget delay and total network propagation should be calculated and taken into consideration before fiber optic cable runs are incorporated in any network design.

Fiber optic budget is the combination of the optical loss due to the fiber optic cable, in-line splices, and fiber optic connectors.

Propagation delay is the amount of time it takes data to travel from the sending device to the receiving device. Total propagation delay allowed for the entire network is 25.6  $\mu\text{sec}$ , if the total propagation delay between any two nodes on the network exceeds 25.6  $\mu\text{sec}$ , then bridges should be used.



## 2.1.4 Single Mode Fiber Optic Cable Specifications for the EPIM-F3 Module

Table 2-2 shows Single Mode Fiber Optic Cable specifications for the EPIM-F3.

Table 2-2. Single Mode Fiber Optic Cable Specifications

Cable Type	Attenuation	Maximum Cable Length
8/125-12/125 $\mu\text{m}$	10.0 dB or less	The maximum allowable fiber optic cable length is 5 km (3.1 miles) with bridges at each segment end. However, IEEE 802.3 FOIRL specifications specify a maximum of 1 km (1093.6 yards).

### Attenuation

You must test the fiber optic cable with a fiber optic attenuation test set adjusted for an 1300 nm wavelength. This test verifies that the signal loss in a cable is 10.0 dB or less for any given single mode fiber optic link.

### Fiber Optic Budget and Propagation Delay

Fiber optic budget is the combination of the optical loss due to the fiber optic cable, in-line splices, and fiber optic connectors. When determining the maximum fiber optic cable length, the fiber optic budget (total loss of 10.0 dB or less between stations) and total network propagation delay should be calculated and considered before fiber optic cable runs are incorporated in any network design.

Propagation delay is the amount of time it takes data to travel from the sending device to the receiving device. Total propagation delay allowed for the entire network is 25.6  $\mu\text{sec}$ , if the total propagation delay between any two nodes on the network exceeds 25.6  $\mu\text{sec}$ , then bridges should be used.

## **INSTALLATION REQUIREMENTS/SPECIFICATIONS**

---

### **2.1.5 Thin-net Network Requirements for the EPIM-C Module**

When you connect a thin-net segment to the SEH (via an EPIM-C), your network must meet the following requirements:

#### **Cable Type**

50 ohm RG-58A/U type coaxial cable must be used when making up a thin-net cable segment.

#### **Length**

The thin-net segment must be no longer than 185 meters.

#### **Terminators**

A 50 ohm terminator must be connected to the far end of each thin-net segment.

#### **Connectors**

A maximum of 29 tee-connectors may be used throughout the length of cable segment for host connections. If an excessive number of barrel connectors are used within the cable segment, such as finished wall plates with BNC feed-throughs, then a reduced number of host connections may be required. For special network design, contact Cabletron Systems Technical Support.

#### **Grounding**

For safety, ground only **one** end of a thin-net segment. Do NOT connect EPIM BNC ports to earth ground.

**Warning:** *Connecting a thin-net segment to earth ground at more than one point could produce dangerous ground currents.*

### **2.1.6 AUI Cable Requirements for the EPIM-A and EPIM-X Modules**

When you connect an external network segment to the SEH (via an EPIM-A or EPIM-X), the AUI cable must meet the following requirements:

#### **AUI Cable**

The AUI cable connecting the module to a device must be IEEE 802.3 type cable.

#### **Length**

The AUI Cable must not exceed 50 meters in length. If 28 AWG thin office drop AUI cable is used, then the maximum cable length is limited to 50 feet (15.24 meters).

#### **Grounding**

The connector shell of the EPIM-A and the EPIM-X are connected to ground.

### **2.2 NETWORK PORT SPECIFICATIONS**

The SEH-22 and SEH-24 network ports are shielded RJ45 connectors that support both STP and UTP cabling. The SEH-32 and SEH-34 provide a 50 pin Champ style connector for network connections. The following sections provide specifications for each SEH model.

# INSTALLATION REQUIREMENTS/SPECIFICATIONS

## 2.2.1 SEH-22 and SEH-24 Network Port Specifications

The SEH-22 and SEH-24 provide RJ45 connections for network connections. Figure 2-1 shows the RJ45 pinouts.

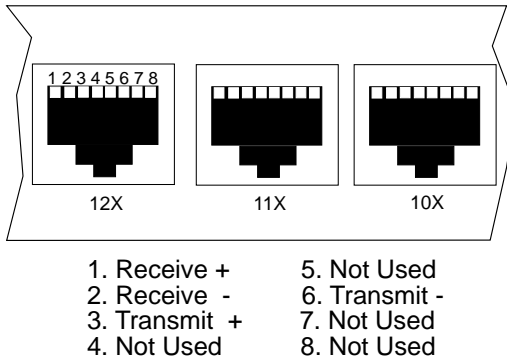

Figure 2-1. RJ45 Network Ports

## 2.2.2 SEH-32 and SEH-34 Network Port Specifications

The SEH-32 and SEH-34 provide 50 pin Champ connectors for network connections as shown in Figure 2-2. Table 2-3 shows the pinouts for the Champ connector.

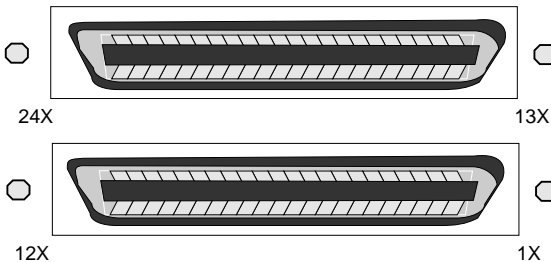

Figure 2-2. SEH-34 Network Ports

## INSTALLATION REQUIREMENTS/SPECIFICATIONS

Table 2-3. Champ Connector Pinouts

### 50 Pin Champ Connector

Pin	Signal	Wire Color	Pin	Signal	Wire Color
1	RX 1-	Blue/White	26	RX 1+	White/Blue
2	TX 1-	Orange/White	27	TX 1+	White/Orange
3	RX 2-	Green/White	28	RX 2+	White/Green
4	TX 2-	Brown/White	29	TX 2+	White/Brown
5	RX 3-	Gray/White	30	RX 3+	White/Gray
6	TX 3-	Blue/Red	31	TX 3+	Red/Blue
7	RX 4-	Orange/Red	32	RX 4+	Red/Orange
8	TX 4-	Green/Red	33	TX 4+	Red/Green
9	RX 5-	Brown/Red	34	RX 5+	Red/Brown
10	TX 5-	Gray/Red	35	TX 5+	Red/Gray
11	RX 6-	Blue/Black	36	RX 6+	Black/Blue
12	TX 6-	Orange/Black	37	TX 6+	Black/Orange
13	RX 7-	Green/Black	38	RX 7+	Black/Green
14	TX 7-	Brown/Black	39	TX 7+	Black/Brown
15	RX 8-	Gray/Black	40	RX 8+	Black/Gray
16	TX 8-	Blue/Yellow	41	TX 8+	Yellow/Blue
17	RX 9-	Orange/Yellow	42	RX 9+	Yellow/Orange
18	TX 9-	Green/Yellow	43	TX 9+	Yellow/Green
19	RX 10-	Brown/Yellow	44	RX 10+	Yellow/Brown
20	TX 10-	Gray/Yellow	45	TX 10+	Yellow/Gray
21	RX 11-	Blue/Violet	46	RX 11+	Violet/Blue
22	TX 11-	Orange/Violet	47	TX 11+	Violet/Orange
23	RX 12-	Green/Violet	48	RX 12+	Violet/Green
24	TX 12-	Brown/Violet	49	TX 12+	Brown
25	N/C	Gray/Violet	50	N/C	Violet/Gray

# INSTALLATION REQUIREMENTS/SPECIFICATIONS

## 2.3 EPIM SPECIFICATIONS

EPIMs let you connect the SEH to the main network using different media types. Cabletron Systems offers a variety of EPIMs. The following sections explain specifications for each EPIM.

### 2.3.1 EPIM-T

The EPIM-T is an RJ45 connector supporting UTP cabling. It has an internal Cabletron Systems TPT-T™ 10BASE-T Twisted Pair Transceiver.

The slide switch on the EPIM-T determines the cross-over status of the cable pairs. If the switch is on the X side, the pairs are internally crossed over. If the switch is on the = side, the pairs are not internally crossed over. Figure 2-3 shows the pinouts for the EPIM-T in both cross-over positions.

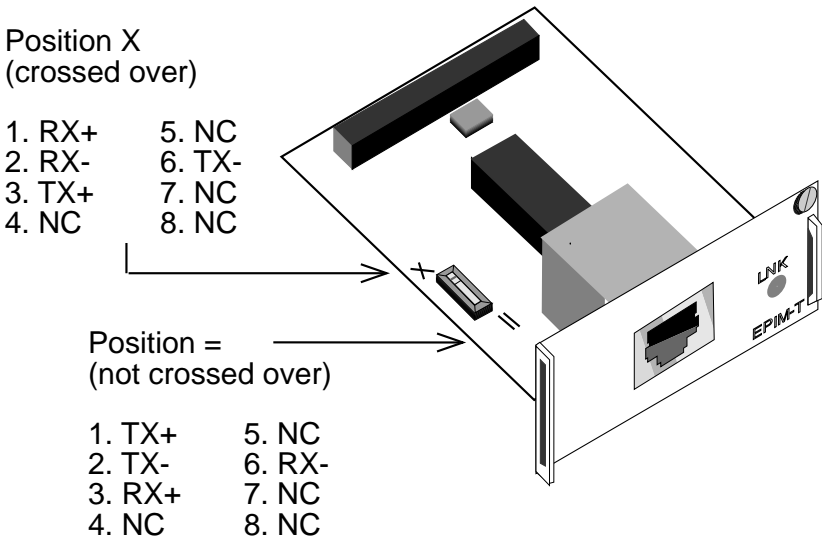

Figure 2-3. EPIM-T Pinouts

## INSTALLATION REQUIREMENTS/SPECIFICATIONS

### 2.3.2 EPIM-F1/F2

The EPIM-F1 and EPIM-F2 shown in Figure 2-4 support Multimode Fiber Optic cabling. Each EPIM has an internal Cabletron Systems FOT-F™ Fiber Optic Transceiver. The EPIM-F1 is equipped with SMA Connectors and the EPIM-F2 is equipped with ST Connectors. Specifications for the EPIMs are listed below.

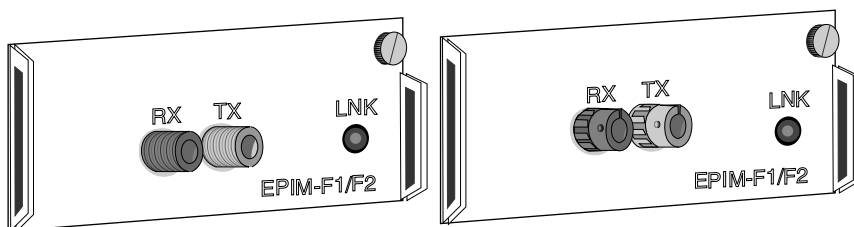

Figure 2-4. EPIM-F1 and EPIM-F2

Parameter	Typical Value	Worst Case	Worst Case Budget	Typical Budget
Receive Sensitivity:	-30.5 dBm	-28.0 dBm	—	—
Peak Input Power:	-7.6 dBm	-8.2 dBm	—	—
<b>Transmitter Power</b>				
50/125 μm fiber:	-13.0 dBm	-15.0 dBm	13.0 dB	17.5 dB
62.5/125 μm fiber:	-10.0 dBm	-12.0 dBm	16.0 dB	20.5 dB
100/140 μm fiber:	-7.0 dBm	-9.0 dBm	19.0 dB	23.5 dB
Error Rate:	Better than 10 <sup>-10</sup>			

**Note:** The transmitter power levels and receive sensitivity levels listed are Peak Power Levels after optical overshoot. A Peak Power Meter must be used to correctly compare the values given above to those measured on any particular port. If Power Levels are being measured with an Average Power Meter, then 3 dBm must be added to the measurement to correctly compare those measured values to the values listed (i.e. -30.5 dBm peak=-33.5 dBm average).

## INSTALLATION REQUIREMENTS/SPECIFICATIONS

---

### 2.3.3 EPIM-F3

The EPIM-F3 shown in Figure 2-5 supports Single Mode Fiber Optic cabling. It has an internal Cabletron Systems FOT-F™ Fiber Optic Transceiver and is equipped with ST Connectors. Specifications for the EPIM-F3 are listed below.

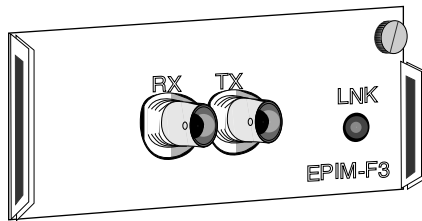
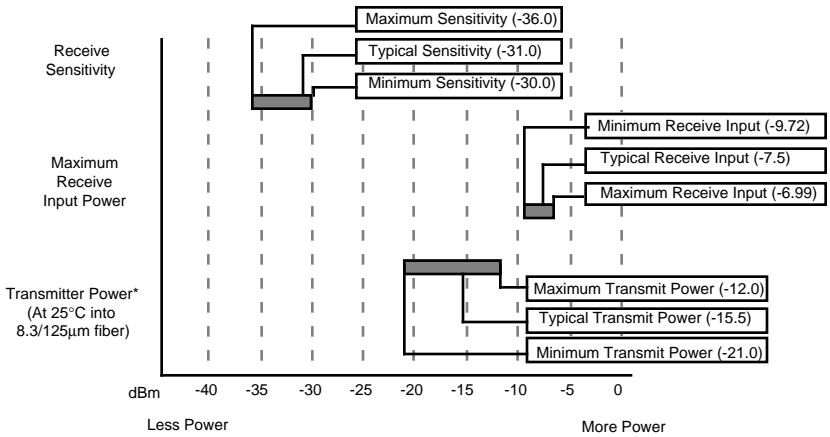

Figure 2-5. EPIM-F3

**Note:** *Transmitter Power decreases as temperatures rise and increases as temperatures fall. Use the Output Power Coefficient to calculate increased or decreased power output for your operating environment. For example, the typical power output at 25° C is -16.4 dBm. For a 4° C temperature increase, multiply the typical coefficient (-0.15 dBm) by four and add the result to typical output power ( $4 \times -0.15 \text{ dBm} + -16.4 = -17.0$ ).*



# INSTALLATION REQUIREMENTS/SPECIFICATIONS



\* Transmit Power Coefficient (See Note Below)

	Typical Power	Minimum Power	Maximum Power
	-0.15dBm/°C	-0.12 dBm/°C	-0.18 dBm/°C

Parameter	Typical	Minimum	Maximum
Transmitter Peak Wave Length	1300 nm	1270 nm	1330 nm
Spectral Width	60 nm	-	100 nm
Rise Time/ Fall Time	3.0 nsec 2.5 nsec	2.7 nsec 2.2 nsec	5.0 nsec 5.0 nsec
Duty Cycle	50.1%	49.6%	50.7%
Bit Error Rate:	Better than 10 <sup>-10</sup>		

**Note:** The transmitter power levels given above are Peak Power Levels after optical overshoot. You must use a Peak Power Meter to correctly compare the values given above to those measured on any particular port. If you are measuring power levels with an Average Power Meter, add 3 dBm to the average power measurement to correctly compare the average power values measured to the values listed above (i.e. -33.5 dBm average + 3 dB = -30.5 dBm peak).

## INSTALLATION REQUIREMENTS/SPECIFICATIONS

---

### 2.3.4 EPIM-C

The EPIM-C supports thin-net coaxial cabling and is equipped with an internal Cabletron Systems TMS-3™ Transceiver. You can use the TERM switch on the front of the EPIM-C to set the internal 50 Ohm terminator. This eliminates the need to connect the port to a tee-connector and terminator. Figure 2-6 shows the setting for the terminator switch.

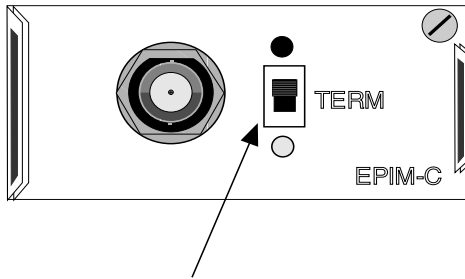

Internal Termination Switch  
● = On (internally terminated)  
○ = Off (need external termination)

Figure 2-6. EPIM-C

#### Connector Type

BNC receptacle, with gold center contact, for use with BNC type tee-connectors and RG-58 thin-net cable.

#### Grounding

For safety, only one end of a thin-net segment should be connected to earth ground. Connection to earth ground at more than one point on the segment may cause dangerous ground currents.

The BNC port of the Coaxial Interface Modules is not connected to earth ground.

## 2.3.5 EPIM-A and EPIM-X (AUI Port)

The EPIM-A is a DB15 female connector used to attach segments to an external transceiver. The EPIM-X is equipped with dual internal transceivers. It has a DB15 male connector used to attach segments to an AUI cable. Figure 2-7 shows both modules.

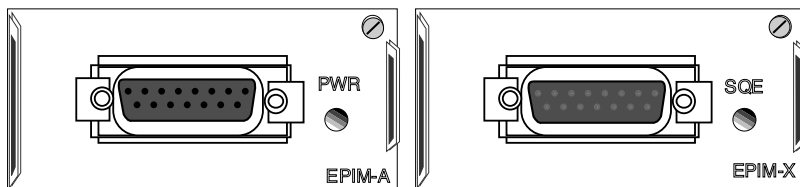

Figure 2-7. The EPIM-A and EPIM-X

### DB15 Pinouts

Pin 1	Logic Ref.	9	Collision -
2	Collision +	10	Transmit -
3	Transmit	11	Logic Ref.
4	Logic Ref.	12	Receive -
5	Receive +	13	Power (+12Vdc)
6	Power Return	14	Logic Ref.
7	No Connection	15	No Connection

Connector Shell: Protective Ground

# **INSTALLATION REQUIREMENTS/SPECIFICATIONS**

---

## **2.4 TRANSCEIVER REQUIREMENTS**

When you connect an external network segment, via a transceiver, to the SEH with an EPIM-A, the following requirements must be met:

- The transceiver or Ethernet Device to which the module will be connected must meet IEEE 802.3 standards, and/or Ethernet Version 1.0 or Version 2.0 standards.
- The Signal Quality Error (SQE) test function on the transceiver must be disabled if you connect it to a repeater or to an Ethernet Version 1.0 device. In addition, some Version 2.0 equipment does not support the SQE test. Devices that do not support SQE test interpret the SQE test pulse as a collision.

## **2.5 OPERATING SPECIFICATIONS**

This section describes the operating specifications for the SEH. Cabletron Systems reserves the right to change these specifications at any time without notice.

### **GENERAL**

---

#### **Delay Times (Start of Packets):**

Twisted Pair to EPIM- A	1.10 microseconds
Twisted Pair to Twisted Pair	1.00 microseconds
EPIM-A to Twisted Pair	1.00 microseconds

#### **Delay Times (JAM):**

Twisted Pair to EPIM-A	960 nanoseconds
------------------------	-----------------

#### **Preamble:**

Input:	Minimum of 40 bits required
Output:	64 bits min. (last 2 bits are 1, 1)

## INSTALLATION REQUIREMENTS/SPECIFICATIONS

<b>JAM Output:</b>	Collisions are propagated through the network using the JAM signal of an alternating pattern of 1's and 0's in accordance with 802.3 specifications for a repeater unit.
<b>Fragment Extension:</b>	Packet fragments are extended to a minimum of 96 bits using the JAM [1,0].
<b>Fault Protection:</b>	Each segment will disconnect itself from the other segments if 32 consecutive collisions occur, or if the collision detector of a segment is on for longer than approximately 110 $\mu$ s. This fault protection will reset automatically after one packet is transmitted/received onto the fault protected segment without causing a collision.

## POWER SUPPLY REQUIREMENTS

**Note:** The SEH has a universal power supply. This unit allows you to use an input power from 90 to 264 VAC, 47-63 Hz.

The power supply has two outputs of +5 volts and +12 volts. The maximum output power is 20 watts and the minimum efficiency is 65% under all conditions of line at full load. The minimum and maximum load current from each output is shown below.

<b><u>Output</u></b>	<b><u>Min. Load</u></b>	<b><u>Max. Load</u></b>	<b><u>Max Power</u></b>
+5 Volts	0.50 Amps	3.0 Amps	15 Watts
+12 Volts	0.05 Amps	1.0 Amps	12 Watts

## **INSTALLATION REQUIREMENTS/SPECIFICATIONS**

---

### **ENVIRONMENTAL REQUIREMENTS**

---

Operating Temperature:	+5° to +50° C
Non-operating Temperature:	-30° to +90° C
Operating Humidity:	5 to 95% (non-condensing)

### **SAFETY**

---

This unit meets the safety requirements of UL 1950, CSA C22.2 No. 950, and EN 60950; the EMI requirements of FCC Class A and EN 55022 Class A; and the EMC requirements of EN 50082-1.

**Warning:** *It is the responsibility of the person who sells the system to which the SEH will be a part to ensure that the total system meets allowed limits of conducted and radiated emissions.*

### **PHYSICAL**

---

Dimensions:	2.8H x 17.0W x 8.0D inches (7.2 x 43.6 x 20.5 cm)
Weight:	4.9 lbs
Predicted MTBF:	SEH-22/32: 753,629 hours SEH-24/34: 847,921 hours

## CHAPTER 3

### INSTALLATION

This chapter outlines the procedure for installing your SEH and connecting it to a network. You can install the SEH as a stackable or stand-alone device. Ensure that your network meets the guidelines and requirements outlined in Chapter 2, **Installation Requirements/Specifications**, before installing the SEH.

#### 3.1 UNPACKING THE SEH

Unpack the SEH as follows:

1. Remove the shipping material covering the SEH in the shipping box.
2. Carefully remove the SEH from the shipping box.
3. Remove the SEH from the protective plastic bag and set it aside to prevent damage.
4. Visually inspect the SEH. If there are any signs of damage, contact Cabletron Systems Technical Support immediately.

#### 3.2 INSTALLING THE SEH

You can install the SEH to your network as a stackable or stand-alone hub. If you want to install the SEH on a wall or a 19-inch rack, Cabletron Systems offers an accessory kit that includes Rack Mount Brackets, Wall Mount Brackets, Mounting Screws, and a Strain Relief Bracket. The accessory kit is not included with the SEH, but you can purchase it separately from Cabletron Systems as Part Number SEH-ACCY-KIT.

## INSTALLATION

---

Free-standing and shelf installations must be within in reach of the network cabling and meet the requirements listed below:

- A single phase 120Vac, 15A, grounded power receptacle must be located within 7 feet of the location.
- If you use a shelving unit, it must be able to support 30 pounds of static weight for each device in the stack.
- The temperature for the selected location must be maintained between 5° and 50°C, and fluctuate less than 10°C per hour.

The following sections provide instructions for stacking the SEH or installing it as a stand-alone device. Select one of the following subsections and perform the steps that are applicable to your installation needs.

### 3.2.1 Stacking the SEH

The rear panel of the SEH has an SEH Interconnect Bus In Port (female connector) and an SEH Interconnect Bus Out Port (male connector). You daisy chain units together using Cabletron Systems' HubSTACK Interconnect cables. Table 3-1 describes each cable.

Table 3-1. HubSTACK Interconnect Cables

<b>Part Number</b>	<b>Description</b>	<b>Application</b>
9380110	12" HubSTACK Interconnect Cable	SEH to SEH connections.
9380111	18" HubSTACK Interconnect Cable	SEHI or MicroMMAC to SEH connections.



To stack SEHs together, refer to Figure 3-1 and perform the following steps:

1. Attach the SEH HubSTACK Interconnect cable to the bus port labeled “OUT” on the rear panel of the SEH.
2. Attach the other end of SEH HubSTACK Interconnect cable to the bus port labeled “IN” on the rear panel of the SEH next in the stack.
3. Attach up to four SEH hubs in the stack repeating steps 1 and 2.

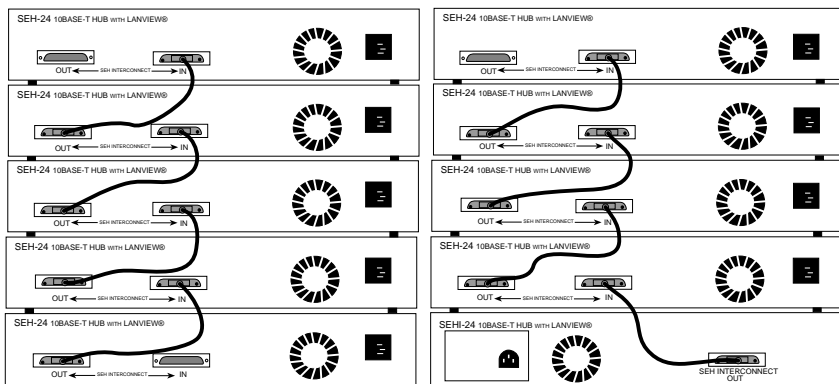

Figure 3-1. Stacking the SEH

To stack an SEH to an SEHI, refer to Figure 3-1 and perform the following steps:

1. Attach the SEHI HubSTACK Interconnect cable to the bus port labeled “OUT” on the rear panel of the SEHI.
2. Attach the other end of SEHI HubSTACK Interconnect cable to the bus port labeled “IN” on the rear panel of the SEH next in the stack.

# INSTALLATION

If you disconnect one end of a HubSTACK Interconnect cable and leave the other end attached to the hub, ensure that you disconnect the cable from the "OUT" port as shown in Figure 3-2. This ensures that the HubSTACK Interconnect cable is terminated properly.

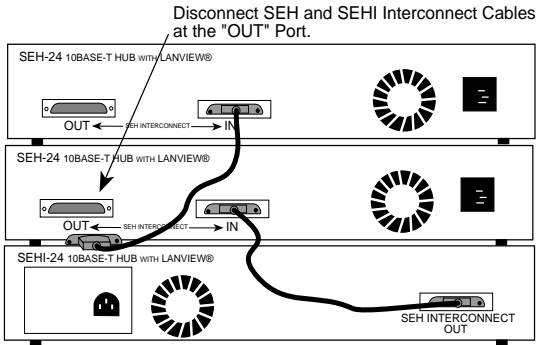

Figure 3-2. Disconnecting the HubSTACK Interconnect Cable

## 3.2.2 Attaching the Strain Relief Bracket

Attach the strain relief bracket to the front of the SEH as follows:

1. Locate the strain relief bracket and four 8-32 x 3/8" screws from the SEH-ACCY-KIT package.

**Warning:** Use of longer screws may cause damage to the unit or electrical shock.

2. Attach the strain relief bracket to the bottom of the SEH as shown in Figure 3-3.

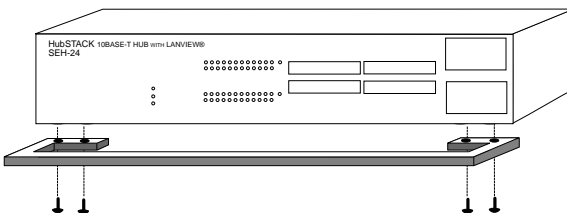
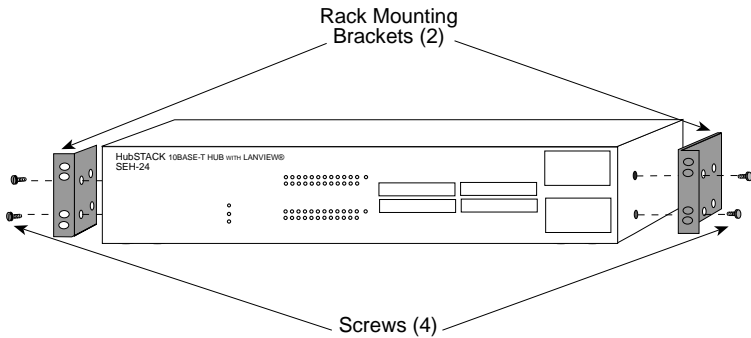

Figure 3-3. Attaching the Strain Relief

**3.2.3 Rack Mounting the SEH**

Refer to Figure 3-4 and perform these steps to install the SEH in a 19-inch rack.

1. Remove four cover screws (two from each side) located along the front edges of each side of the SEH.
2. Using the four cover screws removed in step 1, attach the rack mounting brackets to each end of the SEH.



**Figure 3-4. Installing the Rack Mount Brackets**

3. With the mounting brackets installed, position the SEH between the vertical frame members of the 19-inch rack and fasten it securely with the mounting screws as shown in Figure 3-5.

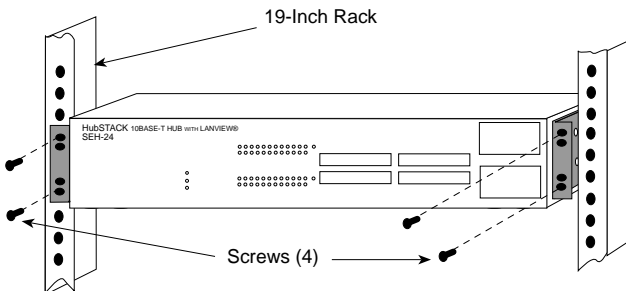

**Figure 3-5. Installing the SEH in the Rack**

# INSTALLATION

---

## 3.2.4 Wall Mounting the SEH

When you wall mount the SEH, the cable connections must face down. Refer to Figure 3-6 and perform the following steps to wall mount the SEH.

**Note:** 1/4-inch Molly screw anchors for wall mounting are not included with the SEH-ACCY-KIT package.

1. Use the supplied screws to attach the wall mounting brackets to the bottom of the SEH as shown in Figure 3-6. There are two brackets, one for each side.

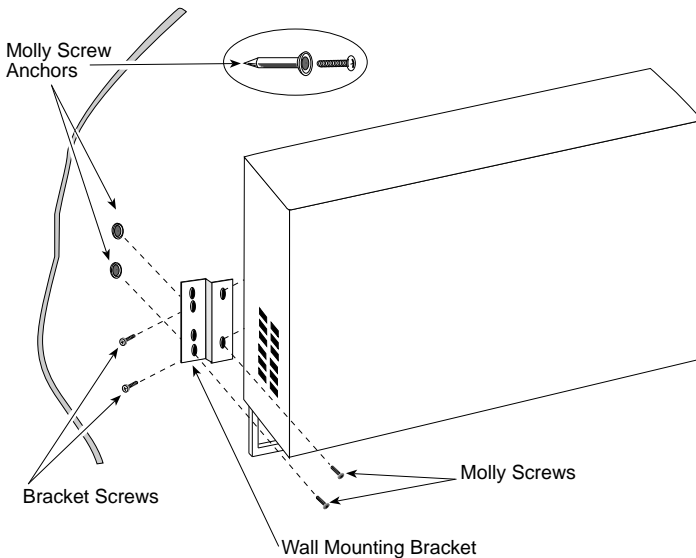

Figure 3-6. Installing the Wall Mounting Brackets

2. Select the wall location for the SEH within 7 feet of a power outlet.

**Warning:** There is a potential **SHOCK HAZARD** if there is electrical wiring within the wall that interferes with drilling for pilot holes. Select a wall location where drilling pilot holes for the Molly screws will not come in contact with electrical wiring in the wall.

3. You will need a pencil for this step. With the wall mounting brackets attached to the SEH, position the SEH against the wall where it will be permanently mounted with the network port facing down. Use the pencil to mark the wall location for the four pilot holes.
4. Set the SEH aside and carefully drill four 1/4" pilot holes, one for each of the Molly screw anchors and insert the four Molly screw anchors into the holes just drilled.
5. Tighten each of the anchor screws until the anchor expands holding the anchor firmly in the wall, then remove the screws completely.
6. Position the SEH on the wall over the anchors and reinstall the four anchor screws to attach the SEH to the wall, as shown in Figure 3-6. Tighten the four anchor screws.

### 3.2.5 Free-Standing Installation

For a free-standing shelf or tabletop installation, locate the SEH within 7 feet of its power source and with an unrestricted free surface area 21 inches wide, 18 inches deep and 6 inches high, as shown in Figure 3-7.

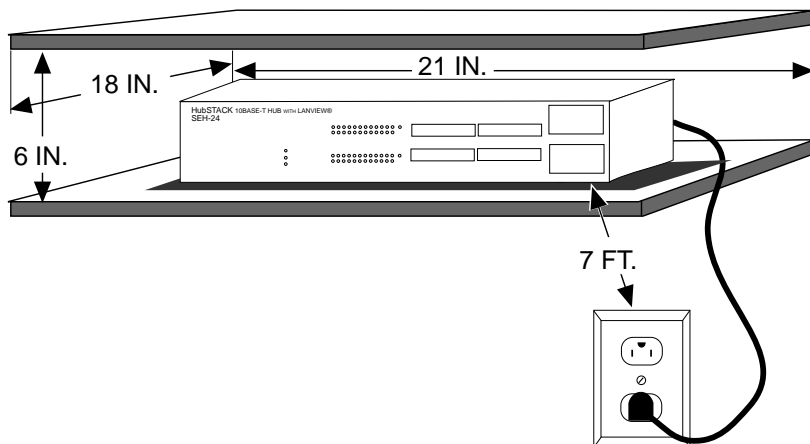

Figure 3-7. Shelf or Table-top Installation

## INSTALLATION

---

### 3.3 CONNECTING THE SEH TO THE POWER SOURCE

***Note:** The SEH has a universal power supply. This allows you to connect the SEH to power sources from 90 Vac to 264 Vac, 47-63 Hz.*

To connect the SEH to the power source:

1. Plug the power cord into the back panel of the SEH.
2. Plug the other end of the power cord into a grounded wall outlet.
3. Verify that the **PWR** LED is on, this indicates that the SEH is receiving power.

**CHAPTER 4****CONNECTING TO THE NETWORK**

This chapter outlines the procedure for connecting your SEH to a network. Ensure that your network meets the guidelines and requirements outlined in Chapter 2, **Installation Requirements/Specifications**, before installing the SEH.

**4.1 CONNECTING THE SEH TO THE NETWORK**

The procedure for connecting network segments to the SEH varies depending on the media and ports being connected. Refer to the following list and perform the procedure described in the subsections that apply to your SEH:

- Network Ports SEH-22/24 4.1.1
- Network Ports SEH-32/34 4.1.2
- EPIM-T 4.1.3
- EPIM-F1, F2, F3 4.1.4
- EPIM-C 4.1.5
- EPIM-A 4.1.6
- EPIM-X 4.1.7

Prior to connecting the network cabling check the connectors for the proper pinouts as shown in Chapter 2.

**4.1.1 Connecting Network Ports SEH-22 and SEH-24**

You attach unshielded twisted pair segments to the RJ45 Network Ports on the front panel of the SEH. Each twisted pair port on the SEH incorporates a Polarity Detection and Correction feature. The Polarity Detection and Correction feature allows the SEH to pass data regardless of the polarity of the twisted pair segment's receive link. Operating in this condition is not recommended and if this condition is discovered, the segment should be removed from the network and wired correctly by a technician.

## CONNECTING TO THE NETWORK

---

To connect twisted pair segments to the SEH:

1. Insert the RJ45 connector from each twisted pair segment into the desired network port on the SEH. See Figure 4-1.

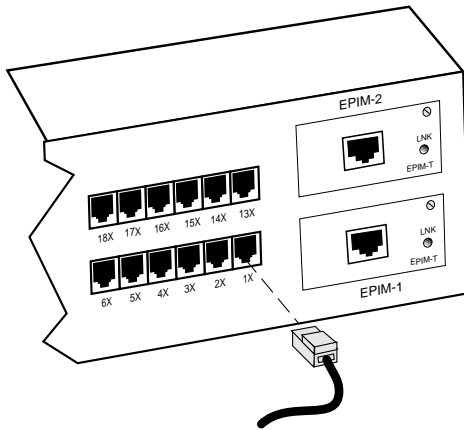

Figure 4-1. SEH-22/24 Network Ports

2. Check that the applicable **LNK** LED for the port is on. If the LED is not on, perform each of the following steps until it is:
  - a. Check that the 10BASE-T device at the other end of the twisted pair segment is powered up.
  - b. Verify that the RJ45 connector on the twisted pair segment has the proper pinouts. Check the cable for continuity.
  - c. Check that the twisted pair connection meets dB loss and cable specifications outlined Chapter 2.

If a link still has not been established, contact Cabletron Systems Technical Support.



### 4.1.2 Connecting Network Ports SEH-32 and SEH-34

The SEH-32 has a 50-pin Champ connector, while the SEH-34 has two 50-pin Champ connectors. This configuration of the SEH allows you to run a 50-pin feeder cable from the SEH to a punch down block. Each Champ connector supports 12 10BASE-T, twisted pair segments.

**Note:** Refer to **Appendix A** for information about wiring the SEH to a punch down block.

To connect the SEH into an existing twisted pair wiring system:

1. Connect a 50-pin feeder cable to the Champ connector on the SEH as shown in Figure 4-2.

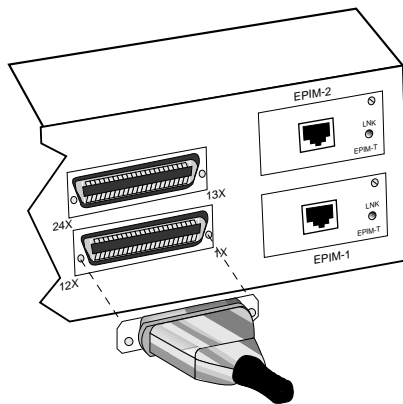

Figure 4-2. SEH-32/34 Network Ports

2. Attach the feeder cable to the punch down block, or patch panel.

In most cases, you can connect the feeder cable directly to a Champ connector located on the punch down block. If not, you must wire the feeder cable to the punch down block using the punch down information in Appendix A.

3. At the device end of a segment, attach the segment to a 10BASE-T compliant Ethernet device.

## CONNECTING TO THE NETWORK

4. Check that the link LED on the 10BASE-T Ethernet device and the applicable **LNK** LED on the SEH are on. If the LEDs are not on, perform each of the following steps until the LEDs are on:
  - a. Check that the 10BASE-T device and the SEH have power.
  - b. Verify the cabling between the SEH and the 10BASE-T device.
  - c. Check the cable for continuity.

If a link has not been established, contact Cabletron Systems Technical Support.

### 4.1.3 Connecting a UTP Segment to an EPIM-T

Before connecting a segment to the EPIM-T, check each end of the segment to determine if the wires have been crossed-over for the proper connection. If the wires do not cross over, use the switch on the EPIM-T to internally cross over the RJ45 port. Refer to Figure 4-3 to properly set the EPIM-T cross-over switch.

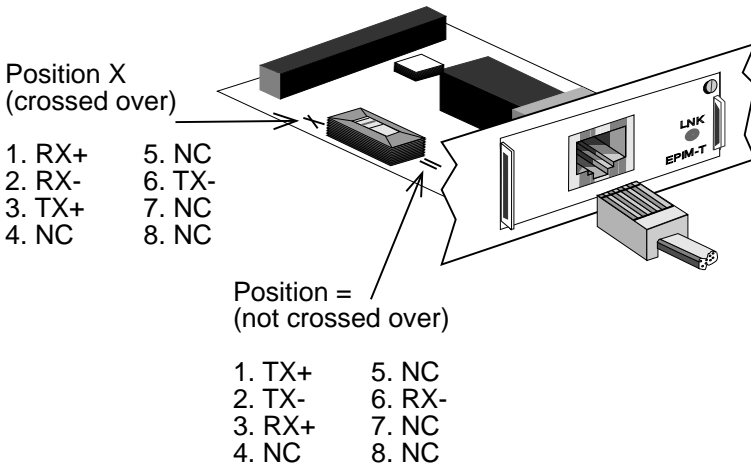

Figure 4-3. EPIM-T Cross-over Switch

To connect an EPIM-T to a Twisted Pair Segment:

1. Insert the RJ45 connector on the twisted pair segment into the RJ45 port on the EPIM. See Figure 4-3.
2. Check that the EPIM's **LNK** LED is on. If the LED is not on, perform each of the following steps until it is:
  - a. Check that the 10BASE-T device at the other end of the twisted pair segment is powered up.
  - b. Verify that the RJ45 connector on the twisted pair segment has the proper pinouts.
  - c. Check the cable for continuity.
  - d. Check that the twisted pair connection meets dB loss and cable specifications outlined in Chapter 2.
  - e. Check that the crossover switch is in the correct position.

If a link still has not been established, contact Cabletron Systems Technical Support.

### **4.1.4 Connecting a Fiber Optic Link Segment to an EPIM-F1, EPIM-F2, or EPIM-F3**

When connecting a fiber optic link segment to an EPIM-F1, F2, or F3 keep the following in mind:

- If you are connecting a fiber optic link segment with SMA 906 connectors to an EPIM-F1 with SMA ports, ensure that half alignment sleeves are in place on each connector. A full alignment sleeve will damage the receive port. SMA 905 connectors do not need alignment sleeves.
- If you are connecting a fiber optic link segment with ST connectors to an EPIM-F2 /F3 with ST ports, keep in mind that ST connectors attach to ST ports much like BNC connectors attach to BNC ports. Insert the connector into the port with the alignment key on the connector inserted into the alignment slot on the port. The connector is then turned to lock it down.

## CONNECTING TO THE NETWORK

---

- The physical communication link consists of two strands of fiber optic cabling: the Transmit (TX) and the Receive (RX). The Transmit strand from the applicable port on the module will be connected to the Receive port of a fiber optic Ethernet device at the other end of the segment. For example, TX of the applicable port on the module will go to RX of the other fiber optic device. The Receive strand of the applicable port on the module will be connected to the Transmit port of the fiber optic Ethernet device. For example, RX of the applicable port on the module will go to TX of the other fiber optic device.

We recommend that you label the fiber optic cable to indicate which fiber is Receive and which is Transmit. When you buy fiber optic cable from Cabletron Systems, it is labeled so that: at one end of the cable, one fiber is labeled 1, and the other fiber is labeled 2. This pattern is repeated at the other end of the cable. If you did not purchase your cable from Cabletron Systems, be sure you label your cable as described above.

***Caution:*** Do not touch the ends of the fiber optic strands, and do not let the ends come in contact with dust, dirt, or other contaminants. Contamination of the ends can cause problems in data transmissions. If the ends become contaminated, clean them with alcohol using a soft, clean, lint free cloth.

To connect a fiber optic link segment to an EPIM-F1, EPIM-F2, or EPIM-F3:

1. Remove the protective plastic covers from the fiber optic ports on the applicable port on the module and from the ends of the connectors on each fiber strand.
2. Attach the fiber labeled 1 to the applicable receive port, labeled **RX**, on the module. See Figure 4-4.

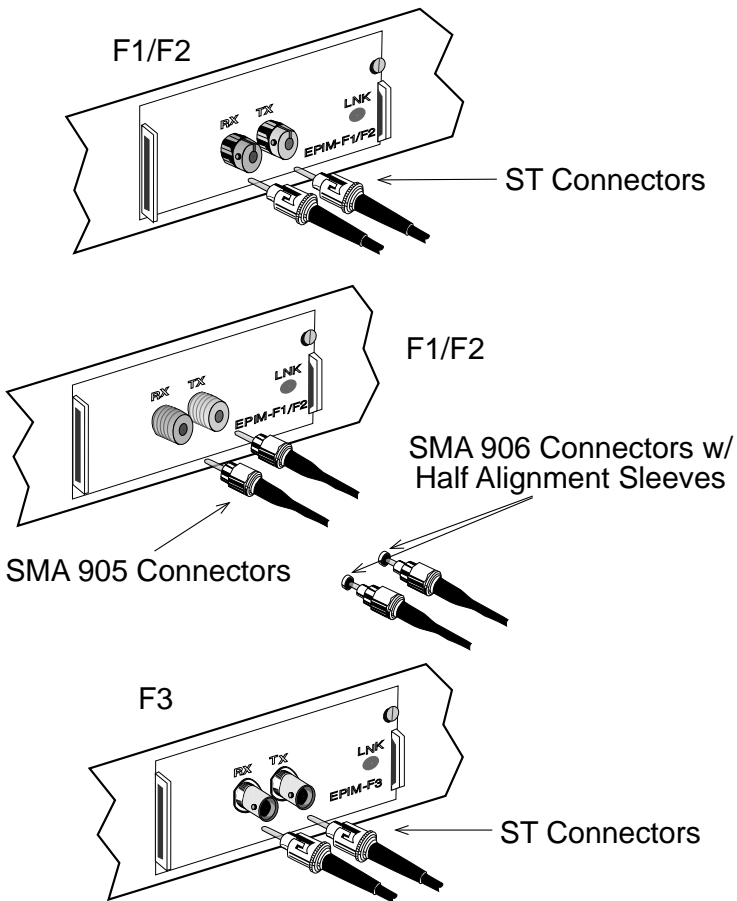

Figure 4-4. The EPIM-F1, EPIM-F2 and EPIM-F3

3. Attach the fiber labeled 2 to the applicable transmit port labeled **TX**, on the module.
4. At the other end of the fiber optic cable, attach the fiber labeled 1 to the transmit port of the device.
5. Attach the fiber labeled 2 to the receive port.

## CONNECTING TO THE NETWORK

---

6. Check that the EPIM's **LNK** LED is on. If the LED is not on, perform the following steps until it is:
  - a. Check that the power is turned on for the device at the other end of the link.
  - b. Verify proper “cross-over” of fiber strands between the applicable port on the module and the fiber optic device at the other end of the fiber optic link segment.
  - c. Verify that the fiber connection meets the dB loss specifications outlined in Chapter 2.

If a link still has not been established, contact Cabletron Systems Technical Support.

### 4.1.5 Connecting a Thin-Net Segment to an EPIM-C

To connect a thin-net segment to an EPIM-C, refer to Figure 4-5 and perform the following steps:

1. Set the Internal Termination Switch to the right of the port and labeled **TERM** to:
  - The on position (•) if the thin-net segment connected directly to the port will be internally terminated at the port.
  - The off position (o) if the thin-net segment will not be terminated at the port or externally terminated.
2. If the Internal Termination switch is in the On position, connect the thin-net segment directly to the BNC port as shown in Figure 4-5.
3. If the Internal Termination switch is in the Off position:
  - a. Attach a BNC tee-connector to the BNC port on the module.
  - b. Attach the thin-net segment to one of the female connectors on the tee-connector.

**Note:** You must terminate each segment attached to the tee-connector. If you do not attach a segment to one of the female connections on the tee-connector, then a terminator must be placed on that connection.

- c. Attach another thin-coax segment or a terminator to the other female connector on the tee-connector.

When internal termination switch is set to off (○):

Connect BNC tee-connector to port.

Attach a terminator or terminated thin-net segment to one female connector of tee-connector.

Connect a terminated thin-net segment to other female connector of tee-connector.

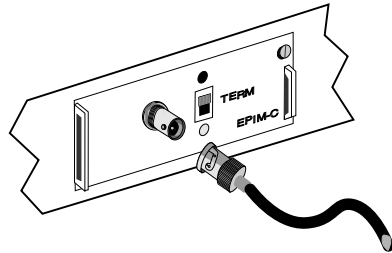

Attach thin-net segment directly to BNC connector when internal termination switch is set to on (●).

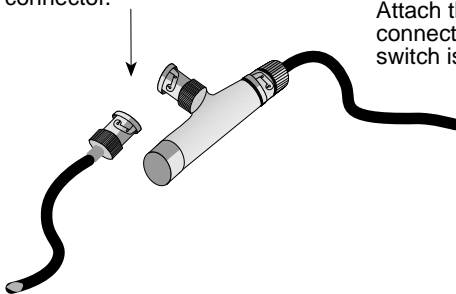

Figure 4-5. The EPIM-C

## CONNECTING TO THE NETWORK

---

### 4.1.6 Connecting an AUI Cable to an EPIM-A

**Caution:** Ensure that the external transceiver to which the SEH will be connected does not have the signal quality error (SQE or “heartbeat”) test function enabled. The SEH will not operate if the transceiver has the SQE test function enabled, and the network will be unusable. Refer to the applicable transceiver manual.

To connect an EPIM-A to an external network segment:

1. Attach an external transceiver to the network segment that will be connected to the AUI port. Refer to the applicable transceiver manual.
2. Attach an AUI cable, no longer than 50 meters in length, to the transceiver connected to the network in step 1.
3. Connect the AUI cable to the AUI port located on the EPIM-A. See Figure 4-6.
4. Lock the AUI connector into place using the connector slide latch.

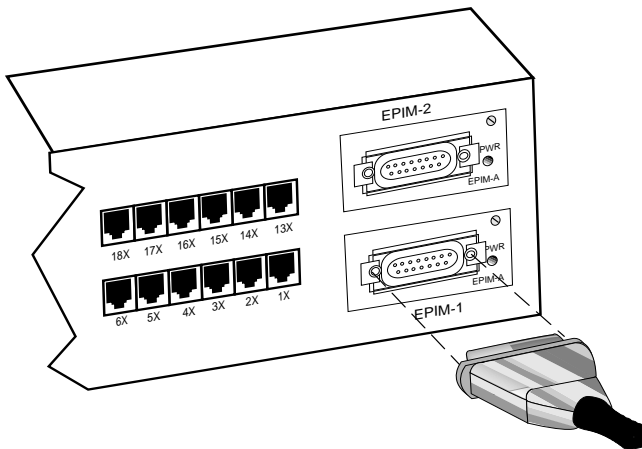

Figure 4-6. The EPIM-A



5. Check that the **PWR** LED on the EPIM-A is on. If the LED is not on, contact Cabletron Systems Technical Support.
6. If the **PWR** LED is on with the AUI cable disconnected, continue with the following checks:
  - a. Check the AUI connections for proper pinouts. The pinouts for the transceiver connection are listed in Chapter 2.
  - b. Check the cable for continuity.
  - c. Reconnect the AUI cable to the SEH and the device.

If the LED is still not on after reconnecting the segment, contact Cabletron Systems Technical Support.

### 4.1.7 Connecting an AUI Cable to an EPIM-X

**Caution:** *The signal quality error (SQE) switch remains in the OFF position for most network connections. However, some Data Terminal Equipment (DTE) requires SQE. Refer to your DTE manual for SQE requirement information.*

To connect an EPIM-X to a device not requiring SQE:

1. Check that the **SQE** LED on the EPIM-X is off. If the **SQE** LED is on, check the position of the SQE switch.

**Note:** *If the SQE light remains on, even though the SQE switch is in the OFF position, contact Cabletron Technical Support.*

2. Attach one end of an AUI cable, no longer than 50 meters in length, to the port located on the EPIM-X (Figure 4-7) and the other end to the intended node.

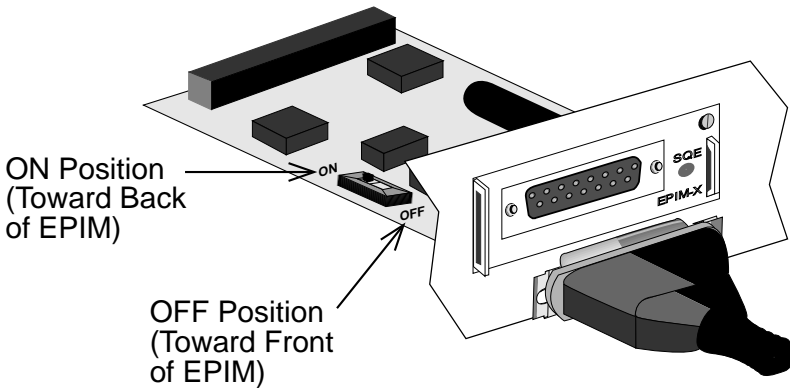

Figure 4-7. The EPIM-X

### 4.2 FINISHING THE INSTALLATION

The SEH is now ready for operation. Before placing the network into service, test the installation thoroughly, making sure that you can address all stations and that the SEH and all stations are indicating normal operation. Ensure that the networking software is configured properly to match the installed network. If you encounter errors or abnormal operation, proceed to Chapter 5, **Troubleshooting**.

## **CHAPTER 5**

### **TROUBLESHOOTING**

This chapter contains instructions for using LANVIEW LEDs to troubleshoot physical layer network problems.

#### **5.1 INSTALLATION CHECK-OUT**

After you connect the SEH to the network, verify that packets pass between all Ethernet devices connected to the SEH and any other devices connected to the network. If you encounter difficulty with any of the attached devices, check the link as follows:

1. Check that the **LNK LED**, if applicable, for the port is on. If the LED is not on:
  - a. Check that the 10BASE-T device at the other end of the twisted pair segment is powered up.
  - b. Verify that the connector on the twisted pair segment has the proper pinouts. Refer to Chapter 2 for the pin assignments for twisted pair connectors.

For EPIM-F1/EPIM-F2/EPIM-F3 check that the TX and RX fibers are properly connected.

- c. Check the cable for continuity. A variety of tools are available for this test, depending on the media you are using.
- d. Check that the twisted pair segments meet cable specifications for dB loss described in Chapter 2.

## TROUBLESHOOTING

---

2. If the remote station is ready and the **LNK** LED is on, but no data passes through the port, one of two conditions may exist:
  - Network management has disabled the port.
  - The port is segmented either because the collision detector was on for more than 110  $\mu$ sec. or the SEH detected more than 32 consecutive collisions on the attached segment. The affected port remains segmented until a good packet is transmitted/received without collisions.

If the **LNK** LED is still not on, contact Cabletron Systems Technical Support.

### 5.2 USING LANVIEW

The SEH incorporates the Cabletron Systems LANVIEW Status Monitoring and Diagnostics System. LANVIEW LEDs can help diagnose problems such as a power failure or a cable fault. The SEH includes the following LANVIEW LEDs:

- **PWR**, for power status
- **MGMT**, for management status
- **RCV** (Receive), **LNK** (Link), and **CLN** (Collision) for Ethernet status.

Figure 5-1 provides a quick reference chart of LED locations and definitions. This chapter also includes a detailed description of each LED.

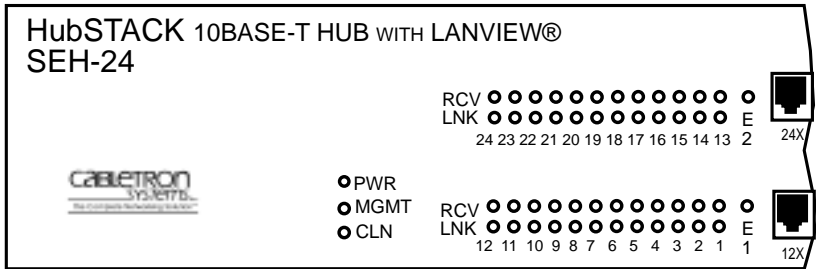

LED NAME	LED COLOR	DEFINITION
PWR (Power)	Off Green (Solid)	No Power Power
MGMT (Management)	Green (Flashing) Off	SEH Managed by an Intelligent Hub SEH Not Managed
CLN (Collision)	Red	Collision
RCV (Receive)	Yellow (Flashing) Off	SEH is Receiving Data No Activity
LNK (Link)	Green Off	Link Established No Link

Figure 5-1. LANVIEW LEDs

**PWR (Green)**

When this LED is on it indicates that the SEH is receiving power. If this LED is off, it indicates a loss of input power. Check the input power source (circuit breaker, fuse, etc.). If the proper source power is present, the problem could be with the SEH.

**MGMT (Green Flashing)**

This LED flashes when an intelligent hub manages the SEH. If this LED does not flash, an intelligent hub is not managing the SEH. If you connect an intelligent hub to the SEH and the LED does not flash, inspect the HubSTACK Interconnect cables for proper connections.

## **TROUBLESHOOTING**

---

### **CLN (Red)**

This LED indicates that a collision has occurred on one of the ports.

### **RCV (Yellow Flashing)**

When this LED flashes, it indicates that the SEH is receiving data packets from the associated port segment. Each SEH port has a corresponding RCV LED:

- Network Ports: RCV LEDs **1-24**
- EPIM-1: RCV LED **E1**
- EPIM-2: RCV LED **E2**

### **LNK (Green)**

When a LNK LED is on, it indicates an established link between the associated twisted pair segment and the 10BASE-T device at the other end of the segment. LNK LEDs will remain on as long as a link is maintained. Each SEH Network Port (ports **1-24**) has a corresponding LNK LED.

### **APPENDIX A**

#### **TWISTED PAIR WIRING TABLES**

This appendix contains twisted pair wiring tables which will assist you if you are using a Punch Down block (see Figure A-1) to wire your twisted pair segments. The following tables are included in this appendix:

- Table A-1 Twisted Pair Wiring from an SEH to a Punch Down Block
- Table A-2 Twisted Pair Wiring from a Punch Down Block to a 10BASE-T Device
- Table A-3 Twisted Pair Wiring Summary

## TWISTED PAIR WIRING TABLES

**Note:** Pins 25 and 50 on Champ connector are not used.

Table A-1. Twisted Pair Wiring  
from an SEH-32/34 to a Punch Down Block

<b>From SEH-32/34</b>	<b>Into and Out of 50-Pin Feeder Cable</b>	<b>Into Punch Down Block</b>
Port 12/24		
Pin	Pin	Pin
RX+ 48	48 Violet/Green RX+	A45 Violet/Green RX+
RX- 23	23 Green/Violet RX-	A46 Green/Violet RX-
TX+ 49	49 Violet/Brown TX+	A47 Violet/Brown TX+
TX- 24	24 Brown/Violet TX-	A48 Brown/Violet TX-
Port 11/23		
Pin	Pin	Pin
RX+ 46	46 Violet/Blue RX+	A41 Violet/Blue RX+
RX- 21	21 Blue/Violet RX-	A42 Blue/Violet RX-
TX+ 47	47 Violet/Orange TX+	A43 Violet/Orange TX+
TX- 22	22 Orange/Violet TX-	A44 Orange/Violet TX-
Port 10/22		
Pin	Pin	Pin
RX+ 44	44 Yellow/Brown RX+	A37 Yellow/Brown RX+
RX- 19	19 Brown/Yellow RX-	A38 Brown/Yellow RX-
TX+ 45	45 Yellow/Gray TX+	A39 Yellow/Gray TX+
TX- 20	20 Gray/Yellow TX-	A40 Gray/Yellow TX-
Port 9/21		
Pin	Pin	Pin
RX+ 42	42 Yellow/Orange RX+	A33 Yellow/Orange RX+
RX- 17	17 Orange/Yellow RX-	A34 Orange/Yellow RX-
TX+ 43	43 Yellow/Green TX+	A35 Yellow/Green TX+
TX- 18	18 Green/Yellow TX-	A36 Green/Yellow TX-



## TWISTED PAIR WIRING TABLES

Table A-1. Twisted Pair Wiring  
from an SEH-32/34 to a Punch Down Block (Continued)

<b>From SEH-32/34</b>	<b>Into and Out of 50-Pin Feeder Cable</b>	<b>Into Punch Down Block</b>
<b>Port 8/20</b>		
Pin	Pin	Pin
RX+ 40	40 Black/Gray RX+	A29 Black/Gray RX+
RX- 15	15 Gray/Black RX-	A30 Gray/Black RX-
TX+ 41	41 Yellow/Blue TX+	A31 Yellow/Blue TX+
TX- 16	16 Blue/Yellow TX-	A32 Blue/Yellow TX-
<b>Port 7/19</b>		
Pin	Pin	Pin
RX+ 38	38 Black/Green RX+	A25 Black/Green RX+
RX- 13	13 Green/Black RX-	A26 Green/Black RX-
TX+ 39	39 Black/Brown TX+	A27 Black/Brown TX+
TX- 14	14 Brown/Black TX-	A28 Brown/Black TX-
<b>Port 6/18</b>		
Pin	Pin	Pin
RX+ 36	36 Black/Blue RX+	A21 Black/Blue RX+
RX- 11	11 Blue/Black RX-	A22 Blue/Black RX-
TX+ 37	37 Black/Orange TX+	A23 Black/Orange TX+
TX- 12	12 Orange/Black TX-	A24 Orange/Black TX-
<b>Port 5/17</b>		
Pin	Pin	Pin
RX+ 34	34 Red/Brown RX+	A17 Red/Brown RX+
RX- 9	9 Brown/Red RX-	A18 Brown/Red RX-
TX+ 35	35 Red/Gray TX+	A19 Red/Gray TX+
TX- 10	10 Gray/Red TX-	A20 Gray/Red TX-

## TWISTED PAIR WIRING TABLES

Table A-1. Twisted Pair Wiring  
from an SEH-32/34 to a Punch Down Block (Continued)

<b>From SEH-32/34</b>	<b>Into and Out of 50-Pin Feeder Cable</b>	<b>Into Punch Down Block</b>
<b>Port 4/16</b>		
Pin	Pin	Pin
RX+ 32	32 Red/Orange RX+	A13 Red/Orange RX+
RX- 7	7 Orange/Red RX-	A14 Orange/Red RX-
TX+ 33	33 Red/Green TX+	A15 Red/Green TX+
TX- 8	8 Green/Red TX-	A16 Green/Red TX
<b>Port 3/15</b>		
Pin	Pin	Pin
RX+ 30	30 White/Gray RX+	A9 White/Gray RX+
RX- 5	5 Gray/White RX-	A10 Gray/White RX-
TX+ 31	31 Red/Blue TX+	A11 Red/Blue TX+
TX- 6	6 Blue/Red TX-	A12 Blue/Red TX-
<b>Port 2/14</b>		
Pin	Pin	Pin
RX+ 28	28 White/Green RX+	A5 White/Green RX+
RX- 3	3 Green/White RX-	A6 Green/White RX-
TX+ 29	29 White/Brown TX+	A7 White/Brown TX+
TX- 4	4 Brown/White TX-	A8 Brown/White TX-
<b>Port 1/13</b>		
Pin	Pin	Pin
RX+ 26	26 White/Blue RX+	A1 White/Blue RX+
RX- 1	1 Blue/White RX-	A2 Blue/White RX-
TX+ 27	27 White/Orange TX+	A3 White/Orange TX+
TX- 2	2 Orange/White TX-	A4 Orange/White TX-

## TWISTED PAIR WIRING TABLES

Table A-2. Twisted Pair Wiring  
from a Punch Down Block to a 10Base-T Device

From Punch Down Block	To RJ-45 Wallplate	Into Office Drop	Into 10BASE-T Device
Port 12/24	Pin	Pin	Pin
B45 Violet/Green RX+	1 TX+	1 TX+	1 TX+
B46 Green/Violet RX-	2 TX-	2 TX-	2 TX-
B47 Violet/Brown TX+	3 RX+	3 RX+	3 RX+
B48 Brown/Violet TX-	6 RX-	6 RX-	6 RX-
Port 11/23	Pin	Pin	Pin
B41 Violet/Blue RX+	1 TX+	1 TX+	1 TX+
B42 Blue/Violet RX-	2 TX-	2 TX-	2 TX-
B43 Violet/Orange TX+	3 RX+	3 RX+	3 RX+
B44 Orange/Violet TX-	6 RX-	6 RX-	6 RX-
Port 10/22	Pin	Pin	Pin
B37 Yellow/Brown RX+	1 TX+	1 TX+	1 TX+
B38 Brown/Yellow RX-	2 TX-	2 TX-	2 TX-
B39 Yellow/Gray TX+	3 RX+	3 RX+	3 RX+
B40 Gray/Yellow TX-	6 RX-	6 RX-	6 RX-
Port 9/21	Pin	Pin	Pin
B33 Yellow/Orange RX+	1 TX+	1 TX+	1 TX+
B34 Orange/Yellow RX-	2 TX-	2 TX-	2 TX-
B35 Yellow/Green TX+	3 RX+	3 RX+	3 RX+
B36 Green/Yellow TX-	6 RX-	6 RX-	6 RX-

## TWISTED PAIR WIRING TABLES

Table A-2. Twisted Pair Wiring  
from a Punch Down Block to a 10Base-T Device (Continued)

<b>From Punch Down Block</b>	<b>To RJ-45 Wallplate</b>	<b>Into Office Drop</b>	<b>Into 10BASE-T Device</b>
Port 8/20	Pin	Pin	Pin
B29 Black/Gray RX+	1 TX+	1 TX+	1 TX+
B30 Gray/Black RX-	2 TX-	2 TX-	2 TX-
B31 Yellow/Blue TX+	3 RX+	3 RX+	3 RX+
B32 Blue/Yellow TX-	6RX-	6 RX-	6 RX-
Port 7/19	Pin	Pin	Pin
B25 Black/Green RX+	1 TX+	1 TX+	1 TX+
B26 Green/Black RX-	2 TX-	2 TX-	2 TX-
B27 Black/Brown TX+	3 RX+	3 RX+	3 RX+
B28 Brown/Black TX-	6 RX-	6 RX-	6 RX-
Port 6/18	Pin	Pin	Pin
B21 Black/Blue RX+	1 TX+	1 TX+	1 TX+
B22 Blue/Black RX-	2 TX-	2 TX-	2 TX-
B23 Black/Orange TX+	3 RX+	3 RX+	3 RX+
B24 Orange/Black TX-	6 RX-	6 RX-	6 RX-
Port 5/17	Pin	Pin	Pin
B17 Red/Brown RX+	1 TX+	1 TX+	1 TX+
B18 Brown/Red RX-	2 TX-	2 TX-	2 TX-
B19 Red/Gray TX+	3 RX+	3 RX+	3 RX+
B20 Gray/Red TX-	6 RX-	6 RX-	6 RX-

## TWISTED PAIR WIRING TABLES

Table A-2. Twisted Pair Wiring  
from a Punch Down Block to a 10Base-T Device (Continued)

From Punch Down Block		To RJ-45 Wallplate	Into Office Drop	Into 10BASE-T Device
Port 4/16		Pin	Pin	Pin
B13	Red/Orange RX+	1 TX+	1 TX+	1 TX+
B14	Orange/Red RX-	2 TX-	2 TX-	2 TX-
B15	Red/Green TX+	3 RX+	3 RX+	2 TX-
B16	Green/Red TX-	6 RX-	6 RX-	6 RX-
Port 3/15		Pin	Pin	Pin
B9	White/Gray RX+	1 TX+	1 TX+	1 TX+
B10	Gray/White RX-	2 TX-	2 TX-	2 TX-
B11	Red/Blue TX+	3 RX+	3 RX+	3 RX+
B12	Blue/Red TX-	6 RX-	6 RX-	6 RX-
Port 2/14		Pin	Pin	Pin
B5	White/Green RX+	1 TX+	1 TX+	1 TX+
B6	Green/White RX-	2 TX-	2 TX-	2 TX-
B7	White/Brown TX+	3 RX+	3 RX+	3 RX+
B8	Brown/White TX-	6 RX-	6 RX-	6 RX-
Port 1/13		Pin	Pin	Pin
B1	White/Blue RX+	1 TX+	1 TX+	1 TX+
B2	Blue/White RX-	2 TX-	2 TX-	2 TX-
B3	White/Orange TX+	3 RX+	3 RX+	3 RX+
B4	Orange/White TX-	6 RX-	6 RX-	6 RX-

# TWISTED PAIR WIRING TABLES

Table A-3. Twisted Pair Wiring Summary

<b>SEH-32/34 Champ</b>	<b>Punch Down Block</b>	<b>Wall Plate (If Required)</b>	<b>10BASE-T Ethernet Device</b>
<b>Port 12</b>			
48 RX+ 23 RX-	A45 RX+ A46 RX-	$\left\{ \begin{array}{c} 4 \text{ Pair} \\ \text{Twisted} \\ \text{Distribution} \\ \text{Cable} \end{array} \right\}$	PIN 1 TX+ PIN 2 TX-
49 TX+ 24 TX-	A47 TX+ A48 TX-		$\left\{ \begin{array}{c} \text{Office} \\ \text{Drop} \end{array} \right\}$
			PIN 1 TX+ PIN 2 TX-  PIN 3 RX+ PIN 6 RX+
<b>Port 11</b>			
46 RX+ 21 RX-	A41 RX+ A42 RX-	$\left\{ \begin{array}{c} 4 \text{ Pair} \\ \text{Twisted} \\ \text{Distribution} \\ \text{Cable} \end{array} \right\}$	PIN 1 TX+ PIN 2 TX-
47 TX+ 22 TX-	A43 TX+ A44 TX-		$\left\{ \begin{array}{c} \text{Office} \\ \text{Drop} \end{array} \right\}$
			PIN 1 TX+ PIN 2 TX-  PIN 3 RX+ PIN 6 RX-
:	:	:	:
:	:	:	:
:	:	:	:
:	:	:	:
:	:	:	:
:	:	:	:
:	:	:	:
:	:	:	:
:	:	:	:
:	:	:	:
:	:	:	:
:	:	:	:
:	:	:	:
<b>Port 1</b>			
26 RX+ 1 RX-	A1 RX+ A2 RX-	$\left\{ \begin{array}{c} 4 \text{ Pair} \\ \text{Twisted} \\ \text{Distribution} \\ \text{Cable} \end{array} \right\}$	PIN 1 TX+ PIN 2 TX-
27 TX+ 2 TX-	A3 TX+ A4 TX-		$\left\{ \begin{array}{c} \text{Office} \\ \text{Drop} \end{array} \right\}$
			PIN 1 TX+ PIN 2 TX-  PIN 3 RX+ PIN 6 RX-

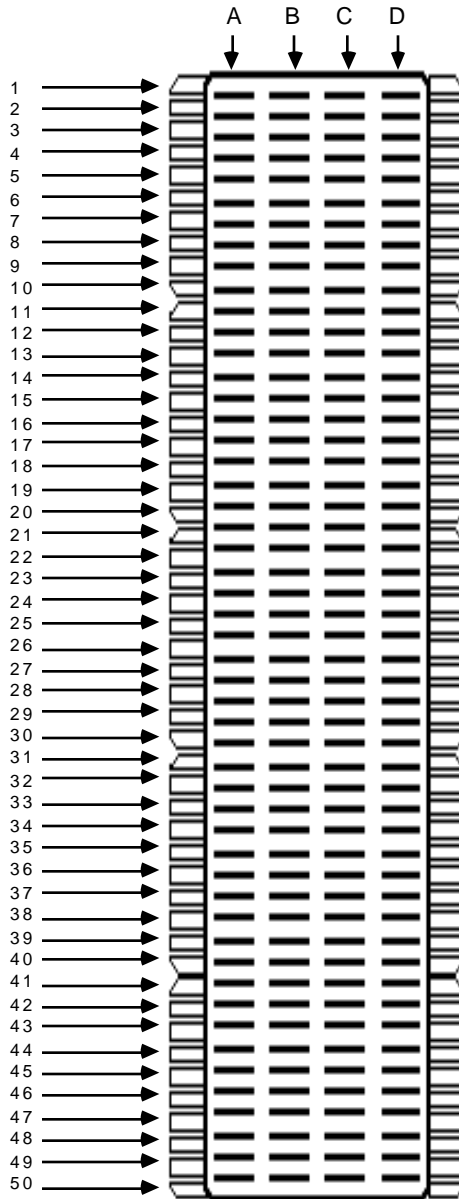

Figure A-1. Punch Down Block

## **POWER SUPPLY CORD**

The mains cord used with this equipment must be a 2 conductor plus ground type with minimum 0.75 mm square conductors and must incorporate a standard IEC appliance coupler on one end and a mains plug on the other end which is suitable for the use and application of the product and that is approved for use in the country of application.

### **GERMAN:**

Die Netzleitung, die mit diesem Geraet benuetzt wird, soll einen zwei Leiter mit Erdleiter haben, wobei die Leiter mindestens 0.75 mm sind, mit einer normalen IEC Geraetesteckdose an einem Ende und einem Geraetestecker am anderen Ende versehen sind, der fuer den Gebrauch und die Anwendung des Geraetes geeignet und der zum Benuetzen im Lande der Anwendung anerkannt ist.

### **SPANISH:**

El cable principal de la red eléctrica utilizado con este equipo debe tener 2 conductores y 1 toma de tierra con un mínimo de 0.75 mm<sup>2</sup> cada uno y necesita tener un aparato de acoplamiento standard IEC en un extremo y un enchufe para el cable principal de la red eléctrica en el otro extremo, lo cual sea adecuado para el uso y aplicación del producto y lo cual sea aprobado para uso en el país de aplicación.

### **FRENCH:**

Le cordon d'alimentation reliant cet appareil au secteur doit obligatoirement avoir deux fils conducteurs de 0.75 mm<sup>2</sup> minimum et un fil de terre. Il doit également être équipé du côté appareil d'une fiche agréée IEC et du côté secteur, d'une prise adaptée à l'usage du produit et aux normes du pays où l'appareil est utilisé.



## Free Manuals Download Website

<http://myh66.com>

<http://usermanuals.us>

<http://www.somanuals.com>

<http://www.4manuals.cc>

<http://www.manual-lib.com>

<http://www.404manual.com>

<http://www.luxmanual.com>

<http://aubethermostatmanual.com>

Golf course search by state

<http://golfingnear.com>

Email search by domain

<http://emailbydomain.com>

Auto manuals search

<http://auto.somanuals.com>

TV manuals search

<http://tv.somanuals.com>