

DIGITAL VIDEO CAMCORDER  
**Instruction Manual**

CAMESCOPE ET LECTEUR VIDEO NUMERIQUES  
**Mode d'emploi**

VIDEOCAMARA Y GRABADORA DIGITAL  
**Manual de Instrucciones**

ENGLISH

**E**

FRANÇAIS

**F**

ESPAÑOL

**Es**

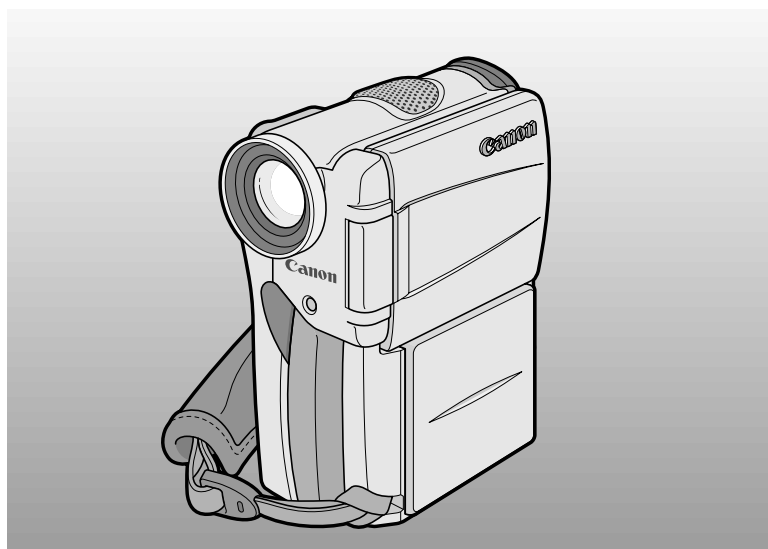

**Canon**

Mini DV Digital Video Cassette

**ELURA 2/ELURA 2MC**

This instruction book explains the use of the ELURA2 and ELURA2 MC camcorders. The only difference between these models is that the ELURA2 MC includes a MultiMediaCard Memory Card function. Please note that illustrations in this instruction book refer mainly to the ELURA2 model.

Ce mode d'emploi explique l'utilisation des caméscopes ELURA2 et ELURA2 MC. L'unique différence entre ces deux modèles réside dans le fait que le modèle ELURA2 MC possède une carte de mémoire MultiMedia. Veuillez noter que des illustrations de ce mode d'emploi renvoient essentiellement au modèle ELURA2.

Este manual de instrucciones explica el uso de las videocámaras ELURA2 y ELURA2 MC. La única diferencia entre estos dos modelos radica en que la ELURA2 MC incluye una función de tarjeta de memoria MultiMediaCard. Por favor tenga en cuenta que las instrucciones de este manual de instrucciones corresponden principalmente al modelo ELURA2.

**NTSC**

## Important Usage Instructions

E

**WARNING:**

**TO REDUCE THE RISK OF FIRE OR ELECTRIC SHOCK, DO NOT EXPOSE THIS PRODUCT TO RAIN OR MOISTURE.**

**WARNING:**

**TO REDUCE THE RISK OF ELECTRIC SHOCK AND TO REDUCE ANNOYING INTERFERENCE, USE THE RECOMMENDED ACCESSORIES ONLY.**

**COPYRIGHT WARNING:**

**Unauthorized recording of copyrighted materials may infringe on the rights of copyright owners and be contrary to copyright laws.**

Digital Video Camcorder, ELURA2/ELURA2 MC and Compact Power Adapter, CA-400

This device complies with Part 15 of the FCC Rules. Operation is subject to the following two conditions: (1) This device may not cause harmful interference, and (2) this device must accept any interference received, including interference that may cause undesired operation.

Note: This equipment has been tested and found to comply with the limits for class B digital device, pursuant to Part 15 of the FCC Rules. These limits are designed to provide reasonable protection against harmful interference in a residential installation. This equipment generates, uses and can radiate radio frequency energy and, if not installed and use in accordance with the instructions, may cause harmful interference to radio communications. However, there is no guarantee that interference will not occur in a particular installation. If this equipment does cause harmful interference to radio or television reception, which can be determined by turning the equipment off and on, the user is encouraged to try to correct the interference by one or more of the following measures:

- Reorient or relocate the receiving antenna.
- Increase the separation between the equipment and receiver.
- Connect the equipment into an outlet on a circuit different from that to which the receiver is connected.
- Consult the dealer or an experienced radio/TV technician for help.

Use of shielded cable is required to comply with class B limits in Subpart B of Part 15 of FCC Rules. Do not make any changes or modifications to the equipment unless otherwise specified in the manual. If such changes or modifications should be made, you could be required to stop operation of the equipment.

Canon U.S.A. Inc.  
One Canon Plaza, Lake Success, NY 11042, U.S.A.  
Tel No. (516)328-5600

Introduction

**CAUTION:**

**TO PREVENT ELECTRIC SHOCK, MATCH WIDE BLADE OF PLUG TO WIDE SLOT, FULLY INSERT.**

**Important Warning**

The lightning flash with arrowhead symbol, within an equilateral triangle, is intended to alert the user to the presence of uninsulated "dangerous voltage" within the product's enclosure, that may be of sufficient magnitude to constitute a risk of electric shock to persons.

**CAUTION:**

**TO REDUCE THE RISK OF ELECTRIC SHOCK, DO NOT REMOVE COVER (OR BACK). NO USER-SERVICEABLE PARTS INSIDE. REFER SERVICING TO QUALIFIED SERVICE PERSONNEL.**



The exclamation point, within an equilateral triangle, is intended to alert the user to the presence of important operating and maintenance (servicing) instructions in the literature accompanying the product.

2

# IMPORTANT SAFETY INSTRUCTIONS

In these safety instructions the word “product” refers to the Canon Digital Video Camcorder ELURA2/ELURA2 MC and all its accessories.

1. **Read Instructions** — All the safety and operating instructions should be read before the product is operated.
2. **Retain Instructions** — The safety and operating instructions should be retained for future reference.
3. **Heed Warnings** — All warnings on the product and in the operating instructions should be adhered to.
4. **Follow Instructions** — All operating and maintenance instructions should be followed.
5. **Cleaning** — Unplug this product from the wall outlet before cleaning. Do not use liquid or aerosol cleaners. The product should be cleaned only as recommended in this manual.
6. **Accessories** — Do not use accessories not recommended in this manual as they may be hazardous.
7. **Avoid magnetic or electric fields** — Do not use the camera close to TV transmitters, portable communication devices or other sources of electric or magnetic radiation. They may cause picture interference, or permanently damage the camera.
8. **Water and Moisture** — Hazard of electric shock — Do not use this product near water or in rainy/moist situations.
9. **Placing or Moving** — Do not place on an unstable cart, stand, tripod, bracket or table. The product may fall, causing serious injury to a child or adult, and serious damage to the product. A product and cart combination should be moved with care. Quick stops, excessive force, and uneven surfaces may cause the product and cart combination to overturn.
 
10. **Power Sources** — The CA-400 Compact Power Adapter should be operated only from the type of power source indicated on the marking label. If you are not sure of the type of power supply to your home, consult your product dealer or local power company. Regarding other power sources such as battery power, refer to instructions in this manual.
11. **Polarization** — The CA-400 Compact Power Adapter is equipped with a polarized 2-prong plug (a plug having one blade wider than the other). The 2-prong polarized plug will fit into the power outlet only one way. This is a safety feature. If you are unable to insert the plug fully into the outlet, try reversing the plug. If the plug still fails to fit, contact your electrician to replace your obsolete outlet. Do not defeat the safety purpose of the polarized plug.
12. **Power Cord Protection** — Power cords should be routed so that they are not likely to be walked on or pinched by items placed upon or against them. Pay particular attention to plugs and the point from which the cords exit the product.
13. **Outdoor Antenna Grounding** — If an outside antenna is connected to the product, be sure the antenna is grounded so as to provide some protection against voltage surges and built-up static charges. Section 810 of the National Electrical Code, ANSI / NFPA No. 70—1984, provides information with respect to proper grounding of the mast and supporting structure, grounding of the lead-in wire to an antenna discharge unit, size of grounding conductors, location of antenna discharge unit, connection to grounding electrodes, and requirements for the grounding electrode. See figure 1.

E

Introduction

E

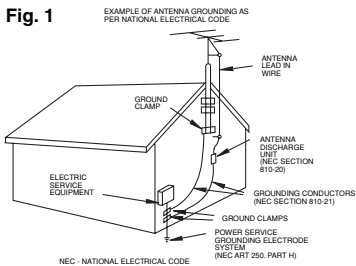

14. **Lightning** — For added protection of this product during a lightning storm, or when it is left unattended and unused for long periods of time, disconnect it from the wall outlet and disconnect the antenna. This will prevent damage to the product due to lightning and power-line surges.
15. **Power Lines** — An outside antenna system should not be located in the vicinity of overhead power lines or other electric light or power circuits, or where it can fall into such power lines or circuits. When installing an outside antenna system, extreme care should be taken to keep from touching such power lines or circuits as contact with them might be fatal.
16. **Overloading** — Do not overload wall outlets and extension cords as this can result in a risk of fire or electric shock.
17. **Objects and Liquid Entry** — Never push objects of any kind into this product through openings as they may touch dangerous voltage points or short out parts that could result in a fire or electric shock. Be careful not to spill liquid of any kind onto the product.
18. **Servicing** — Do not attempt to service this product yourself as opening or removing covers may expose you to dangerous voltage or other hazards. Refer all servicing to qualified service personnel.
19. **Damage Requiring Service** — Disconnect this product from the wall outlet and all power sources including battery, and refer servicing to qualified service personnel under the following conditions:
- When the power-supply cord or plug is damaged.
  - If any liquid has been spilled onto, or objects have fallen into, the product.
  - If the product has been exposed to rain or water.
  - If the product does not operate normally even if you follow the operating instructions. Adjust only those controls that are covered by the operation instructions. Improper adjustment of other controls may result in damage and will often require extensive work by a qualified technician to restore the product to its normal operation.
  - If the product has been dropped or the cabinet has been damaged.
  - When the product exhibits a distinct change in performance. This indicates a need for service.
20. **Replacement Parts** — When replacement parts are required, be sure the service technician has used replacement parts that are specified by Canon or that have the same characteristics as the original part. Unauthorized substitutions may result in fire, electric shock or other hazards.
21. **Safety Check** — Upon completion of any service or repairs to this product, ask the service technician to perform safety checks to determine that the product is in safe operating order.

## Contents

### Introduction

Important Usage Instructions .....	2
IMPORTANT SAFETY INSTRUCTIONS .....	3
Thank you for Choosing a Canon .....	6
Introducing the ELURA2/ELURA2 MC ..	7

### Mastering the Basics

Finding Your Way Around the ELURA2/ELURA2 MC .....	8
<b>~ Preparations ... ~</b>	
Powering Your Camcorder .....	11
Loading a Cassette .....	14
<b>~ Basic Recording ... ~</b>	
Basic Recording .....	16
Zooming .....	20
Using the LCD Screen .....	21
<b>~ Basic Playback ... ~</b>	
Playing Back a Cassette .....	24
Connections for Playback on a TV Screen.....	28
Tips for Making Better Videos .....	31

### Using the Full Range of Features

<b>~ General ... ~</b>	
Turning the Image Stabilizer Off .....	33
Using the Menus .....	34
Using the Wireless Controller/Tally Lamp .....	42
<b>~ For Recording ...~</b>	
Setting the Date and Time .....	45
Recording in Progressive Scan Mode (Digital Motor Drive).....	48
Taking Still Pictures to a Cassette.....	49
Transferring Still Pictures to a PC with the FR-100 (optional).....	51
Searching and Reviewing While Recording .....	52
Using the Various Recording Programs.....	53
Using Digital Effects .....	57
Using the Multi-Image Screen .....	63
Audio Recording .....	65
Setting the Self-Timer .....	67
<b>~ When Making Manual Adjustments ...~</b>	
Adjusting Exposure Manually.....	69
Adjusting Focus Manually .....	72
Setting the White Balance .....	73

### ~ For Playback ...~

Displaying Date, Time and Camera Data (Data Code) .....	75
Searching the Tape (Photo Search/Date Search) .....	78
Returning to a Pre-Marked Position .....	79

### Editing

Editing to a VCR.....	80
Dubbing to/from a Cassette with Digital Video Equipment .....	81
Recording from a VCR, TV or Analog Camcorder (Analog Line-in) .....	83
Recording Over Existing Scenes (A/V Insert Editing) .....	85
Audio Dubbing .....	88
Setting the Audio Mix .....	91

### Using the MultiMediaCard (ELURA2 MC only)

MultiMediaCard Introduction .....	93
Recording Still Images to a MultiMediaCard .....	97
Recording an Image from a Cassette as a Still Image .....	99
Recording from Another DV Device as a Still Image .....	100
Viewing Still Images .....	101
Preventing Accidental Erasure (Protect) .....	103
Erasing Still Images .....	104
Combining Images and Recording Them to a Cassette (Card Mix) .....	106
Copying Still Images from a Cassette....	109
Copying MMC Still Images to a Cassette.....	110
Marking a Still Image for Printing (Print Mark) .....	111
Formatting a MultiMediaCard.....	112
Other Information and Precautions .....	113

### Additional Information

Preparing the Camera .....	116
Notes on Using the Batteries.....	117
Maintenance .....	120
Troubleshooting.....	124
The ELURA2/ELURA2 MC System Diagram .....	128
Optional Accessories .....	129
Screen Displays .....	132
Specifications .....	139
Index .....	140
Menu at a Glance .....	143

E

Introduction

5

## Thank you for Choosing a Canon

E

First, we'd like to thank you for purchasing this Canon camcorder. Its advanced technology makes it very easy to use — you will soon be making high-quality videos which will give you pleasure for years to come.

To get the most out of your new camcorder, we recommend that you read this manual thoroughly — there are many sophisticated features which will add to your recording enjoyment.





### Getting started

To get started we suggest that you master the basic operations of the camcorder first, before moving on to use its full range of features.





For quick reference (in addition to the contents and index) please refer to:

- Finding Your Way Around the ELURA2/ELURA2 MC ( 8 )
- Screen displays ( 132 )
- Troubleshooting — in case you run into any problems ( 124 )
- Menu at Glance ( 143 )

Symbols used in this instruction manual:

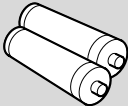
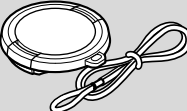
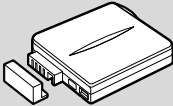
-  : Reference page numbers
-  : Functions that can be operated from the body of the camera
-  : Functions that can be operated from the wireless controller
-  : Supplementary notes for camcorder operation
-  : Operation confirmation beeps ( 19 )
- Capital letters are used to refer to settings displayed in the menus and buttons labeled on the camcorder itself, e.g. Press the MENU button.

Your camcorder is supplied with the following accessories:

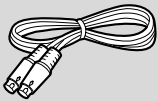
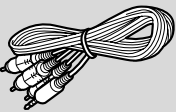
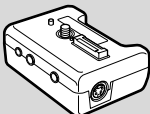
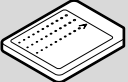
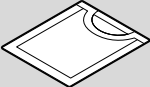
Wireless Controller ELURA2: WL-D76 ELURA2 MC: WL-D75 	Two AA batteries 
Lens cap and lens cap cord 	BP-406 Battery Pack 
CA-400 Compact Power Adapter (including AC power cable) 	DC-400 DC Coupler 
Lithium button battery 	S-150 S-video Cable 
STV-250N Stereo Video Cable 	DU-300 Docking Unit 
MMC-8M MultiMediaCard (with prerecorded sample images) (ELURA2 MC only) 	Soft case for MultiMediaCard (ELURA2 MC only) 

The serial number of this product may be found on the bottom of the camera. No others have the same serial number as yours. You should record the number and other vital information here and retain this book as a permanent record of your purchase to aid identification in case of theft.

Date of Purchase  
Dealer Purchased From  
Dealer Address  
Dealer Phone No.  
Model Name ELURA2/ELURA2 MC  
Serial No.

6

## Introducing the ELURA2/ ELURA2 MC

### IEEE 1394 DV Terminal



canon connects  
plug and edit

ELURA2/ELURA2 MC conforms to the digital video <sup>Mini</sup>DV standard and is equipped with the IEEE 1394 DV terminal to give you outstanding picture and sound quality.

### MultiMediaCard (ELURA2 MC only)

Record, manage and store still images on the MultiMediaCard. Combine still images recorded on the card with your original movies or still photographs. Also great for easy transfer to a PC.

### Progressive Scan CCD

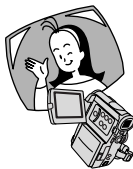

Shoot both superb quality video and beautifully clear still pictures (Digital Motor Drive). Choose your favorite scenes from videos (taken using progressive scan) and display them as blur-free still pictures too!

### 2.5" LCD Screen

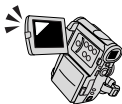

A 2.5" LCD screen makes it easy for you to shoot colorful, well composed video. It is also great for playback.

### Image Stabilizer



Stabilizes your recordings even in long telephoto shots.

### 10× Lens and 40× Digital Zoom



From wide-angle to 10× telephoto—with unparalleled optical quality. The digital zoom magnifies this up to 40× for even more dramatic results.

### Still Photos



The ELURA2/ELURA2 MC has the technology to capture crisp, clear, digital still pictures.

### Digital Effects



Advanced digital technology allows you to add special effects during recording or playback. Display 4, 9 or 16 still images at once with the multi-image screen.

### Audio Dubbing/A/V Insert Editing



Add new sound to original sound, or replace original sound and images on a prerecorded tape.

### Analog Line-in Recording

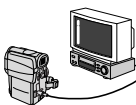

Connect to a VCR or analog camcorder and record onto a DV tape in the ELURA2/ELURA2 MC.

### PCM Digital Sound

E

Introduction

# Finding Your Way Around the ELURA2/ELURA2 MC

E

Mastering  
the Basics

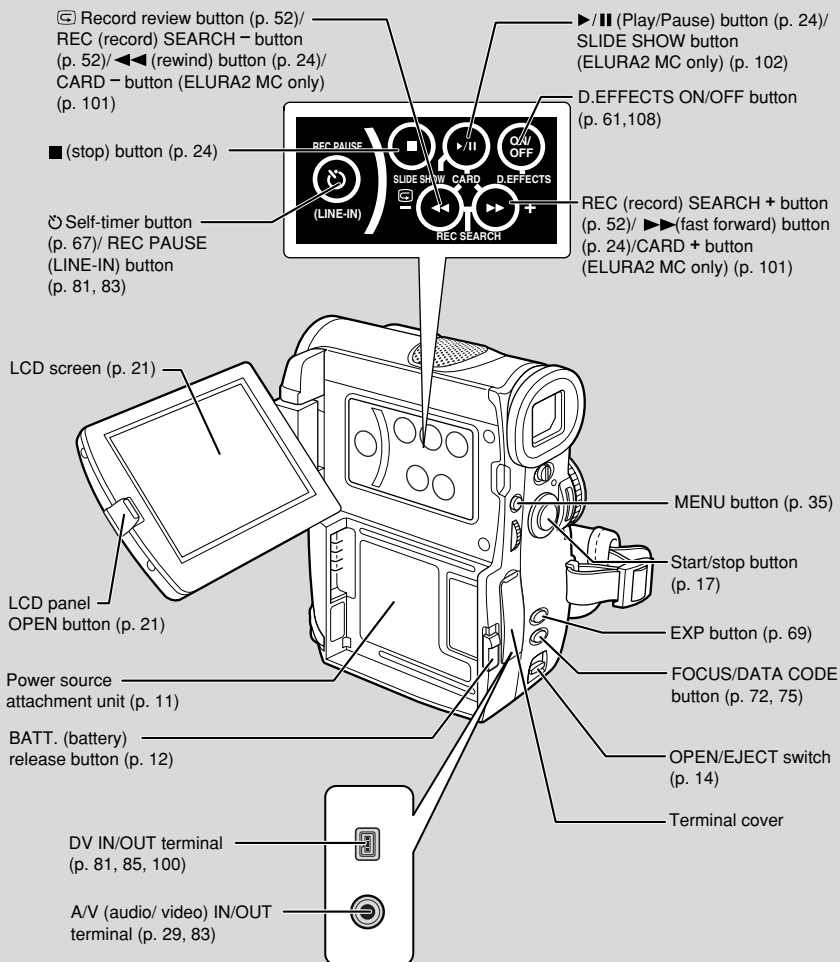



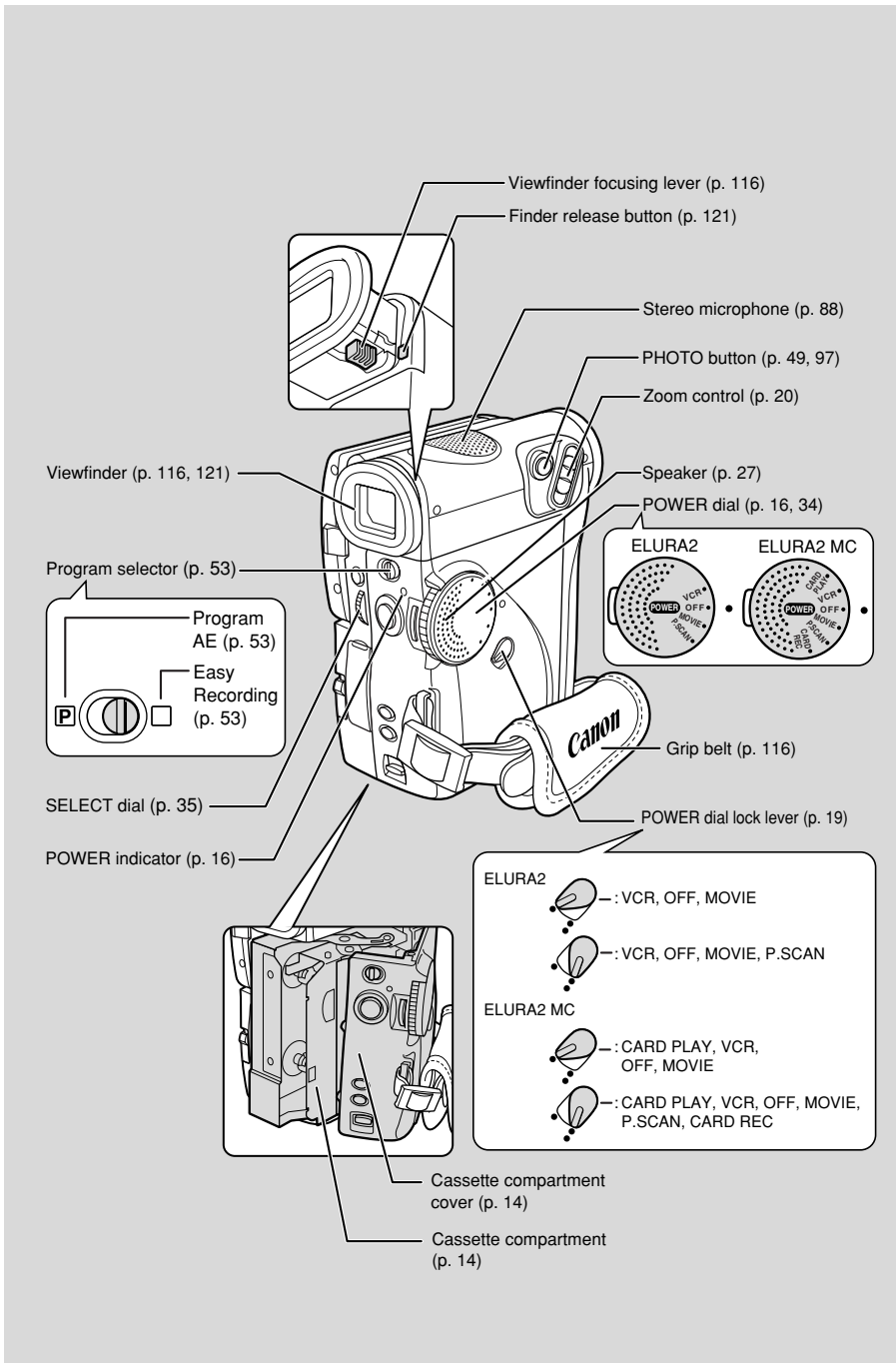

**E**

**Mastering  
the Basics**

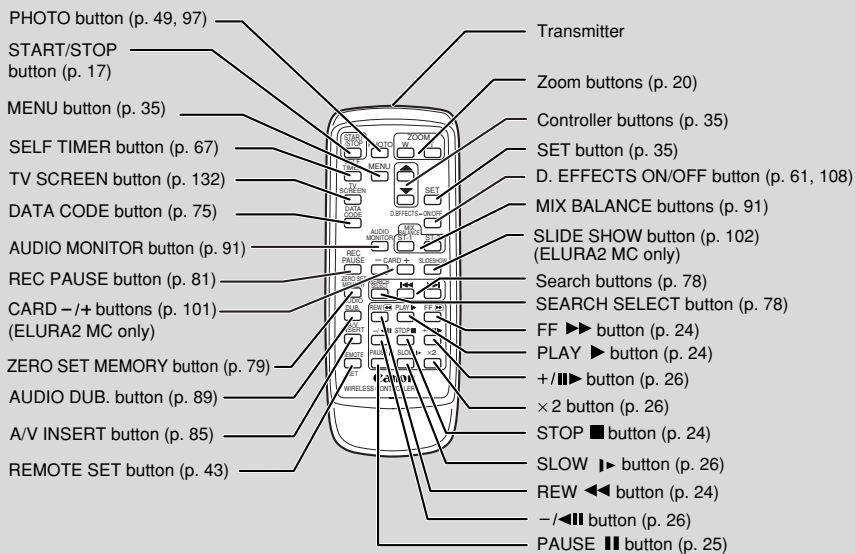
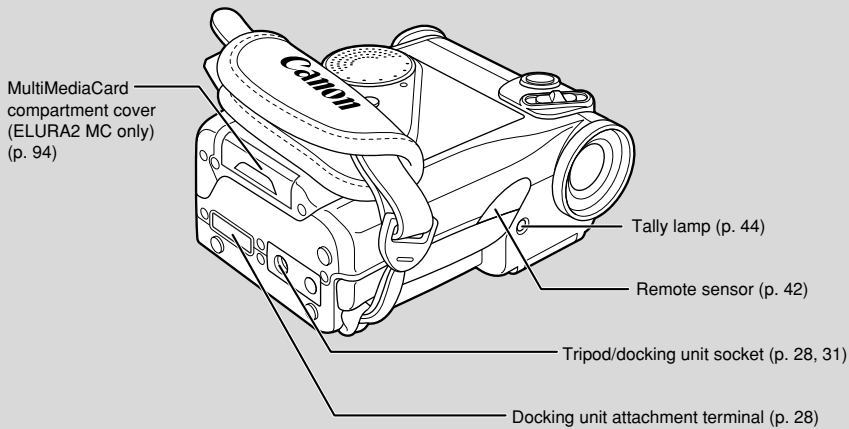

## Powering Your Camcorder

Before operating your camera, you will need to use the power adapter to:

**Provide power from an AC outlet**

or

**Charge a battery pack**



- The power adapter converts current from a household power socket (100–240 V AC, 50/60 Hz) to the DC current used by your camera.
- If the adapter is used next to a TV, it may cause bars to appear on the TV — move the adapter away from the TV or the antenna cable.

### Connecting the camera to an AC outlet

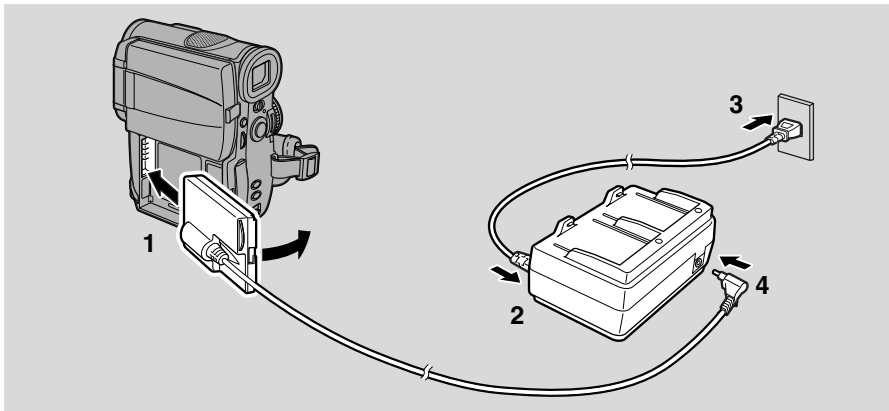

Use the power adapter to provide your camera with instant power from an AC outlet. Always turn the camera off before connecting/removing the power source.

- 1. Insert the DC coupler's terminals into the camera and press the other end until it clicks into place.**
- 2. Connect the power cable to the adapter.**
- 3. Plug the power cable into an AC outlet.**
- 4. Connect the DC coupler to the adapter.**
- 5. Remove the DC coupler from the camera after use, then disconnect it from the adapter. Then unplug the power cable from the AC outlet and disconnect it from the adapter.**
  - Press the BATT. release button and remove the coupler.

E

Mastering  
the Basics

## E

## Charging and attaching the battery packs

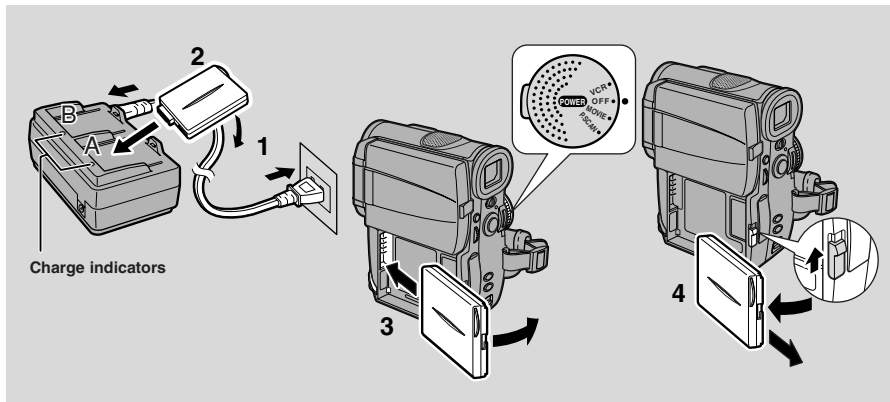

Your battery pack was partially charged before it left the factory. It should have enough power for you to check that your camera is working properly. However, you must charge the battery pack fully if you want it to power the camera for more than a few minutes.

The power adapter supplied with your camcorder can hold two battery packs and is capable of charging them one after another. Additional battery packs are available as an optional accessory ( 129).

Always turn the camera off before connecting/removing the battery.

### 1. Connect the power cable to the adapter and plug the power cable into an AC outlet.

- One of the two charge indicators flashes red to show that charging is in progress. Single flashes mean that the battery pack is less than 50% charged. Double flashes mean that it is between 50% and 75% charged. Triple flashes mean that it is more than 75% charged.
- The indicator glows steadily when the battery pack is fully charged.
- If the indicator blinks twice a second, the battery pack may be defective.
- If you attached two battery packs, the second battery pack now begins to charge: its indicator flashes red to show that charging is in progress.

### 2. Attach one or two battery packs to the power adapter.

- Remove the battery pack's terminal cover.
- Make sure the DC coupler is not connected.
- Insert the battery's terminals into the adapter and press the other end until it clicks into place.

### 3. Take the battery pack off the adapter and attach it to the camera.

### 4. Remove the battery pack after use.

- Press the BATT. release button and remove the battery.
- Be careful that the battery does not fall when you release it.



- The adapter can charge a single battery pack from either side, A or B. If you attach two battery packs, charging begins from the battery you first attach to the adapter, or, if the batteries are already attached to the adapter when you plug it into an AC outlet, from the side labeled “A”.
- When powering your camcorder from an AC outlet, you do not need to remove battery packs attached to the adapter, but charging will not take place until you remove the DC coupler from the adapter.
- Do not connect the power adapter to an unspecified product.
- You can find detailed notes for using the batteries in the “Notes on Using the Batteries” (📖 117). These notes include charging and recording times and how to install the backup battery.

E

### CA-400 Compact Power Adapter

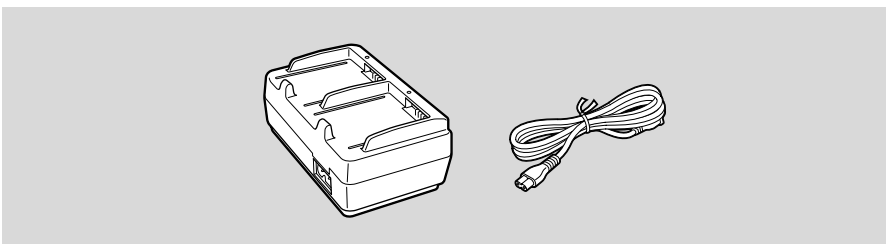
 Mastering  
the Basics

#### Specifications

<b>Power supply</b>	100–240 V AC, 50/60 Hz
<b>Power consumption</b>	40 W
<b>Rated output</b>	Adapter mode : 7.2 V, 2.0 A DC Charger mode : 8.4 V, 1.0/2.5 A DC
<b>Operating temperature range</b>	32°F–104°F (0°C–40°C)
<b>Dimensions</b>	3 × 4 3/4 × 2 1/8 in (75 × 120 × 53 mm)
<b>Weight</b>	8 7/8 oz (250 g) (without power cable)

Weight and dimensions are approximate.

Errors and omissions excepted.

Subject to change without notice.

When replacement of power supply is required, please return it to the responsible nearest Canon Service Center and please replace it with the same type number CA-400 or equivalent.

The Adapter can be used with a power supply between 100 and 240 V AC. For areas where 120 V AC power is not used, you will need a special plug adapter. Contact your nearest Canon Service Center for further information.

## Loading a Cassette

E

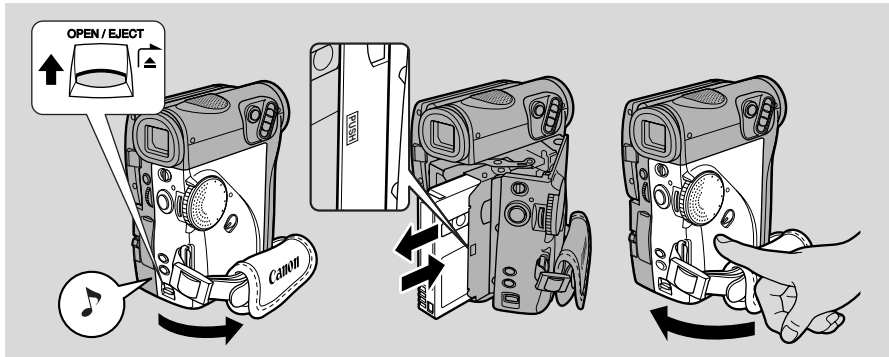

Only use videocassettes marked with the <sup>Mini</sup> DV logo.\*

### Loading and unloading

1. Make sure that you have attached a power source.
2. Slide the **OPEN / EJECT** switch upwards to release the cassette compartment cover.
  - Pull the cover fully open (while holding the button upwards) and wait a couple of seconds for the cassette compartment to open automatically.
  - The confirmation beep sounds when the cassette cover fully opens.
3. Load or unload the cassette.
  - Insert the cassette gently with the window facing out, and the REC/SAVE tab on the lower outer corner.
  - Remove the cassette by pulling it straight out.
4. Press the **(PUSH)** mark on the compartment until it clicks, and wait for it to close.
5. Click the cover back into place.

\* <sup>Mini</sup> DV is a trade mark.



- After loading a cassette, use record search ( 52) to find the point where you want to start recording.
- Do not interfere with the cassette compartment while it is opening or closing automatically, or attempt to close the cover.
- Be careful not to get your fingers caught in the cassette compartment cover.
- Do not leave the cassette in the camera after use — return it to its case and store it in a cool, clean, dry place.
- When you turn the camera's power on,  flashes in the display until you load a cassette.
- With some types of tapes, the remaining tape display may not give an accurate reading ( 133).

## Protecting tapes from accidental erasure

E

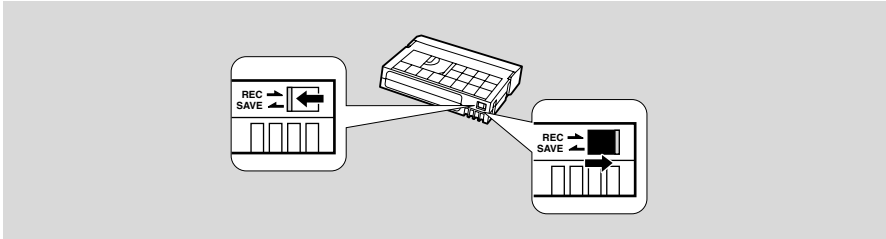

To protect your recording from accidental erasure, slide the tab on the cassette so that it exposes the hole. (This switch position is usually labeled SAVE or ERASE OFF.)

If you load this cassette and put the camera in record pause mode ( 16), “THE TAPE IS SET FOR ERASURE PREVENTION” is displayed for approx. 4 seconds and then the mark flashes in the display. The camera also shows the above phrase if you accidentally press the REC PAUSE button on the camera or the wireless controller with the camera switched to VCR mode.

If you want to record on the cassette again, slide the tab back so the hole is closed.

## Handling cassettes

- To protect the tape heads, transfer cassettes directly from the tape case to the camcorder — do not open the tape protect cover or touch the tape itself.
- Do not use cassettes where the tape has been damaged or spliced — they may damage the camcorder.
- Do not insert anything into the small holes on the cassette or cover them with cellophane tape.
- Handle cassettes with care — dropping them or exposing them to external shocks may cause internal damage.
- Store cassettes in the provided case, first rewinding them to the start of the tape and then storing them upright.
- A cassette with metal plated terminals may become dirty with use, affecting information transfer. Therefore, after using a tape about 10 times, be sure to clean the terminals with a cotton swab.

## Cassette memory

You are unable to use the cassette memory function with this camcorder.

Mastering  
the Basics

## Basic Recording



E

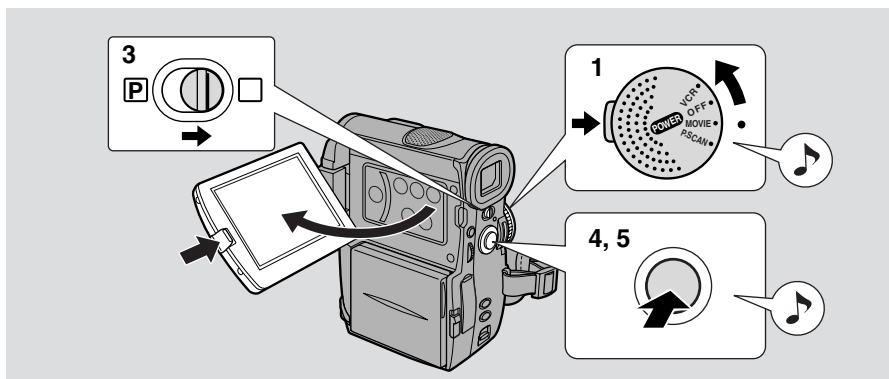

### Before you start recording

Have you completed the following steps?

- Attached a power source ( 11).
- Removed the lens cap ( 116).
- Chosen the display: viewfinder ( 116) or LCD screen ( 21)
- Extended the viewfinder ( 116) /adjusted the LCD screen ( 21)



- When you're using the viewfinder, fully close the LCD or rotate the LCD so that it faces the same direction as the lens ( 23).

You may also want to install the backup battery ( 119) in order to set the date and time display ( 45).

### To record

1. **Press the button next to the POWER dial and hold, turn the POWER dial to MOVIE.**
  - The camera automatically sets to record pause mode. PAUSE appears in the display.
  - The camera power indicator lights up red.
  - The confirmation beep sounds.
  - The camera will turn itself off if you leave it in record pause mode for more than about 5 minutes. To return to record pause mode, turn the POWER dial to OFF and then back to MOVIE.
  - For Progressive Scan recording, see p. 48. ELURA2 MC only: For still image recording to a MultiMediaCard, see p. 93.
2. **Load a cassette ( 14).**



**3. Slide the program selector to .**

- This selects the camera's Easy Recording program. It allows you to simply point and shoot without making any manual adjustments (  55).

**4. Press and release the start/stop button once to begin recording.**

- For still image recording to a cassette, see p. 49.

**5. Press and release the start/stop button again to pause recording.**

- The camera returns to record pause mode and PAUSE reappears in the display.
- You can stop and restart recording as often as you like by pressing the start/stop button.



- After loading a cassette, start recording when the tape counter has stopped.

**When you have finished recording**

- Replace the lens cap.
- Return the viewfinder to its retracted position.
- Return the LCD screen flush to the camera body.
- Unload the cassette.
- Turn the POWER dial to OFF.
- Disconnect the power source.



- To check that the camera is recording correctly, make a test recording first.
- Before making important recordings, clean the video heads using a Canon DVM-CL Digital Video Head Cleaning Cassette or a commercially available digital video head cleaning cassette.
- To close the LCD panel, rotate it vertically until the screen faces you, then push it in flat against the side of the camera until it clicks securely.
- You cannot monitor the sound from the speaker when recording.
- For tips on how to make better videos, see p. 31.
- For extra recording time, set REC MODE to LP (  18).

**E****Mastering  
the Basics**

## E

## Changing the recording mode (SP/LP)



You can record and play back a tape in SP (standard play) and LP (long play) modes. LP extends tape usage by 1.5 times.

You can't add sound (audio dubbing) or images (A/V insert) to a tape that has been recorded in LP mode. If you plan to use either of these functions later, record in SP mode.



### MENU

( 34)

►VCR SET UP

►REC MODE...SP

**To change to LP mode, open the menu and select VCR SET UP. Then select REC MODE, set it to LP and close the menu.**



- When recording and playing back tapes in LP mode, the nature of the tape and usage conditions may affect recording, mosaic-like noise may appear in the image and the sound may be distorted during playback. For important recordings, therefore, set the camera to SP mode.
- If you record in both modes on the same tape, the picture may become distorted during playback and the time code may not be written correctly.
- A tape recorded in LP mode on other digital equipment may produce mosaic-like noise and the sound may become distorted when played back on this camcorder, and vice versa.

## 16:9 (Widescreen TV recording)



Produces images in the 16:9 format for playback on widescreen TVs.

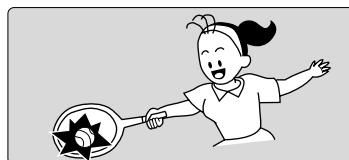

### MENU

( 34)

►CAM. SET UP

►16:9.....OFF

**To switch 16:9 to ON, open the menu and select CAM.SET UP. Then select 16:9, set it to ON and close the menu.**



- "16:9" is shown in the display when you switch the 16:9 mode on.
- You cannot use the 16:9 mode with the Easy Recording program.
- You cannot use the 16:9 mode when the multi-image screen is set. The 16:9 display becomes set to "---".
- If you play back a recording made for 16:9 on a normal TV screen, the image will appear to be vertically "squashed" (compressed).
- If you connect the camera to a TV with an S1 terminal or the Video ID-1 system, recordings made in the 16:9 mode for wide screen TVs will automatically play back in wide screen mode on the TV screen.

## Confirmation/Warning beeps



E

The camera's short operation confirmation beeps are indicated by  in the illustrations. Beeps sound upon certain camera operations such as when you turn the camera on, during the self-timer countdown, right before the camera's automatic shut-off, and also upon any unusual condition of the camera. Beeps are not recorded on the tape.







### MENU





(  34)



To turn the beep off, open the menu and select **SYSTEM**. Then select **BEEP**, set it to **OFF** and close the menu.

## About the POWER dial lock lever

The POWER dial lock lever has been preset to the  position. Switch it to the  position when you want to use the P. SCAN (  48) and CARD REC (ELURA2 MC only,  97) modes. It is recommended that you return the lock lever to the  position when you finish recording.

- ELURA2      : VCR, OFF, MOVIE  
                : VCR, OFF, MOVIE, P.SCAN
- ELURA2 MC      : CARD PLAY, VCR, OFF, MOVIE  
                    : CARD PLAY, VCR, OFF, MOVIE, P.SCAN, CARD REC

## Zooming



E

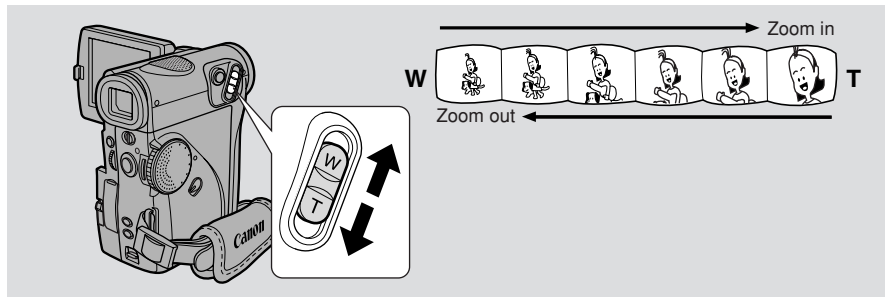

### 10× optical zoom

The camera's 10× zoom lens allows you to choose the best picture angle for each scene:

- Move the zoom control towards W to zoom out to wide-angle.
- Move it towards T to zoom in to telephoto.

You can also control the speed of zooming:

- Move the control slightly to zoom slowly.
- Move it farther to zoom more quickly. (The farther you move the zoom control, the faster the zoom speed.)

The T and W buttons on the wireless controller adjust the picture angle, but not the zoom speed.

### 40× digital zoom

Magnifies the camera's zoom range by up to 4×.

The zoom control continues to work as usual. You can freely zoom in and out between 1× and 40× magnification — the camera automatically switches between optical zooming (up to 10×) and digital zooming (10× to 40×). A zoom bar shows up in the display. The digital zoom area is in blue.



#### MENU

( 34 )

▶ CAM. SET UP

▶▶ D. ZOOM . . . . . ON

**To turn the digital zoom off, open the menu and select CAM.SET UP. Then select D.ZOOM, set it to OFF and close the menu.**



- When zooming, as a rule, keep at least 3 ft 3<sup>3</sup>/<sub>8</sub> in (1 m) between you and your subject. However when the zoom is at the wide-angle position, you can focus on a subject as close as 3<sup>3</sup>/<sub>8</sub> in (1 cm).
- Image resolution is slightly lower when the magnification is greater than 10×.
- You cannot use digital zoom when the multi-image screen is set. The display becomes “— — —”.

## Using the LCD Screen

### Open the LCD screen

Push the LCD panel OPEN button and open the panel by pulling it away from the camera. This automatically switches the LCD screen on and the viewfinder off. When you close the LCD panel, the LCD screen automatically switches off and the viewfinder switches back on.

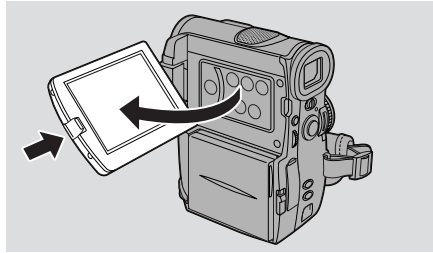

E

### Changing the angle of the LCD screen

You can choose the angle of the screen that suits you best by opening and rotating the screen, also you can rotate the LCD screen so that faces in the direction of the lens ( 23).

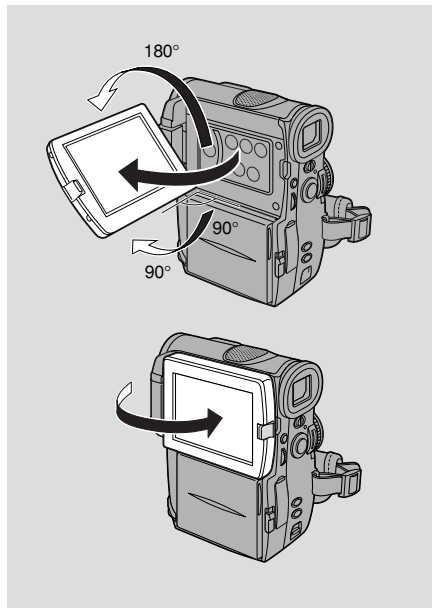

Mastering  
the Basics

You can also push the panel flat against the camera until it is flush with the side, with the screen facing outwards.

## E



- Avoid touching the LCD screen when moving the LCD panel.
- Do not hold the camera by the LCD panel or the viewfinder.
- Make sure you open the LCD panel at 90°, before attempting to rotate it.
- Always rotate the LCD panel vertically into place, before closing it or pushing it flat against the side of the camera.
- Always fully close the LCD panel until it clicks securely.
- Be careful not to leave the LCD, viewfinder or lens exposed to direct sunlight outdoors or in a window. Doing so could cause damage.
- Bright light falling on the LCD screen may cause glare that makes it difficult for you to view the image. In this case, switch to using the viewfinder. You are also able to adjust the brightness of the screen (see “Adjusting the LCD screen” below).

### Adjusting the LCD screen



You can adjust the brightness of the LCD screen.

Mastering  
the Basics

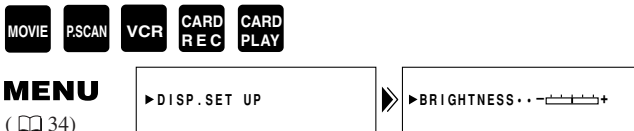

**Open the menu and select DISP.SET UP from the menu. Then select BRIGHTNESS, adjust the level with the SELECT dial and close the menu.**

A bar showing the level appears in the display for 4 seconds.

- Turn the SELECT dial up to make the display brighter.
- Turn the SELECT dial down to make the display darker.



- The camera will remember your brightness setting even after you turn it off.
- The brightness of the LCD does not affect that of the recorded images or the viewfinder.

#### About the LCD Screen

The LCD screen built into this camcorder is a high precision product. However, small black dots or bright points of light (red, blue or green) may appear constantly on the LCD screen. This is not a malfunction of the LCD screen and they are not recorded on the tape. (Effective dots: more than 99.99%)

## Allowing the subject to monitor recording



E

When you turn the LCD panel so that it faces the same direction as the lens, you can watch yourself during recording or let your subject monitor recording. The viewfinder is also activated when the panel is in this position. Extend the viewfinder.

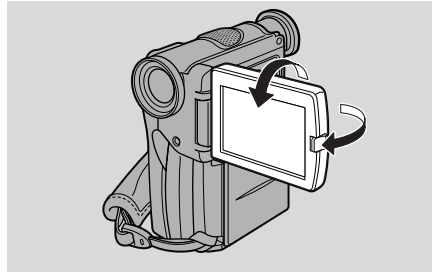

- You can choose the display style, reversed (mirror on) or not (mirror off). The recording itself is unaffected regardless of which one you choose.



### MENU

( 34)



To turn the mirror mode off, open the menu and select **DISP.SET UP**. Then select **MIRROR**, set it to **OFF** and close the menu.

The indicators that appear in the LCD display when **MIRROR** is turned on:

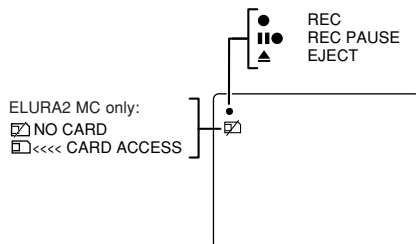



- These and all other indicators appear normally in the viewfinder.

Mastering  
the Basics

## Playing Back a Cassette

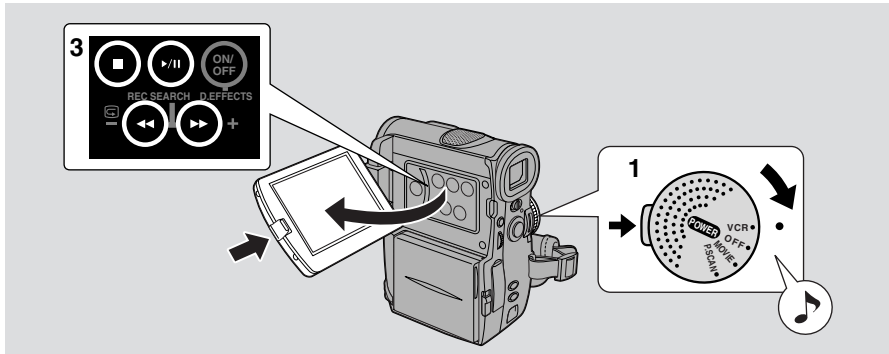
E



You can use the LCD screen for instant, on-the-spot playback. The camera also plays back the sound track via the built-in speaker (  27).

- When you play back a tape, you can also close the LCD panel with its screen side facing up. Operate the camera with the wireless controller when the LCD panel is in this position.
- When you're using the viewfinder to view playback, close the LCD panel.

To play back your recordings on a TV, see p. 28.

To use the wireless controller, see p. 42.



- To avoid accidental recording, make sure that you slide the tab on the cassette so that it exposes the hole (the switch position is usually labeled SAVE or ERASE OFF).

### 1. Attach a power source and turn the POWER dial to VCR.

- The power indicator lights up green.

### 2. Load the cassette.

### 3. Press the ► (play) button to start playback.

- To end playback, press the ■ (stop) button.
- To wind the tape forwards, stop playback and press the ►► (fast forward) button.
- To wind the tape backwards, stop playback and press the ◀◀ (rewind) button.
- If the playback picture is rough (mosaic-like noise), clean the video heads using a Canon DVM-CL Digital Video Head Cleaning Cassette or a commercially available digital video head cleaning cassette.



## Other playback modes

**E**

### Playback pause

Press the **||** (pause) button. To resume normal playback, press it again, or press the **▶** (play) button. The camera automatically goes into stop mode after about 5 minutes' playback pause.

### Fast forward playback

To play back the recording at about 9.5 times normal speed, press and hold the **▶▶** (fast forward) button during normal playback or press and hold the **▶▶** (fast forward) button during normal fast forward.

### Rewind playback

For reverse playback at about 9.5 times normal speed, press and hold the **◀◀** (rewind) button during normal playback or press and hold the **◀◀** (rewind) button during normal rewind.

  
Mastering  
the Basics

## E

## Special playback



### Frame Advance

To play back frame by frame, press the +/▶▶ button repeatedly during playback pause.  
Press and hold to play back continuous frame advance.

### Frame Reverse

To play back in reverse frame by frame, press the -/◀◀ button repeatedly during playback pause.  
Press and hold to play back continuous frame reverse.

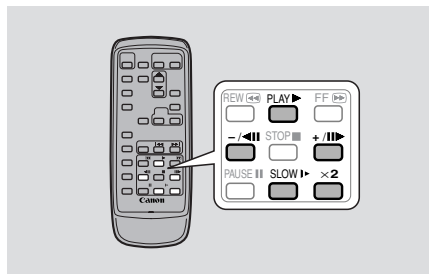

### Slow Forward Playback

To play back at about 1/5 normal speed, press the SLOW ▶ button during normal playback.

Press the PLAY ▶ button to return to normal playback.

- The camera automatically returns to playback after about 30 seconds of slow playback.

### Slow Reverse Playback

To play back in reverse at about 1/5 normal speed, press the -/◀◀ button and then the SLOW ▶ button during normal playback.

Press the PLAY ▶ button to return to normal playback.

- The camera automatically returns to ×1 reverse playback after about 30 seconds of slow playback.

### Reverse Playback

To play back in reverse at normal speed, press the -/◀◀ button during normal forward playback.

Press the PLAY ▶ button to return to normal forward playback.

### Forward ×2 Playback

Press the ×2 button during normal playback.

Press the PLAY ▶ button to return to normal playback.

### Reverse ×2 Playback

Press the -/◀◀ button and then the ×2 button during normal playback.

Press the PLAY ▶ button to return to normal playback.



- Mosaic-like noise appears on the screen during some of the special playback modes.
- There's no audio during special playback.

## Built-in speaker

**E**

The camcorder has a built-in speaker so you can review the sound track alongside the picture during playback.

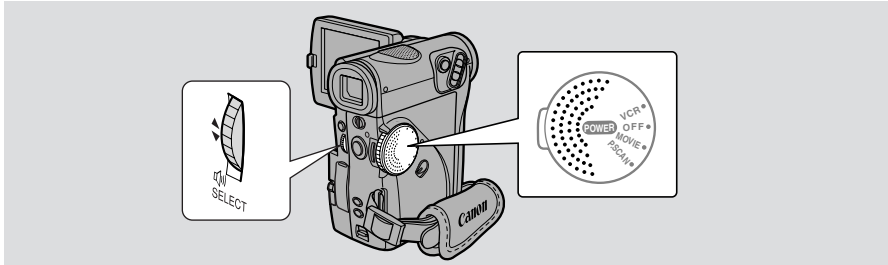

Adjust the speaker volume by turning the SELECT dial.

- Turn the SELECT dial up to increase the volume, and down to lower the volume.
- A VOLUME bar appears in the display to indicate the current volume. It disappears in 4 seconds.
- You can turn off the volume completely by turning the SELECT dial down until OFF appears.
- You can also adjust the headphone volume separately from the built-in speaker. (Use the DU-300 Docking Unit to connect the headphones, p.65.)
- The levels you adjust for the built-in speaker and headphones are memorized separately. The camera remembers your levels even if you turn the camera off and back on again.



- The speaker turns off when the camera is set to any mode other than VCR or when you use headphones.
- Sometimes audio may sound distorted when the volume is turned up high. If this happens, turn down the volume.

## Connections for Playback on a TV Screen

E

You can connect the camera to a TV or VCR in order to play back your recordings. You will need to attach a power source to the camera ( 11). Power off all devices before starting the connections.

See your TV or VCR instruction manual for further details.

### Attaching the DU-300 Docking Unit

The DU-300 Docking Unit is fitted with microphone, headphone, S-video and LANC terminals. Connect it to the base of the ELURA2/ELURA2 MC via the docking unit attachment terminal.

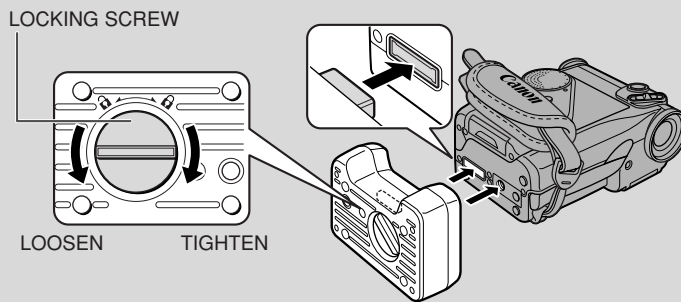

1. **Make sure that the ELURA2/ELURA2 MC is switched off.**
2. **Align the terminals of the docking unit and the camera.**
3. **Push the docking unit onto the camera and turn the locking screw clockwise to fix it securely onto the base.**
  - To remove, turn the locking screw counter-clockwise and pull the docking unit from the base of the camera.

### DU-300 Docking Unit

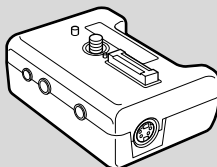

## Specifications

<b>S-video terminal input/output</b>	1 Vp-p (Y signal), 0.286 Vp-p (C signal)
<b>Microphone terminal</b>	ø 3.5 mm stereo minijack, -57 dBV (with 600 ohm mic)/at least 5 kohms
<b>Headphone terminal</b>	ø 3.5 mm stereo minijack
<b>LANC  terminal</b>	ø 2.5 mm mini minijack
<b>Dimensions</b>	3 × 1 1/8 × 2 1/4 in (77 × 29 × 56 mm)
<b>Weight</b>	1 3/4 oz (50 g)

Weight and dimensions are approximate.

Errors and omissions excepted.

Subject to change without notice.

### If your TV (or VCR) has an S (S1) -video input terminal

For higher picture quality, we recommend playing back recordings on a TV with an S (S1) terminal. If you connect the camera to a TV with an S1 terminal or the Video ID-1 system, recordings made in the 16:9 mode for wide screen TVs will automatically play back in wide screen mode on the TV screen.

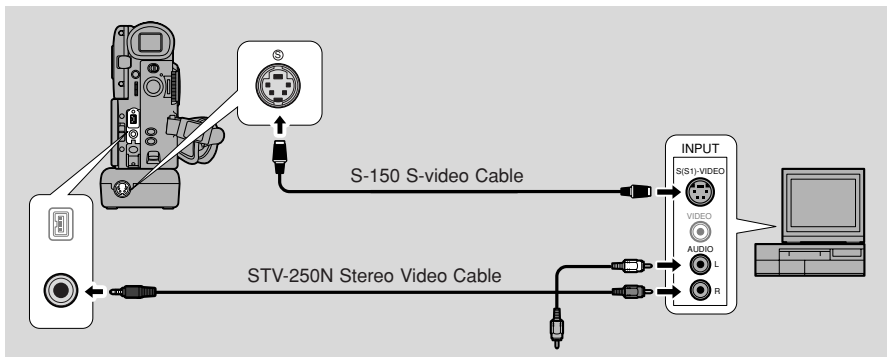

- Attach the DU-300 Docking Unit in order to use the S-video terminal (  28).
- Use the S-150 S-video Cable to connect the S-video terminals. Use the STV-250N Stereo Video Cable to connect the AUDIO terminals. Connect the white plug to the white AUDIO terminal **L** (left). Connect the red plug to the red AUDIO terminal **R** (right). Do not connect the yellow plug.
- If you are connecting the camera to a TV, set the TV/VIDEO selector on the television to VIDEO.
- If you are connecting the camera to a VCR, set the input selector on the VCR to LINE.

E

Mastering  
the Basics

## E

### If your TV (or VCR) has audio/video input terminals

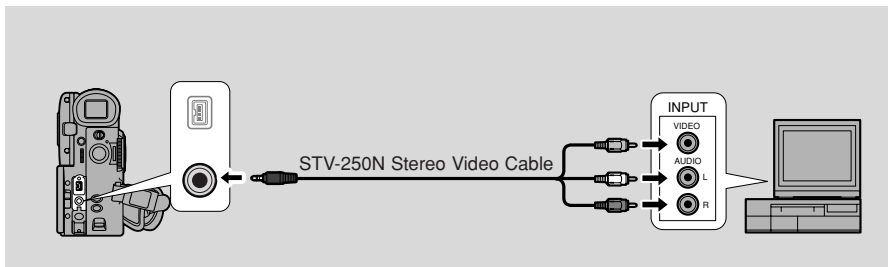

- Connect the camera using the STV-250N Stereo Video Cable. Connect the white plug to the white audio terminal **L** (left). Connect the red plug to the red audio terminal **R** (right). Connect the yellow plug to the yellow video terminal **VIDEO**.
  - If you are connecting the camera to a TV, set the TV/VIDEO selector on the television to VIDEO.
  - If you are connecting the camera to a VCR, set the input selector on the VCR to LINE.
- 
- If you are going to use the TV as a monitor while you are shooting, remember to keep the TV volume turned down as long as the camera's audio terminals are connected. If the sound from the TV speakers is picked up by the microphone, an unpleasant high-pitched squeal, called feedback, may be produced.

## Tips for Making Better Videos

### Holding the camera

For maximum stability, grip the camera in your right hand and keep your right elbow pressed against your body. If necessary support the camera with your left hand. With practice, you will be able to operate the controls by touch, without taking your eye off the action.

- When holding the camera, be sure to avoid touching the lens and the microphone.

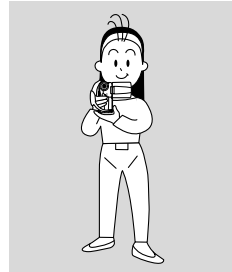

E

### Using a tripod

To prevent any unwanted movement, you can mount the camera on a tripod, (or any flat surface at a suitable height) and operate it with the wireless controller.

- When you are using a tripod, be careful not to leave the viewfinder exposed to bright sunlight or it may melt. (The light is concentrated by the viewfinder lens.)
- Make sure that the fastening screw of the tripod is no longer than 1/4 inch (5.5 mm), or it will damage the camera.

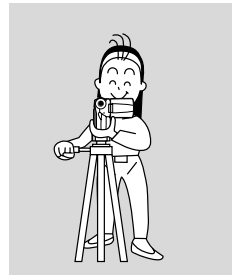

Mastering  
the Basics

### Composition

The most important element in the scene does not have to be in the center. For a more interesting picture, try to position your subject so it is slightly to one side. Leave some space on the side of the frame that the subject is facing or moving towards.



Don't cut off the top of the subject's head, and don't cut people off at the neck, hips or knees (move a little bit above or below).

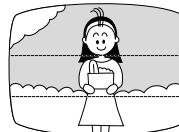

Watch out for distracting objects in the background.



## E

## Picture angle

Instead of zooming while recording, try to choose your picture angle before you begin. A good way to tell a story with video is to begin with a long shot that establishes the situation, and then move in with medium shots and close-ups to show the details. Remember to change your viewpoint for each shot.

Remember that any camera movement or change in picture angle should have a definite purpose. Avoid unnecessary or half-hearted movements.



Long shot



Medium shot



Close-up

## Camera moves

### Mastering the Basics

Use pans to record a landscape or follow a moving subject. Decide the area you want to cover and stand facing the end of your panning angle. Without moving your feet, turn your waist to the starting position. Start recording, and after a few seconds begin to turn slowly from the waist. Hold the final image for a few seconds before you stop recording.

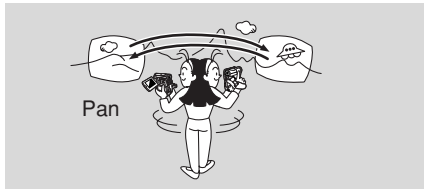

Tilt the camera up to exaggerate the height of the subject. Tilt down from the top of a building, for example, as an introduction to subjects at the bottom.





## Turning the Image Stabilizer Off



E

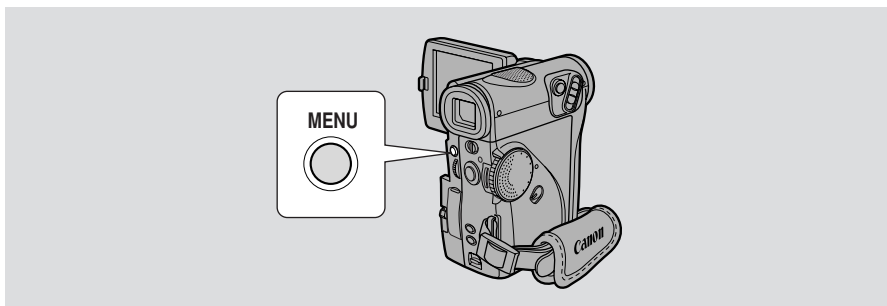

With most camcorders, even the slightest hand movements will be noticeable during telephoto recording. However, the ELURA2/ELURA2 MC's image stabilizer allows you to obtain steady recordings even at high magnification.



### MENU

( 34)

▶CAM.SET UP

▶IMAGE S. ( ) · ON

**To turn the image stabilizer off, open the menu and select CAM.SET UP. Then select IMAGE S., set it to OFF and close the menu.**

- The ( ) mark disappears from the display when the stabilizer is off.
- The image stabilizer cannot be turned off when the program selector is set to the □ (Easy Recording) position.



- The image stabilizer is designed to deal with a normal degree of camera shake.
- Keep the image stabilizer turned off when the camera is mounted on a tripod.
- The image stabilizer is not as effective as usual during the Low Light mode.

Using the Full  
Range of Features

## Using the Menus



**E**

Many of the camera's advanced functions are selected from menus which appear in the display.

There are 4 main menus:

CAM. MENU	Camera menu	( 36)
VCR MENU	VCR menu	( 37)
C.REC MENU	Card record menu	( 39) (ELURA2 MC only)
C.PLAY MENU	Card play menu	( 40) (ELURA2 MC only)

### ● CAM. MENU

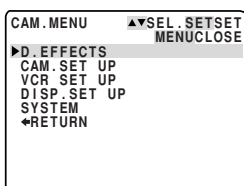

### ● VCR MENU

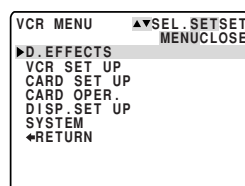

### ● C. REC MENU (ELURA2 MC only)

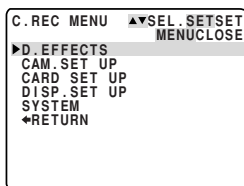

### ● C. PLAY MENU (ELURA2 MC only)

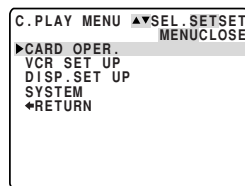

Using the Full  
Range of Features

## Selecting from the Menus



The following icons are used throughout this manual to show the setting for the POWER dial:

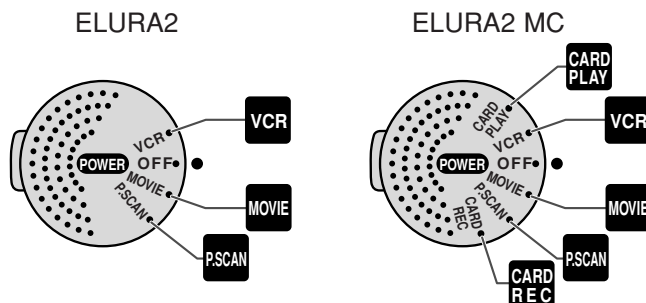

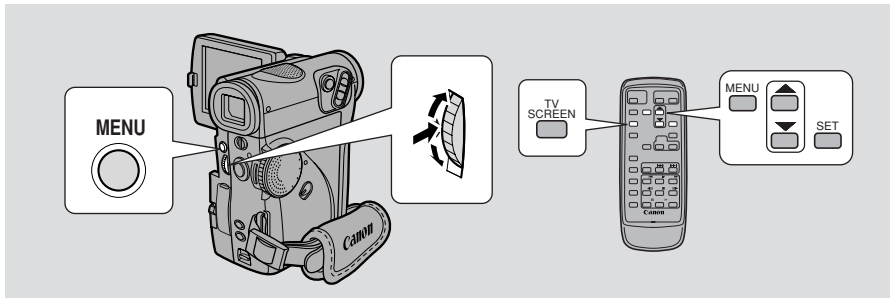

E

1. Turn the **POWER** dial to the appropriate setting.
2. Press the **MENU** button to open the menu.
  - One of the main menus appears, according to the **POWER** dial setting.
3. Turn the **SELECT** dial and move the arrow to the desired submenu.
4. Press the **SELECT** dial in to select.
  - The submenu appears.
5. Turn the **SELECT** dial and move the arrow to the desired function.
6. Press the **SELECT** dial in to select.
  - The function and its settings only appear.
7. Turn the **SELECT** dial and move the arrow to the desired setting.
  - If you are setting a function other than the white balance or shutter speed, the function will be set if you close the menu here.
8. Press the **SELECT** dial in to select.
  - The function is set and you return to the submenu.
9. Turn the **SELECT** dial and move the arrow to **← RETURN**.
10. Press the **SELECT** dial in to select.
  - You return to the main menu.
11. Press the **MENU** button.
  - The main menu disappears.



- Pressing the **MENU** button at any time closes the menu.
- Selecting **← RETURN** takes you back one menu, or closes the main menu.
- Available menu items appear in yellow. Items that are unavailable, due to the tape or card situation or the settings of other menu items, appear in purple.
- You may often find it convenient to use the wireless controller to move around the menus. Press its **MENU** button to open/close the menu and use the arrow keys in place of turning the **SELECT** dial. Push the **SET** button to select.
- Pressing the start/stop button or the **PHOTO** button will close the menu and start recording.
- You can display the menus on a connected TV screen by turning **TV SCREEN** ( 132) on through the menu or using the wireless controller's **TV SCREEN** button. See p. 28 for TV hookup instructions.

Using the Full  
Range of Features

**E**

**List of Menu**



Turn to the appropriate page for a detailed explanation of each function.

**● CAM. MENU**

Appears when the POWER dial is set to **MOVIE** or **PSCAN**.  
There are 5(+1) submenus within the CAM. MENU.

- ① To digital effects submenu
- ② To camera set up submenu
- ③ To VCR set up submenu
- ④ To display set up submenu
- ⑤ To system submenu
- ⑥ Close main menu

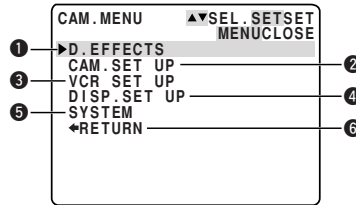

**① Digital effects submenu**

- ① Digital effects select ..... 61
- ② Fader ..... 61
- ③ Effect ..... 62
- ④ Multi-image screen speed ..... 63
- ⑤ Multi-image screen split ..... 63
- ⑥ To card mix menu (ELURA2 MC only) ..... 107
- ⑦ Return

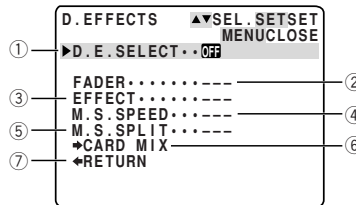

**Card mix submenu (⑥)**  
(ELURA2 MC only)

- ⑧ Mix type ..... 106
- ⑨ Mix level ..... 107
- ⑩ Return

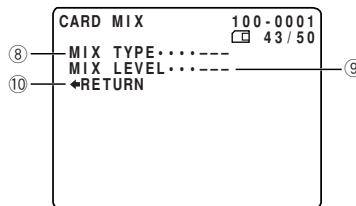

**② Camera set up submenu**

- ⑪ Shutter speed ..... 70
- ⑫ Digital zoom ..... 20
- ⑬ Image stabilizer ..... 33
- ⑭ 16:9 effect ..... 18
- ⑮ White balance ..... 73
- ⑯ Return

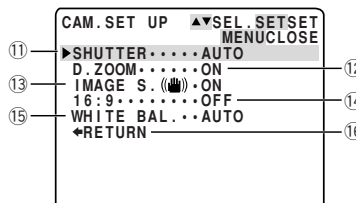

Using the Full Range of Features



### 3 VCR set up submenu

- 17 Record mode..... 18
- 18 Wind screen ..... 66
- 19 Audio mode ..... 65
- 20 Return

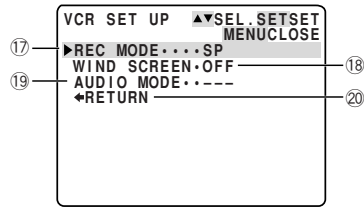

### 4 Display set up submenu

- 21 Brightness ..... 22
- 22 Mirror mode..... 23
- 23 TV screen..... 132
- 24 Date/time display ..... 47
- 25 Return

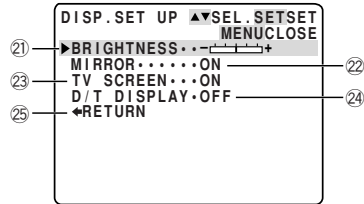

### 5 System submenu

- 26 Wireless controller..... 43
- 27 Tally lamp ..... 44
- 28 Beep ..... 19
- 29 Time zone/Daylight saving time..... 45
- 30 Date/time set..... 47
- 31 Return

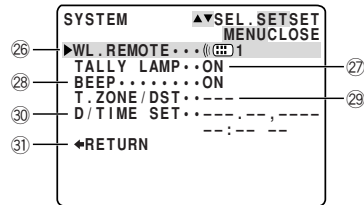

Using the Full Range of Features

## ● VCR MENU

Appears when the POWER dial is set to **VCR**.  
There are 6 submenus within the VCR MENU.

- 1 To digital effects submenu
- 2 To VCR set up submenu
- 3 To card set up submenu (ELURA2 MC only)
- 4 To card operations submenu (ELURA2 MC only)
- 5 To display set up submenu
- 6 To system submenu
- 7 Close main menu

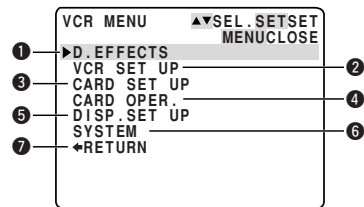

**E**

**1 Digital effects submenu**

- ① Digital effects select ..... 61
- ② Fader ..... 61
- ③ Effect..... 62
- ④ Multi-image screen speed..... 63
- ⑤ Multi-image screen split..... 63
- ⑥ Return

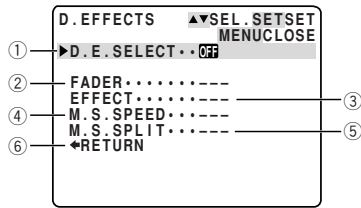

**2 VCR set up submenu**

- ⑦ Record mode..... 18
- ⑧ Output channel..... 92
- ⑨ Audio dubbing ..... 89
- ⑩ Wind screen ..... 66
- ⑪ Audio mode ..... 65
- ⑫ Return

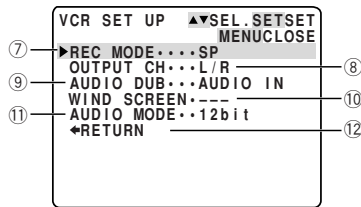

**3 Card set up submenu (ELURA2 MC only)**

- ⑬ Image quality ..... 94
- ⑭ File numbers ..... 96
- ⑮ Return

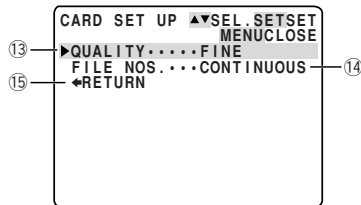

**4 Card operations submenu (ELURA2 MC only)**

- ⑯ Copy from cassette to card . 109
- ⑰ Return

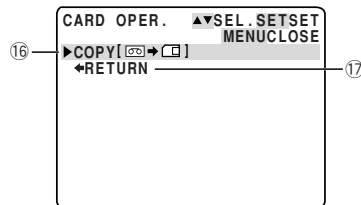

Using the Full Range of Features



### 5 Display set up submenu

- 18 Brightness ..... 22
- 19 Displays ..... 132
- 20 6-second auto date ..... 77
- 21 Data code ..... 76
- 22 Date/time select ..... 75
- 23 Return

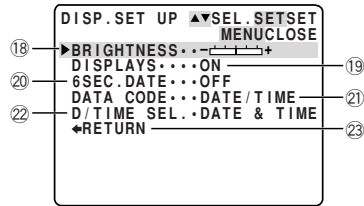

### 6 System submenu

- 24 Wireless controller ..... 43
- 25 Beep ..... 19
- 26 Return

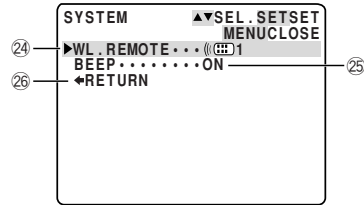

## ● C. REC MENU (ELURA2 MC only)

Appears when the POWER dial is set to **CARD REC**.  
There are 5 submenus within the C. REC MENU.

- 1 To digital effects submenu
- 2 To camera set up submenu
- 3 To card set up submenu
- 4 To display set up submenu
- 5 To system submenu
- 6 Close main menu

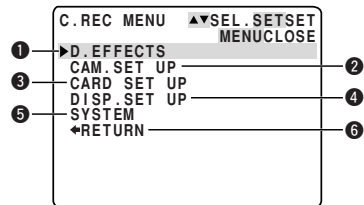

### 1 Digital effects submenu

- 1 Digital effects select ..... 61
- 2 Effect ..... 62
- 3 Multi-image screen speed ..... 63
- 4 Multi-image screen split ..... 63
- 5 Return

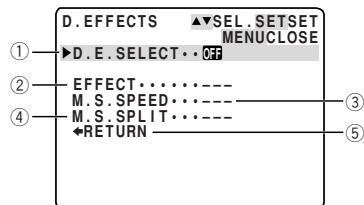

Using the Full Range of Features

**E**

**2 Camera set up submenu**

- ⑥ Shutter speed..... 70
- ⑦ Digital zoom..... 20
- ⑧ Image stabilizer..... 33
- ⑨ White balance ..... 73
- ⑩ Return

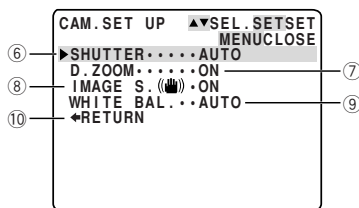

**3 Card set up submenu**

- ⑪ Image quality ..... 94
- ⑫ File numbers ..... 96
- ⑬ Shutter sound ..... 96
- ⑭ Return

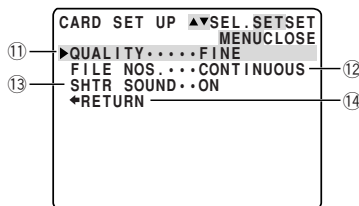

**4 Display set up submenu**

- ⑮ Brightness ..... 22
- ⑯ Mirror mode..... 23
- ⑰ TV screen..... 132
- ⑱ Date/time display ..... 47
- ⑲ Return

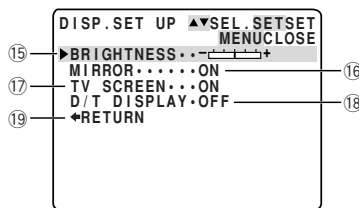

**5 System submenu**

- ⑳ Wireless controller..... 43
- ㉑ Beep ..... 19
- ㉒ Time zone/Daylight saving time ..... 45
- ㉓ Date/time set ..... 47
- ㉔ Return

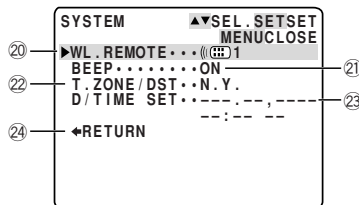

Using the Full Range of Features

**● C. PLAY MENU (ELURA2 MC only)**

Appears when the POWER dial is set to **CARD PLAY**.  
There are 4 submenus within the C. PLAY MENU.

- ① To card operations submenu
- ② To VCR set up submenu
- ③ To display set up submenu
- ④ To system submenu
- ⑤ Close main menu

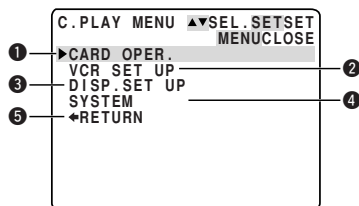





### 1 Card operations submenu

- ① To index ..... 102
- ② To image protect ..... 103
- ③ To print mark ..... 111
- ④ Copy from card to cassette ..... 110
- ⑤ Image erase ..... 104
- ⑥ Format ..... 112
- ⑦ Return

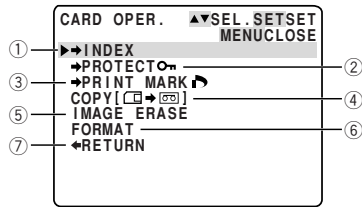

### 2 VCR set up submenu

- ⑧ Record mode ..... 18
- ⑨ Return

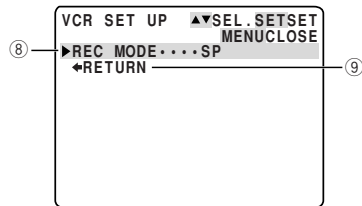

### 3 Display set up submenu

- ⑩ Brightness ..... 22
- ⑪ Displays ..... 132
- ⑫ Date/time select ..... 75
- ⑬ Return

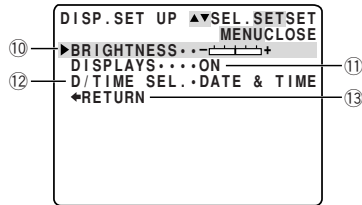

### 4 System submenu

- ⑭ Wireless controller ..... 43
- ⑮ Beep ..... 19
- ⑯ Return

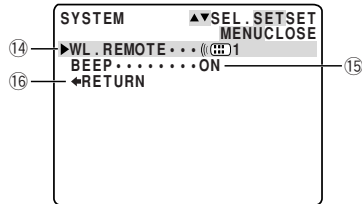

Using the Full Range of Features

## Using the Wireless Controller/Tally Lamp

E

The supplied wireless controller can operate the camera from a distance of up to 16 feet (5 m). Point it at the camera's remote sensor while you press the buttons. The camera's tally lamp will light up when it receives signals from the wireless controller.

There are some functions that cannot be operated without the wireless controller:

- Special playback ( 26)
- Photo/date search ( 78)
- Zero set memory ( 79)
- Audio mix ( 91)
- A/V insert ( 85)
- Audio dubbing ( 88)

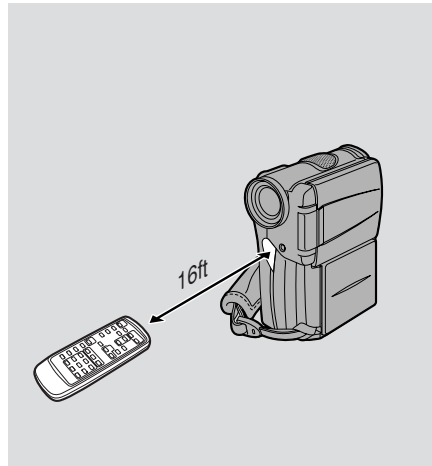

### Inserting batteries

Insert two AA batteries, following the  $\oplus$  and  $\ominus$  markings. Be careful not to reverse the polarity of the batteries.

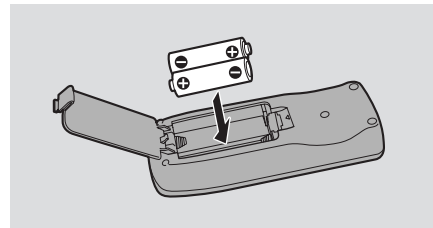

- When using the wireless controller in brightly lit places or outdoors, the effective range will be less.
- The camera may have difficulty picking up the remote control signals at extremely close range.
- Do not leave the controller exposed to direct sunlight, or in hot or humid places.
- When the batteries run out, replace them both together.
- If the wireless controller doesn't work, see p. 43.

Using the Full  
Range of Features

## When Operating 2 Canon DV Camcorders (Remote Sensor Mode)



E

To prevent interference from other Canon wireless controllers being used nearby, there are 2 remote sensor modes and an off setting. The wireless controller and the camera have to be set to the same mode in order to be compatible.

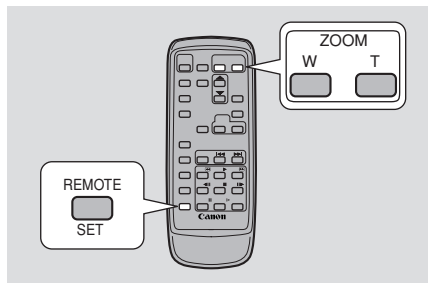

The wireless controller and the camera have been preset to mode 1. If you change the mode on the camera, be sure to change the mode on the wireless controller to the same mode.



**MENU**  
( [ ] 34)



1 : Mode 1  
 2 : Mode 2  
**OFF** : Sensor off

To turn the remote sensor off:

**Open the menu and select SYSTEM. Then select WL.REMOTE, set it to OFF and close the menu.**

- appears in the display.

To change the mode...

...on the camera:

**Open the menu and select SYSTEM. Then select WL.REMOTE, set it to 1 or 2 and close the menu.**

- The selected mode will appear on the display for 4 seconds.

...on the wireless controller:

**Press and hold the REMOTE SET button on the wireless controller. Simultaneously press the ZOOM W button for mode 1 or the ZOOM T button for mode 2. Continue to press simultaneously for over 2 seconds.**

- Be sure to set the wireless controller to the same mode as the camera.

Using the Full  
Range of Features

**E****If your wireless controller isn't working:**

Make sure the camera and the wireless controller are both set to the same mode. Check the mode the camera is set to by pushing any button other than the REMOTE SET button on the wireless controller. The camera's mode appears in purple for about 4 seconds. Set the wireless controller's mode accordingly by pressing the aforementioned button combinations. If the wireless controller still doesn't work, change the batteries.



- The mode the camera is set to also appears for 4 seconds when you turn the power on.

**Turning off the tally lamp**

The tally lamp lets you know that the camera is recording, receiving signals from the wireless controller or counting down for the self-timer. However, its flashing may be reflected into the lens during close-up recording, or when recording through glass.

You may therefore decide to turn it off.

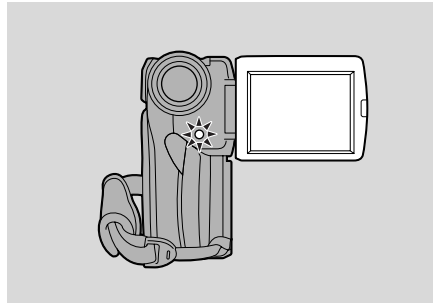

Using the Full  
Range of Features

**MENU**

( 34 )

▶ SYSTEM

▶▶ TALLY LAMP · · ON

**To turn the tally lamp off, open the menu and select SYSTEM. Then select TALLY LAMP, set it to OFF and close the menu.**

- The tally lamp no longer flashes during recording, but it will still light up when the camera receives a signal from the wireless controller and during the self-timer countdown.

## Setting the Date and Time

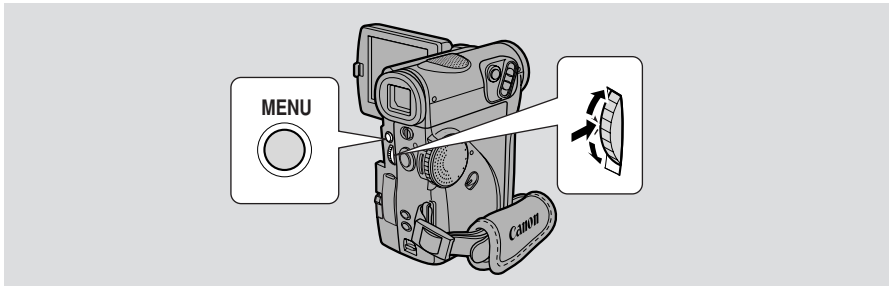

The date and/or time display forms part of the data code. You can choose to display or hide it during playback ( 75).

Set the date and time display when you first start using your camera. Install the backup battery before you begin ( 119).

- Before you start setting the date and time, select your home time zone from the menu.

### Setting the time zone/daylight saving time



**MENU**  
( 34)

▶SYSTEM

▶T.ZONE/DST..N.Y.

1. **Open the menu and select SYSTEM.**
2. **Select T.ZONE/DST.**
  - The time zone display appears on the screen.
  - Your camcorder's time zone is factory-preset to New York. If you are at another time zone, select your time zone first and daylight saving time (DST) setting if necessary.
3. **Move up or down the list of time zones with the SELECT dial. Select the option that represents your time zone.**
  - If you are now in daylight saving time, select the time zone with the daylight saving time mark next to the area.
4. **Close the menu.**

Using the Full  
Range of Features

E

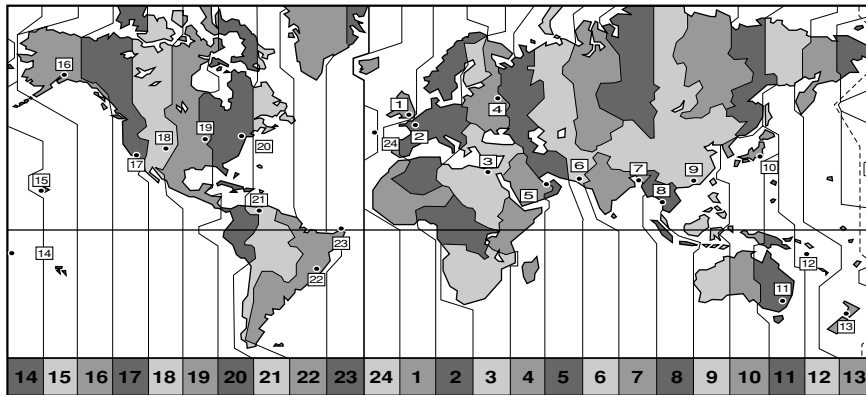

No.	Time zone	No.	Time zone
1	LONDON	13	WELLGTM (Wellington)
2	PARIS	14	SAMOA
3	CAIRO	15	HONOLU (Honolulu)
4	MOSCOW	16	ANCHOR (Anchorage)
5	DUBAI	17	L.A. (Los Angeles)
6	KARACHI	18	DENVER
7	DACCA	19	CHICAGO
8	BANGKOK	20	N.Y. (New York)
9	H. KONG (Hong Kong)	21	CARACAS
10	TOKYO	22	RIO (Rio de Janeiro)
11	SYDNEY	23	FERNAN. (Fernando de Noronha)
12	SOLOMON	24	AZORES

### Using the Full Range of Features



- After you have selected your time zone and set the date and time, when you travel to another time zone, there is no need to reset the date and time. Just set the time zone to your destination and the camera's clock will automatically change to display the correct time for your destination.
- The camera automatically accounts for the number of days in a month and leap year.

## Setting the clock



E

After you set the date and time, the date/time and home time zone will be displayed for about 4 seconds each time you turn the power on.



### MENU

( 34)

▶ SYSTEM

▶▶ D/TIME SET...JAN. 1,2000  
12:00 AM

1. Open the menu and select **SYSTEM**.
2. Select **D/TIME SET**.
  - The year display starts to flash.
3. Turn the **SELECT** dial up and down to change the year. Press the dial in to move to another part of the display.
  - Once you move from the year, the next part of the display starts flashing.
4. Set the month, day, hours, and minutes in the same way.
5. Press the **MENU** button when finished, and to start the clock.



- To make a change to part of the date and time, press the **SELECT** dial in at step 3 to move to the part to be changed. Turn the dial to make the change, then close the menu.
- The date can be set to any year between 2000 and 2030.
- If you press the **MENU** button in the middle of setting the date and time, you leave the menu, and the clock starts.
- If you press the **SELECT** dial in after setting the minutes you can set the date and time again from the start.

## Date and time display



You can choose to display or hide the date and time display during recording. When the date and time display is set to **ON**, the date and time show in the lower left-hand corner of the display but the time zone disappears in about 4 seconds. The large, 4-second display will no longer appear when you turn on the power. It is not automatically superimposed on your recordings.



### MENU

( 34)

▶ DISP.SET UP

▶▶ D/T DISPLAY·OFF

To turn it on, open the menu and select **DISP.SET UP**. Then select **D/T DISPLAY**, set it to **ON** and close the menu.

Using the Full  
Range of Features

## Recording in Progressive Scan Mode (Digital Motor Drive)

**E**

In Progressive Scan Mode, the ELURA2/ELURA2 MC's Digital Motor Drive records 30 full frame images per second, continuously, for superior quality frames. Use Progressive Scan Mode for fast moving scenes and moments that are hard to capture just taking a still photo. Check your tennis or golf swing, for example, or capture the smile of a baby. ELURA2: You can then record selected still images onto a floppy disk with the Floppy Disk Still Image Recorder FR-100 (optional) and easily transfer them to a personal computer for print out, making personalized postcards, calendars, etc. ELURA2 MC only: If you plan on copying still images to a MultiMediaCard later, we recommend recording in Progressive Scan Mode.



Using the Full  
Range of Features

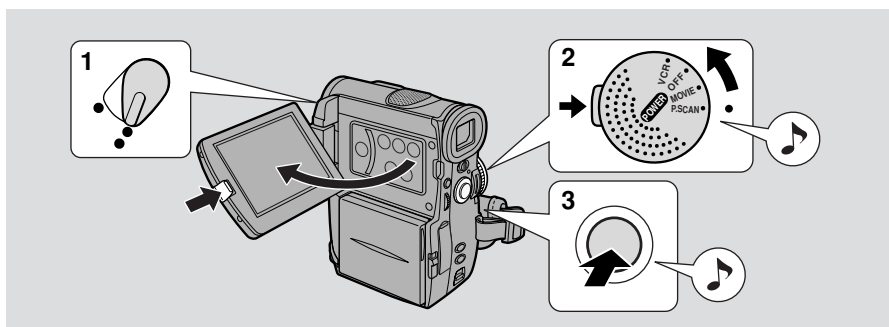

1. Set the **POWER** dial lock lever to the ●● position.
2. Turn the **POWER** dial to **P.SCAN**.
  - The power indicator lights up red.
  - PRO.SCAN appears in the display.
3. Press the **start/stop button** to begin recording.  
When you finish recording, return the lock lever to the ● position.



- Progressive scan video may appear slightly jerky during normal playback. Some recording conditions may be more suitable for MOVIE than P. SCAN.
- The camera will turn itself off if you leave it in record pause mode for more than about 5 minutes. To return to record pause mode, set the **POWER** dial to OFF and then back to P. SCAN.



## Taking Still Pictures to a Cassette



ELURA2 MC only: To take still images on a MultiMediaCard, see p. 97.

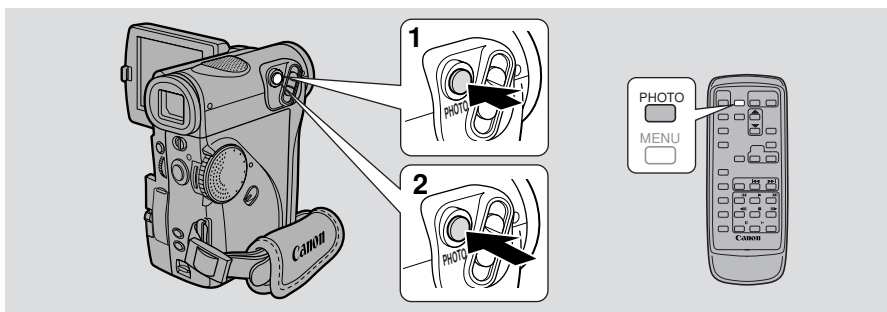

You can record still pictures like a photograph. The camera records the picture and sound to tape for approximately 6 seconds. The exposure is automatically adjusted.

Your still photos can be transferred to a PC for image enhancement and printout.

ELURA2: Record still photos onto a floppy disk with the optional Floppy Disk Still Image Recorder FR-100 (□ 51) for transfer to a PC.

ELURA2 MC only: Copy still photos automatically to a MultiMediaCard for transfer to a PC (□ 109).

Also, starting your shooting with a still photo makes it easy to find the beginning again later with the Photo Search function (□ 78).

Also, starting your shooting with a still photo makes it easy to find the beginning again later with the Photo Search function (□ 78).

You can take a still picture at any time during regular video recording, or you can put the camcorder into record pause mode first, then take a still picture.



During record mode

**Press the PHOTO button fully down and the still picture will be taken immediately.**

- The camera takes the image immediately, and then records the “photo” to the tape for approximately 6 seconds. During this time the camera also records the sound, and the display shows the still picture.
- A counter display appears, and counts up to 6 seconds as the camcorder records the picture.
- The camera returns to record pause mode.

During record pause mode





**1. Press the PHOTO button halfway down and hold it:**

- “PHOTO” flashes at the bottom right of display.
- Exposure is locked.
- During autofocus ● flashes white in the display as the camcorder adjusts the focus and it is displayed continuously as a green mark when the camera is ready to take the still picture.

E

Using the Full  
Range of Features

E

- If the subject is unsuitable for autofocus (  125), the camera may not be able to focus, and  may continue to flash white in the display. Adjust the focus manually with the SELECT dial.
- If you are using manual focus (  72), the  mark starts as a continuous green mark. Focus with the SELECT dial.

## 2. Press the PHOTO button fully down to take the still picture.

- The camera takes the image immediately, and then records the “photo” to the tape for approximately 6 seconds. During this time the camera also records the sound, and the display shows the still picture.
- A counter display appears, and counts up to 6 seconds as the camcorder records the picture.  disappears from the display.
- The camera returns to record pause mode.



- The camera automatically returns to record pause mode after recording a still image for approximately 6 seconds. If a cassette is inserted and you turn the POWER dial to OFF during those approximately 6 seconds, the camera will respond only after recording is complete.
- The wireless controller’s PHOTO button has no half-way setting. Press the button fully and the camera immediately takes the “photo”.
- Only take “photos” where it is bright enough to see the image in the display.
- If you want to use an effect, make sure you set it before you take your picture.

Using the Full  
Range of Features

## Transferring Still Pictures to a PC with the FR-100 (optional)

### -For ELURA2 -

The Floppy Disk Still Image Recorder FR-100 captures images taken with the camera, compressing them in JPEG format and recording them as still images onto a floppy disk.

E

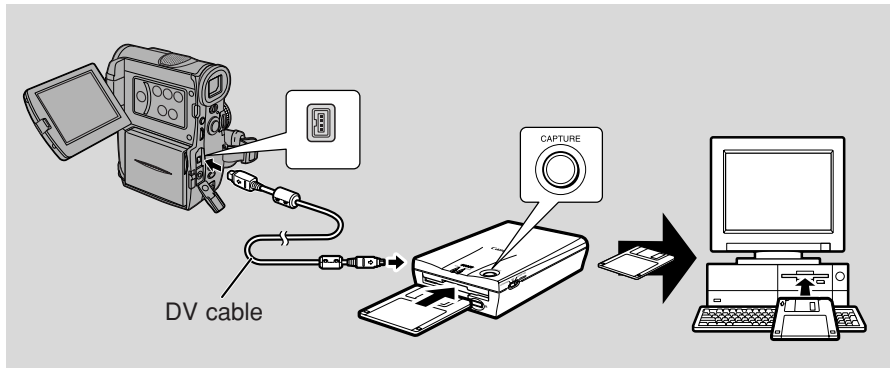

1. Connect the power sources for the camera and the FR-100.
2. Turn the camera's POWER dial to VCR, and connect the camera and the FR-100 with the DV cable (supplied with the FR-100).
3. Insert a floppy disk into the FR-100.
4. Play back your cassette in the camera and search for the image you want to capture. Find exactly the frame you want by using frame advance/reverse ( 26).
5. Press the FR-100's CAPTURE button to record the image onto the floppy disk.
6. After you have finished recording images, remove the floppy disk and insert it into your PC's disk drive.



- For full details of how to use the FR-100, refer to its instruction manual.

Using the Full  
Range of Features

## Searching and Reviewing While Recording

E

### Record search



When the camera is in record pause mode, you can use record search to play the tape forwards or backwards to find the point where you want to start or resume recording. This is useful when you want to add a new scene to a previously used cassette. By using record search, you can ensure a smooth, noise-free join between the new scene and the old one.

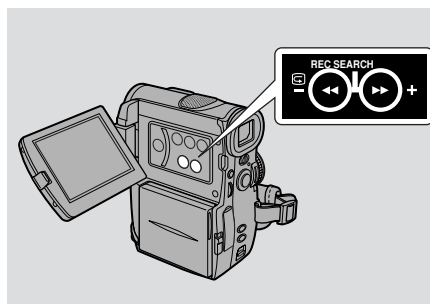

1. **Press and hold the REC SEARCH + or – button on the camera while you check the picture in the display.**
  - The + button plays the recording forwards and the – button plays it backwards.
2. **Release the button when you find the point where you want to start recording.**
  - The camera returns to record pause mode.

### Record review



When the camera is in record pause mode, you can use record review to play back the last few seconds of your recording and then return automatically to record pause mode. You can quickly make sure that a scene has recorded properly and then go on to shoot the next scene, without producing any noise in the picture.



1. **Press and release the  (record review) button while you check the picture in the display.**
  - The camera rewinds the tape, plays back the last few seconds, and returns to record pause mode.



- Noise may appear on the screen when you play the tape backwards.

## Using the Various Recording Programs

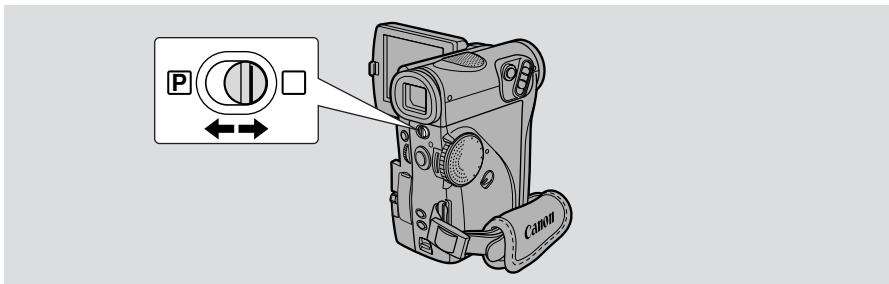

The camera provides you with a choice of 7 recording programs. They use different combinations of camera settings in order to adjust the exposure and other functions to match the recording situation.

- For simple point-and-shoot operation, select the Easy Recording program. Slide the program selector to the □ position.
- For normal shooting conditions, slide the program selector to P (program AE) mode. Open the program menu and select AUTO ( 54).
- For various other recording conditions, the camera has 5 more specialized AE (auto exposure) programs.

### Availability of functions in each recording program

Position of program selector							
Recording Program	□ (Easy Recording)	Auto	Sports	Portrait	Spotlight	Sand & Snow	Low Light
Shutter Speed	A	○	A				
Focus							○
Exposure							○
White balance							○
Image stabilizer (ON/OFF)		ON					
Digital effects	×						○
16:9	×						○

○ : Available      × : Not available      A : Automatic function only



Using the Full Range of Features

## E

Setting the program AE mode 

1. Slide the program selector to  (program AE) mode.
2. Press the SELECT dial in to display the program menu.
3. Turn the SELECT dial to move the arrow up or down the display.
4. Press the SELECT dial in to select the desired program.
  - The program will appear in the display.
5. Press the start/stop button to begin recording.



- The name of your selected recording program appears constantly on the left of the display, with the exception of Auto, which is displayed and then disappears after 4 seconds.
- Avoid changing programs during recording as the brightness of the image may change suddenly.
- The specialized AE programs are not suitable for all kinds of lighting. The image may flicker, or a bright line may appear on the screen if you use them in the wrong lighting conditions.
- If you switch the camera from the  program to the  program, the camera returns to the Auto program.
- When recording in dark places a bright light in the scene may cause a vertical light bar (“smear”) to appear. This is a normal feature of camcorders.



Using the Full Range of Features

## Easy Recording

The simplest way to use the camera is with the program selector set to the  position. The camera will take care of focus, exposure and other adjustments, leaving you free to point and shoot.



E

## Auto

This is the same as the Easy Recording program, except that you now have the option of using any of the camera's manual functions.



## Sports

This program is useful for recording high-speed sports scenes in brightly lit conditions. Normal playback will be slightly jerky, but you will get clear images which can be analyzed frame by frame during slow or paused playback.



Using the Full  
Range of Features

## Portrait

Use this program outdoors to make subjects stand out from a softened foreground and background. It works well for still-lives and close-ups. The effect is most noticeable when the zoom position is between the middle range and the telephoto end. Focus manually for maximum accuracy, and be careful when recording action scenes, as this program may cause fast moving objects to shudder.



**E****Spotlight**

This program is designed for recording spotlit scenes, such as on a stage. The exposure is automatically adjusted for glare-free recordings of subjects lit by a concentrated light source.

**Sand & Snow**

Use this program in places where the background is so bright that the subject appears underexposed in the display — a sunny beach or ski resort, for example. You may notice some shudder when recording moving subjects.

**Low Light**

This program allows you to record in dimly lit places. It is generally best used for close-ups of slow or stationary subjects, as moving subjects may leave a trailing after-image. However, you can take advantage of this to create special effects, by rapid zooming or by panning along with a moving subject. Picture quality will not be as good as in normal lighting conditions, and autofocus may not work as well as usual.





## Using Digital Effects

Use the camera's digital effects for more interesting productions. (ELURA2 MC only: See p.106 for CARD MIX)

E

- **Faders:** Start or end scenes on a tape with a fade to or from black (☞ 59). Fade Trigger, Wipe, Scroll, Mosaic Fade
- **Effects:** Add flavor to your recordings (☞ 60). Art, Black and White, Sepia, Mosaic
- **Multi-image Screen:** Divides the display to show 4, 9 or 16 still photos. Has 4 transition speed options: fast, moderate, slow and manual (☞ 63).

### Availability of digital effects by mode

\*ELURA2 MC only

	MOVIE	P. SCAN	PHOTO	VCR	CARD REC*	CARD PLAY*
Faders	○	○	×	○	×	×
Effects	○	○	○	○	○	×
Multi-image Screen	○	○	○	○	○	×

○ : Available    × : Not available

- The types of digital effects you are able to use depends on the setting of the POWER dial and the recording program.

Using the Full  
Range of Features

**E**

- When you do not want to use digital effects, set D.E.SELECT to OFF through the menu.
- The camera remembers your chosen digital effect setting until you change it.
- Digital effects can be selected but not operated on a blank blue screen (appears in VCR mode). The display continues to flash.
- Digital effects operated during VCR mode are not recorded onto the original tape.
- Digital effects can be added to another tape when dubbing using the A/V out terminal (VCR mode), but not the DV out terminal.
- You cannot operate digital effects while photo/date searching.
- If you slide the program selector to  (Easy Recording) while the digital effect display is flashing, it will disappear from the display and reappear when you return to  (program AE) mode.
- The digital effect display will flash for 2 seconds after setting, even if DISPLAYS is set to OFF in the menu.

## ● Faders

### Fade Trigger (FADE-T)

When you start recording, the scene gradually fades in from a black screen. When you stop recording, it gradually fades out.

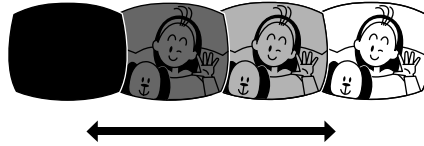

### Wipe (WIPE)

When you start recording, the picture begins as a thin vertical line in the center of the screen which gradually expands sideways until it fills the whole of the screen. When you end a scene, the image is wiped from both sides of the screen.

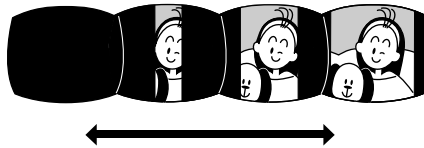

### Scroll (SCROLL)

When you start recording the picture appears from the right hand side of the screen and expands sideways until it fills the whole screen. When you end a scene, the image is wiped back off.

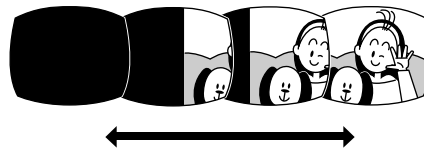

### Mosaic Fade (M. FADE)

Blurs the image by enlarging the size of some pixels. The image appears as increasingly large squares of color as it fades out, and smaller squares when it fades in.

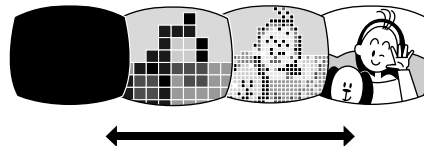

E

## ● Effects

### Art (ART)

Adds a paint-like effect, called solarization, to the image.

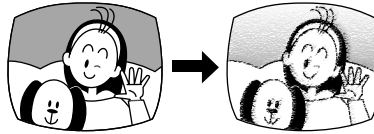

### Black and White (BLK & WHT)

Makes the image black and white.

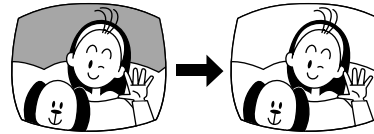

### Sepia (SEPIA)

Makes a monochrome image with a brownish tint.

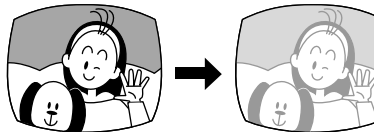

### Mosaic (MOSAIC)

Blurs the image by enlarging the size of some pixels.

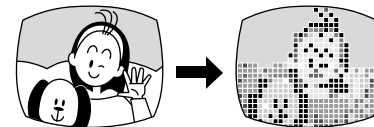

Using the Full  
Range of Features

Digital effects can be set with the controls on the body of the camera or the wireless controller. Pressing the ▲/▼ buttons on the wireless controller correspond to turning the SELECT dial up and down, and pressing the SET button corresponds to pressing the SELECT dial in.

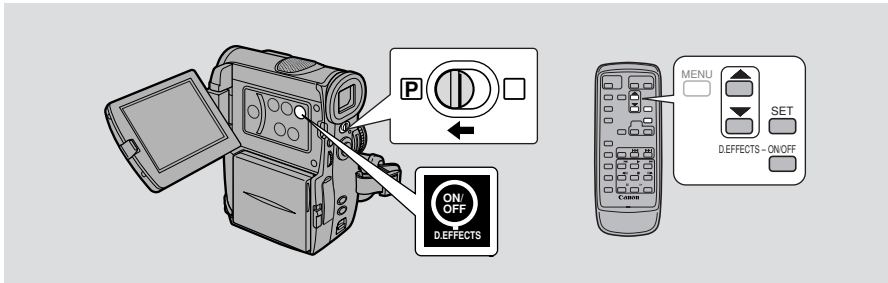

## Operating faders



Sound and image fade together.

When operating faders in MOVIE or P.SCAN mode, make sure the program selector is set to **P**.



**MENU**  
( 34)

► D. EFFECTS

► D. E. SELECT • FADER

► FADER • • • • • FADE-T

Select fader

1. **Open the menu and select D.EFFECTS.**
2. **Select D.E.SELECT.**
3. **Select FADER.**
  - You return to the D.EFFECTS submenu.
4. **Select FADER again (the name of the previously selected fader also appears).**
  - FADE-T, WIPE, SCROLL, M.FADE settings appear.
5. **Select the desired setting.**
  - The menu returns to the submenu.
6. **Close the menu.**
  - The name of your selected fader flashes in the display.

Fader on/off

7. **Press the D.EFFECTS ON/OFF button.**
  - The name of your selection stops flashing.
  - Each time you press the ON/OFF button, the chosen fader is activated (display lights continuously) or deactivated (display flashes).

E

**8. If you're in MOVIE or P.SCAN mode:****Fade in-** Press the start/stop button.**Fade out-** Press the start/stop button.**If you're in VCR mode:****Fade in-** Press the ► (play) button.**Fade out-** Press the || (pause) button.**Operating effects**

Sound records/plays back normally.

When operating effects in MOVIE, P.SCAN or CARD REC mode, make sure the program selector is set to P.



Select effect

**1. Open the menu and select D.EFFECTS.****2. Select D.E.SELECT.****3. Select EFFECT.**

- You return to the D.EFFECTS submenu.

**4. Select EFFECT again (the name of the previously selected effect also appears).**

- ART, BLK&WHT, SEPIA, MOSAIC settings appear.

**5. Select the desired setting.**

- The menu returns to the submenu.

**6. Close the menu.**

- The menu disappears and the name of your selected setting flashes in the display.

Effect on/off

**7. If you're in VCR mode, press the ► (play) button.****8. Press the D.EFFECTS ON/OFF button.**

- The name of your selection stops flashing and takes effect on the display.
- Each time you press the ON/OFF button, the chosen effect is activated or deactivated.

## Using the Multi-Image Screen

Divides your display image into 4, 9 or 16 smaller images with the Image Capture feature. With this feature, the camera captures the current scene being shot or replayed. Choose the transition speed — manual, fast (every 4 frames), moderate (every 6 frames) or slow (every 8 frames) — at which to capture a moving subject, such as a person playing tennis or golf. Sound is recorded normally.

E

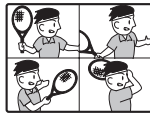

4 images



9 images



16 images

### Operating the multi-image screen



When operating the multi-image screen in MOVIE, P.SCAN or CARD REC mode, make sure the program selector is set to **P**.

In VCR mode, you can only operate the multi-image screen in the following playback modes:

When M.S.SPEED is set to MANUAL: Still picture playback, slow forward/reverse playback

When M.S.SPEED is set to FAST, MODERATE or SLOW: Still picture playback

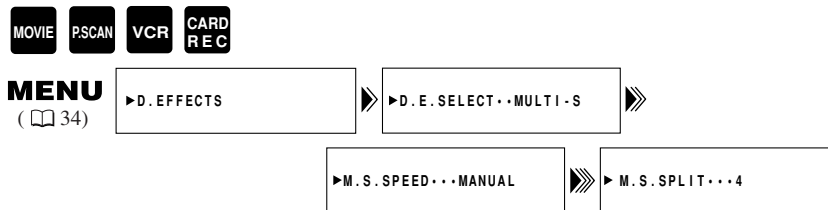

Select multi-image screen

1. **Open the menu and select D.EFFECTS.**
2. **Select D.E.SELECT.**
3. **Select MULTI-S.**
  - You return to the D.EFFECTS submenu.
4. **Select M.S. SPEED.**
  - MANUAL, FAST, MODERATE and SLOW settings appear.
5. **Select the desired setting.**
6. **Select M.S. SPLIT.**
  - 4, 9, 16 settings appear.
7. **Select the desired setting.**

Using the Full  
Range of Features

**E****8. Close the menu.**

- The digital effects menu disappears.
- MULTI-S flashes in the display.

Multi-image screen on/off

**9. Push the D.EFFECTS ON/OFF button.**

- Manual: As you press the ON/OFF button, scenes will be captured one after another the indicated number of times. If you push and hold the ON/OFF button for more than a second, the last image captured will be erased.
- The currently recording image is framed in blue. The frame disappears after the last image is captured.
- Automatic: The camera will capture the indicated number of images at the indicated speed.

**10. If you're in MOVIE or P.SCAN, push the start/stop button to begin recording.**

- The multi-image screen is recorded to the tape.
- ELURA2 MC only: If you're in CARD REC mode, push the PHOTO button to record the multi-image screen to the MultiMediaCard.



- You cannot use the multi-image screen with digital zoom or the 16:9 mode.
- You can operate the multi-image screen from record or record pause mode.
- After all the images have been captured, push the ON/OFF button quickly to cancel the multi-image screen.
- If you are operating the multi-image screen in VCR mode and you stop or pause the tape, or press any other playback button or the date/photo search buttons, the multi-image screen will be canceled. (This does not apply with the MANUAL multi-image speed.)
- You cannot use digital zoom when the multi-image screen is set. The display becomes “---”.



Using the Full  
Range of Features



## Audio Recording

### Selecting the audio mode



E

ELURA2/ELURA2 MC can record sound on a tape in two audio modes — 16 bit and 12 bit. The 16 bit mode produces the higher sound quality (slightly superior to CD) while the 12 bit mode records on two channels (stereo 1), leaving 2 channels free (stereo 2) for you to add new sound at a later date.



#### MENU

( 34)



To switch to the 16 bit mode, open the menu and select **VCR SET UP**. Then select **AUDIO MODE**, set it to **16 bit** and close the menu.

- “16 bit” is shown in the display for approximately 4 seconds.



- For details on adding new sound, see p. 88.
- For details of playing back a tape that has new sound on stereo 2, see p. 91.
- When you record to the ELURA2/ELURA2 MC from a camcorder with DV terminal outputs, the audio mode display becomes set to “— — —.”

### External microphone and headphones

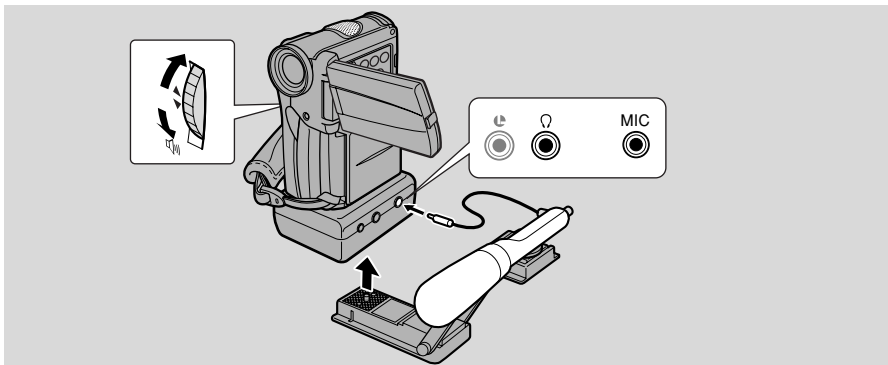

For greater creative control over audio recording, you can connect an external microphone to the camera via the DU-300 Docking Unit's MIC terminal. Attach the microphone to the optional SA-1 Adapter Bracket.

- 1. Attach the microphone to the adapter bracket.**
  - Extend the adapter bracket open until it locks.
- 2. Attach the adapter bracket to the docking unit.**
- 3. Connect the microphone.**

Using the Full  
Range of Features

**E**

You can monitor the sound while recording and playing back by attaching stereo headphones to the  terminal on the docking unit.

You can adjust the volume of attached headphones by turning the SELECT dial.

- A VOLUME bar appears in the display to indicate the current volume. The volume level is the same regardless of mode.
- The SELECT dial also controls the speaker volume once you remove the headphones from the headphone socket ( 65).
- The levels you adjust for the built-in speaker and headphones are memorized separately. The camera remembers your levels even if you turn the camera off and back on again.

### Wind screen



The camera has an automatic wind screen to prevent wind noise from interfering with the sound track of a tape. As a rule, use the wind screen when recording outdoors. Make sure it's off when recording indoors, where there is no wind to affect your recording.



#### MENU

( 34)

▶VCR SET UP

▶▶WIND SCREEN·ON

**To turn it off, open the menu and select VCR SET UP. Then select WIND SCREEN, set it to OFF and close the menu.**

- WS **OFF** is shown in the display when you turn the wind screen off.



- When the wind screen is on, some low sounds are cut out along with the sound of the wind.
- The wind screen can be used for audio dubbing with the built-in microphone as well as recording.
- The wind screen does not operate with an external microphone. The WIND SCREEN menu options disappear (“--”) when an external microphone is connected to the MIC terminal (on the DU-300). Note that WS **OFF** will not appear in the display when an external microphone is attached.

## Setting the Self-Timer

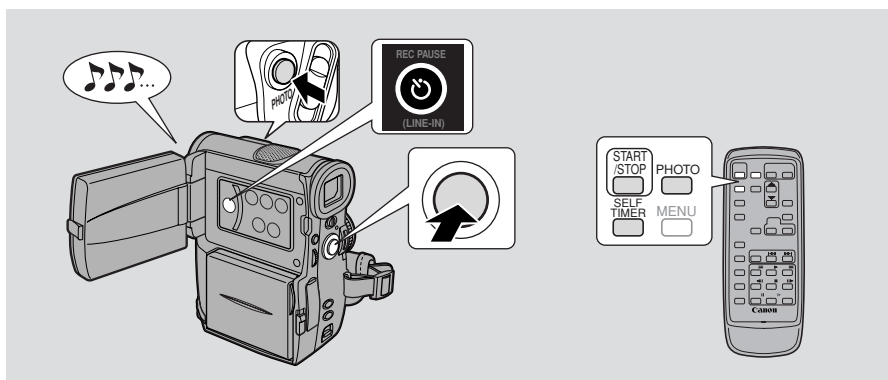

E

This is useful when you want to include yourself in the picture when recording movies or still photographs.



### 1. Press the self-timer button on the body of the camera

or

### the SELF TIMER button on the wireless controller.

- SELF-T appears in the display.
- To have the subject monitor recording, rotate the LCD panel 180° (  23).

For movies



### 2. Press the start/stop button.

- The camera starts to record after a 10-second countdown period (or after 2 seconds when you use the wireless controller). The time remaining counts down in the display (e.g. "5 SEC").
- SELF-T disappears from the display when recording begins.
- The tally lamp starts flashing.

### 3. Press the start/stop button to end recording.

For stills



### 2. Press a PHOTO button on the camera body or the wireless controller.

- The camera automatically adjusts the focus 2 seconds before the countdown is complete. The  mark flashes white then turns green after the focus and exposure are set. If you are using the wireless controller, the  mark starts flashing immediately after you press the PHOTO button.
- The camcorder takes the picture for approximately 6 seconds.

Using the Full  
Range of Features

**E**



- If you have the beep turned on, it sounds each time the tally lamp flashes before recording.
- To cancel the self-timer before the countdown has begun, press the  SELF TIMER button.
- To cancel the self-timer once the countdown has begun, press the  SELF TIMER button, start/stop if you're shooting movies, or PHOTO if you're taking a still image.

## Adjusting Exposure Manually

### Exposure lock



When you are recording in situations where the lighting may change suddenly, you can lock the exposure at the current level in order to control the brightness of the image.

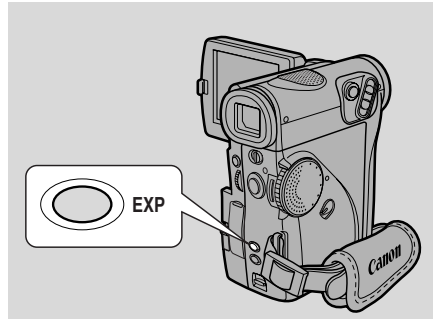

To lock the exposure, press the EXP button. Press it again to return to auto exposure.

### Exposure adjustment



When the exposure is locked, you can adjust it manually, making the picture brighter or darker in order to deal with difficult lighting conditions. The camera's iris can be manually set to any position from fully closed to fully open.

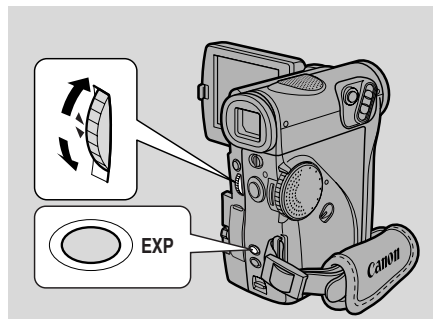

To make the recorded image brighter, turn the SELECT dial upwards (to a maximum of +11). This may be necessary if the background is very bright, or if the subject is lit from behind.

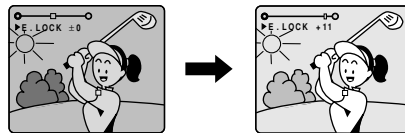

To make the recorded image darker, turn the SELECT dial downwards (to a minimum of -11). This may be necessary if the background is very dark, or if the subject is spotlighted.

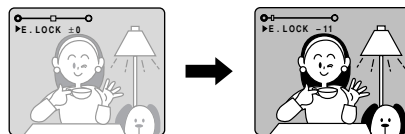

Using the Full  
Range of Features

**E**

- You cannot adjust the exposure without the ► mark before E.LOCK in the display. Push the EXP button so that ► appears before E.LOCK. Then you can adjust the exposure manually.
- The standard exposure level depends on which recording program you have selected.
- Exposure lock is canceled if you change recording programs.
- You cannot use exposure lock or adjustment when the program selector is set to the □ (Easy Recording) position.
- If you zoom while the exposure is locked, the brightness of the scene may change.

## Shutter speed



Set the shutter speed manually to take stable shots of quickly moving subjects.



### MENU

( 34)

►CAM.SET UP

►►SHUTTER.....AUTO

Using the Full  
Range of Features

1. Make sure the camera is set to the (program AE) mode.
2. Open the menu and select CAM.SET UP.
3. Select SHUTTER.
4. Press the SELECT dial in to select the desired shutter speed.

AUTO		
1/60	↑	slower
1/100		
1/250		
1/500		
1/1000		
1/2000	↓	faster

5. Close the menu.

- The camera returns to the auto shutter setting when you slide the program selector to □ (Easy Recording), or change the recording program.

### Concerning shooting in fluorescent lighting

When the camera is set to  (Easy Recording) or the Auto recording program, it automatically detects the flicker of fluorescent lighting and adjusts the shutter speed to compensate. However, if the brightness of the LCD or viewfinder display starts to flicker, make sure the camera is set to the Auto recording program and select the 1/100 shutter speed.

### Guidelines for shooting using high shutter speeds

- When shooting with a shutter speed of 1/1000 or higher, do not shoot the sun directly.

### Recommended shutter speeds when shooting:

- People doing outdoor sports such as golf or tennis



1/2000

- Moving cars or trains or other rapidly moving vehicles such as roller coasters

1/1000, 1/500 or  
1/250

- People doing indoor sports such as basketball



1/100



- You are unable to set the shutter speed when exposure lock is set in any recording program other than AUTO. The SHUTTER display becomes set to “\_ \_ \_ .”
- The image may not appear smooth when a high shutter speed is set.

## Adjusting Focus Manually

E

The camera can focus automatically. All you have to do is point it, and whatever is in the center of the display will usually be in sharp focus. If it does not seem to be focusing well, it may be because the subject is not suitable for autofocus.

You can use the manual focusing function for more control over focusing.

### Focus lock



Press the FOCUS button to turn off autofocus. The focus remains locked at the point set by autofocus.

(▶M.FOCUS appears in the display.)

You can now adjust the focus manually with the SELECT dial. Press the FOCUS button again when you want to return to autofocus.

- If you zoom in on your subject after turning off autofocus, it may not stay in focus. It is generally best to adjust the zoom first, and then the focus.

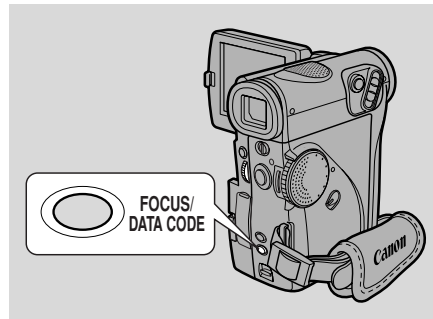

### Manual focus



Use the SELECT dial to set the focus.

- Turn the SELECT dial downward to move the focus farther away.
- Turn the SELECT dial upwards to bring the focus nearer.

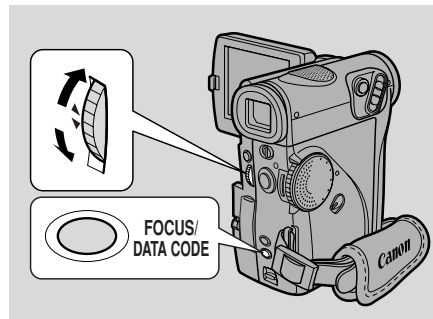

Using the Full  
Range of Features



- You cannot adjust the focus without the ▶ mark before M.FOCUS in the display. Push the FOCUS button so that ▶ appears before M.FOCUS. Then you can adjust the focus manually.
- The manual focus setting is canceled if you select the  (Easy Recording) program.
- When you are using the  (Easy Recording) program, autofocus cannot be turned off.
- See “Troubleshooting” on p. 124 for a list of subjects which may not be suitable for autofocus.



## Setting the White Balance



The camera's auto white balance system compensates for a wide range of lighting conditions. Although slight variations are unavoidable, colors will appear natural in virtually every situation.

In some cases, you will get better results by setting the white balance yourself, or using one of the two preset modes:

- ☑ Indoor Mode
  - Under halogen or studio/video lighting
  - Subject is of one dominant color
  - Close ups
- ☀ Outdoor mode
  - In daylight, especially for close-ups and where the subject is of one dominant color

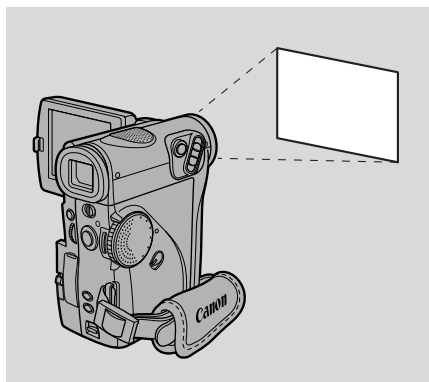



E



**MENU**  
( 34 )

▶ CAM.SET UP

▶ WHITE BAL...AUTO

1. Make sure the camera is set to the **P** (program AE) mode.
2. Open the menu and select CAM.SET UP.
3. Select WHITE BAL.
4. a) For the indoor, outdoor or auto settings, press the SELECT dial in to choose the setting.
  - ☑/☀ appears in the display when you set the white balance to indoor/outdoor mode.
- b) To set the white balance yourself, point the camera at a white object (such as a sheet of paper) and zoom in until it fills the display. Then press the SELECT dial in to select SET .
- Select SET  again.
  - Make sure to continue pointing the camera at the white object until you have finished setting the white balance.
  - The  display flashes then remains lit.
  - Depending on the light source, the flashing may at times continue. The result will remain better than with the auto setting and you can continue recording.
5. Close the menu.

Using the Full  
Range of Features

**E**

Setting the white balance manually will probably work better than auto white balance when shooting:

Subjects with one dominant color, such as sky, sea or forest



Close-ups



In rapidly changing lighting conditions



In places lit by certain types of fluorescent or mercury vapor lights



- Turn the digital zoom off (if necessary) to set a more accurate white balance.
- If you have set the white balance and lighting conditions change, reset the white balance.
- Try to record with light from a single source. Correct white balance cannot be obtained for two types of lighting at once.
- You cannot set the white balance or choose the indoor/outdoor mode when the program selector is set to the  (Easy Recording) program.
- The white balance returns to the AUTO setting when you slide the program selector to  (Easy Recording).
- When you turn the camera on, the white balance returns to AUTO. If you then switch the white balance to SET, the camera will remember your last setting.
- During normal outdoor shooting, setting to AUTO may provide better results.

Using the Full  
Range of Features

## Displaying Date, Time and Camera Data (Data Code)

The data code contains the date and time the recording was made. Cassette data codes can also display camera data (shutter speed and exposure settings).

E

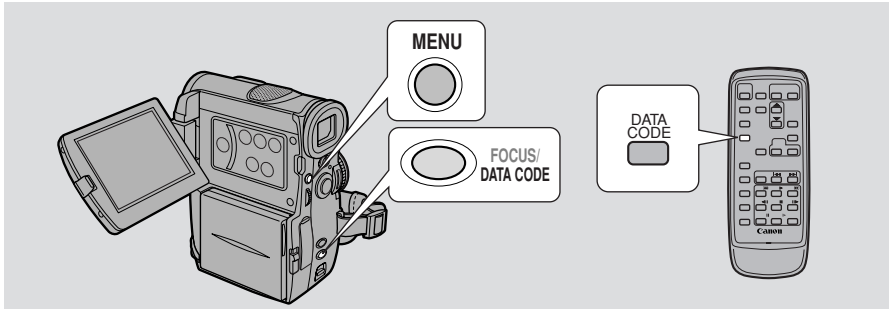

During VCR mode, the data code can be displayed or hidden while the camera is in play, slow or still mode.

Camera data may be displayed as “--” during fast forward, rewind, reverse playback, forward and reverse  $\times 2$  playback.

**Press the DATA CODE button while the camera is in play, slow or still mode.**

- Press it once to display, once more to hide it.

### Selecting date/time



Select whether you want the date, the time, or both to show up on your data code display ( 76).



**MENU**  
( 34)



**To change the date and time combination, open the menu and select DISP.SET UP. Then select D/TIME SEL., set it to DATE, TIME or DATE & TIME and close the menu.**

Using the Full  
Range of Features

E

## Setting the data code



You can also choose to display camera data (shutter speed and exposure settings) in cassette data codes.



### MENU

( 34)

▶ DISP.SET UP

▶▶ DATA CODE...DATE/TIME

To change, open the menu and select **DISP.SET UP**. Then select **DATA CODE**, set it to **DATE/TIME**, **CAMERA DATA** or **CAM. & D/T** and close the menu.

Possible data code combinations:

DATA CODE (cassette only) D/TIME SEL.	Date/Time	Camera data	Date/Time & Camera data
Date	JAN. 1, 2000	F32 1/2000	F32 1/2000 JAN. 1, 2000
Time	12:00:00 AM	F32 1/2000	F32 1/2000 12:00:00 AM
Date & Time	12:00 AM JAN. 1, 2000	F32 1/2000	F32 1/2000 12:00 AM JAN. 1, 2000



- The data code will read “- -” in the following situations:
  - During playback of a blank section of tape.
  - If the tape was recorded before entering the date and time in the camera’s memory.
  - If the tape was recorded on a camera without a data code function.
  - If noise or tape damage prevents the data code from being read.
- If a recording made on ELURA2/ELURA2 MC is played back on a different DV camcorder, the data code may not be displayed correctly.
- The data code will appear in the display even if DISPLAYS ( 132) has been set to OFF through the menu.

Using the Full  
Range of Features

## Six-second auto date



E

The 6-second auto date appears for 6 seconds to mark the changeover of a day if the tape was being recorded at 12:00 midnight. It also appears for 6 seconds when you start playback and have the data code turned off. The 6-second auto date will adjust for any time zone changes you have indicated.



### MENU

( 34)

▶ DISP.SET UP

▶▶ 6SEC. DATE...OFF

**To turn the 6-second auto date on, open the menu and select DISP.SET UP. Then select 6SEC. DATE, set it to ON and close the menu.**



- When 6SEC.DATE is turned on but DISPLAYS ( 132) is turned off, the 6-second auto date will still appear for 6 seconds.

Using the Full  
Range of Features

## Searching the Tape (Photo Search/Date Search)

E

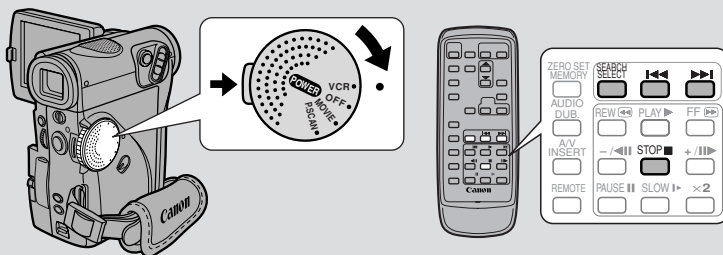

This allows you to move quickly through still pictures recorded anywhere on a tape (photo search) or between different days or areas of recording (date search) on a tape.

VCR

### 1. Press the **SEARCH SELECT** button to choose between photo/date search.

- PHOTO SEARCH or DATE SEARCH is shown in the display for 4 seconds.

### 2. Press the **◀◀** and **▶▶** buttons to move backwards or forwards through the still pictures or between different days of recording.

- Press once to move to the start of the previous/next still picture or day on the tape.
- You can press more than once to move to the corresponding still picture or day (up to a maximum of 10 times), e.g. press the **▶▶** button 5 times to move forward 5 still pictures or days.
- PHOTO SEARCH/DATE SEARCH appears in the middle of the display alongside the **◀◀** or **▶▶** mark and number to search through. The recording mode is also shown (SP/LP).



- Press **■** (stop) to stop mid-search.
- If you begin a search very close to the start of a recorded still picture during photo search, the camera may skip straight past it.
- When you have set the area for the World Clock, date search also looks for the change in date based on the adjusted time.
- A date/area cannot be identified if the total recording time on that day/area was less than 1 minute.
- Date search playback may start just before or after the beginning of the located section.
- If the data code is not displayed correctly you will not be able to operate the date search correctly.

Using the Full Range of Features

## Returning to a Pre-Marked Position



E

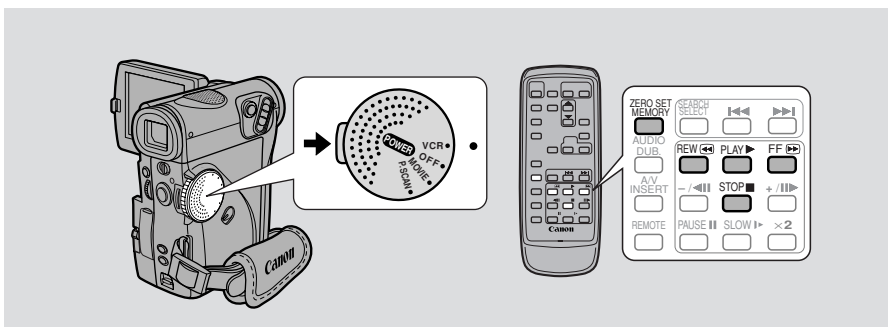

Use the wireless controller to mark a point on a tape that you want to return to following playback.



### 1. Press the ZERO SET MEMORY button on the wireless controller during playback at a point you want to return to later.

- The time code is replaced by a tape counter that is set to zero with the **M** indication.
- Press the ZERO SET MEMORY button once more to cancel the zero set memory.

### 2. When you have finished playback, fast forward or rewind the tape. The tape stops automatically when it reaches the zero set position.

- **RTN▶▶** or **◀◀RTN** appears in the display.
- The tape counter with **M** indication disappears from the display and the time code reappears.



- The zero set memory may not function correctly where there is a break between recordings on the tape.
- You can also use zero set memory to mark a position on a tape in camera mode. When you then play back the tape, pressing rewind will take you back to the pre-marked position.
- If you remove the tape while the zero set memory is set, the memory is canceled and the tape counter reverts to time code.
- The camera remembers your setting even if you turn it off and back on again or move the program selector.

Using the Full  
Range of Features

## Editing to a VCR

**E**

By connecting the camera to a VCR, you can edit your recordings in order to remove unwanted scenes — or combine different shots to create your own video productions.

### Preparations

- 1. Connect the camera to the VCR.**
  - See “Connections for Playback on a TV Screen” on p. 28.
- 2. Prepare the TV and VCR.**
  - Turn on the TV and set the TV/VIDEO selector to VIDEO.
  - Turn on the VCR, and set its input selector to LINE. Load a blank cassette, and put the VCR in record pause mode.
  - See your TV and VCR instruction manuals for details.
- 3. Turn the camera’s POWER dial to VCR, and load your recorded cassette.**

### Editing



- 1. Find a point on your recorded cassette slightly before the section you want to copy.**
- 2. Start to play it back while you monitor the picture on the TV.**
- 3. Start recording on the VCR as soon as the section you want to copy appears on the screen.**
- 4. Pause the VCR at the end of the section you want to copy, then stop playback on the camera.**
- 5. Repeat steps 1 to 4 until your edited recording is complete.**





- The quality of the edited tape will be slightly lower than that of the original.

### LANC terminal

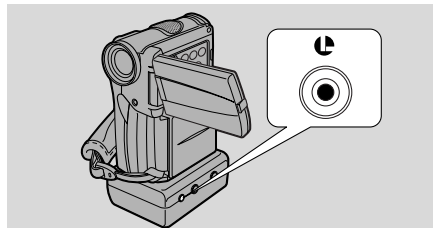
The  terminal allows you to connect the camera to equipment. Some buttons on editing equipment may operate differently from those on the camera.



-  (LANC) is a trademark. It stands for Local Application Control Bus System.
- We cannot guarantee the results when connecting to equipment not bearing the LANC  symbol.



## Dubbing to/from a Cassette with Digital Video Equipment

Digital video equipment fitted with the DV terminal lets you edit, copy and transfer data digitally, with virtually no generation loss in image and sound quality. The DV terminal is for both line-in and line-out, since a single DV cable can handle data in both directions.

- If a digital VCR is connected and an anomalous signal is sent from the VCR, the images recorded on the tape may also be anomalous (although it may not appear so on the TV image), or not recorded at all.
- You are unable to dub tapes recorded with the copyright protective signal.

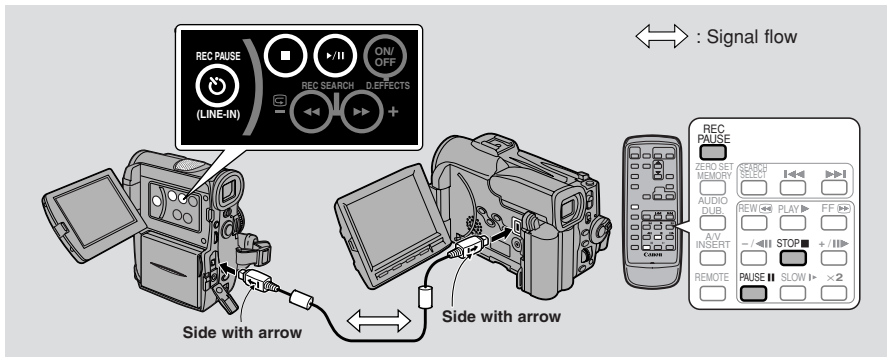

### Preparations

#### Example dubbing to the camera

- 1. Connect the camera and the other digital device.**
  - Connect the Canon CV-150F DV cable (optional) with the sides of the plugs marked with the arrows facing as shown above.
- 2. Prepare the other device.**
  - Turn on the power and load a recorded cassette.
- 3. Turn the camera's POWER dial to VCR and load a blank cassette.**
  - DV IN appears in the display.

## E

**Dubbing**

1. **Find a point on your recorded cassette slightly before the section you want to copy and set it to playback pause mode.**
2. **Press the camera's REC PAUSE button.**
  - The camera enters record pause mode.
3. **Start playback on the other digital device while you monitor the picture.**
4. **Press the pause button.**
  - Recording starts.
5. **When you get to the point where you want to stop recording, press the stop button or the pause button.**
  - Recording stops.
6. **Stop playback on the other device.**



- If the cable is not connected properly, or if the cable is unconnected when you press REC PAUSE, the camera displays the caution "CHECK THE DV INPUT." An anomalous image may also flash onto the screen.
- Blanks between recordings on the playback tape are recorded as anomalous images on the tape that is being recorded to.
- During DV dubbing you cannot add digital effects.

**Copyright signal**

Certain pre-recorded software tapes are copyright protected. If you try to play back such a cassette, "COPYRIGHT PROTECTED PLAYBACK IS RESTRICTED" appears in the display for a few seconds and then the camera displays a blank blue screen; you cannot view the contents of the cassette. If you try to record from such a tape via the digital cable "COPYRIGHT PROTECTED DUBBING RESTRICTED" appears in the display; you cannot record the contents of the tape.

## Recording from a VCR, TV or Analog Camcorder (Analog Line-in)

You can record a TV program or a video played on your VCR or analog camcorder (for digital camcorders, see p. 81) onto a tape in the ELURA2/ELURA2 MC, if the TV or other device has audio/video outputs.

- If an anomalous signal is sent from the TV or VCR, the images recorded on the tape may also be anomalous (although it may not appear so on the TV image), or not recorded at all.
- You are unable to dub tapes recorded with the copyright protective signal.

E

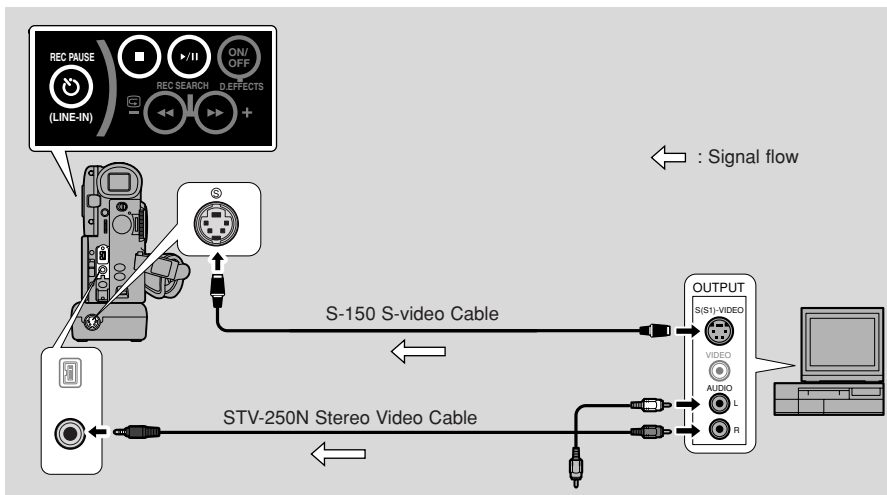

Attach the DU-300 Docking Unit in order to use the S-video terminal ( 28).

### Preparations

- 1. Connect the camera to the VCR, TV or other camcorder.**
- 2. Prepare the device.**
  - Set the TV/Video selector on the television to Video. For further details, see “Connections for Playback on a TV Screen” on p. 28.
  - Turn on the VCR. Load your recorded cassette, and put the VCR in playback pause mode.
  - See your TV and VCR instruction manuals for details.
- 3. Turn the camera’s POWER dial to VCR, and load a blank cassette.**

Editing

## E

**Dubbing**

- 1. Find a point on your recorded cassette slightly before the section you want to copy and set it to playback pause mode.**
- 2. Press the REC PAUSE button.**
  - S-video and A/V IN/OUT terminals automatically work as input terminals.
  - The camera enters record pause mode.
- 3. Start playback on the other device or turn on the TV to see the desired program while you monitor the picture.**
- 4. Press the pause button.**
  - Recording starts.
- 5. When you get to the point where you want to stop recording, press the stop button or the pause button.**
  - Recording stops.
- 6. Stop playback on the other device.**



- You can monitor the picture in the viewfinder or LCD.

  
Editing

## Recording Over Existing Scenes (A/V Insert Editing)

You can insert new scenes from your VCR or other camcorder onto your pre-recorded tape using the ELURA2/ELURA2 MC's analog line-in or DV in terminals. Original video and audio will be replaced with the new video and audio.

E

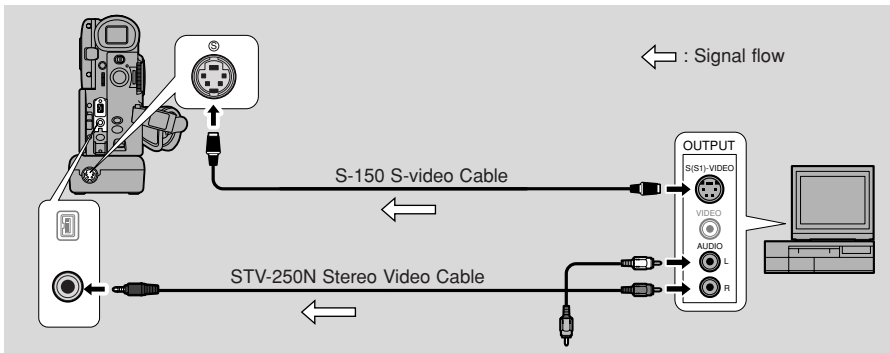
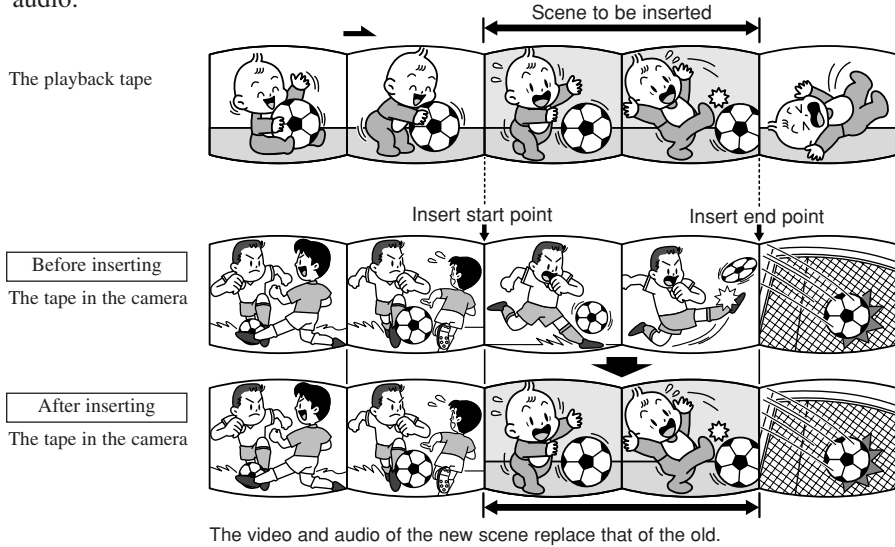

Editing

Attach the DU-300 Docking Unit in order to use the S-video terminal ( 28).

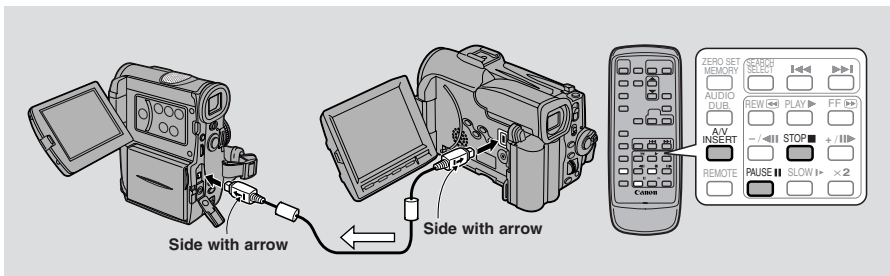

**E****Preparations****The tape in the camera:**

When using the ELURA2/ELURA2 MC's A/V insert function, only record to tapes recorded in SP mode with continuously recorded time codes. If there are non-recorded portions or portions recorded in LP mode on the tape, recording will stop.

**The playback tape:**

Use only tapes without non-recorded portions. If there are non-recorded portions or changes in the recording mode, you may not be able to insert A/V correctly.

You cannot insert A/V in the following cases:

- The playback tape has been poorly recorded.
- During special playback: fast forward playback, rewind playback or slow playback etc. (analog only).

**TV:**

You cannot insert A/V from a TV program with anomalous synchronized signals, such as when the program itself received poor signals.

**Example recording from a VCR****Editing**

- 1. Connect the camera to the VCR.**
- 2. Prepare the VCR and TV.**
  - Set the TV/Video selector on the television to Video. For further details, see "Connections for Playback on a TV Screen" on p. 28.
  - Turn on the VCR and load a recorded cassette.
  - See your TV and VCR instruction manuals for details.
- 3. Turn the camera's POWER dial to VCR and load a recorded cassette.**
  - Make sure the REC/SAVE tab on the cassette has been slid to REC (closed position).

## Editing



E

1. **On the VCR, locate a point 3 seconds before the scene to be inserted. Set the VCR to playback pause mode.**
2. **On the camera, press PLAY and locate the recording start point. Set the camera to playback pause mode.**
  - You can use the playback buttons on the body of the camera or the special playback functions on the wireless controller in the same way as in playback mode.
3. **Press the A/V INSERT button.**
  - A/V INSERT and ●■■ appear in the display.
4. **Play back the cassette in the VCR.**
5. **To start inserting, press the PAUSE button on the camera.**
  - ●■■ changes to ●.
6. **To stop inserting, press the STOP button on the camera.**
  - Inserting stops and A/V INSERT disappears from the display. The camera returns to stop mode.
  - If instead of pressing STOP you press PAUSE, the camera returns to the A/V insert pause mode.
  - If you set the zero set memory at the position on the tape where you want to stop inserting, every time you return to that point, the camera will cancel its A/V inserting and enter stop mode.
7. **Stop playback on the VCR.**

Editing

## Audio Dubbing

E

You can add sound to the original sound on a prerecorded tape from audio products (AUDIO IN) or with the internal or external microphone (MIC. IN). The original sound will not be erased. For best results, add sound to tapes that have been recorded with this camera in SP mode with 12 bit sound. If there are non-recorded portions on the tape, or portions recorded in LP mode, or with 16 bit or 12 bit, 4-channel sound, dubbing will stop. If your tape hasn't been recorded in SP mode with 12 bit sound, we recommend dubbing your original tape onto a blank tape using the ELURA2/ELURA2 MC's analog line-in function, then dubbing audio onto the new tape. Make absolutely sure to set the audio mode of the new tape to 12 bit and the recording mode to SP.

### To connect other audio equipment:

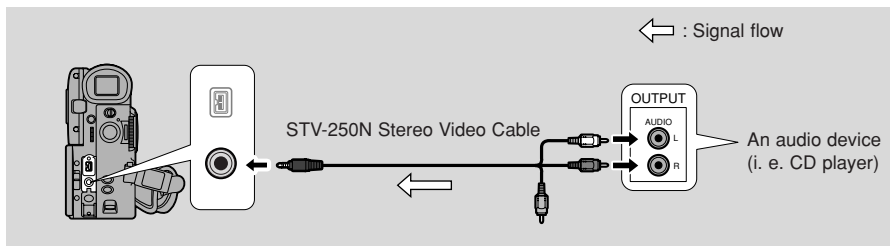



- Do not use the yellow video terminal.
- The A/V terminal doesn't put out any video, so connect the S-video terminals and check your TV, or check the LCD or the viewfinder as you add new sound. Always check the new sound with the speaker or the headphones.

Editing

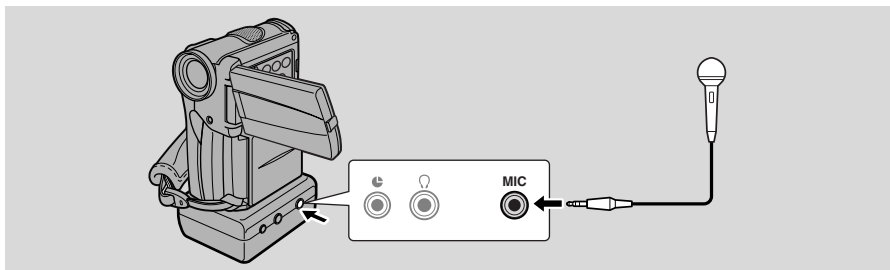
### To connect an external microphone:



Connect the DU-300 Docking Unit (  28) and the optional SA-1 Adapter Bracket (  65) in order to use an external microphone.





- When you add sound using the built-in microphone make sure not to connect any cables to the MIC terminal (on the DU-300).
- To use your TV to monitor video, connect the S-video terminal ( 29) or the A/V terminal (use only the video plug) to your TV. You can monitor the sound with headphones ( 65).

E

## Preparations

Turn the camera's POWER dial to VCR and load a recorded cassette.

- Make sure the REC/SAVE tab on the cassette has been slid to REC (closed position).

## Dubbing

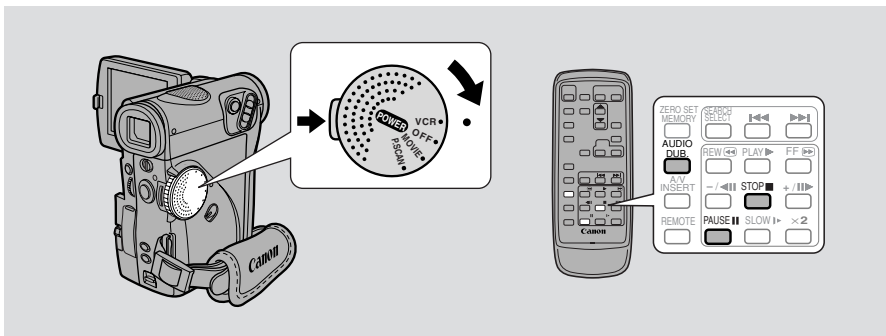

Do not connect/disconnect any cables to/from the camera when dubbing audio or preparing to dub audio.



## MENU

( 38)

▶ VCR SET UP

▶ AUDIO DUB...AUDIO IN

1. Open the menu, select **AUDIO DUB**.
2. Select **AUDIO IN** or **MIC. IN** and close the menu.
3. Locate the point where you want to start audio dubbing, then press the **PAUSE** button.
  - You can use the playback buttons on the body of the camera or the special playback functions on the wireless controller in the same way as in playback mode.
  - The camera becomes set to playback pause mode.



Editing

89

**E****4. Press AUDIO DUB.**

- AUDIO DUB. and  appear on the display.

**5. Press the PAUSE button (and start play on the other audio device if AUDIO IN).**

- Audio dubbing starts.
- If MIC. IN, direct your voice into the microphone.
-  changes to .

**6. When you get to the point where you want to stop dubbing, press the STOP button (and then stop play on the other audio device if AUDIO IN).**

- Audio dubbing stops and AUDIO DUB. disappears from the display.
- The camera returns to stop mode.
- You can also set zero set memory ( 79) at the place you want to stop audio dubbing, then every time you return to that position, audio dubbing will cancel.
- If instead of pressing STOP you press PAUSE, the camera will return to the playback pause mode.



- You can not use the DV terminal while adding sound.
- You might want to adjust the audio mix ( 91) when playing back a tape with added sound.
- There may be a loss of sound quality if you add sound to a tape recorded on a camcorder other than the ELURA2/ELURA2 MC.
- After adding sound 3 or more times to the same place on a tape, there may be some loss in sound quality.

**Editing**

## Setting the Audio Mix

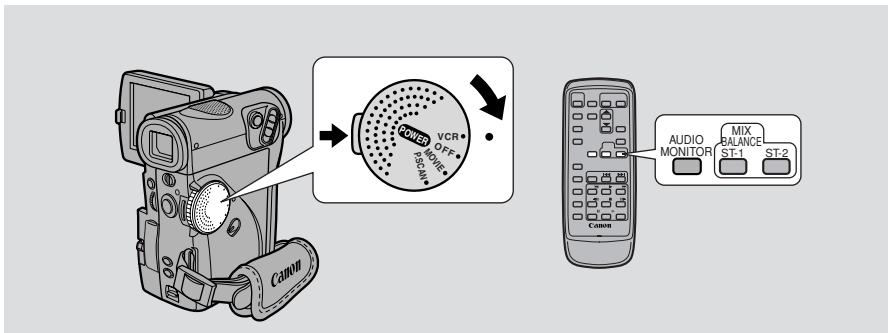

E

When you play back a tape that was recorded in 12 bit mode, you can set the audio output to play: stereo 1 (the original sound), stereo 2 (any new sound, dubbed to the tape after recording), or mix the balance between the two.

- Audio from the 16 bit mode only contains stereo 1 sound and so you cannot/do not need to select the audio mix. The same is true for the 12 bit stereo 1 mode, unless new sound has been added post-recording.



### Choose the output.

- Press **AUDIO MONITOR** on the wireless controller.
- Starting with the last selected setting, 4 settings appear as you push the button:
  - STEREO1 for just stereo 1.
  - STEREO2 for just stereo 2.
  - MIX/FIXED for an equal mix of stereo 1 and 2.
  - MIX/VARI. (mix variable) for when you want to mix the balance between stereo 1 and 2.
- To simply choose STEREO1, STEREO2 or MIX/FIXED, make sure your choice appears on the display.
- If you choose MIX/VARI., you can go on to mix the balance.
- Use the ST-1/ST-2 keys to mix the balance. A bar showing the mix appears on the screen for 4 seconds.



- When you have chosen the output, STEREO1, STEREO2, MIX/FIXED or MIX/VARI. is shown in the top left of the display for a few seconds. If you turn the power off the output is set to STEREO1.



Editing

E

## Selecting audio output channels



When you play back a tape whose audio has been recorded on multiple channels, you can change the output channels of that sound.

VCR

**MENU**

( 34)

▶VCR SET UP

▶▶OUTPUT CH...L/R

1. Load a tape recorded with multiple-channel audio.
2. Open the menu and select VCR SET UP. Then select OUTPUT CH, set it to the desired setting and close the menu.
  - Refer to the following list.

OUTPUT CH setting	Played back sound	
	Tape recorded with stereo sound	Tape recorded on multiple channels
L/R	L+R channels	main + sub
L/L	L channel only	main only
R/R	R channel only	sub only

Editing

## MultiMediaCard Introduction -ELURA2 MC only-



The MultiMediaCard (MMC), a type of Memory Card, stores and manages still images taken by the camera.

E

### You can do the following with the MultiMediaCard:

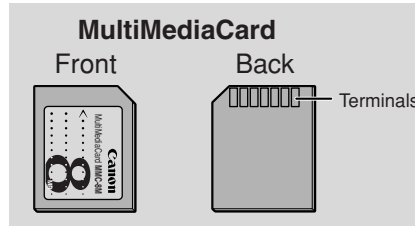
- Record still images ( 97)
- View still images 3 ways: Single ( 101), Slide show ( 102), Index ( 102)
- Select the quality of images recorded on the card ( 94)
- Protect important images against accidental erasure ( 103)
- Erase ( 104) and print mark ( 111) still images
- Create interesting effects by combining images ( 106)
- Record a still image from a cassette ( 99)
- Copy multiple still images automatically to and from a cassette ( 109, 110)



You can use most of the camera's functions when recording to a MultiMediaCard, such as the various recording programs ( 53), self-timer ( 67), shutter speed ( 70), white balance ( 73) and other manual adjustments. Available functions are marked with a  or  icon.

- While the camera is recording the still image, >>>> appears red in the display. (It appears white when in mirror mode and on the screen of a connected TV.)
  - While >>>> appears red in the display, do not remove the MultiMediaCard or disconnect the power source. Doing so could result in data damage.
- While the camera is retrieving a still image, <<<< appears green in the display.
  - While <<<< appears green in the display, do not remove the MultiMediaCard. Doing so could result in data damage.

### Important

- Inserting or removing the MultiMediaCard without first setting the POWER dial to OFF can result in data damage.
- This camera uses only MultiMediaCards. You cannot use any other types of Memory Cards.

Using the MultiMediaCard  
(ELURA2 MC only)

**E**

**Inserting and removing the MultiMediaCard**

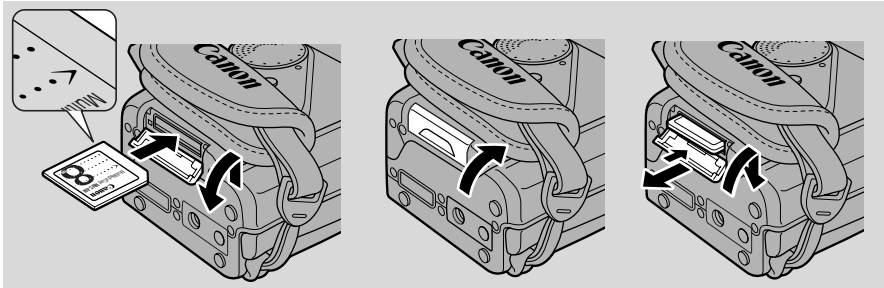

1. Turn the **POWER** dial to **OFF**.
2. Slide the MultiMediaCard compartment cover in the direction of the arrow and open.
3. Insert or remove the MultiMediaCard.
  - Push the MultiMediaCard all the way in.
  - Remove the MultiMediaCard by pushing the card in and letting it spring out.

Do not attempt to pull the MultiMediaCard out without first pushing it in.

4. Close the cover.



- When you set the **POWER** dial to **CARD PLAY**, the last image recorded appears. If there are no images recorded on the MultiMediaCard, **NO IMAGES** appears in the display.
- Do not touch the MultiMediaCard terminals.

**Selecting the recording image quality**



Select the quality of a still image to be recorded.



**MENU**

( 34 )



Make sure the **POWER** dial lock lever is switched to the **●●** position. Open the menu and select **CARD SET UP**. Then select **QUALITY**, set it to **STANDARD** and close the menu.

Using the MultiMediaCard (ELURA2 MC only)



- Depending on the image you are recording, sometimes there will be no difference in image quality between settings.
- Images are compressed and recorded in the JPEG (Joint Photographic Experts Group) format.
- The number of pixels is  $640 \times 480$  (VGA) in both FINE and STANDARD modes.

E

Image quality	Necessary memory per image	Number of images per 8MB MMC*	Use when you want to...
FINE	Approx. 124 KB	Approx. 60 images	...save high quality images, print out, etc.
STANDARD	Approx. 70 KB	Approx. 105 images	...attach images to Emails, include them in your own home page, etc.

- \* These figures are approximate. The actual number you will be able to record varies depending on the images. Remember that the sample images already recorded on the supplied MultiMediaCard are included in the total number.
- The number of images that can still be recorded on a MultiMediaCard may sometimes decrease by 2 images at once.
  - Refer to p. 135 for the MultiMediaCard displays.



Using the MultiMediaCard  
(ELURA2 MC only)

**E**

**File numbers**



The images you take are automatically assigned file numbers from 0001-9900 and stored in folders of 100 images each. Each folder is numbered from 100 to 998 and recorded on the MultiMediaCard. Sample images have been pre-recorded on the supplied MultiMediaCard, entering folder number 100.

Set the image file numbers so that they reset each time a new MultiMediaCard is inserted, or so that they count up continuously.

**1 CONTINUOUS**

Numbering is continuous between cards, so that the first file number assigned on a new MultiMediaCard is 1 more than the last file number assigned on the previous MultiMediaCard. When the file numbers are set to CONTINUOUS, each image taken is assigned a different number, avoiding duplication of numbers. This is convenient when you want to manage your images on a PC. We recommend keeping the file numbers set to CONTINUOUS.

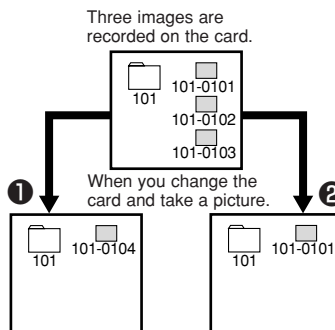

**2 RESET**

Each time you insert a new MultiMediaCard, the file number resets to its default value (101-0101). If the card already contains files, the next available number is assigned.



**MENU**

( 34)



To change the file numbering, open the menu and select **CARD SET UP**. Then select **FILE NOS.**, set it to **RESET** and close the menu.

**Turning the shutter sound off**



Makes the sound of a shutter being released when a still image is recorded to a MultiMediaCard.



**MENU**

( 34)



To turn the shutter sound off, open the menu and select **CARD SET UP**. Then select **SHTR SOUND**, set it to **OFF** and close the menu.

Using the MultiMediaCard (ELURA2 MC only)



## Recording Still Images to a MultiMediaCard



-ELURA2 MC only-

E

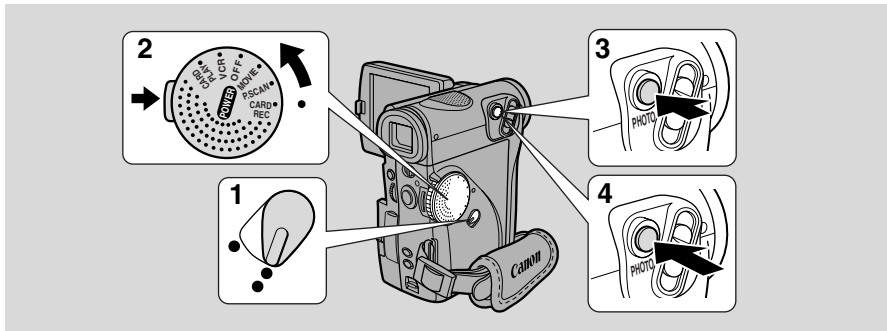

Take still images to a MultiMediaCard. You can also record onto a MultiMediaCard images from a tape in the camera, or images input through the DV in terminal.

- Moving pictures cannot be recorded onto a MultiMediaCard.
- Images input through the A/V in terminal cannot be recorded onto a MultiMediaCard.
- MultiMediaCards cannot record audio.

Make sure a MultiMediaCard that has enough memory available is inserted into the camera.

- 1. Set the POWER dial lock lever to the ●● position.**
- 2. Press the button next to the POWER dial and hold, turn the POWER dial to CARD REC.**
  - The number of images that can still be recorded on the MultiMediaCard appears in the display.
  - The camera will turn itself off if you are using a battery and do not operate the camera for more than about 5 minutes. Set the POWER dial to OFF and then back to CARD REC.
- 3. Press the PHOTO button halfway and hold it.**
  - Exposure is locked.
  - During autofocus ● flashes white in the display as the camcorder adjust the focus and it is displayed continuously as a green mark when the camera is ready to take the still image.
- 4. Press the PHOTO button fully down to record the still picture.**
  - ● disappears from the display.
  - The shutter sound ( 96) sounds if you have it turned on.
  - The image appears in the display and is recorded to the MultiMediaCard.
  - While the camera is recording the still image, >>>> appears red in the display. (It appears white when in mirror mode and on the screen of a connected TV.)

Using the MultiMediaCard  
(ELURA2 MC only)

**E**

- To use the self-timer, press the  button before step 3, and then press the PHOTO button fully down. For full details of how to use the self-timer, refer to p. 67.
- The wireless controller's PHOTO button has no half-way setting. Press the button fully and the camera immediately takes the image.



Using the MultiMediaCard  
(ELURA2 MC only)

## Recording an Image from a Cassette as a Still Image



-ELURA2 MC only-

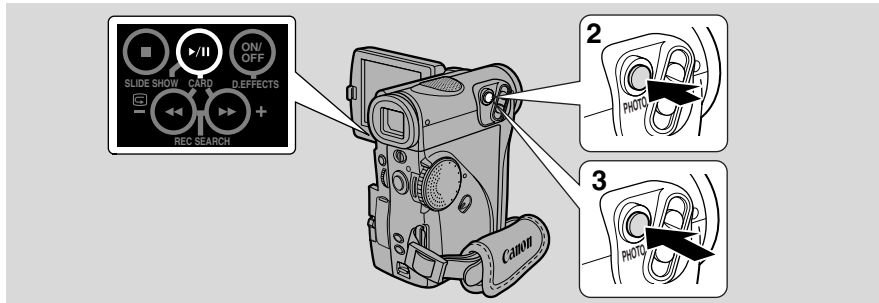

E

Record an image from a cassette onto a MultiMediaCard. To automatically record multiple still images from a cassette to a MultiMedia Card, refer to “Copying Still Images from a Cassette” on p.109.

- For highest image quality, we recommend using an image recorded in Progressive Scan mode ( 48).
- The still image's data code will show the date and time it was originally recorded on the cassette.

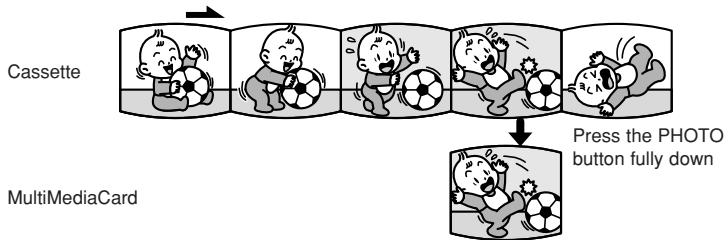

### 1. Play back the cassette.

### 2. When the image you want to record appears in the display, press the PHOTO button halfway down and hold it.

- The tape is set to playback pause mode and the number of images that can still be recorded on the MultiMediaCard appears in the display.
- The display appears to close for an instant as if it were a shutter releasing (except when you are operating the multi-image screen).

### 3. Press the PHOTO button fully down to record the image to the MultiMediaCard.



- You can also set the cassette to playback pause mode in step 1 and record the image with only 1 full press of the PHOTO button.
- If you record an image onto a MultiMediaCard that was originally recorded in the 16:9 mode for widescreen TV's, the image will appear to be vertically “squashed” (compressed).
- The shutter sound does not sound in VCR mode.

Using the MultiMediaCard  
(ELURA2 MC only)

## Recording from Another DV Device as a Still Image

E

### -ELURA2 MC only-

Record images input through the DV in terminal onto the MultiMediaCard as still images.

- The still image's data code will show the date and time it was originally recorded.

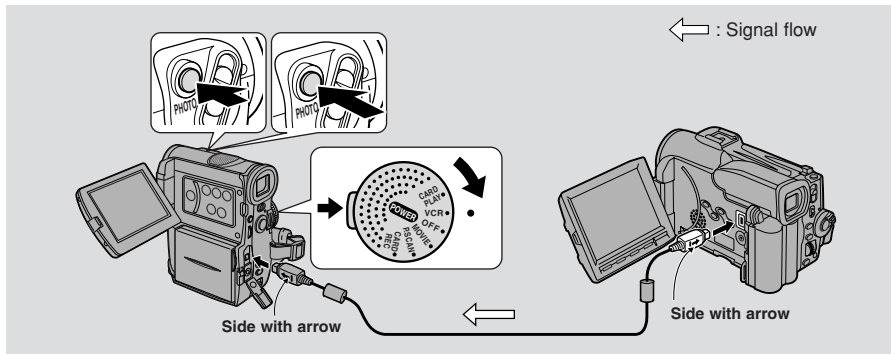

### Preparations

- 1. Connect the camera to the other digital device.**
  - Connect the Canon CV-150F DV cable (optional) with the sides of the plugs marked with the arrows facing as shown above.
- 2. Prepare the other device.**
  - Turn on the power and load a recorded cassette.
- 3. Load a MultiMediaCard. Then push the button next to the POWER dial and hold, and turn the POWER dial to VCR.**
  - DV IN appears in the display.
  - If you have a cassette inserted, make sure it is in stop mode.

### Recording



- 1. Start playback on the other device.**
- 2. When the image you want to record appears in the display, press the PHOTO button halfway down and hold it.**
  - The image appears as a still image in the display.
  - The number of images that can still be recorded on the MultiMediaCard appears in the display.
- 3. Press the PHOTO button fully down to record the image to the MultiMediaCard.**



- If you record an image onto a MultiMediaCard that was originally recorded in the 16:9 mode for widescreen TV's, the image will appear to be vertically "squashed" (compressed).
- The shutter sound does not sound in VCR mode.

Using the MultiMediaCard  
(ELURA2 MC only)

## Viewing Still Images



-ELURA2 MC only-

E

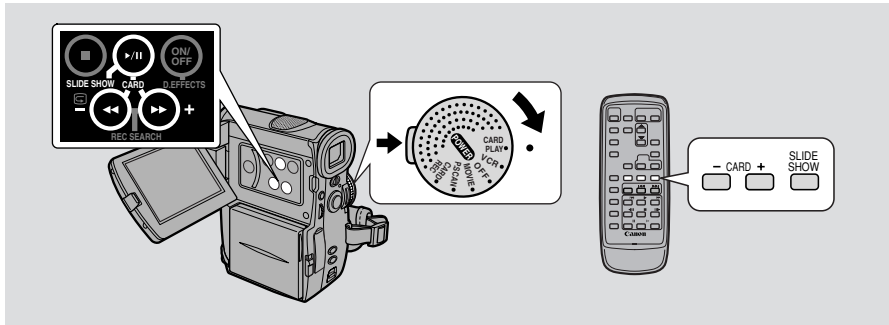

Play back and view still images recorded on a MultiMediaCard. (For details on connecting to a TV, see “Connections for Playback on a TV Screen” on p. 28)

- The camera may not be able to copy or play, etc., images recorded on a non-Canon camera or enhanced on a PC.

There are 3 ways to view still images:

- Single image
- Slide show: One after the other automatically in order of recording
- Index: Six images at once

Make sure a MultiMediaCard that has images recorded on it is inserted into the camera.

### ● Single Image

1. **Push the button next to the POWER dial and hold, turn the POWER dial to CARD PLAY.**
  - The last image recorded appears in the display.
2. **Search for the desired still image by pressing the CARD +/- buttons.**
  - Press + to view the next image and – to view the previous image.
  - Pressing + at the last image will take you to the first image. Pressing – at the first image will take you to the last image.

Using the MultiMediaCard  
(ELURA2 MC only)

**E**

● **Slide Show**

**With an image in the display, press the SLIDE SHOW button.**

- The images play back one after the other for 5 seconds each.

To stop the slide show, press the SLIDE SHOW button.

- The slide show starts or stops each time you press the SLIDE SHOW button.
- The slide show stops with the last image appearing in the display.

● **Index**

Up to 6 images appear at once so you can search quickly for an image.

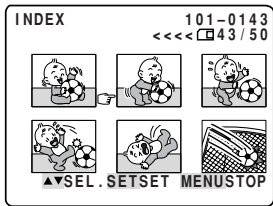

**MENU**

( 34)



- 1. Open the menu and select CARD OPER.**
- 2. Select INDEX.**
  - Up to 6 images appear in the display.
- 3. Move the  mark to the image you want to view.**
  - Turn the SELECT dial downwards to go to the previous image and upwards to go to the next image.
  - Turning the dial upwards at the last image will take you to the next image. Turning the dial downwards at the first image will take you to the previous image.
  - Jump to the next/previous index screen with the CARD +/- buttons.
- 4. Press the SELECT dial in.**
  - The image you have marked fills the whole display.



Using the MultiMediaCard  
(ELURA2 MC only)

## Preventing Accidental Erasure (Protect)



-ELURA2 MC only-

E

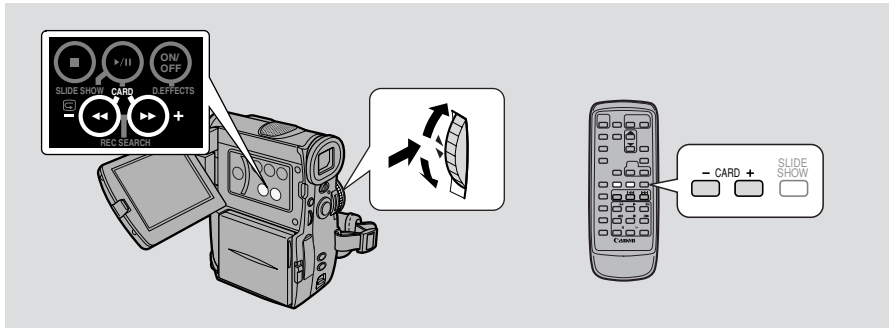

Select important images and protect them from accidental erasure. If a MultiMediaCard is formatted, however, all images, including protected images, will be permanently erased ( 112).

- The pre-recorded sample images provided on the MultiMediaCard are already protected.

CARD  
PLAY

**MENU**

( 34)

▶ CARD OPER.

▶▶▶ PROTECT ON

Make sure a MultiMediaCard that has images recorded on it is inserted into the camera.

1. Open the menu and select **CARD OPER.**
2. Select **PROTECT ON**.
  - Up to 6 images appear in the display.
3. Move the mark to the image you want to protect.
  - Turning the SELECT dial downwards takes you to the previous image and upwards takes you to the next image.
  - Turning the dial upwards at the last image will take you to the next image. Turning the dial downwards at the first image will take you to the previous image.
  - Jump to the next/previous index screen with the CARD +/- buttons.
4. Press the **SELECT** dial in.
  - The protect mark appears on the image.
  - Now you are unable to erase this image.
5. Close the menu.



- To cancel image protection, move the mark to the protected image and press the SELECT dial in. The protect mark disappears.

Using the MultiMediaCard  
(ELURA2 MC only)

103

## Erasing Still Images



**E**

**-ELURA2 MC only-**

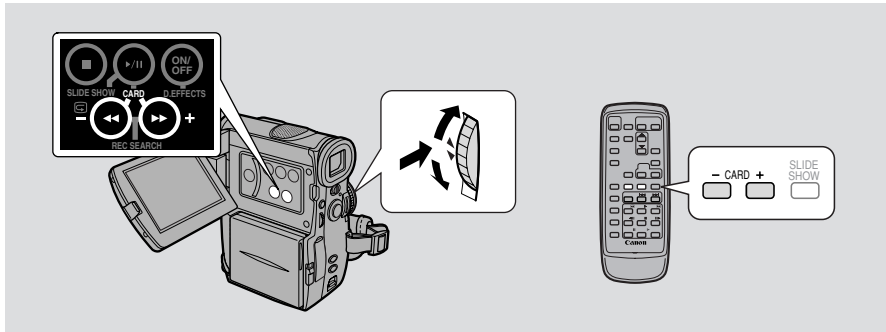

Erase images singly or all at once.

- You cannot erase protected images. Cancel image protection ( 103) first in order to erase an image.
- Erase images with caution. Once an image has been erased it cannot be restored.

**CARD PLAY**

**MENU**

( 34)

►CARD OPER.

►IMAGE ERASE

Make sure a MultiMediaCard that has images recorded on it is inserted into the camera.

1. **Move to the image you want to erase with the CARD +/- buttons.**
2. **Open the menu and select CARD OPER.**
3. **Select IMAGE ERASE.**
  - CANCEL, SINGLE and ALL settings appear.
  - To cancel erasing, select CANCEL and close the menu.

To erase images one at a time

4. **Select SINGLE.**
  - ERASE THIS IMAGE? NO YES appears in the display.
5. **Select YES.**
  - The image erases and the previous image appears for erasing.
  - If the image you are trying to erase is a protected image, YES appears in purple and is unselectable.
  - If you select NO, you return to step 4.
6. **Close the menu.**

Using the MultiMediaCard  
(ELURA2 MC only)



To erase all images on the MultiMediaCard at once



**4. Select ALL.**

- ERASE ALL IMAGES? [EXCEPT FOR  IMAGES] NO YES appears in the display.

**5. Select YES.**

- All images except the protected ones are erased.
- If you select NO, you return to step 3.

**6. Close the menu.**



Using the MultiMediaCard  
(ELURA2 MC only)

**Combining Images and Recording Them to a Cassette (Card Mix)**  

**E**

**-ELURA2 MC only-**

Liven up your productions by superimposing one image on top of the other. Combine 2 still images or a still image and a moving image. Choose a still image from the MultiMediaCard, either one of the pre-recorded sample images (  114) or one you have recorded yourself, then combine it with the currently recording image, moving or still.

**Availability of Card Mix by mode**

	MOVIE	P.SCAN	PHOTO	VCR	CARD REC	CARD PLAY
CARD MIX	○	○	○	×	×	×

Select from 3 types of Card Mix effects:

**CARD CHROMA (Card chroma key)-** 8 pre-recorded sample images

The currently recording image appears in place of the blue area of a prerecorded still image such as a picture frame. When recording your own still image for overlapping, make sure to record the area in which you want the new image to appear blue, with a blue curtain as a background, for example. Adjust the mix level in the blue area of the pre-recorded image.

Image being recorded by the camera



Still image



**CARD LUMI. (Card luminance key)-** 5 pre-recorded sample images

The currently recording image appears in place of the light area of a still picture such as a handwritten illustration or title. Make your own by drawing or writing on a white piece of paper. Adjust the mix level in the light area of the still image.

Image being recorded by the camera



Still image



Using the MultiMediaCard (ELURA2 MC only)



**CAM. CHROMA (Camera chroma key)**- 2 pre-recorded sample images  
 Superimpose the currently recording image on top of a still image, which becomes its background. Shoot the subject of the currently recording image against a blue background, such as a blue curtain. The original still image will appear in place of the blue area. Adjust the mix level in the blue area.

Image being recorded by the camera



+

Still image



→



**Mix level**

The mix level bar appears. Adjust the mix level using the – and + at the ends of the bar as guides.

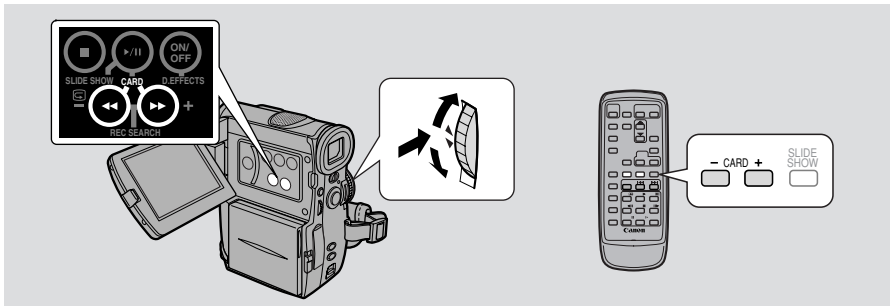

**MENU**  
 ( 34)

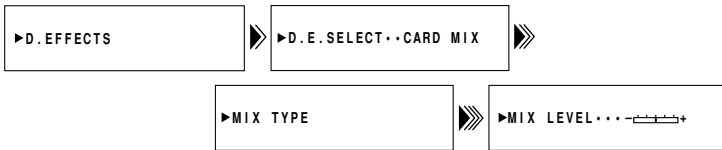

Make sure a MultiMediaCard that has images recorded on it and a cassette have been inserted into the camera.

Make sure the program selector is set to **[P]**.

Select

1. Open the menu and select **D. EFFECTS**.
2. Select **D.E.SELECT**.
3. Select **CARD MIX**.
  - You return to the D.EFFECTS submenu.
4. Select **➡CARD MIX** again.

Using the MultiMediaCard  
 (ELURA2 MC only)

**E****5. Press the CARD +/- buttons to select the still image to be combined.**

- Your currently recording image is combined with the pre-recorded still image.

**6. Select MIX TYPE.**

- CARD CHROMA, CARD LUMI., CAM. CHROMA settings appear.

**7. Select the desired setting.****8. Select MIX LEVEL.****9. Adjust the mix level.**

- Turning the SELECT dial upwards adjusts to the left and turning downwards adjusts to the right.

**10. Close the menu.**

- The name of your selection flashes in the display.

On/Off

**11. Press the D.EFFECT ON/OFF button.**

- The name of your selection stops flashing.
- Each time you press the ON/OFF button, your selection is activated (display lights continuously) or deactivated (display flashes).

For a moving image

**1. Press the start/stop button to start and stop recording.**

- The combined images are recorded onto the cassette.

For a still image



**1. Press the PHOTO button halfway down and hold it.**

-  flashes white in the display as the camcorder adjusts the focus and it is displayed continuously as a green mark when the camera is ready to take the image.

**2. Press the PHOTO button fully down to record the image to the cassette.**

-  disappears from the display.
- The combined images are recorded onto the cassette for approximately 6 seconds.



- You cannot use Card Mix in the Low Light recording program (in MOVIE and P.SCAN modes).
- If you change the position of the POWER dial or move the program selector from  to  Easy Recording mode, select your still image for Card Mix again.
- When setting Card Mix, you must carry out steps 1 to 5.

Using the MultiMediaCard  
(ELURA2 MC only)

108

## Copying Still Images from a Cassette



-ELURA2 MC only-

E

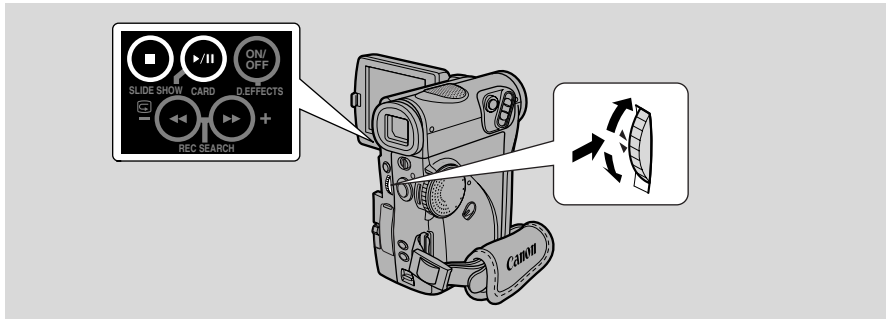

Copies multiple still images from a tape to the MultiMediaCard, using the Photo Search function.

- The still images' data codes will reflect the date and time the copies are made.

VCR

### MENU

( 34)

▶CARD OPER.

▶COPY [ ] [ ]

Make sure a MultiMediaCard that has enough memory available and a recorded cassette have been inserted into the camera.

- 1. Locate the first still image on the cassette that you want to copy and stop the cassette at a point before that image.**
  - All the still images on the cassette after that point will be copied onto the MultiMediaCard.
  - If you want to copy all the images on a cassette, rewind the cassette to the beginning.
- 2. Open the menu and select CARD OPER.**
- 3. Select COPY [ ] [ ] .**
- 4. Select EXECUTE.**
  - Select CANCEL to stop copying.
  - Cassette and card information appear in the display and copying starts.
  - NOW COPYING [ ] [ ] appears in the display.
  - The camera automatically performs the Photo Search function to locate still images and copying starts. The currently copying image appears in the display.
  - Copying stops when the cassette is finished or the MultiMediaCard is full. When the MultiMediaCard is full, CARD FULL will appear in the display.
- 5. Press the stop button when your desired images have finished copying.**

Using the MultiMediaCard  
(ELURA2 MC only)

## Copying MMC Still Images to a Cassette



-ELURA2 MC only-

E

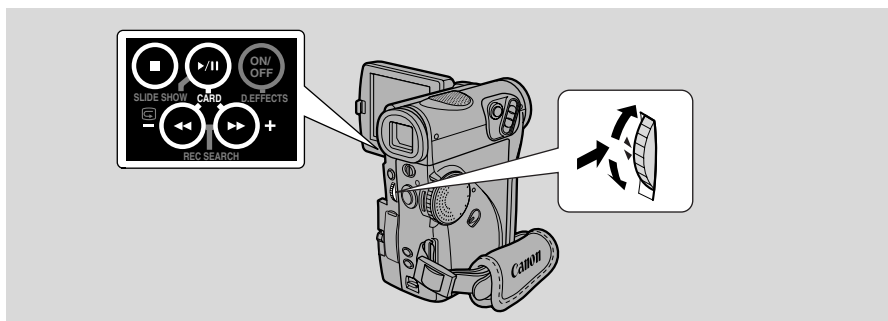

Copies multiple still images from the MultiMediaCard to a cassette.

- The still images' data codes will reflect the date and time the copies are made.

**MENU**  
( 34)

▶CARD OPER.

▶COPY [ → ]

Make sure a MultiMediaCard that has images recorded on it and a cassette that has enough recordable space have been inserted into the camera.

**VCR**

1. Locate the point on the cassette where you want to start copying and set it to stop.

**CARD  
PLAY**

2. Select the first image you want to copy by using the **CARD +/-** buttons.
  - Still images on the MultiMediaCard including and after that image will be copied onto the cassette.
  - If you want to copy all the still images on the MultiMediaCard, select the first image.
3. Open the menu and select **CARD OPER.**
4. Select **COPY** [ → ].
5. Select **EXECUTE**.
  - Select **CANCEL** to stop copying.
  - Cassette and card information appear in the display and copying starts.
  - **NOW COPYING** [ → ] appears in the display.
  - Each image is copied for about 6 seconds on the cassette.
  - Copying stops when all the images have been copied or the tape is full.
6. Press the stop button when your desired images have finished copying.

Using the MultiMediaCard  
(ELURA2 MC only)

110

## Marking a Still Image for Printing (Print Mark)



-ELURA2 MC only-

E

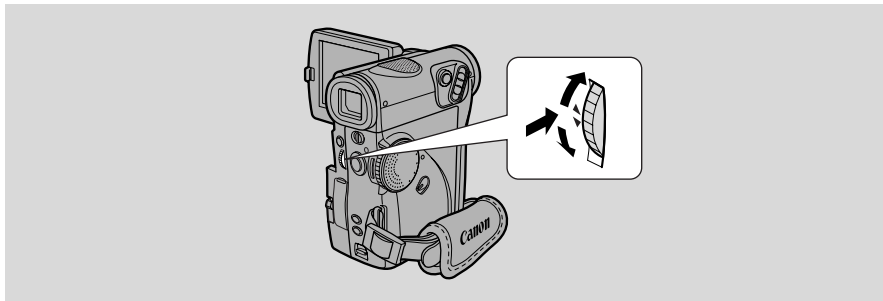

An image on a MultiMediaCard must be marked before it can be printed. The camera supports the **DPOF** (Digital Print Order Format) print format. Images can be automatically printed on a DPOF-supporting Canon printer. Up to 50 images per MultiMediaCard can be print marked.

CARD  
PLAY

**MENU**

( 34)

▶CARD OPER.

▶▶PRINT MARK▶

Make sure a MultiMediaCard that has images recorded on it has been inserted into the camera.

### 1. Open the menu and select **CARD OPER.**

### 2. Select **PRINT MARK** **▶**.

- Up to 6 images appear in the display.

### 3. Move **▶** to the image you want to mark.

- Turning the **SELECT** dial downwards takes you to the previous image and upwards takes you to the next image.
- Turning the dial upwards at the last image will take you to the next image. Turning the dial downwards at the first image will take you to the previous image.
- Jump to the next/previous index screen with the **CARD +/-** buttons.

### 4. Press the **SELECT** dial in.

- The **▶** print mark appears next to the image.

### 5. Close the menu.



- To cancel a print mark, move **▶** to the print-marked image and press the **SELECT** dial in. The **▶** print mark disappears.
- If there are a large number of images recorded on the MultiMediaCard, it may take time for a print mark to appear on an image.

Using the MultiMediaCard  
(ELURA2 MC only)

111

## Formatting a MultiMediaCard

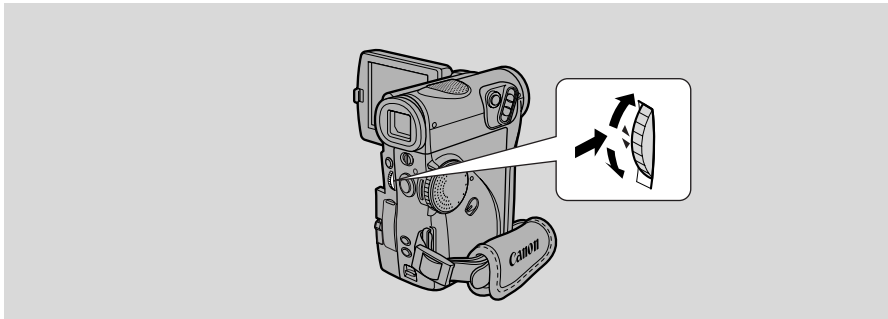
**E**
**-ELURA2 MC only-**

Format new MultiMediaCards, if you get the message **CARD ERROR**, or to permanently and quickly erase all the images on a MultiMediaCard, including protected images (this includes the pre-recorded card mix sample images). The MultiMediaCard supplied with this camera has already been formatted for you.

- Be cautious when formatting recorded MultiMediaCards. All images will be permanently erased.

**CARD  
PLAY**
**MENU**

( 34)

►CARD OPER.

►►FORMAT

Make sure a MultiMediaCard is inserted into the camera.

1. **Open the menu and select CARD OPER.**
2. **Select FORMAT.**
3. **Select EXECUTE.**
  - Select CANCEL to cancel formatting.
  - FORMAT THIS CARD? NO YES appears to confirm.
4. **Select YES.**
  - Formatting starts and NOW FORMATTING appears in the display.
  - If you select NO, you return to step 3.
5. **Close the menu.**

Using the MultiMediaCard  
(ELURA2 MC only)



## Other Information and Precautions

The camera formats MultiMediaCards in DCF (Design Rule of Camera File System).

Images recorded on a MultiMediaCard with this camera can be transferred to a PC with the use of the following products:

**PC Card Adapter:** Holds a MultiMediaCard then inserts into the PC card slot found on most types of laptop PCs.

**MultiMediaCard Reader:** Connects to a PC, then accepts a MultiMediaCard.

**FD Adapter:** Holds a MultiMediaCard then inserts into a PC's floppy disk drive.

If you need extra MultiMediaCards in addition to the supplied one, use cards made by SanDisk Corporation.

If you mistakenly erase the card mix sample images provided on the MultiMediaCard, they can be downloaded from the following home page:\*

<http://www.canondv.com>

\* You will need a PC Card Adapter or MultiMediaCard Reader to be able to download to a MultiMediaCard.

### MultiMediaCard operating precautions

- If you purchase additional MultiMediaCards, format them with the camera, not a PC or other device. There have been cases where MultiMediaCards formatted with a PC or other device do not function properly.
- We recommend saving backups of MultiMediaCard images on your PC's hard drive or other external memory device. Image data may be damaged or lost due to a defect in a MultiMediaCard, or if a MultiMediaCard is exposed to static electricity. Contents of a MultiMediaCard can not be compensated for should data become damaged or lost.
- Do not remove the power source or the MultiMediaCard while the camera is accessing (recording to, reading, erasing files from or formatting) the MultiMediaCard card.
- Do not use MultiMediaCards in places subject to strong magnetic fields.
- Do not disassemble MultiMediaCards.
- Do not bend or drop MultiMediaCards, or expose them to strong vibrations or external shocks.
- Do not get MultiMediaCards wet.
- Do not remove the MultiMediaCard's label or affix other labels. Affix labels to the MultiMediaCard's case.
- Do not leave MultiMediaCards in places subject to high temperature or high humidity.

**E**

Using the MultiMediaCard  
(ELURA2 MC only)

**113**

**E**

- Moving a MultiMediaCard rapidly between hot and cold temperatures may cause condensation to form on it, leading to malfunctions. Avoid this problem by placing the MultiMediaCard in a plastic bag and letting it slowly adjust to temperature changes before removing it from the bag. If condensation should occur, maintain the MultiMediaCard at a constant temperature and let the moisture evaporate naturally.
- Do not touch the MultiMediaCard's terminals or let dust or dirt come in contact with the terminals. Store and carry MultiMediaCards in their case to protect the terminal area.
- There is only one correct way to insert MultiMediaCards into the camera. Do not forcefully insert the MultiMediaCards backwards or upside down. This could damage the MultiMediaCard or the camera.
- The prerecorded sample images on the MultiMediaCard included with this camera are intended solely for the personal enjoyment gained from combining them with personal videos taken with this camera. Do not use the prerecorded sample images for any other purpose.

#### PhotoEssentials - Royalty Free Stock Photography

The PhotoEssentials suite of royalty-free images on CD-ROM features premium quality assignment photography and is ideally suited for use in advertising, brochures, reports, multimedia, websites, books, packaging and more. For more information, please visit their website [www.photoessentials.com](http://www.photoessentials.com)

### Sample images

The following are the sample images that have been pre-recorded on the included MultiMediaCard. There are a total of 15 images: 8 Card chroma key images, 5 Card luminance key images and 2 Camera chroma key images.

#### Card chroma key

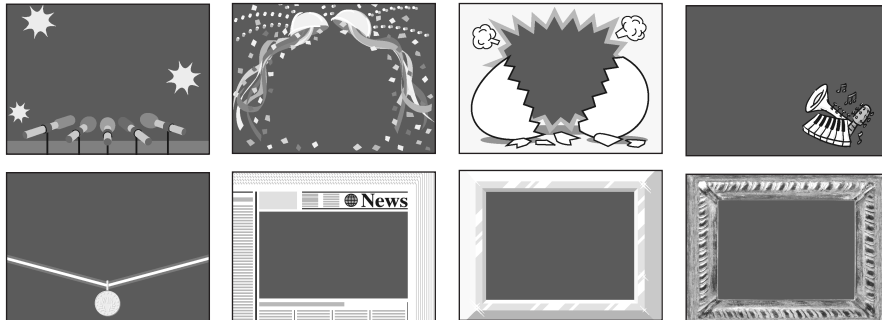

Using the MultiMediaCard  
(ELURA2 MC only)

Card luminance key

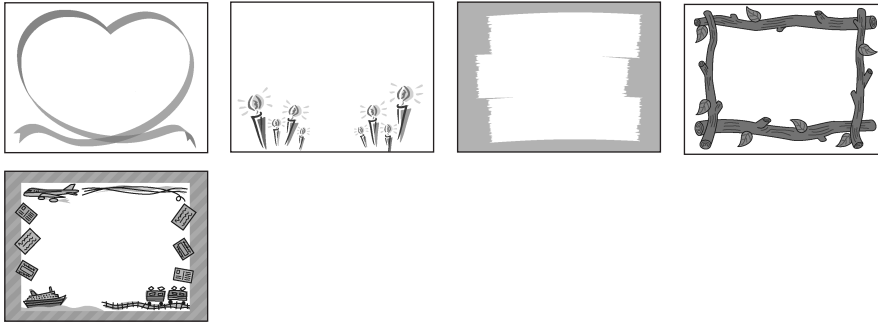

Camera chroma key

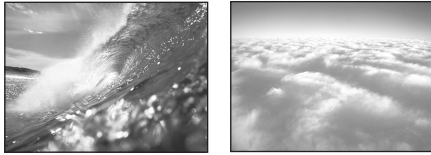

**MultiMediaCard Specifications**

<b>Capacity</b>	8 MB
<b>Interface</b>	MultiMediaCard standard
<b>Operating temperature range</b>	0°C–40°C (32°F– 140°F)
<b>Dimensions</b>	32 × 24 × 1.4 mm
<b>Weight</b>	1.5 g

Weight and dimensions are approximate  
 Errors and omissions excepted.  
 Subject to change without notice.



Using the MultiMediaCard  
 (ELURA2 MC only)

## Preparing the Camera

E

### Adjust the viewfinder

- Turn the POWER dial to MOVIE mode. Extend the viewfinder straight out, then adjust the viewfinder focusing lever to suit your eyesight.
- The viewfinder extends straight out for comfortable viewing. Store the camera with the viewfinder flush with the body of the camera.
- To view with the viewfinder, make sure the LCD panel is either turned so that the subject can monitor viewing, or totally closed with the screen facing inwards.

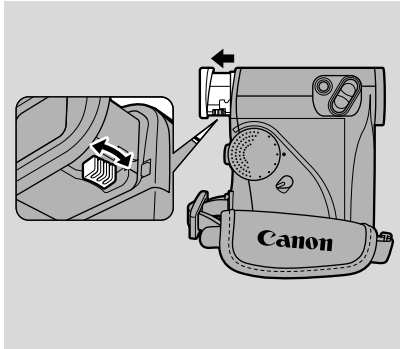

### Prepare the lens cap

- Attach the cord to the lens cap, and pass the grip belt through the loop on the cord.
- Hook the lens cap on to the grip belt while you are recording, and place it over the lens when you have finished.

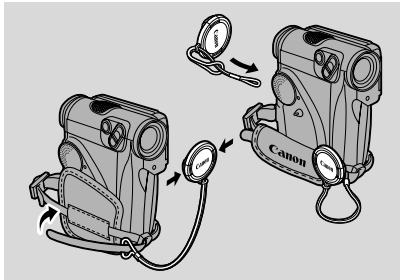

### Fasten the grip belt

- Release the Velcro fastening and hold the camera with your right hand while you adjust the belt with your left. Your index finger should reach the zoom control and photo button, and your thumb should reach the start/stop button comfortably.
- When holding the camera, be sure to avoid touching the lens and the microphone.

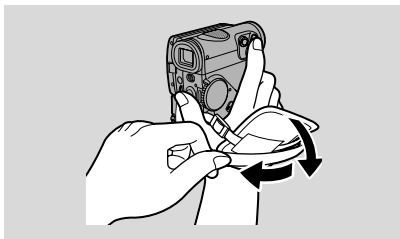

Additional  
Information

Be careful not to leave the viewfinder exposed to bright sunlight, or it will melt. (The light is concentrated by the viewfinder lens.) When not using the viewfinder, return it to its retracted position.

## Notes on Using the Batteries

### Charging and recording times

E

- These times vary — the safest policy is always to have 2 or 3 times as many battery packs as you think you will need.
- You will get more recording time if you turn the camera off between shots, instead of leaving it in record pause mode.

Battery pack		BP-406	BP-422 (optional)
Time needed for full recharge		1 hr. 10 min.	1 hr. 50 min.
Maximum recording time	Using the viewfinder:	55 min.	3 hr. 20 min.
	Using the LCD screen:	45 min.	2 hr. 45 min.

- Recording time will be shorter than usual at low temperatures. You can use the battery pack between 32° and 104°F (0° to 40°C), but it works best between 50° and 86°F (10° to 30°C).
- If the battery pack starts to give you much less recording time than usual, it has reached the end of its life and must be replaced.



- These figures show how long you can view playback with the LCD, after attaching a fully-charged battery pack. Playback time will be shortened at low temperatures.

Battery pack	Playback time (using the LCD screen)
BP-406	55 min.
BP-422	3 hr. 20 min.

### How much power is left?

The indicator in the display shows you approximately how much charge the battery pack has left:



- “CHANGE THE BATTERY PACK” appears in the display for 4 seconds when the power is completely exhausted. The empty battery mark then appears and starts to flash. The power indicator light also flashes.
- The indicator is not constant — different levels will be shown when you subject the battery pack and camcorder to different conditions.

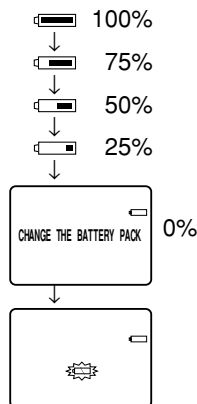

Additional  
Information

**E****When to recharge**

You can recharge a lithium ion battery pack whenever it is convenient. Unlike a conventional battery pack, it does not have to be fully discharged first. However, as the battery pack will naturally discharge itself over time, it is best to charge it the same day you plan to use it, or the day before.

**Taking care of the battery pack****Always attach the terminal cover.**

- Do not allow any metal objects to touch the terminals, as this can cause a short circuit and damage the battery pack. Attach the terminal cover whenever the battery pack is not being used.

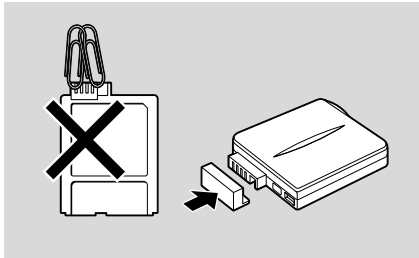
**Keep the terminals clean.**

- Make sure no foreign objects get between the terminals as this can cause a short circuit and damage the battery pack. Attach the terminal cover whenever the battery pack is not being used.

**Storing the battery pack**

- If you do not use a battery pack for a period of more than a few months any remaining charge may cause damage to the battery pack, and reduce usage time. To prevent damage therefore, aim to use a battery pack's complete charge before storage. See the optional battery pack's instructions for further details.

## Installing the backup battery

Open the cassette compartment cover. The cassette compartment will open automatically. If necessary, close it to give yourself more room to install the backup battery. Insert the CR1616 lithium battery as far as it will go with the + side facing outwards. Make sure the cassette compartment is closed and close the cassette compartment cover.

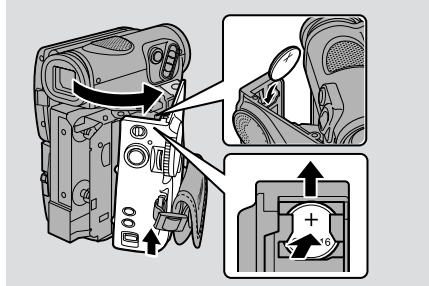

This backup battery allows the camera to remember the date and time and other settings when main power source is removed. It has a life span of about a year. When it needs replacing (or if it has not been installed), the  mark flashes in the display. Press the old battery and slide it up to remove.

### **DANGER!**

#### **Treat the battery pack with care.**

- Keep it away from fire (or it might explode).
- Do not expose the battery pack to temperatures greater than 140°F (60°C). Do not leave it near a heater, or inside a car in hot weather, for example.
- Do not try to disassemble or modify it.
- Do not drop or knock it.
- Do not get it wet.

### **WARNING!**

- The battery used in this device may present a fire or chemical burn hazard if mistreated. Do not recharge, disassemble, heat above 212°F (100°C) or incinerate.
- Replace the battery with a CR1616, made by one of the following companies: Panasonic, Hitachi Maxell, Sony, Toshiba, Varta, Renata. Use of another battery may present a risk of fire or explosion.

### **Cautions:**

- Do not pick up the battery using tweezers or other metal tools — this will cause a short circuit.
- Wipe the battery with a clean, dry cloth to ensure proper contact.
- Keep the battery pack out of reach of children — if it is swallowed, contact a physician immediately, as the battery case may break down and the battery fluids damage the stomach and intestines.
- Do not disassemble, heat or immerse the battery in water, to avoid the risk of explosion.

E

Additional  
Information

119

## Maintenance

### E

#### Cautions

**Avoid high temperatures and high humidity.**

- Do not leave the camera inside a car in hot weather, for example.
- Be careful of heat radiating from video lighting equipment.
- Do not take the camera into a humid room.

**Avoid sudden changes in temperature.**

- If you take the camera from a cold place to a warm place, condensation may form on the lens and internal parts (  123).

**Do not point the lens or viewfinder at strong light sources.**

- Never point it at the sun, and do not leave it aimed at a bright subject.
- Be especially careful when leaving the camera on a tripod.

**Avoid magnetic or electric fields.**

- Do not use the camera close to TV transmitters, portable communication devices or other sources of electric or magnetic radiation. They may cause picture interference, or permanently damage the camera.

**Do not expose the camera to water.**

- Cover the camera when you are recording in rain or mist.
- There is a risk of electric shock if water gets inside the camera — contact qualified service personnel as soon as possible.

**Protect the lens.**

- Sand and dust can damage the lens — be especially careful on windy days.

**Handle the camera gently.**

- Vibration or shock can cause damage.
- Do not use the viewfinder or LCD panel as a carrying handle.

**Do not disassemble the camera.**

- This is very dangerous as there is a risk of electric shock — if the camera does not function properly, take it to qualified service personnel.



## Storage

E

If you do not intend to use the camera for some time, store it in an area which is free of dust and moisture, and where the temperature is no higher than 86°F (30°C). After storage, check each part and function of your camera to make sure everything is still working properly.



- These cautions also apply to accessories such as battery packs and cassettes.

## Maintenance

### Viewfinder

- Clean the viewfinder screen using a cotton swab. First, pull the viewfinder out until it stops. Then, press and hold the finder release button with a sharp object and pull the viewfinder all the way out. To reattach the viewfinder, first position the base horizontally and align it with the viewfinder's base. Then press it until it clicks back into place. Don't touch anyplace other than the glass screen.
- The viewfinder screen scratches easily. Take care when cleaning.

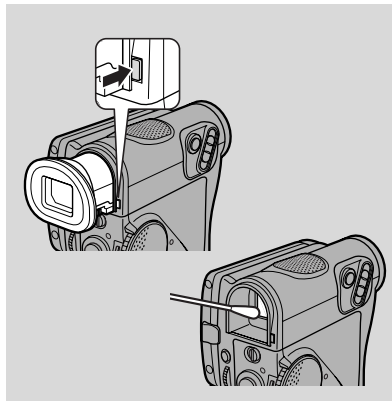

### LCD

- Clean the LCD screen using a commercially available cleaning cloth for glasses.
- Where there is a big change in temperature, moisture may form on the surface of the screen. Wipe clean with a soft, dry cloth.
- At low temperatures the display may appear to be much darker than usual. This is not a fault, and as the screen warms up the display will return to normal.

### Camera body and lens

- Use a soft, dry cloth to clean the camera body or lens. Never use chemically treated cloth or volatile solvents such as paint thinner.

### Video heads

- When mosaic-like noise appears on the playback picture, the video heads may be dirty. When the video heads are badly contaminated, the camera may show a blank blue screen or a warning.
- For the best picture possible, after using the camera for approximately 20 hours, clean the video heads using Canon's DVM-CL Digital Video Head Cleaning Cassette. If the "noise" remains, repeat the cleaning (up to maximum of 5 times).
- Do not use a wet-type cleaning cassette, as this can cause damage.



Additional Information

**E**

## Using the camera abroad

### Power sources

- You can use the compact power adapter to operate your camera and charge battery packs in any country where the electricity supply is between 100 and 240 V AC, 50/60 Hz. Contact your Canon dealer for information about plug adapters for overseas use.

### TV playback

- Although you can always play back your recordings on the LCD screen, your camera can only be connected to TVs which use its NTSC system. This TV system is used in the following countries:  
American Samoa, Bahama, Barbados, Bermuda, Bolivia, Canada, Chile, Columbia, Costa Rica, Cuba, Ecuador, El Salvador, Guam, Guatemala, Greenland, Haiti, Honduras, Jamaica, Japan, Korea, Mexico, Micronesia, Myanmar, Nicaragua, Panama, Peru, Philippines, Puerto Rico, Saint Lucia, Surinam, Taiwan, Trinidad and Tobago, USA, Venezuela.

## Condensation

E

Condensation may form on the camera when it is moved from a cold place to a warm place. Using the camera while condensation is present can damage both the tape and the camera.

Condensation may become a problem:

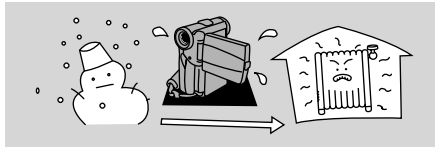

When you take the camera from a cold place to a warm room

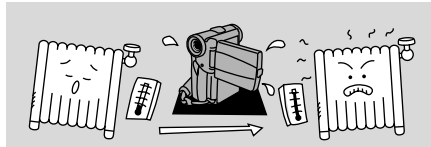

When a cold room is heated rapidly

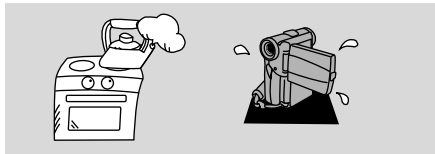

When the camera is left in a humid room

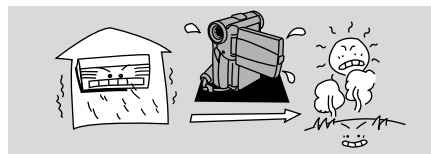



When the camera is taken from an air-conditioned room to a warm, humid place

### Protecting the camera from condensation

- Before you take the camera to a warm or humid place where condensation is likely to be a problem, unload the cassette and put the camera in a plastic bag. Wait until the camera reaches room temperature before you take it out of the bag.

### What happens when condensation is detected

- “CONDENSATION HAS BEEN DETECTED” is displayed for approximately four seconds. Then, the power indicator flashes and the  mark flashes in the display. If there is a cassette in the camera, it stops automatically and “REMOVE THE CASSETTE” is displayed for approximately 4 seconds and then  flashes in the display. If you have the beep turned on, it will sound.
- The camera may not detect the condensation immediately — the condensation warning may not start flashing for 10 to 15 minutes.
- You cannot load a cassette when condensation is detected.

### What you should do

- Remove the cassette, leave the cassette compartment open, and turn the camera off.
- Leave it in a dry place until the condensation evaporates. After the condensation warning stops flashing, wait at least another hour before trying to use the camera.

Additional  
Information

## Troubleshooting

**E**

Refer to this checklist first if you have any problems with your camcorder. Possible explanations are given for each problem on the list — turn to the page numbers in parentheses for more information.

Make sure that the camera is properly connected if you are using it with a TV or VCR. Consult your dealer or service outlet if problems persist.

### Recording/Playback

#### Problem

**2** Nothing happens when I press the buttons.

**2** The camera turned itself off.

**2** The cassette compartment stopped mid-operation while loading/unloading a cassette.

**2** The start/stop button doesn't work.

**2** There's no picture in the display.

**2** There's a blank blue screen in the display.

**2** The camera won't focus.

#### Cause and/or what to do about it

- The POWER dial is not set to the appropriate mode ( 16, 24).
- The cassette is not loaded or is set for erasure prevention ( 14-15).
- The cassette has reached the end.
- The power source is not properly connected, or the battery pack is exhausted or not properly attached ( 11-13, 117).
- The function cannot be used in that recording program ( 53).
- The camera was in record pause mode for more than about 5 minutes ( 16, 97).
- The battery pack is exhausted ( 12-13, 117).
- The battery pack's power is exhausted. Recharge or change to a new battery pack ( 12).
- The cassette is not loaded or is set for erasure prevention ( 14-15).
- The cassette has reached the end.
- The POWER dial is not set to the appropriate mode ( 16, 97).
- You are attempting to play back or record copyright protected material ( 82).
- The video heads are badly contaminated ( 121).
- The camera is on manual focus ( 72).
- The viewfinder lens needs adjusting ( 116).
- The lens is dirty ( 121).

Additional Information



- Some subjects are not suitable for autofocus. In these situations, you will often get better results using manual focus (  72). Focus on something which is about the same distance away, lock the focus, and then point the camera at your original, hard-to-focus subject.

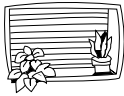

Horizontal stripes



Many subjects at different distances



Behind glass

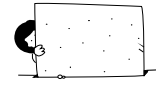

Without much contrast (e.g. a white wall)

Reflective surfaces  
(e.g. shiny car surfaces)

Fast moving objects



Slanted subjects



Dark subjects



Night scenes



## Recording/Playback (Contd.)

### Problem

- ❑ **Some/all of the digital effects don't work.**
- ❑ **The ► (play) button doesn't work.**
- ❑ **There's a bright stripe on the screen.**



### Cause and/or what to do about it

- There are a number of restrictions on using the digital effects. (  57-64).
- The POWER dial is not set to VCR (  24).
- The cassette is not loaded (  14).
- The cassette has reached the end.
- When recording in dark places a bright light in the scene may cause a vertical light bar ("smear") to appear. This is a normal feature of camcorders.

**E**

- ❑ **The playback picture is rough (with mosaic-like noise).**
  - The video heads need cleaning ( 121).
- ❑ **There's no picture on the TV screen, even though the tape is moving.**
  - The video heads need cleaning ( 121).
  - The TV/VIDEO selector on the TV isn't set to VIDEO ( 28).
- ❑ **There's no sound coming from the speaker during playback.**
  - The speaker has been turned off with the SELECT dial ( 27).
  - Headphones are being used.

### MultiMediaCard operations ELURA2 MC only

#### Problem

- ❑ **The MultiMediaCard will not insert.**
- ❑ **The  mark flashes red in the display even though a MultiMediaCard has been inserted.**
- ❑ **Nothing happens when I press the buttons.**

#### Cause and/or what to do about it

- It is not turned the right way ( 94). Turn it the right way and try inserting again.
- Turn the camera's power off and back on again and remove and reinsert the card if necessary.
- The POWER dial is not set to CARD REC or CARD PLAY ( 97, 101).
- The MultiMediaCard is not inserted ( 94).
- The MultiMediaCard is full. Erase images ( 104) or insert a new MultiMediaCard.
- The power source is not properly connected ( 11), or the battery pack is exhausted or not properly attached ( 12).
- The function can not be used in that recording program ( 53).

Additional  
Information

- ❗ The PHOTO button doesn't work.**
- The MultiMediaCard is not loaded ( 94).
  - The MultiMediaCard is full. Erase images ( 104) or insert a new MultiMediaCard.
  - You have reached the maximum file number. Set the file numbering to RESET through the menu ( 96) and insert a new MultiMediaCard.
  - You are using an unformatted MultiMediaCard. Format the card ( 112).
- ❗ The image cannot be erased.**
- The image is protected ( 103).

E

## Miscellaneous

### Problem

- ❗ The wireless controller doesn't work.**

- ❗ The power indicator is flashing.**

- ❗ The camera malfunctions.**

- ❗ The DV cable is connected correctly, but there's nothing in the display.**

- ❗ The camera becomes warm during use.**

### Cause and/or what to do about it

- The remote sensor mode is set to OFF ( 43) in the menu ( 43).
- The remote sensor modes of the wireless controller and the camera itself are different ( 43).
- The batteries are dead or not inserted.
- Check the screen displays ( 132).
- External interference may cause the camera's microprocessor to malfunction temporarily. If random letters appear in the display or if normal operation is interrupted, remove and then replace the power source.
- Remove the cable and then reconnect it or turn the power off and back on again.
- This is not a malfunction.

Additional  
Information

# The ELURA2/ELURA2 MC System Diagram (Availability differs from area to area)

E

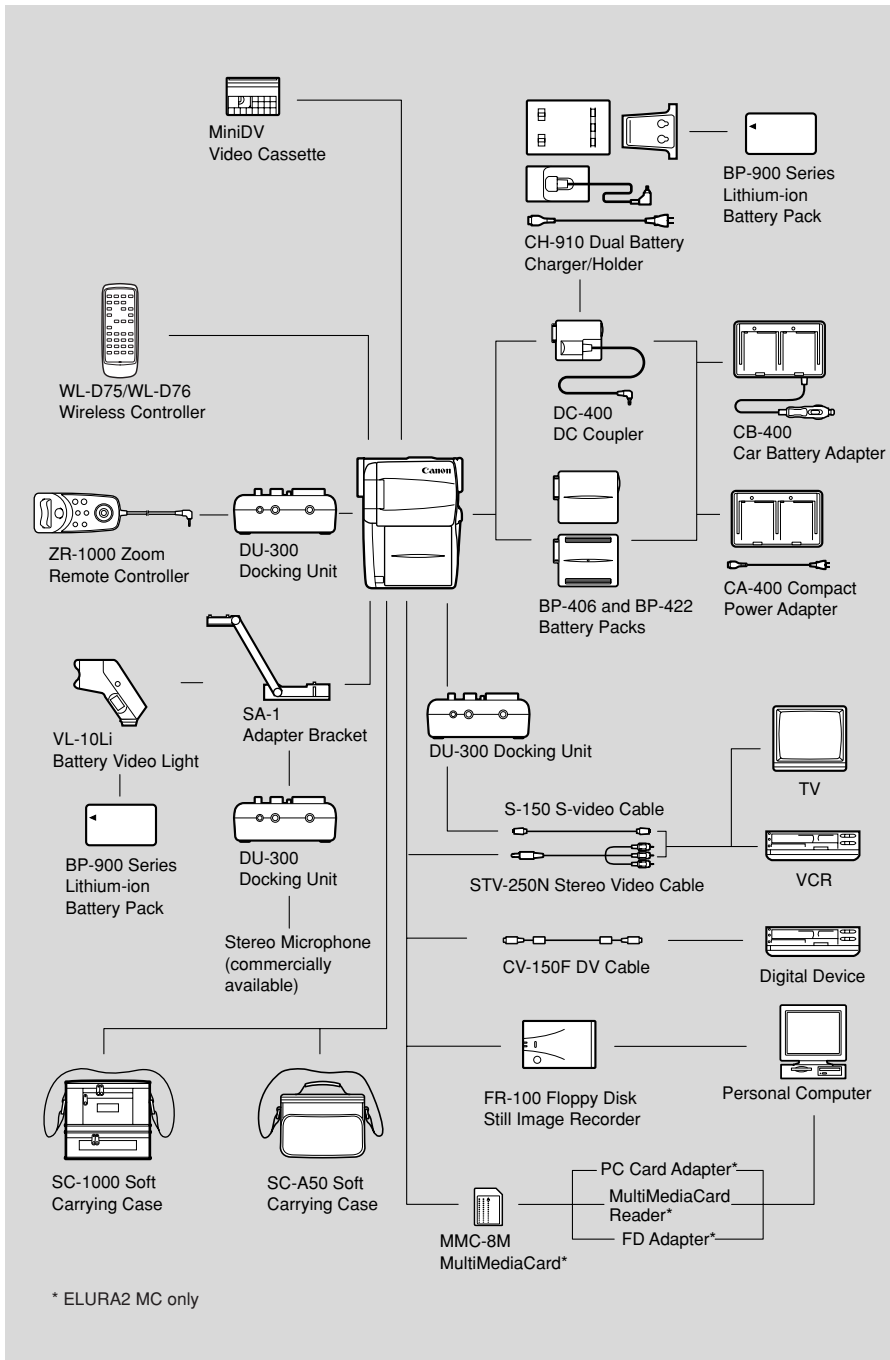

\* ELURA2 MC only

Additional Information



## Optional Accessories

Call or visit your local retailer/dealer for genuine Canon video accessories. You can also obtain genuine accessories for your Canon camcorder by calling: 1-800-828-4040, Canon U.S.A. Information Center.

E

### BP-400 Series Battery Packs

Extra batteries for use with the ELURA2/ELURA2 MC.

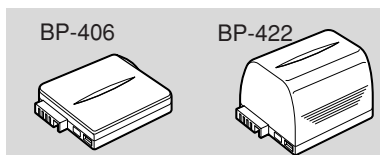

### CH-910 Dual Battery Charger/ Holder

This holds two battery packs and can charge them both consecutively. It can then be connected directly to the ELURA2/ELURA2 MC to give twice the playback time. It can also make use of the higher performance battery pack BP-945, to give up to 11 hours 40 min. recording time. The lithium ion battery packs used with the CH-910 (BP-900 series Battery Pack) differ from the battery pack used with the ELURA2/ELURA2 MC, and can be purchased as optional accessories.

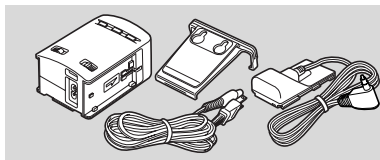

#### Note:

- The DC-400 DC Coupler (supplied with the camera) connects directly to the CH-910. Use it in place of the DC Coupler that is supplied with the CH-910.

### Maximum recording time

		BP-915	BP-930/BP-930R	BP-945
One battery pack attached	Using LCD screen	1 hr. 30 min.	2 hr. 50 min.	4 hr. 40 min.
	Using viewfinder	1 hr. 55 min.	3 hr. 30 min.	5 hr. 50 min.
Two battery packs attached	Using LCD screen	3 hr.	5 hr. 40 min.	9 hr. 20 min.
	Using viewfinder	3 hr. 50 min.	7 hr.	11 hr. 40 min.

Additional Information

**E****CB-400 Car Battery Adapter**

Power your camera, or recharge battery packs on the move. The car battery adapter plugs into your car's cigarette lighter socket and runs off a 12-24 V DC negative ground battery. Available autumn 2000.

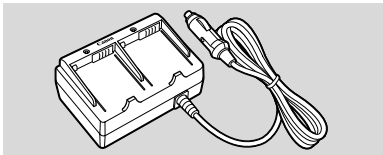
**VL-10Li Battery Video Light**

This compact yet powerful video light can be used for both indoor and outdoor shooting.

- Use the BP-900 Series battery packs to power the light. Approximate usage times are as follows:  
BP-915 60 min. BP-930 120 min.  
BP-945 170 min.
- Charge the BP-900 Series battery packs with the CA-910 Compact Power Adapter or CH-910 Dual Battery Charger/Holder (optional).

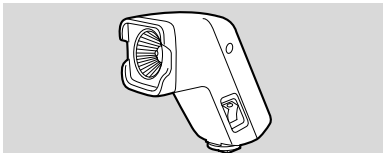
**Zoom Remote Controller ZR-1000**

When this product is plugged into the LANC  terminal of a Canon camcorder, it is possible to control functions such as the start and stop of recording and the zoom and focusing functions while the camcorder is mounted on a tripod, without touching the camcorder body itself.

- To use this product, first connect the DU-300 Docking Unit to the camera.

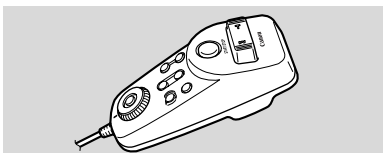
**SA-1 Adapter Bracket**

Attaches a video light or microphone securely to the camera.

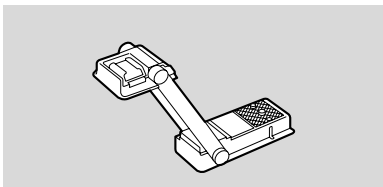

Additional  
Information

**SC-1000 Soft Carrying Case**

A handy camera bag with padded compartments and plenty of space for accessories.

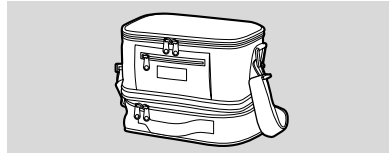

E

**SC-A50 Soft Carrying Case**

This lightweight bag keeps the camera within easy reach without weighing you down or getting in the way. Genuine leather.

**FR-100 Floppy Disk Still Image Recorder**

The FR-100 captures images taken with your digital camcorder, compressing them in JPEG format and recording them as still images onto a floppy disk. Image files can then be easily opened and viewed on your computer.

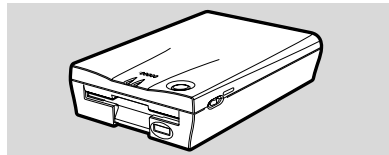

This mark identifies genuine Canon video accessories. When you use Canon video equipment, we recommend Canon-brand accessories or products bearing the same mark.

**Provided accessories:**

WL-D76 Wireless Controller	D83-0572-000
WL-D75 Wireless Controller	D83-0562-000
CA-400 Compact Power Adapter	D85-1250-201
BP-406 Battery Pack	D85-1280-000
S-150 S-video Cable	D82-0330-000
STV-250N Stereo Video Cable	D82-0590-000
Lens cap	D52-0130-000

**Optional accessories:**

CB-400 Car Battery Adapter	D85-1262-002
CH-910 Dual Battery Charger/Holder	D85-1072-002
SA-1 Adapter Bracket	D89-0500-202
SC-1000 Soft Carrying Case	D81-1200-001
SC-A50 Soft Carrying Case	D81-1302-201
VL-10Li Battery Video Light	D86-0081-201
ZR-1000 Zoom Remote Controller	D83-0540-002
FR-100 Floppy Disk Still Image Recorder	D89-0732-002
DVM-CL Digital Video Head Cleaning Cassette	D36-0032-201

**Additional  
Information**

## Screen Displays

**E**

To display the date and time, press the DATA CODE button. See also p. 75.

Press the wireless controller's TV SCREEN button or turn TV SCREEN on through the menu to see the other displays on the TV screen. (The displays appear white on-screen.) They will not be added to any recordings you make with the camera.

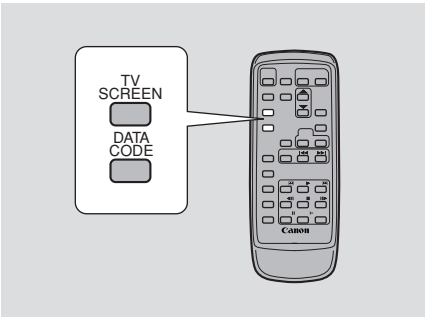

**MENU**  
( 34)

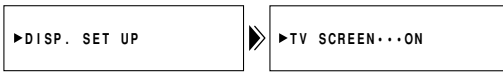

**To turn TV SCREEN off, open the menu and select DISP.SET UP. Then select TV SCREEN, set it to OFF and close the menu.**

For instructions on how to hook the camera up to your TV, see p. 28.

### Turning off the LCD screen displays



You can turn off the displays to give you a clear screen for playback.



**MENU**  
( 34)



**To turn the displays off, open the menu and select DISP. SET UP. Then select DISPLAYS, set it to OFF and close the menu.**

- If you turn the displays off, the LCD screen will be completely blank, but the camera will continue to show warning/caution displays when necessary.

 indicates a flashing display.

**Additional Information**

Record pause mode  
( 16)



Recording ( 17)



The backup battery is not properly installed, or needs replacing ( 119).



Shows how much battery power remains ( 117).



Fast forward ( 24)



The battery pack is exhausted ( 117).



Rewind ( 24)



No cassette is loaded, or it is set for erasure prevention ( 14, 15).



Fast forward playback ( 25)



Rewind playback ( 25)



Frame advance playback ( 26)



Frame reverse playback ( 26)



Remaining tape (Green: more than five minutes. Yellow: less than five minutes. Red: final few seconds.)



Playback pause (forward and reverse) ( 25)

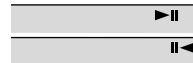

...finally, it tells you when you have completely run out of tape.



Slow playback (forward and reverse) ( 26)

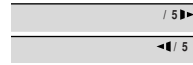

The camera is ejecting the tape ( 14).



×2 playback (forward and reverse) ( 26)



The safety mechanism is activated. Unload the cassette and turn the camera off. Turn it on again and reload the cassette.



×1 playback (forward and reverse) ( 26)



Recording mode ( 18)

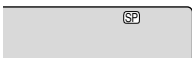
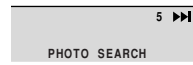
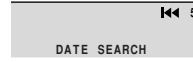

Photo Search ( 78)



Date Search ( 78)



Playback is stopped ( 24).



Zero set memory (forward and reverse) ( 79)

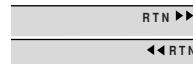

Normal playback ( 24)



A/V Insert Editing ( 85)



Audio Dubbing ( 88)

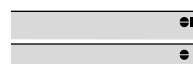

Additional Information

**E**

Zoom display ( 20):  
Optical zoom

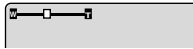

Optical plus 40x  
digital zoom

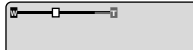

Zoom in



Zoom out



The image stabilizer is  
turned on ( 33).



CAM. MENU  
( 36)

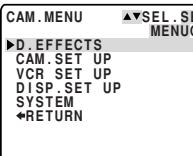

VCR MENU ( 37)

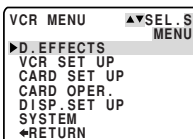

C. REC MENU  
( 39)  
(ELURA2 MC only)

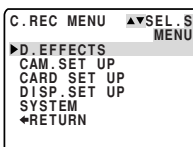

C. PLAY MENU  
( 40)  
(ELURA2 MC only)

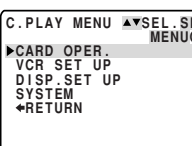

The remote sensor is  
turned off ( 43).



Self-timer countdown  
( 67)

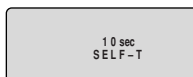

Zero set memory  
( 79)

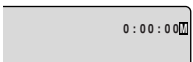

Audio mode ( 65)



Data code ( 75)



Photo mode ( 49)



Progressive scan  
mode ( 48)



- Setting the AF/AE. mark flashes white



- AF/AE locked. mark lights up green



- Timer

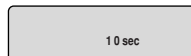

Recording programs  
( 53).

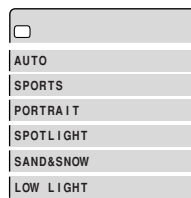

Manual exposure  
display ( 69):  
Exposure locked



Brighter than standard  
exposure level

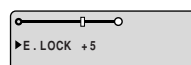

Darker than standard  
exposure level

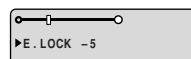

Manual focus is  
selected ( 72).

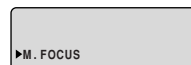

Shutter speed ( 70)



Additional Information

White balance is ( 73)

- Set
- Indoor
- Outdoor

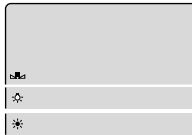

The 16:9 mode: the display flashes when the effect is being selected, and appears steadily when it is activated ( 18).



Digital effects. The display flashes when the function is being selected and appears steadily when it is activated ( 57).

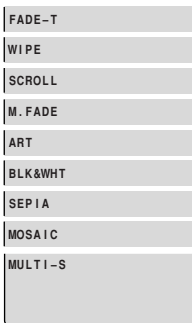

The wind screen is turned off ( 66).

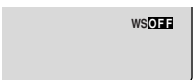

Volume level ( 27)

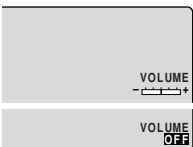

Audio output ( 91)



Mix balance ( 91)

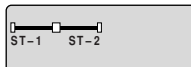

Audio/visual insert ( 85)



Audio dubbing ( 88)



Audio input ( 88)



Microphone input ( 88)



DV input ( 81, 100)



Condensation warning ( 123)



### MultiMediaCard Displays (ELURA2 MC only)

No MultiMediaCard is inserted ( 94).



Image quality ( 94):  
Standard



Fine



Folder number-File number ( 96).



Slide show in progress ( 102).

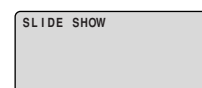

Recording to a MultiMediaCard ( 97).

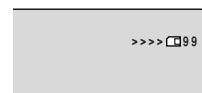

Additional Information

**E**

The number of still images that can still be recorded on the MultiMediaCard ( 97).  
 (Green: 6 or more images.  
 Yellow: Between 1 and 5 images  
 Red: No more images)



Accessing a MultiMediaCard ( 93).



Current still image/Total number of still images on the MultiMediaCard ( 97).

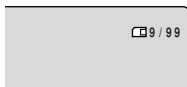

Protect mark ( 103).

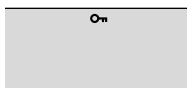

Card mix ( 106).



Print mark ( 111).



Data code ( 75).



### Time Code

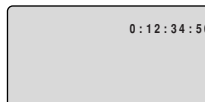

This records counter information, including hour, minute, second, and frame number on a special data code area on the tape itself. It is reset automatically when a new tape is loaded. In camera mode, the frame number doesn't appear in the display.

### Recording reminder

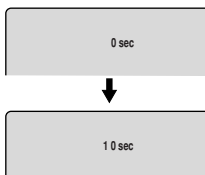

When you start recording, the camera counts from 0SEC to 10SEC. Shots which are shorter than ten seconds may be difficult to edit later. On the other hand, if you are not planning to edit the recording, remember that a shot which does not contain action should generally last no longer than 10 seconds.

**Additional Information**



## Caution phrases

E

The camera displays various caution phrases — they appear for 4 seconds before disappearing.

Appears each time you turn the power on, until you set the time zone, date and time (  45).

SET THE TIME ZONE,  
DATE AND TIME

Appears as a warning to protect the cassette and also when condensation is detected. Remove the cassette as soon as possible after the camera has displayed the caution.

REMOVE THE CASSETTE

Refer to p. 82

Appears when the battery pack is exhausted (  12, 117).

CHANGE THE BATTERY PACK

COPYRIGHT PROTECTED  
PLAYBACK IS RESTRICTED

Refer to p. 82

Appears when the tape has reached the end.

TAPE END

COPYRIGHT PROTECTED  
DUBBING RESTRICTED

Refer to p.15

THE TAPE IS SET FOR  
ERASURE PREVENTION

Appears when you try to do audio dubbing or A/V insert on a tape recorded in LP mode(  85, 88).

CHECK THE CASSETTE  
[REC MODE]

Appears if you press the REC PAUSE button when the DV cable is not connected properly (  81).

CHECK THE DV INPUT

Appears when you try to do audio dubbing on a tape recorded in 16-bit audio or 12-bit, 4-channel mode (  88-90).

CHECK THE CASSETTE  
[AUDIO MODE]

Refer to p. 123

CONDENSATION  
HAS BEEN DETECTED

Appears when the camera detects a blank section of a tape during audio dubbing or A/V insert (  85, 88).

CHECK THE CASSETTE  
[BLANK]

Additional  
Information

**E**



Appears when the video heads are badly contaminated (  121).

HEADS DIRTY,  
USE CLEANING CASSETTE

Appears if you have tried to mark 51 or more images for printing, or if a mark file cannot be edited. (  111)

PRINT MARK ERROR

### For ELURA MC

An error has occurred with the MultiMediaCard. The camera can not record or play back. A temporary card error is also possible. If **CARD ERROR** disappears after 4 seconds and  flashes red, format the MultiMediaCard. If  flashes green, playback is possible.

CARD ERROR

A MultiMediaCard has not been inserted into the camera. (  94)

NO CARD

There are no images recorded on the MultiMediaCard.

NO IMAGES

There is no more remaining memory on the MultiMediaCard. Change the card or erase images.

CARD FULL

You have reached the maximum file or folder number. (  96)

NAMING ERROR

**Additional  
Information**

The image has been recorded in an incompatible JPEG format or other format that the camera can not play back, or the image data has been damaged.

UNIDENTIFIABLE  
IMAGE

## Specifications

### ELURA2/ELURA2 MC

E

**Power Supply (rated):** 7.4 V DC

**Power Consumption (while recording with the AF turned on):**

4.4 W (Using viewfinder),

5.4 W (Using LCD screen)

**Television system:**

EIA standard (525 lines, 60 fields) NTSC color signal

**Video recording system:**

2 rotary heads, helical scanning

DV system (Consumer digital VCR SD system)

Digital component recording

**Audio recording system:** PCM digital

sound: 16 bit (48kHz/2ch),

12 bit (32kHz/4ch)

**Image sensor:** 1/4" Progressive Scan CCD (charge coupled device), approx. 680,000 pixels (approx. 360,000 effective pixels)

**Tape format:** Videocassettes bearing the Mini DV mark.

**Tape speed:**

SP: 3/4 ips (18.81 mm/s);

LP: 1/2 ips (12.56 mm/s)

**Maximum recording time:**

SP: 80 min. (with an 80 min. cassette);

LP: 120 min. (with an 80 min. cassette)

**Fast forward/rewind time:**

Approx. 2 min. 20 sec. (with a 60 min. cassette)

**Lens:** F/1.6–2.6, 10× power zoom, 3.5–35.0 mm

**Focusing system:** TTL autofocus, manual focusing possible

**Minimum focusing distance:** 3ft 3<sup>3</sup>/<sub>8</sub> in (1 m) (3<sup>3</sup>/<sub>8</sub> in (1 cm) on maximum wide angle)

**Maximum shutter speed:**

1/2,000 sec.

**Minimum illumination:** 7.5 lx (using the

Low light program)

**Recommended illumination:**

More than 100 lx

**Filter diameter:** 27 mm

**Viewfinder:** 0.44 in, TFT color LCD, approx. 113,000 pixels

**LCD screen:** 2.5 in measured diagonally, TFT color, approx. 200,000 pixels

**Microphone:** Stereo electret condenser microphone

**DV terminal input/output:**

Special 4-pin connector (conforms to IEEE1394)

**A/V terminal input/output:** ø 3.5 mm

Audio input: –10dBV/ at least 47 kohms, (L, R), unbalanced

output: –10dBV (47 kohm load)/ less than 3 kohms, unbalanced

Video: 1 Vp-p/75 ohms unbalanced

**S-video terminal input/output\*:**

1 Vp-p (Y signal), 0.286 Vp-p (C signal)

**MIC terminal input\*:** ø 3.5 mm stereo minijack, – 57 dBV (with 600 ohm mic)/ at least 5 kohms

**Headphone terminal\*:** ø 3.5 mm stereo minijack

**LANC terminal\*:** ø 2.5 mm mini minijack

**Operating temperature range:** 32–104 °F (0–40 °C)

**Dimensions:** 17<sup>7</sup>/<sub>8</sub> × 4<sup>1</sup>/<sub>8</sub> × 3<sup>3</sup>/<sub>8</sub> in (48 × 106 × 86 mm)

**Weight:** 13 3/4 oz (390 g)

### BP-406 Battery Pack

**Battery type:** Rechargeable lithium ion battery

**Rated voltage:** 7.4 V DC

**Operating temperature:** 32°–104°F (0°–40°C)

**Battery capacity:** 680 mAh

**Dimensions:** 17<sup>7</sup>/<sub>8</sub> × 2<sup>3</sup>/<sub>8</sub> × 3<sup>3</sup>/<sub>8</sub> in (49 × 60 × 11 mm)

**Weight:** 2<sup>1</sup>/<sub>2</sub> oz (70 g)

\*Attach the DU-300 Docking Unit

Weight and dimensions are approximate. Errors and omissions excepted. Subject to change without notice.

Canon is a trademark of Canon Inc.

Additional Information

## Index

### E

16:9, 18

### A

Abroad, Using the Camera, 122  
 Accessories, 6, 129  
 Adapter, AC, 11, 13  
 AE Programs, 53  
 Analog line-in, 83  
 Art, 60  
 Audio Dubbing, 88  
 Audio Mix, 91  
 Audio Mode, 65  
 Audio Output, 92  
 Audio Recording and Playback,  
     27, 65  
 Audio/Video Terminal, 30  
 Auto, 55  
 Autofocus, 72  
 A/V Insert, 85

### B

Backup Battery, 119  
 Basic Recording, 16  
 Battery Charger, 12  
 Battery Pack, 12, 117  
 Beep, 19  
 Black and White, 60

### C

Cables, 6, 28  
 Cassettes, 14  
 Charging the Battery Pack,  
     12-13, 117  
 Choosing a Recording Program, 53  
 Cleaning the Camera, 121  
 Clock, 47  
 Combining Images\*, 106  
 Condensation, 123  
 Connection to TV or VCR, 28  
 Copying from Cassette to  
     MultiMediaCard\*, 109  
 Copying from MultiMediaCard to  
     Cassette\*, 110

### D

Data Code, 75  
 Date and Time, 45  
 Date Search, 78  
 Digital Effects, 57  
 Digital Motor Drive, 48  
 Digital Video, 7  
 Digital Zoom, 20  
 Docking Unit, 28  
 DV Dubbing, 81, 100

### E

Easy Recording, 55  
 Editing to a VCR, 80  
 Effects, 60  
 Erasing Still Images from a  
     MultiMediaCard\*, 104  
 Exposure, 69  
 External Microphone, 65, 88

### F

Fade Trigger, 59  
 Faders, 59  
 Fast Forward, 24  
 Feedback, 30  
 File Numbers\*, 96  
 Finding Your Way Around the  
     ELURA2/ELURA2 MC, 8  
 Floppy Disk Still Image Recorder, 51  
 Focusing, 72  
 Formatting a MultiMediaCard\*,  
     112

### H

Head Cleaning, 121  
 Headphones, 65

### I

Image Stabilizer, 33  
 Image Quality\*, 94  
 Index\*, 102  
 Introducing the ELURA2/ELURA2  
     MC, 7

\* ELURA2 MC only

**L**

LANC, 80  
 LCD Screen, 21  
 Lens Cap, 116  
 Loading Cassettes, 14  
 Lock lever, 9, 19  
 Low Light, 56  
 LP Mode, 18

**M**

Maintenance, 120  
 Making Better Videos, 31  
 Manual Exposure Control, 69  
 Manual Focus, 72  
 Menus, 34  
 Microphone, 65, 88  
 Monitor Recording, 23  
 Mosaic, 59, 60  
 Mosaic Fade, 59  
 Multi-Image Screen, 63  
 MultiMediaCard Introduction\*, 93

**O**

Optional Accessories, 129

**P**

Pause, Record, 16  
 Photo Search, 78  
 Playback, 24  
 Playback Connection, 28  
 Playback Pause, 25  
 Portrait, 55  
 Power Adapter, 11, 13  
 Powering Your Camcorder, 11  
 Pre-Marked Position, 79  
 Preparing the Camera, 116  
 Preventing Accidental Erasure\*,  
 103  
 Print Mark\*, 111  
 Problems, 124  
 Progressive Scan, 48  
 Protect\*, 103

**R**

Recharging the Battery Pack, 118  
 Recording, 16, 97  
 Recording from Cassette to  
 MultiMediaCard\*, 99  
 Recording from DV Device to  
 MultiMediaCard\*, 100  
 Recording Programs, 53  
 Record Pause Mode, 16  
 Record Review, 52  
 Record Search, 52  
 Remote Control, 42  
 Remote Sensor, 43  
 Rewind, 24

**S**

S1 video input terminal, 29  
 Sample images, 114  
 Sand & Snow, 56  
 Screen Displays, 132  
 Scroll, 59  
 Self-Timer, 67  
 Sepia, 60  
 Shutter Sound\*, 96  
 Shutter Speed, 70  
 Slide Show\*, 102  
 Speaker, 27  
 Specifications, 115, 139  
 SP Mode, 18  
 Sports, 55  
 Spotlight, 56  
 Still Picture, 49, 97  
 Storage, 121  
 S-video, 29  
 System Diagram, 128

**T**

Tally Lamp, 42  
 Tape Protection, 15  
 Telephoto, 20  
 Temperature, 119, 121  
 Time Code, 136  
 Time Zone, 45

**E**

**Additional  
 Information**

\* ELURA2 MC only

**E**

Tips for Making Better Videos, 31  
Tripod, 31  
Troubleshooting, 124  
TV, 28, 132

**U**

Using the Camera Abroad, 122  
Using the Menus, 34

**V**

VCR, 28  
Videocassettes, 14  
Video Heads, 121  
Video ID-1 system, 29  
Viewfinder, 116, 121  
Viewing Still Images\*, 101

**W**

White Balance, 73  
Wide-angle, 20  
Widescreen TV, 18  
Wind Screen, 66  
Wipe, 59  
Wireless Controller, 42

**Z**

Zero Set Memory, 79  
Zooming, 20

**Additional  
Information**

## Menu at a Glance

Use the list below to quickly navigate the camera's menu. Functions are listed alphabetically.

E

Function	First make sure the POWER dial is set to...					Then select it from this submenu and set.
16:9 effect	MOVIE	P.SCAN				CAM.SET UP
6-sec. Date			VCR			DISP.SET UP
Audio dub			VCR			VCR SET UP
Audio mode	MOVIE	P.SCAN	VCR			VCR SET UP
Beep	MOVIE	P.SCAN	VCR	CARD REC	CARD PLAY	SYSTEM
Brightness	MOVIE	P.SCAN	VCR	CARD REC	CARD PLAY	DISP.SET UP
Card mix*	MOVIE	P.SCAN				D.EFFECTS → D.E.SELECT → CARD MIX
Copy- card to cassette*					CARD PLAY	CARD OPER.
Copy- cassette to card*			VCR			CARD OPER.
Data code			VCR			DISP.SET UP
Date/time display	MOVIE	P.SCAN		CARD REC		DISP.SET UP
Date/time select			VCR		CARD PLAY	DISP.SET UP
Date/time set	MOVIE	P.SCAN		CARD REC		SYSTEM
Digital effect select	MOVIE	P.SCAN	VCR	CARD REC		D.EFFECTS
Displays			VCR		CARD PLAY	DISP.SET UP
Effect	MOVIE	P.SCAN	VCR	CARD REC		D.EFFECTS → D.E.SELECT → EFFECT
Erase*					CARD PLAY	CARD OPER.
Fader	MOVIE	P.SCAN	VCR			D.EFFECTS → D.E.SELECT → FADER
File numbers*			VCR	CARD REC		CARD SET UP
Format*					CARD PLAY	CARD OPER.

\* ELURA2 MC only

Additional  
Information

**E**

Function	First make sure the POWER dial is set to...					Then select it from this submenu and set.
Image stabilizer	<b>MOVIE</b>	<b>P.SCAN</b>		<b>CARD REC</b>		CAM.SET UP
Index*					<b>CARD PLAY</b>	CARD OPER.
Multi-image screen speed	<b>MOVIE</b>	<b>P.SCAN</b>	<b>VCR</b>	<b>CARD REC</b>		D.EFFECTS → D.E.SELECT → MULTI-S
Multi-image screen split	<b>MOVIE</b>	<b>P.SCAN</b>	<b>VCR</b>	<b>CARD REC</b>		D.EFFECTS → D.E.SELECT → MULTI-S
Mirror mode	<b>MOVIE</b>	<b>P.SCAN</b>		<b>CARD REC</b>		DISP.SET UP
Mix type*	<b>MOVIE</b>	<b>P.SCAN</b>				D.EFFECTS → D.E.SELECT → CARD MIX → CARD MIX
Mix level*	<b>MOVIE</b>	<b>P.SCAN</b>				D.EFFECTS → D.E.SELECT → CARD MIX → CARD MIX
Output channel			<b>VCR</b>			VCR SET UP
Print mark*					<b>CARD PLAY</b>	CARD OPER.
Protect*					<b>CARD PLAY</b>	CARD OPER.
Quality*			<b>VCR</b>	<b>CARD REC</b>		CARD SET UP
Record mode	<b>MOVIE</b>	<b>P.SCAN</b>	<b>VCR</b>		<b>CARD PLAY</b>	VCR SET UP
Remote sensor code	<b>MOVIE</b>	<b>P.SCAN</b>	<b>VCR</b>	<b>CARD REC</b>	<b>CARD PLAY</b>	SYSTEM
Shutter speed	<b>MOVIE</b>	<b>P.SCAN</b>		<b>CARD REC</b>		CAM.SET UP
Shutter sound*				<b>CARD REC</b>		CARD SET UP
Tally lamp	<b>MOVIE</b>	<b>P.SCAN</b>				SYSTEM
Time zone/DST	<b>MOVIE</b>	<b>P.SCAN</b>		<b>CARD REC</b>		SYSTEM
TV screen	<b>MOVIE</b>	<b>P.SCAN</b>		<b>CARD REC</b>		DISP.SET UP
White balance	<b>MOVIE</b>	<b>P.SCAN</b>		<b>CARD REC</b>		CAM.SET UP
Wind screen	<b>MOVIE</b>	<b>P.SCAN</b>	<b>VCR</b>			VCR SET UP
Zoom	<b>MOVIE</b>	<b>P.SCAN</b>		<b>CARD REC</b>		CAM.SET UP

\* ELURA2 MC only



**U.S.A.**

## CANON® ELURA2/ELURA2 MC DIGITAL VIDEO CAMCORDER LIMITED WARRANTY

**E**

The limited warranty set forth below is given by Canon U.S.A., Inc. ("CUSA") with respect to each Canon ELURA2/ELURA2 MC Digital Video Camcorder ("DV Camcorder") purchased and used in the United States.

Each Canon DV Camcorder, when delivered to you in new condition in its original container, is warranted against defective material or workmanship as follows: for a period of one (1) year from the date of original purchase (three (3) months in the case of the video head part), defective parts or DV Camcorders returned to a CUSA factory service center ("CUSA Center") or an authorized DV Camcorder service facility ("Service Facility"), and proven to be defective upon inspection, will be repaired or exchanged for new or comparable rebuilt parts or DV Camcorders. The warranty period for repaired or replacement parts or DV Camcorders shall begin upon shipment of the same, but shall in no event exceed the original warranty period of the defective part or DV Camcorder.

**Non-Canon brand peripheral equipment and software which may be distributed with Canon DV Camcorders are sold "AS IS", without warranty of any kind by CUSA, including any implied warranty regarding merchantability or fitness for a particular purpose. The sole warranty with respect to such non-Canon brand items is given by the manufacturer or producer thereof.**

CUSA shall have no responsibility under this limited warranty for use of Canon DV Camcorders in conjunction with incompatible peripheral equipment and incompatible software.

In order to obtain warranty service, contact the authorized Canon retail dealer from whom you purchased the DV Camcorder or call the CANON INFORMATION CENTER AT 1-800-828-4040 (which is open from 9:00 a.m. to 5:00 p.m. (E.S.T.), Monday through Friday, excluding holidays). Have your unit serial number and your date of purchase available when you make the call to expedite service. In either case you will be directed to ship the DV Camcorder, postage prepaid, to the CUSA Center or Service Facility nearest to you. You must include a copy of the proof of purchase (bill of sale) and a complete explanation of the problem. DV Camcorders covered by this limited warranty will be repaired and returned to you without charge by the CUSA Center or the Service Facility. Repairs not under warranty will be at such cost as the CUSA Center or Service Facility may from time to time generally establish.

This limited warranty covers all defects encountered in normal use of the DV Camcorder, and does not apply in the following cases:

- (a) Loss of or damage to the DV Camcorder due to abuse, mishandling, improper packaging by you, alteration, accident, leaking batteries, exterior nicks, scratches or dents, electrical current fluctuations, failure to follow operating instructions, maintenance and environmental instructions prescribed in CUSA's instruction manual, or service performed by other than a CUSA Center or Service Facility.
- (b) Use of parts or supplies (other than those sold by CUSA) which cause damage to the DV Camcorder or cause abnormally frequent service calls or service problems.
- (c) If any DV Camcorder has had its serial number or dating altered or removed.

This limited warranty does not apply to accessories or consumables for the DV Camcorder, which are sold "AS IS", without warranty of any kind by CUSA.

**NO IMPLIED WARRANTY, INCLUDING ANY IMPLIED WARRANTY OF MERCHANTABILITY OR FITNESS FOR A PARTICULAR PURPOSE, APPLIES TO THE DV CAMCORDER AFTER THE APPLICABLE PERIOD OF EXPRESS WARRANTY STATED ABOVE, AND NO OTHER EXPRESS WARRANTY OR GUARANTY, EXCEPT AS MENTIONED ABOVE, GIVEN BY ANY PERSON, FIRM OR CORPORATION WITH RESPECT TO THE DV CAMCORDER SHALL BIND CUSA. (SOME STATES DO NOT ALLOW LIMITATIONS ON HOW LONG AN IMPLIED WARRANTY LASTS, SO THE ABOVE LIMITATION MAY NOT APPLY TO YOU) CUSA SHALL NOT BE LIABLE FOR LOSS OF REVENUES OR PROFITS, EXPENSE FOR SUBSTITUTE EQUIPMENT OR SERVICE, STORAGE CHARGES, LOSS OF DATA, OR ANY OTHER SPECIAL, INCIDENTAL OR CONSEQUENTIAL DAMAGES CAUSED BY THE USE, MISUSE OR INABILITY TO USE THE DV CAMCORDER, REGARDLESS OF THE LEGAL THEORY ON WHICH THE CLAIM IS BASED, AND EVEN IF CUSA HAS BEEN ADVISED OF THE POSSIBILITY OF SUCH DAMAGES. NOR SHALL RECOVERY OF ANY KIND AGAINST CUSA BE GREATER IN AMOUNT THAN THE PURCHASE PRICE OF THE DV CAMCORDER SOLD BY CUSA AND CAUSING THE ALLEGED DAMAGE. WITHOUT LIMITING THE FOREGOING, YOU ASSUME ALL RISK AND LIABILITY FOR LOSS, DAMAGE OR INJURY TO YOU AND YOUR PROPERTY AND TO OTHERS AND THEIR PROPERTY ARISING OUT OF USE, MISUSE OR INABILITY TO USE THE DV CAMCORDER NOT CAUSED DIRECTLY BY THE NEGLIGENCE OF CUSA. (SOME STATES DO NOT ALLOW THE EXCLUSION OR LIMITATION OF INCIDENTAL OR CONSEQUENTIAL DAMAGES, SO THE ABOVE LIMITATION MAY NOT APPLY TO YOU.) THIS LIMITED WARRANTY SHALL NOT EXTEND TO ANYONE OTHER THAN THE ORIGINAL PURCHASER OF ANY DV CAMCORDER, OR THE PERSON FOR WHOM IT WAS PURCHASED AS A GIFT, AND STATES YOUR EXCLUSIVE REMEDY.**

This limited warranty gives you specific legal rights, and you may also have other rights which vary from state to state.

**Canon U.S.A., Inc.**  
One Canon Plaza  
Lake Success, New York 11042

**Additional  
Information**

**145**

**CANADA****E****CANON CONSUMER DIGITAL VIDEO EQUIPMENT LIMITED WARRANTY**

The limited warranty set forth below is given by Canon Canada Inc. ("Canon Canada") with respect to Canon digital video equipment purchased in Canada. This limited warranty is only effective upon presentation of a bill of sale or other proof of purchase for this Canon digital video equipment to a Canon Service Facility when repairs are required.

Canon consumer video digital equipment is warranted under normal, non-commercial, personal use, against defective materials or workmanship as follows:

Parts: Defective parts will be exchanged for new parts or, at Canon Canada's option, comparable rebuilt parts for a period of one year from the date of original purchase, except Video Heads which will be exchanged for a period of 3 months from the date of purchase.

Labour: For a period of one year from the date of original purchase, labour will be provided free of charge by our Canon Service Facilities in Canada.

This limited warranty covers all defects except where:

- (a) The loss or damage to the product results from:
    - i) accident, natural disaster, mishandling, abuse, neglect, unauthorized product modification or failure to follow instructions contained in the instruction manual;
    - ii) the use of accessories, attachments, products, supplies, parts or devices with this Canon product that do not conform to Canon specifications or that cause abnormally frequent service problems;
    - iii) repairs or services performed by any party other than a Canon Service Facility;
    - iv) defective batteries or any exposure to water, sand or dirt;
    - v) shipping (claim must be presented to the shipper);
  - (b) Any serial number on the video equipment is altered or removed.
  - (c) The digital video equipment is used for commercial, professional or industrial purposes.
- This limited warranty does not cover the cabinet (exterior finish) of the digital video equipment, video cassette tapes, head cleanings, nor does it apply to digital video equipment purchased outside Canada.

**TO OBTAIN WARRANTY SERVICE**

Ship your Canon digital video equipment in its original carton, box or equivalent, properly packed, fully insured with shipping charges prepaid, together with a copy of your bill of sale or other proof of purchase and a description of the problem to any of the Canon Service Facilities in Canada.

**LIMITATIONS**

Except as otherwise required by applicable legislation, this warranty is in lieu of all other warranties, conditions, guarantees or representations, express or implied, statutory or otherwise, relative to this Canon product, including implied warranties or conditions of merchantability or fitness for a particular purpose.

Canon Canada assumes no liability for special, consequential or incidental damages or loss that may arise, whether on account of negligence or otherwise, from the use, misuse or inability to use this Canon product (including loss of profit, revenue, video tapes or enjoyment) or from failure to conform to any express or implied warranties, conditions, guarantees or representations. Any recovery under this limited warranty shall not exceed the purchase price of the product. Canon Canada does not assume or authorize any other person to assume for Canon Canada any other liability with respect to this Canon product.

This warranty does not extend to any person other than the original purchaser of this Canon product or the person for whom it was purchased as a gift and states your exclusive remedy.

**NOTICE TO CONSUMER**

If you plan to take important videos or if the product has not been used for some time, please check all functions with the instruction book before using it.

**Additional  
Information**

# Canon

## CANON INC.

**U.S.A.** ————— **CANON U.S.A., INC. NEW JERSEY OFFICE**  
100 Jamesburg Road, Jamesburg, NJ 08831 USA

**CANON U.S.A., INC. CHICAGO OFFICE**  
100 Park Blvd., Itasca, IL 60143 USA

**CANON U.S.A., INC. LOS ANGELES OFFICE**  
15955 Alton Parkway, Irvine, CA 92718 USA

**CANON U.S.A., INC. HONOLULU OFFICE**  
1020 Auahi Street, Bldg. #8, Honolulu, HI 96814 USA

- **If you have any questions, call the Canon U.S.A. Information Center toll-free at 1-800-828-4040 (U.S.A. only).**

**CANADA** ————— **CANON CANADA INC. NATIONAL HEADQUARTERS**  
6390 Dixie Road, Mississauga, Ontario L5T 1P7

**CANON CANADA INC. CALGARY**  
2828, 16th Street, N.E. Calgary, Alberta T2E 7K7

**CANON CANADA INC. MONTREAL**  
5990 Côte de Liesse, Quebec H4T 1V7

- **If you have any questions, call the Canon Canada Information Center toll-free at 1-800-828-4040. (Canada only)**

- **Si vous avez des questions, veuillez téléphoner sans frais au Canada 1-800-828-4040. (Canada seulement)**

**MEXICO** ————— **CANON MEXICANA, S. DE R.L. DE C.V.**  
Periferico Sur No. 4124 Col. Ex-Rancho de Anzaldo C.P. 01900  
México, D.F., México

**CENTRO Y SURAMÉRICA** ————— **CANON LATIN AMERICA, INC.**  
6505 Blue Lagoon Drive Suite 325 Miami FL 33126 USA

**ASIA** ————— **CANON HONGKONG COMPANY LTD.**  
9/F, The Hong Kong Club Building, 3A Chater Road, Central, Hong Kong



Printed on 70% reused paper.  
Document réalisé avec du papier recyclé à 70%.  
El papel aquí utilizado es 70% reciclado.

PUB.DIM-352B  
0800A/AB3.5

© CANON INC. 2000  
DY8-9120-247-000

PRINTED IN JAPAN  
IMPRIME AU JAPON  
IMPRESO EN JAPÓN

## Free Manuals Download Website

<http://myh66.com>

<http://usermanuals.us>

<http://www.somanuals.com>

<http://www.4manuals.cc>

<http://www.manual-lib.com>

<http://www.404manual.com>

<http://www.luxmanual.com>

<http://aubethermostatmanual.com>

Golf course search by state

<http://golfingnear.com>

Email search by domain

<http://emailbydomain.com>

Auto manuals search

<http://auto.somanuals.com>

TV manuals search

<http://tv.somanuals.com>