

## Digital Video Camcorder Instruction Manual

## Caméscope numérique Manuel d'instruction

## Videocámara digital Manual de Instrucciones

ZR950



Please read also the **Digital Video Software** instruction manual (on PDF file). Refer to the installation guide for further details.

Veuillez lire aussi le manuel d'instruction **Digital Video Software** (sur fichier PDF). Pour d'autres détails, référez-vous au guide d'installation.

Lea también el manual de instrucciones **Digital Video Software** (en archivo PDF). Para mayores detalles, refiérase a la guía de instalación.

English

Français

Español



NTSC



Mini DV Digital Video Cassette

## Cleaning the Video Heads

Digital video camcorders record video signals onto the tape in very thin lines (as thin as 1/8 the width of a hair). The following anomalies may appear if the video heads become dirty even a little.

- Mosaic or other blocky video artifacts (Fig. 1) or banding (Fig. 2) appear on the picture during playback.
- Sound becomes distorted, or there is no sound during playback.
- The message "HEADS DIRTY, USE CLEANING CASSETTE" appears.



Fig. 1

If such symptoms appear, clean the video heads with the Canon DVM-CL Digital Video Head Cleaning Cassette\* or a commercially available dry cleaning cassette.

If the symptoms reappear shortly after the cleaning, the videocassette may be defective. Stop using it.

\* Availability differs from area to area.



Fig. 2

### Video heads may become dirty under the following conditions:

- When using the camcorder in humid or hot places.
- When using cassettes with damaged or dirty tapes.
- When using the camcorder in dusty places.
- When using the video heads for a long time without cleaning them.

### NOTES

- Before you make important recordings, clean the video heads and make a test recording first. We also recommend cleaning the video heads after use, before storing the camcorder.
- Do not use wet type cleaning cassettes as this may damage the camcorder.
- Even after cleaning the video heads you may not be able to play back correctly tapes that were recorded with dirty video heads.

# Important Usage Instructions

## WARNING!



**TO REDUCE THE RISK OF FIRE OR ELECTRIC SHOCK, DO NOT EXPOSE THIS APPARATUS TO RAIN OR MOISTURE.**

For Canada only:

**TO REDUCE THE RISK OF ELECTRIC SHOCK, DO NOT EXPOSE THIS PRODUCT TO DRIPPING OR SPLASHING.**

## WARNING!



**TO REDUCE THE RISK OF ELECTRIC SHOCK AND TO REDUCE ANNOYING INTERFERENCE, USE THE RECOMMENDED ACCESSORIES ONLY.**

## COPYRIGHT WARNING:

**Unauthorized recording of copyrighted materials may infringe on the rights of copyright owners and be contrary to copyright laws.**

Digital Video Camcorder, ZR950 A systems

This device complies with Part 15 of the FCC Rules. Operation is subject to the following two conditions: (1) This device may not cause harmful interference, and (2) this device must accept any interference received, including interference that may cause undesired operation.

Note: This equipment has been tested and found to comply with the limits for class B digital device, pursuant to Part 15 of the FCC Rules. These limits are designed to provide reasonable protection against harmful interference in a residential installation. This equipment generates, uses and can radiate radio frequency energy and, if not installed and use in accordance with the instructions, may cause harmful interference to radio communications. However, there is no guarantee that interference will not occur in a particular installation. If this equipment does cause harmful interference to radio or television reception, which can be determined by turning the equipment off and on, the user is encouraged to try to correct the interference by one or more of the following measures:

- Reorient or relocate the receiving antenna.
- Increase the separation between the equipment and receiver.
- Connect the equipment into an outlet on a circuit different from that to which the receiver is connected.
- Consult the dealer or an experienced radio/TV technician for help.

Use of shielded cable is required to comply with class B limits in Subpart B of Part 15 of FCC Rules.

Do not make any changes or modifications to the equipment unless otherwise specified in the manual.

If such changes or modifications should be made, you could be required to stop operation of the equipment.

Canon U.S.A. Inc.

One Canon Plaza, Lake Success, NY 11042, U.S.A.

Tel No. (516)328-5600

## Important Warning



The lightning flash with arrowhead symbol, within an equilateral triangle, is intended to alert the user to the presence of uninsulated "dangerous voltage" within the product's enclosure, that may be of sufficient magnitude to constitute a risk of electric shock to persons.

## CAUTION:

**TO REDUCE THE RISK OF ELECTRIC SHOCK, DO NOT REMOVE COVER (OR BACK). NO USER-SERVICEABLE PARTS INSIDE. REFER SERVICING TO QUALIFIED SERVICE PERSONNEL.**



The exclamation point, within an equilateral triangle, is intended to alert the user to the presence of important operating and maintenance (servicing) instructions in the literature accompanying the product.

# IMPORTANT SAFETY INSTRUCTIONS

In these safety instructions the word "apparatus" or "product" refers to the Canon Digital Video Camcorder ZR950 A and all its accessories.

- 1** Read Instructions — All the safety and operating instructions should be read before the product is operated.
- 2** Retain Instructions — The safety and operating instructions should be retained for future reference.
- 3** Heed Warnings — All warnings on the product and in the operating instructions should be adhered to.
- 4** Follow Instructions — All operating and maintenance instructions should be followed.
- 5** Cleaning — Unplug this product from the wall outlet before cleaning. Do not use liquid or aerosol cleaners. The product should be cleaned only as recommended in this manual.
- 6** Accessories — Do not use accessories not recommended in this manual as they may be hazardous.
- 7** Avoid magnetic or electric fields — Do not use the camera close to TV transmitters, portable communication devices or other sources of electric or magnetic radiation. They may cause picture interference, or permanently damage the camera.
- 8** Water and Moisture — Hazard of electric shock — Do not use this product near water or in rainy/moist situations.
- 9** Placing or Moving — Do not place on an unstable cart, stand, tripod, bracket or table. The product may fall, causing serious injury to a child or adult, and serious damage to the product.

A product and cart combination should be moved with care. Quick stops, excessive force, and uneven surfaces may cause the product and cart combination to overturn.



- 10** Power Sources — The CA-590 Compact Power Adapter should be operated only from the type of power source indicated on the marking label. If you are not sure of the type of power supply to your home, consult your product dealer or local power company. Regarding other power sources such as battery power, refer to instructions in this manual.
- 11** Power Cord Protection — Power cords should be routed so that they are not likely to be walked on or pinched by items placed upon or against them. Pay particular attention to plugs and the point from which the cords exit the product.
- 12** Outdoor Antenna Grounding — If an outside antenna is connected to the product, be sure the antenna is grounded so as to provide some protection against voltage surges and built-up static charges. Section 810 of the National Electrical Code, ANSI / NFPA No. 70—1984, provides information with respect to proper grounding of the mast and supporting structure, grounding of the lead-in wire to an antenna discharge unit, size of grounding conductors, location of antenna discharge unit, connection to grounding electrodes, and requirements for the grounding electrode. See figure 1.

**Fig. 1** EXAMPLE OF ANTENNA GROUNDING AS PER NATIONAL ELECTRICAL CODE

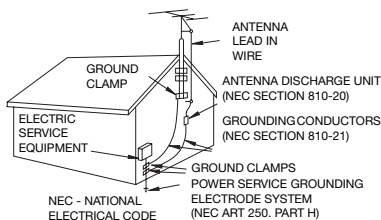

- 13** Lightning — For added protection of this product during a lightning storm, or when it is left unattended and unused for long periods of time, disconnect it from the wall outlet and disconnect the antenna. This will prevent damage to the product due to lightning and power-line surges.
- 14** Overloading — Do not overload wall outlets and extension cords as this can result in a risk of fire or electric shock.
- 15** Objects and Liquid Entry — Never push objects of any kind into this product through openings as they may touch dangerous voltage points or short out parts that could result in a fire or electric shock. Be careful not to spill liquid of any kind onto the product.
- 16** Servicing — Do not attempt to service this product yourself as opening or removing covers may expose you to dangerous voltage or other hazards. Refer all servicing to qualified service personnel.
- 17** Damage Requiring Service — Disconnect this product from the wall outlet and all power sources including battery, and refer servicing to qualified service personnel under the following conditions:
- When the power-supply cord or plug is damaged.
  - If any liquid has been spilled onto, or objects have fallen into, the product.
  - If the product has been exposed to rain or water.
- If the product does not operate normally even if you follow the operating instructions. Adjust only those controls that are covered by the operation instructions. Improper adjustment of other controls may result in damage and will often require extensive work by a qualified technician to restore the product to its normal operation.
  - If the product has been dropped or the cabinet has been damaged.
  - When the product exhibits a distinct change in performance. This indicates a need for service.
- 18** Replacement Parts — When replacement parts are required, be sure the service technician has used replacement parts that are specified by Canon or that have the same characteristics as the original part. Unauthorized substitutions may result in fire, electric shock or other hazards.
- 19** Safety Check — Upon completion of any service or repairs to this product, ask the service technician to perform safety checks to determine that the product is in safe operating order.

When replacement of the power supply is required, please return it to the responsible nearest Canon Service Center and please replace it with the same type number CA-590.

The adapter can be used with a power supply between 100 and 240 V AC. For areas where 120 V AC power is not used, you will need a special plug adapter. Contact your nearest Canon Service Center for further information. The adapter is not intended to be serviced. Should the product cease to function in its intended manner, it should be returned to the manufacturer or be discarded.

This Class B digital apparatus complies with Canadian ICES-003.

The Mains plug is used as the disconnect device. The Mains plug shall remain readily operable to disconnect the plug in case of an accident.

# Table of contents

## Introduction

---

- 10 About this Manual
- 11 Getting to Know the Camcorder**
- 11 Supplied Accessories
- 13 Components Guide
- 16 Screen Displays

## Preparations

---

- 19 Getting Started**
- 19 Charging the Battery Pack
- 21 Installing the Backup Battery
- 21 Preparing the Wireless Controller and Accessories
- 23 Basic Operation of the Camcorder**
- 23 Operating Modes
- 23 Joystick and Joystick Guide
- 24 Using the Menus
- 26 First Time Settings**
- 26 Changing the Language
- 26 Changing the Time Zone
- 27 Setting the Date and Time
- 27 Getting Ready to Start Recording**
- 27 Opening the Lens Cover and Adjusting the LCD Screen
- 29 Inserting and Removing a Tape
- 30 Inserting and Removing a Memory Card

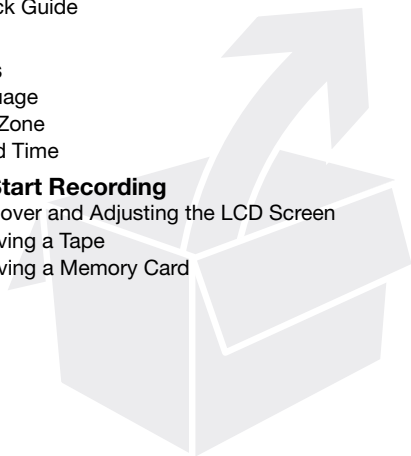

## Video

---



### **31 Basic Recording**

- 31 Shooting Video
- 33 Zooming: Optical, Advanced and Digital Zoom
- 34 Quick Start Function
- 35 Reviewing the Last Scene Recorded

### **36 Basic Playback**

- 36 Playing Back Video
- 37 Returning to a Pre-marked Position
- 38 Locating the Beginning of a Recording Date
- 38 Locating the End of the Last Scene
- 39 On-Screen Displays (Data Code)

### **40 Advanced Function**

- 40  Special Scene Recording Programs
- 42  Flexible Recording: Changing the Shutter Speed
- 43 LCD Video Light
- 43 Self Timer
- 44 Audio Recording Mode
- 44 Audio Playback Modes
- 45 Manual Focus Adjustment
- 46 Manual Exposure Adjustment
- 47 White Balance
- 48 Image Effects
- 48 Digital Effects

## Photos

---

### **50 Basic Recording**

- 50 Taking Photos
- 51 Selecting Photo Size and Quality
- 52 Erasing or Protecting a Photo Right After Recording It

### **52 Basic Playback**

- 52 Viewing Photos
- 53 Magnifying Photos during Playback
- 54 Erasing Photos

### **55 Additional Functions**

- 55 Automatic Focus Priority
- 55 Protecting Photos
- 56 Initializing the Memory Card

### **57 Printing Photos**

- 57 Printing Photos – Direct Print
- 57 Selecting the Print Settings
- 59 Print Orders

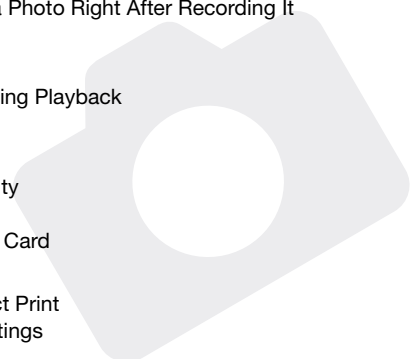

## External Connections

---

### **61 Connecting to a TV or VCR**

- 62 Connection Diagrams
- 63 Playback on a TV Screen
- 63 Copying your Recordings to an External Video Recorder
- 64 Digital Video Dubbing
- 66 Audio Dubbing

### **67 Connecting to a Computer**

- 67 PC Connection Diagrams
- 68 Transferring Video Recordings
- 69 Transferring Photos – Direct Transfer
- 71 Transfer Orders

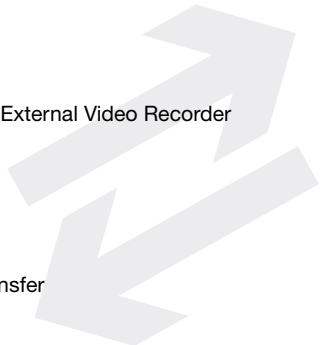



## Additional Information

---

### **72 Appendix: Menu Options Lists**

- 72 FUNC. Menu
- 73 Setup menus
  - 73 Camera Setup (Advanced Zoom, Image Stabilizer, etc.)
  - 74 VCR Setup (Recording Mode, TV Type, etc.)
  - 75 Audio Setup (Audio Mode, Wind Screen, etc.)
  - 76 Card Operations (Card Initialization, etc.)
  - 76 Display Setup (LCD Brightness, Language, etc.)
  - 77 System Setup (Beep, Power Save, etc.)
  - 78 Date/Time Setup

### **79 Trouble?**

- 79 Troubleshooting
- 82 List of Messages

### **86 Do's and Don'ts**

- 86 Handling Precautions
- 89 Maintenance/Others
- 90 Using the Camcorder Abroad

### **91 General Information**

- 91 System Diagram
- 92 Optional Accessories
- 95 Product Codes
- 96 Specifications
- 99 Index

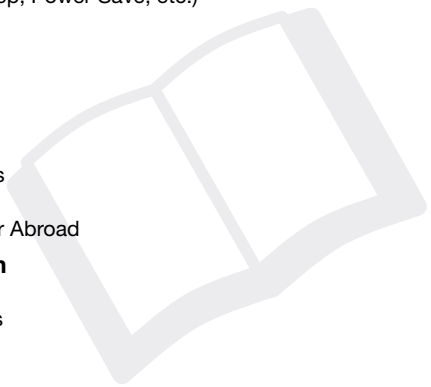

## About this Manual

Thank you for purchasing the Canon ZR950. Please read this manual carefully before you use the camcorder and retain it for future reference. Should your camcorder fail to operate correctly, refer to *Troubleshooting* (79).

### Conventions Used in this Manual

- **!** **IMPORTANT:** Precautions related to the camcorder's operation.
- **i** **NOTES:** Additional topics that complement the basic operating procedures.
- **✓** **POINTS TO CHECK:** Restrictions or requirements regarding the function described.
- **79** : Reference page number.
- "Screen" refers to the LCD and the viewfinder screen.
- The photos included in the manual are simulated pictures taken with a still camera.

Buttons and switches to be operated

Brackets [ ] and capital letters are used to refer to menu options as they are displayed on screen. In tables in this manual the default value is shown in boldface. For example **[ON]**, [OFF].

Names of buttons and switches other than the joystick are indicated within a "button" frame. For example **FUNC.**.

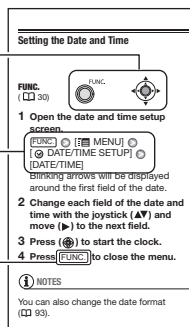

## Supplied Accessories

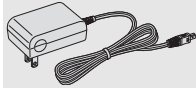

CA-590 Compact Power Adapter

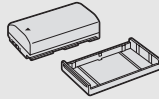

BP-2L5 Battery Pack

Lithium Button Battery  
(CR1616)



STV-250N Stereo Video Cable



WL-D85 Wireless Controller



Lithium Button Battery  
(CR2025) for Wireless  
Controller

IFC-300PCU USB Cable

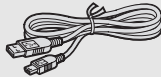

Software CD-ROM\*  
**DIGITAL VIDEO  
Solution Disk**

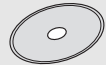

\* Includes the electronic version of the *Digital Video Software* instruction manual on PDF file.

**Online product registration for U.S.A. Customers only.**

Register your product online at [www.registercanon.com](http://www.registercanon.com)

✓ **Protect your product**

We will keep the model number and date of purchase of your new Canon product on file to help you refer to this information in the event of an insurance claim such as loss or theft.

✓ **Receive information on new products and promotions**

Upon your request, we will send you information on Canon new products and promotions.

The serial number of this product can be found at the battery attachment unit of the camcorder. Write down the number and other information here and retain this book as a permanent record of your purchase to aid identification in case of theft.

Date of Purchase:

Model Name: ZR950 A

Purchased From:

Serial No.:

Dealer Address:

Dealer Phone No.:

## Components Guide

### Left side view

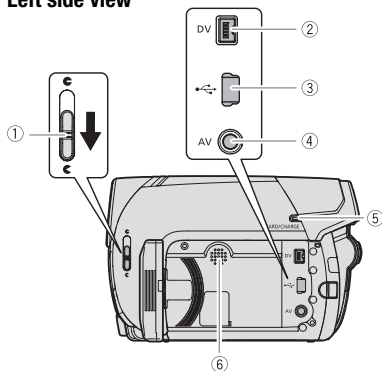

- ① Lens cover switch (□ 31, 50)  
(☞ open, ☹ closed)
- ② DV terminal (□ 62, 67)
- ③ USB terminal (□ 67)
- ④ AV terminal (□ 62)
- ⑤ CARD access indicator (□ 50)/  
CHARGE indicator (□ 19)
- ⑥ Speaker
- ⑦ Mode switch (□ 32)  
**EASY** Easy recording  
**P** Recording programs
- ⑧ / (tape/card) switch (□ 23)
- ⑨ Grip belt (□ 22)
- ⑩ Strap mount (□ 93)
- ⑪ Lock button
- ⑫ **POWER** switch (□ 23)
- ⑬ Stereo microphone

### Right side view

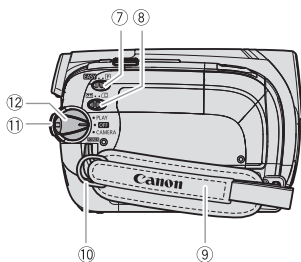

Names of buttons and switches other than the joystick are indicated within a "button" frame (for example ).

### Front view

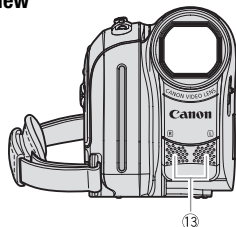

**Back view**

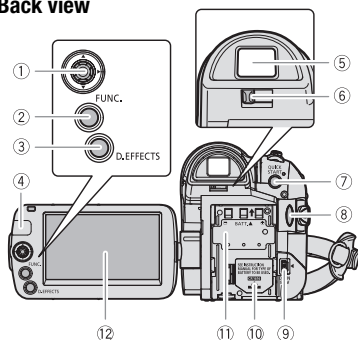

**Top view**

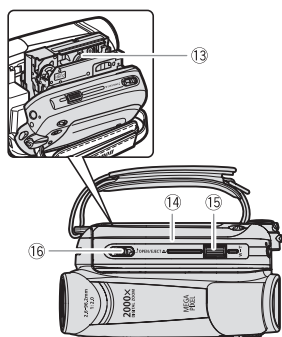

**Bottom view**

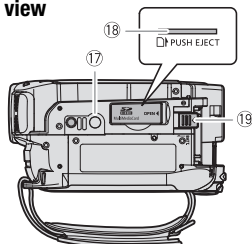

- ① Joystick (□ 23)
- ② FUNC. button (□ 24, 72)
- ③ D.EFFECTS button (□ 48)
- ④ Remote sensor (□ 22)
- ⑤ Viewfinder (□ 32)
- ⑥ Dioptic adjustment lever (□ 32)
- ⑦ QUICK START button (□ 34)
- ⑧ Start/Stop button (□ 31, 50)
- ⑨ DC IN terminal (□ 19)
- ⑩ Backup battery compartment (□ 21)
- ⑪ Serial number/  
Battery attachment unit (□ 19)
- ⑫ LCD screen (□ 27)
- ⑬ Cassette compartment (□ 29)
- ⑭ Cassette compartment cover (□ 29)
- ⑮ Zoom lever (□ 33)
- ⑯ OPEN/EJECT ▲ switch (□ 29)
- ⑰ Tripod socket (□ 22)
- ⑱ Memory card slot (□ 30)
- ⑲ BATT. (battery release) switch (□ 19)

Names of buttons and switches other than the joystick are indicated within a "button" frame (for example FUNC.).

## Wireless Controller WL-D85

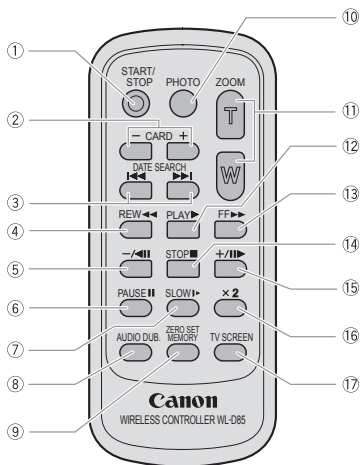

- ① START/STOP button (☐ 31)
- ② CARD -/+ buttons (☐ 52)
- ③ DATE SEARCH ◀◀/▶▶ buttons (☐ 38)
- ④ REW ◀◀ button (☐ 36)
- ⑤ -/◀ button (☐ 36)
- ⑥ PAUSE || button (☐ 36)
- ⑦ SLOW ▶▶ button (☐ 36)
- ⑧ AUDIO DUB. button (☐ 66)
- ⑨ ZERO SET MEMORY button (☐ 37)
- ⑩ PHOTO button (☐ 50)
- ⑪ Zoom buttons (☐ 33)
- ⑫ PLAY ▶▶ button (☐ 36)
- ⑬ FF ▶▶▶▶ button (☐ 36)
- ⑭ STOP ■ button (☐ 36)
- ⑮ +/▶▶▶▶ button (☐ 36)
- ⑯ x2 button (☐ 36)
- ⑰ TV SCREEN button (☐ 77)

## Screen Displays

### **CAMERA** Recording Movies

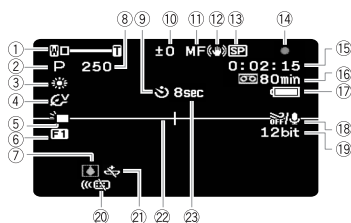

### **PLAY** Playing Movies

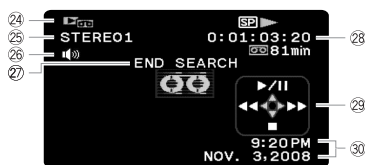

- ① Zoom (□ 33), Exposure  (□ 46)
- ② Recording program (□ 40)
- ③ White balance (□ 47)
- ④ Image effect (□ 48)
- ⑤ LCD video light (□ 43)
- ⑥ Digital effects (□ 48)
- ⑦ Condensation warning (□ 89)
- ⑧ Shutter speed (□ 42)
- ⑨ Self timer (□ 43)
- ⑩ Exposure adjustment (□ 46)
- ⑪ Manual focus (□ 45)
- ⑫ Image stabilizer (□ 74)
- ⑬ Recording mode (□ 75)
- ⑭ Tape operation (□ 18)
- ⑮ Time code (hours : minutes : seconds)
- ⑯ Remaining tape (□ 18)
- ⑰ Remaining battery charge (□ 18)
- ⑱ Wind screen off (□ 75)
- ⑲ Audio recording mode (□ 44)
- ⑳ Remote sensor off (□ 77)
- ㉑ Backup battery warning (□ 21)
- ㉒ Level marker (□ 77)
- ㉓ Recording reminder (□ 18)
- ㉔ Operating mode (□ 23)
- ㉕ Audio playback mode (□ 45)
- ㉖ Speaker volume (□ 36)
- ㉗ Search function display  
END SEARCH (□ 38)/  
DATE SEARCH (□ 38)
- ㉘ Playback time  
(hours : minutes : seconds : frames)
- ㉙ Joystick guide (□ 23)
- ㉚ Data code (□ 39)



## CAMERA Recording Still Images

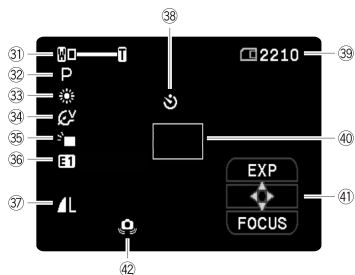

- 31 Zoom ([33](#)), Exposure  ( [46](#) )
- 32 Recording program ([40](#))
- 33 White balance ([47](#))
- 34 Image effect ([48](#))
- 35 LCD video light ([43](#))
- 36 Digital effects ([48](#))
- 37 Still image quality/size ([51](#))
- 38 Self timer ([43](#))
- 39 Number of still images available on the memory card ([18](#))
- 40 AF frame ([55](#))
- 41 Joystick guide ([23](#))
- 42 Camcorder shake warning ([74](#))
- 43 Slideshow ([53](#))
- 44 Image protection mark ([55](#))
- 45 Image number ([18](#), [78](#))
- 46 Current image /Total number of images
- 47 Still image size
- 48 Data code ([39](#))

## PLAY Viewing Still Images

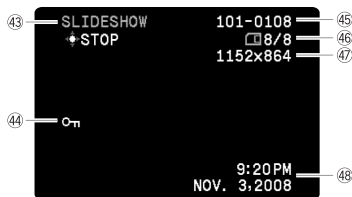



**14 Tape operation**

Note that some playback and search modes are only available when using the wireless controller.

- Record, ● Record pause,
- Stop, ▲ Eject,
- ▶▶ Fast forward, ◀◀ Rewind,
- ▶ Playback, ▶ Record Playback pause,
- ◀◀ Reverse playback pause,
- x1 ▶ Playback (normal speed),
- ◀x1 Reverse playback (normal speed),
- x2 ▶ Playback (double speed),
- ◀x2 Reverse playback (double speed),
- ▶▶ Fast forward playback,
- ◀◀ Rewind playback,
- ▶ Slow playback,
- ◀ Slow reverse playback,
- ▶ Frame advance,
- ◀ Frame reverse,
- ◀◀/▶▶ Date search ( 38),
- ◀◀ / ▶▶ Zero set memory ( 37)

**16 Remaining tape**

Indicates the remaining time of the tape in minutes.

 moves during recording. When the tape reaches its end, the display changes to " END".

- When the time left is less than 15 seconds, the remaining tape time may not appear.
- Depending on the type of tape, the remaining time displayed may not be correct. In any case, you will be able to record on the tape the number of minutes that appears on the cassette's label (for example, 85 minutes).

**17 Remaining battery charge**

- When  starts flashing in red replace the battery pack with a fully charged one.
- When you attach an empty battery pack, the power may turn off without displaying the icon.

- Depending on the conditions under which the camcorder and the battery pack are used, the actual battery charge may not be indicated accurately.

**23 Recording reminder**

The camcorder counts from 1 to 10 seconds when you start recording. This is helpful to avoid scenes that are too short.

**39 Number of still images available on the memory card**

 flashing in red: No card

 in green: 6 or more images

 in yellow: 1 to 5 images

 in red: No more images can be recorded

- When viewing the still images, the display will always be in green.
- Depending on the recording conditions, the number of available still images displayed may not decrease even after a recording has been made, or may decrease by 2 still images at once.

**Card Access Display**

▶  is displayed next to the number of images available while the camcorder is writing on the memory card.

**45 Image number**

The image number indicates the name and location of the file on the memory card. For example, the file name of image 101-0107 is "IMG\_0107.JPG", stored under the folder "DCIM\101CANON".



# Preparations

This chapter describes basic operations, such as navigating the menus, and first time settings to help you learn more about your camcorder.

## Getting Started

### Charging the Battery Pack

The camcorder can be powered with a battery pack or directly using the compact power adapter. Charge the battery pack before use.

For approximate charging times and recording/playback times with a full battery pack, refer to the tables on page 93.

Remove the battery terminal cover before attaching the battery

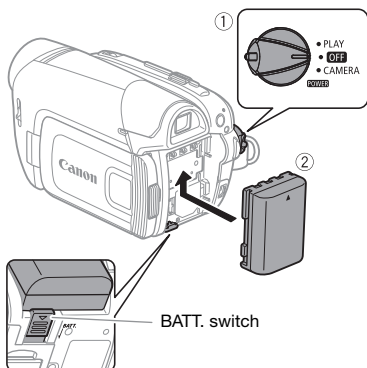
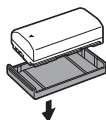

#### 1 Turn off the camcorder.

#### 2 Attach the battery pack to the camcorder.

Press the battery pack lightly and slide it up until it clicks.

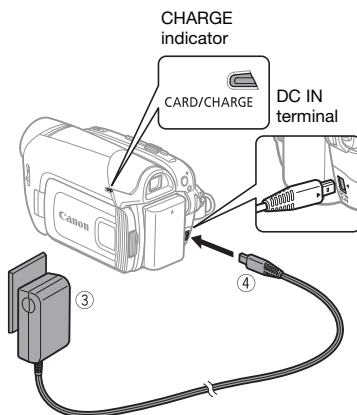

#### 3 Plug the compact power adapter into a power outlet.

#### 4 Connect the compact power adapter to the camcorder's DC IN terminal.

- The CHARGE indicator starts flashing. The indicator will stay on when the charging is completed.
- You can also use the compact power adapter without attaching a battery pack.
- When the compact power adapter is connected, even if a battery is

attached its power will not be consumed.

#### ONCE THE BATTERY IS FULLY CHARGED

- 1 **Disconnect the compact power adapter from the camcorder.**
- 2 **Unplug the compact power adapter from the power outlet.**

#### TO REMOVE THE BATTERY PACK

Press **BATT.** to release the battery pack. Slide the battery pack down and then pull it out.

#### ! IMPORTANT

- You may hear some noise from the compact power adapter during use. This is not a malfunction.
- We recommend charging the battery pack in temperatures between 10 °C and 30 °C (50 °F and 86 °F). Outside the temperature range of 0 °C to 40 °C (32 °F to 104 °F), charging will not start.
- Do not connect to the camcorder's DC IN terminal or to the compact power adapter any electrical equipment that is not expressly recommended for use with this camcorder.
- To prevent equipment breakdowns and excessive heating, do not connect the supplied compact power adapter to voltage converters for overseas travels or special power sources such as those on aircraft and ships, DC-AC inverters, etc.

#### i NOTES

- The CHARGE indicator also serves as a rough estimate of the battery charge status.  
Continuously on: Battery pack fully charged.  
Two quick flashes at 1-second intervals: Battery pack at least 50% charged. If the indicator flashes quickly but not exactly in this pattern, refer to *Troubleshooting* (□ 79).  
One flash at 1-second intervals: Battery pack less than 50% charged.
- We recommend that you prepare battery packs 2 to 3 times longer than you think you might need.
- **U.S.A. and Canada only:** The lithium ion/polymer battery that powers this product is recyclable. Please call 1-800-8-BATTERY for information on how to recycle this battery.



## Installing the Backup Battery

The backup battery (lithium button battery CR1616) allows the camcorder to retain the date, time (☐ 27) and other camcorder settings while the power source is disconnected. Connect a power source to the camcorder when replacing the backup battery to retain the settings.

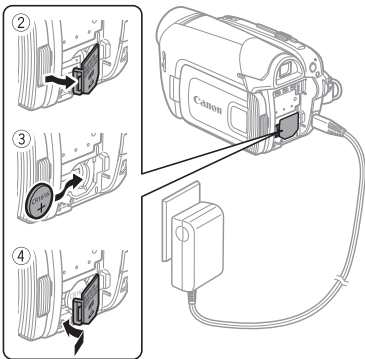

- 1 If a battery pack is attached, remove it first.
- 2 Open the backup battery cover.
- 3 Insert the backup battery with the + side facing out.

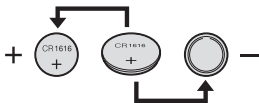

- 4 Close the cover.

## **i** NOTES

The battery life of the backup battery is about one year. flashes in red when the lithium button battery is not installed, or when it needs to be replaced.

## Preparing the Wireless Controller and Accessories

First, insert the supplied lithium button battery (CR2025) into the wireless controller.

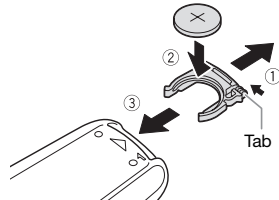

- 1 Press the tab in the direction of the arrow and pull out the battery holder.
- 2 Place the lithium button battery with the + side facing up.
- 3 Insert the battery holder.

## TO USE THE WIRELESS CONTROLLER

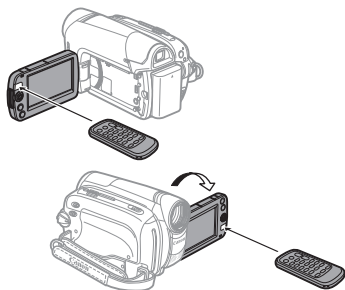

### Point the controller at the camcorder's remote sensor when you press the buttons.

You can rotate the LCD panel 180 degrees to use the wireless controller from the front of the camcorder.

## **i** NOTES

- The wireless controller may not work properly when the remote sensor is situated under strong light sources or direct sunlight.
- If the wireless controller does not work, check that [WL.REMOTE] is not set to [OFF] (OFF) (77). Otherwise, replace the battery.

## Accessories

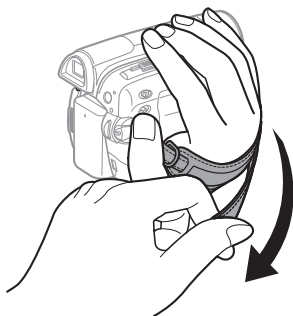

### Fasten the grip belt.

Adjust the grip belt so that you can reach the zoom lever with your index finger, and the [Start/Stop] button with your thumb.

## WHEN YOU MOUNT THE CAMCORDER ON A TRIPOD

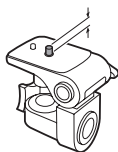

Do not leave the viewfinder exposed to direct sunlight as it may melt (due to concentration of the light by the lens). Do not use tripods with fastening screws longer than 5.5 mm (0.2 in.). Doing so may damage the camcorder.



## Basic Operation of the Camcorder

### Operating Modes

The camcorder's operating mode is determined by the positions of the **POWER** switch and the / switch. In the manual, indicates that a function is available in the operating mode shown and indicates that the function is not available. When no operating mode icons are given, the function is available in all operating modes.

### Joystick and Joystick Guide

Use the joystick to operate the camcorder's menus.

Push the joystick up, down, left or right (, , , ) to select an item or change settings.

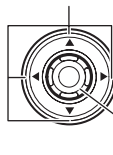

Press the joystick itself () to save the settings or confirm an action. On menu screens, this is indicated by the icon



The joystick can also be used in combination with the joystick guide to operate additional functions. Press () to display/hide the joystick guide (when recording, the joystick guide will appear only when the mode switch is set to ). The functions that appear on the joystick guide will change depending on the operating mode.

Operating mode	POWER switch	/  switch	Icon display	Operation	
		(Tape)		Recording movies on a tape	31
		(Card)		Recording still images on a memory card	50
		(Tape)		Playing movies from a tape	36
		(Card)		Playing back still images from a memory card	52

## Using the Menu

Many of the camcorder's functions can be adjusted from the menus that open after pressing the FUNC. button (FUNC.).

For details about the available menu options and settings, refer to the appendix *Menu Options Lists* (72).

### Selecting a FUNC. Menu Option

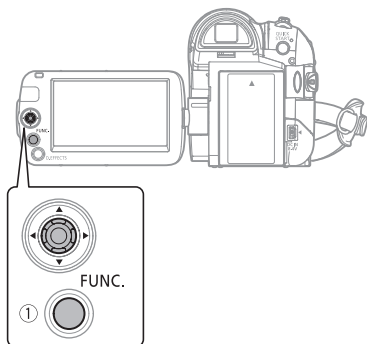

1 Press FUNC. .

2 Select (▲▼) the icon of the function you want to change from the left side column.

Menu items not available will appear grayed out.

3 Select (◀▶) the desired setting from the available options at the bottom bar.

- The selected option will be highlighted in light blue. Menu items not available will appear grayed out.
- With some settings you will need to make further selections and/or press (⊙). Follow the additional operation guides that will appear on the screen (such as the joystick icon ⬆, small arrows, etc.).

4 Press FUNC. to save the settings and close the menu.

You can press FUNC. to close the menu at any time.

### Selecting an Option from the Setup Menu

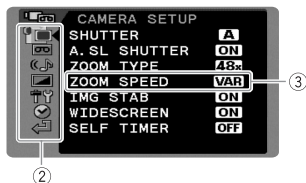
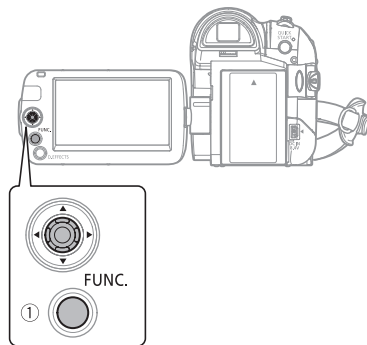





**1 Press [FUNC].**

In the still image index screen, the setup menus will open. Skip to step 3.

**2 Select (▲▼) the  icon and press (⊗) to open the setup menus.**

**3 Select (▲▼) the desired menu from the left side column and press (⊗).**

The title of the selected menu appears on top of the screen and under it the list of settings.

**4 Select (▲▼) the setting you want to change and press (⊗).**

- An orange frame will indicate the menu item currently selected. Menu items not available will appear grayed out.
- To return to the menu selection screen, select (▼) [ RETURN] and press (⊗).

**5 Select (▲▼) the desired option and press (⊗) to save the setting.**

**6 Press [FUNC].**









You can press [FUNC.] to close the menu at any time.

** NOTES**

Instead of steps 1 and 2, you can also keep [FUNC.] pressed down for more than 1 second to open the setup menus screen directly.





**Abbreviation of Menu Selections in this Manual**

In this manual, the  arrow is used to abbreviate menu selections. Below is an example of changing a setting using the setup menus.

[FUNC.]   
[ MENU]   
[ DISPLAY SETUP/]   
[LANGUAGE]   
Desired language 

[FUNC.]

For selections in the FUNC. menu, the abbreviated form will always show the initial default value. In recording mode, its icon will appear on the left side column when you first open the menu. If the setting was changed, the icon of the currently selected option will appear instead.

[FUNC.]   
[ OFF IMAGE EFFECT OFF]   
Desired image effect 

[FUNC.]

## First Time Settings

### Changing the Language

The language for on-screen and menu displays can be changed. The list of available languages depends on the region where you purchased the camcorder.

◆ Default value

#### Language Set A

German, English◆, Spanish, French, Italian, Polish, Russian, Simplified Chinese and Japanese.

#### Language Set B

English◆, Simplified Chinese, Traditional Chinese and Korean.

**FUNC.**  
( [ ] 24)



**FUNC.** >

[ MENU ] >

[ DISPLAY SETUP/ ] >

[ LANGUAGE ] >

Desired language >

**FUNC.**

### **i** NOTES

- If you changed the language by mistake, follow the  mark next to the menu item to change the setting.
- The display **FUNC.** that appears in some menu screens refers to the name of the button on the camcorder and will not change, regardless of the language selected.

### Changing the Time Zone

Change the time zone to match your location. The default setting is New York or Singapore, depending on the region of purchase.

**FUNC.**  
( [ ] 24)



**FUNC.** >

[ MENU ] >

[ DATE/TIME SETUP ] >

[ T.ZONE/DST ] >

Desired time zone\* >

**FUNC.**

\* To adjust for daylight saving time, select the time zone with the  mark next to the area.

### World Time Zones

Once you have set the time zone, date and time, you do not need to reset the clock every time you travel to another time zone. Select the time zone to match the local time at your destination, referring to the date and time displayed on the screen.



---

---

## Setting the Date and Time

**FUNC.**  
( 24)



### 1 Open the date and time setup screen.

DATE/TIME SETUP   
[DATE/TIME]

Blinking arrows will be displayed around the first field of the date.

### 2 Change each field of the date and time with the joystick ( ) and move () to the next field.

### 3 Press () to start the clock.

### 4 Press to close the menu.

## NOTES

You can also change the date format ( 78).

---

---

## Getting Ready to Start Recording

### Opening the Lens Cover and Adjusting the LCD Screen

Before you start recording, open the lens cover.

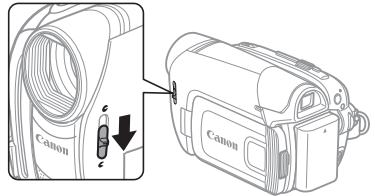

Move the lens cover switch down to to open the lens cover.

### Rotating the LCD Panel

Open the LCD panel 90 degrees.

You can rotate the panel 90 degrees downward.

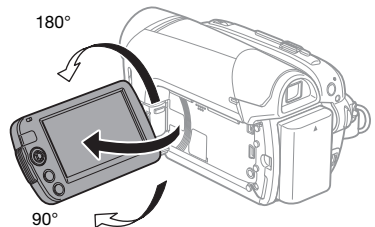

You can rotate the panel 180 degrees toward the lens (allowing the subject to monitor the LCD screen while you use the viewfinder). This is the only case where you can use the viewfinder and

the LCD screen simultaneously. Rotating the LCD panel 180 degrees can be useful in the following cases:

- When you wish to include yourself in the picture when recording with the self timer.
- To allow the camcorder to be operated with the wireless controller from the front.

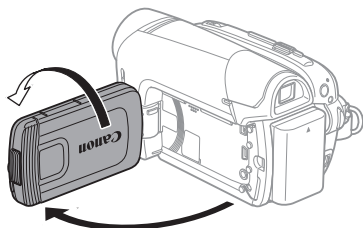

Subject can monitor the LCD screen

### **i** NOTES

**About the LCD and viewfinder screen:** The screens are produced using extremely high-precision manufacturing techniques, with more than 99.99% of the pixels operating to specification. Less than 0.01% of the pixels may occasionally misfire or appear as black, red, blue or green dots. This has no effect on the recorded image and does not constitute a malfunction.

## LCD Backlight

You can set the brightness of the LCD screen to normal or bright.

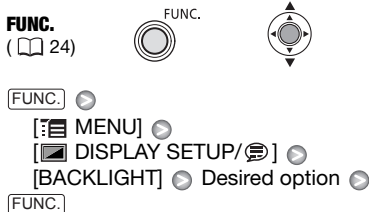

### **i** NOTES

- This setting does not affect the brightness of the recording or the viewfinder screen.
- Using the [BRIGHT] setting will shorten the effective usage time of the battery pack.



## Inserting and Removing a Tape

Use only videocassettes marked with the **Mini DV** logo.

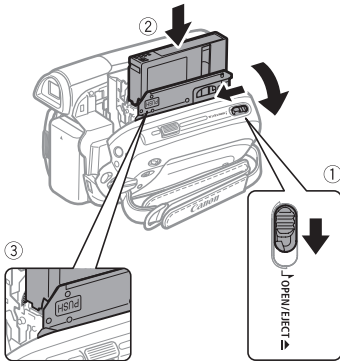

- 1 Slide **OPEN/EJECT** fully in the direction of the arrow and open the cassette compartment cover.

The cassette compartment opens automatically.

- 2 Insert the cassette.

- Insert the cassette with the window facing the grip belt.
- To remove a cassette pull it straight out.

- 3 Press the **PUSH** mark on the cassette compartment until it clicks.

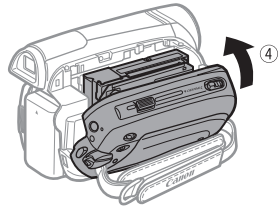

- 4 Wait for the cassette compartment to retract automatically and close the cassette compartment cover.

### IMPORTANT



- Do not interfere with the cassette compartment while it is opening or closing automatically, or attempt to close the cover before the cassette compartment has fully retracted.
- Be careful not to get your fingers caught in the cassette compartment cover.

### NOTES

If the camcorder is connected to a power source, cassettes can be inserted/removed even if the **POWER** switch is set to **OFF**.



## Inserting and Removing a Memory Card

You can use commercially available  SDHC (SD High Capacity) memory cards,  SD memory cards or MultiMedia cards (MMC) with this camcorder.

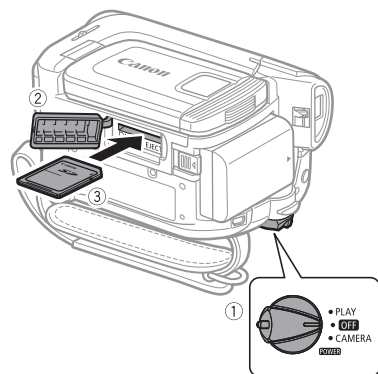

- 1 Turn off the camcorder.
- 2 Open the memory card slot cover.
- 3 Insert the memory card straight all the way into the memory card slot.
- 4 Close the cover.

Do not force the cover closed if the memory card is not correctly inserted.

### TO REMOVE THE MEMORY CARD

First push the memory card once to release it, and then pull the card out.

### ! IMPORTANT

- Make sure to initialize all memory cards before using them with this camcorder ( 56).
- Memory cards have front and back sides that are not interchangeable. Inserting a memory card facing the wrong direction can cause a malfunction of the camcorder.

### i NOTES

- Compatibility with all SD, SDHC or MMC memory cards cannot be guaranteed.
- **About SDHC Memory Cards:** SDHC is the new type of SD memory card with capacities over 2 GB. Please note that the specifications of SDHC memory cards are different from those of regular SD memory cards and you will not be able to use memory cards of over 2 GB with devices that do not support SDHC. However, SDHC devices (including this camcorder) are backward compatible and support regular SD memory cards.



# Video

This chapter covers functions related to shooting and playing back movies – from basic recording and zooming to more advanced manual picture adjustments.

## Basic Recording

### Shooting Video

#### Before You Begin Recording

Make a test recording first to check if the camcorder operates correctly. If necessary, clean the video heads ( 2).



( 23)

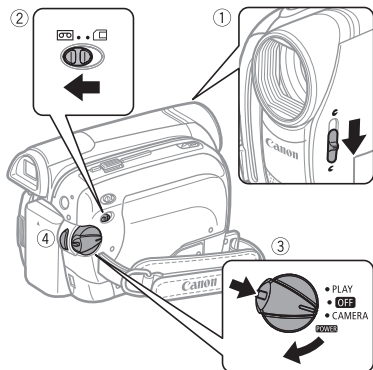

- 1 Move the lens cover switch down to to open the lens cover.
- 2 Move the / switch to (tape).

- 3 Holding the lock button pressed down, set the **POWER** switch to **CAMERA**.

- 4 Press to begin recording.

Press again to pause the recording.

#### WHEN YOU HAVE FINISHED RECORDING

- 1 Close the lens cover and the LCD panel.
- 2 Turn off the camcorder.
- 3 Remove the tape.
- 4 Disconnect the power source and remove the battery pack.

#### ! IMPORTANT

**When recording movies, try to get a calm, stable picture.**

Excessive camcorder movement while shooting and extensive use of fast zooms and panning can result in jittery scenes. In extreme cases, the playback of such scenes may result in visually induced motion sickness. If you experience such a reaction, immediately stop the playback and take a rest break as necessary.

## **i** NOTES

- **About the recording time:** By changing the recording mode you can change the video quality and as a result, also the available recording time (□ 75).
- Previous recordings overwritten by a new recording cannot be recovered. Before you start recording, search for the end of the last recording (□ 38).
- To protect the tape and video heads, the camcorder will enter the stop mode (■) if left in record pause (● ||) mode for 4 minutes 30 seconds. To resume recording press [Start/Stop].
- **About the Power Save mode:** To save power when the camcorder is powered by a battery pack, the camcorder will automatically shut off if left without any operations for 5 minutes (□ 78). To restore the power, turn the camcorder off and then on again.
- When recording in very loud places (such as fireworks shows or concerts), sound may become distorted or it may not be recorded at the actual levels. This is not a malfunction.

### Using the Viewfinder

When recording in bright places it may be difficult to use the LCD screen. In such case, change the brightness of the LCD screen (□ 28, 76) or use the viewfinder instead. To use the viewfinder, keep the LCD panel closed\*.

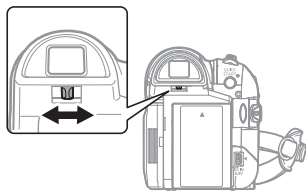

Adjust the viewfinder as necessary with the dioptic adjustment lever.

\* The LCD screen and the viewfinder can be used simultaneously only when the LCD panel is turned 180 degrees to face the subject (□ 27).

### About the Mode Switch and Recording Programs

Set the mode switch to **EASY** to let the camcorder adjust all the settings for you, allowing you to just point the camcorder and start shooting.



Set the mode switch to **P** to select one of the recording programs. The Special Scene recording programs (□ 40) offer a convenient way to select the optimal settings to match special recording conditions. The **[P PROGRAM AE]** recording program (□ 42), on the other hand, allows you to set the shutter speed you want, or enjoy the flexibility to change other settings.







## Zooming: Optical, Advanced and Digital Zoom

The camcorder offers three types of zoom: optical, advanced and digital zoom when recording movies. (In **[CAMERA]** mode only the optical zoom is available.) You can also change the zoom speed.

### Selecting the Zoom Type



#### Options

♦ Default value

##### [OPTICAL] (37x)

The zoom range is limited to the optical magnification ratio of the lens.

##### [ADVANCED]♦ (Advanced Zoom)

In addition to the optical zoom range, the camcorder processes the image digitally to obtain a larger zoom range without any deterioration in image quality. When recording movies with a 16:9 aspect ratio, the field of view (picture angle) will change. Refer to the table in the NOTES section.

##### [DIGITAL] (2000x)

When this option is selected, the camcorder will switch to digital zoom (light blue area on the zoom indicator) when you zoom in beyond the optical zoom range (white area on the zoom indicator). With the digital zoom the image is processed digitally so image quality will deteriorate the more you zoom in.

- FUNC.
- [MENU]
- [CAMERA SETUP]
- [ZOOM TYPE] Desired option
- FUNC.

### NOTES

The zoom range of the advanced zoom will change depending on the aspect ratio of the scene ( 74).

#### [WIDESCREEN] set to [ON ON] (16:9)

48x\*

\* The picture angle will be wider at both full telephoto and full wide-angle.

#### [WIDESCREEN] set to [OFF OFF] (4:3)

55x

### Selecting the Zoom Speed



#### Options

♦ Default value

##### [VAR VARIABLE]♦

The variable zoom speed depends on how you operate the zoom lever: Press gently for slower zooms; press harder for faster zooms. With this option, the zoom speed will be faster in record pause mode.

##### [> SPEED 1], [>> SPEED 2], [>>> SPEED 3]

Constant zoom speeds. [>>> SPEED 3] is the fastest, and [> SPEED 1] is the slowest.

**FUNC.**  
( 24)



**FUNC.**  
( 24)



**FUNC.**

[ MENU ]

[ CAMERA SETUP ]

[ ZOOM SPEED ]

Desired option

**FUNC.**

## NOTES

The fastest zoom speed can be achieved with the [ VARIABLE ] setting.

## Using the Zoom

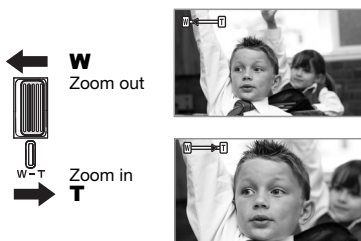

**Move the zoom lever toward **W** to zoom out (wide-angle). Move it toward **T** to zoom in (telephoto).**

## NOTES

- Keep at least 1 m (3.3 ft.) to the subject. At full wide-angle, you can focus on a subject as close as 1 cm (0.39 in.).
- You can also use the **T** and **W** buttons on the wireless controller. The zoom speed with the wireless controller will be the same as with the camcorder or fixed at [ SPEED 3 ] (when [ VARIABLE ] is selected).

## Quick Start Function

When you press [ QUICK START ] the camcorder enters the standby mode. In standby mode the camcorder consumes only about half the power used when recording, saving energy when you are using a battery pack. Additionally, when you press [ QUICK START ] again the camcorder is ready to start recording within approx. 1 second, ensuring you do not miss important shooting opportunities.

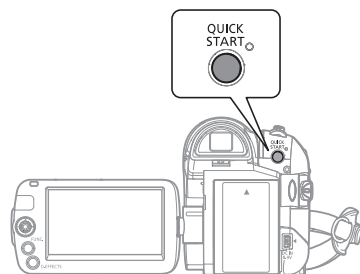

### 1 Press [ QUICK START ] firmly.

The standby lamp flashes at first while the camcorder is preparing and then stays on when it enters the standby mode.

### 2 When you wish to resume recording, press [ QUICK START ] again.

Within approx. 1 second, the camcorder is ready to record.



## **i** NOTES

- When you wake up the camcorder from standby mode, the following settings will be changed automatically:
  - Manual focus returns to automatic focus (AF).
  - Manual exposure adjustment returns to automatic exposure.
  - Zoom position returns to full wide-angle **W**.
- The camcorder will shut off if left in standby mode for 10 minutes, regardless of the [POWER SAVE] setting (□ 78). To restore the power if the camcorder shut off, turn the camcorder off and then on again.
- The camcorder will be woken up from standby mode if you open the cassette compartment cover or change the position of the / switch while the camcorder is in standby mode (standby lamp is on).

## Reviewing the Last Scene Recorded

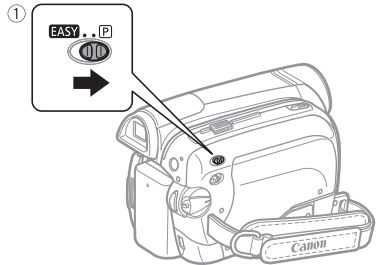

- 1 Set the mode switch to .**
- 2 If the joystick guide does not appear on screen, press to display it.**
- 3 Push the joystick () momentarily toward and release it.**
  - The camcorder will play back a few seconds of the last recording made and return to record pause mode.
  - You can also hold the joystick pressed ( toward or toward to play back the tape (reverse or forward respectively) in order to locate the point where you want to start recording.

## Basic Playback

### Playing Back Video

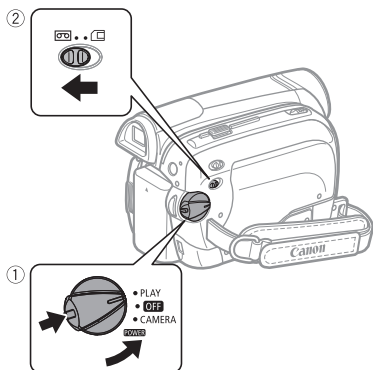

- 1 Holding the lock button pressed down, set the **POWER** switch to **PLAY**.
- 2 Move the / switch to .
- 3 If the joystick guide does not appear on screen, press ( ) to display it.

- 4 Locate the point where you want to begin the playback.

Push the joystick ( ) toward to rewind the tape or ( ) toward to fast forward.

- 5 Push the joystick ( ) toward to begin the playback.

### DURING PLAYBACK

- 6 Push the joystick ( ) toward again to pause the playback.
- 7 Push the joystick ( ) toward to stop the playback.

### TO ADJUST THE VOLUME

During the playback of a scene:



- The sound from the built-in speaker will be muted when you close the LCD panel or while the STV-250N Stereo Video Cable is connected to the AV terminal.
- If you turn down the volume completely, the icon will change to .











### NOTES

- You can display the date and time of the recording ( 39).
- To protect the tape and video heads, the camcorder will enter the stop mode ( ) if left in playback pause ( ) mode for 4 minutes 30 seconds. To resume the playback push the joystick ( ) toward .



## Special Playback Modes<sup>1</sup>

To enter most special playback modes you need to operate the buttons on the wireless controller (□ 15). There is no sound during the special playback modes.

Special playback mode	Initial mode	Operation on the camcorder  or on the wireless controller 
Fast playback	Normal playback	 : Push the joystick (◀) toward ◀◀ or (▶) toward ▶▶ and hold it down.  : Press and hold <b>REW◀◀</b> or <b>FF▶▶</b>
Reverse playback	Normal playback	 : Press <b>◀/▶</b>
1 frame reverse/advance	Playback pause	 : Press <b>◀/▶</b> or <b>+/■</b>
Frame-by-frame playback	Playback pause	 : Press and hold <b>◀/▶</b> or <b>+/■</b>
Slow playback	Normal or reverse playback	 : Press <b>SLOW▶</b>
Double speed playback	Normal or reverse playback	 : Press <b>× 2</b>
Return to normal playback	Special playback mode	 : Push the joystick (▲) toward ▶/■.  : Press <b>PLAY▶</b>

<sup>1</sup> During some special playback modes you may notice some anomalies (blocky video artifacts, banding, etc.) in the playback picture.

## Returning to a Pre-marked Position

If you wish to return to a particular scene later, mark the point with the zero set memory and the tape will stop at that point when you rewind/fast forward the tape. This function is operated with the wireless controller.



**1 While recording or during playback, press **ZERO SET MEMORY** at the point you wish to return to later.**

- The time code changes to “0:00:00 

**2 If you marked the zero memory while recording, set the camcorder to **PLAY** mode. If you marked the zero memory during playback, press **STOP**.**

**3 Press **◀◀** to locate the zero mark.**

- If the tape counter shows a negative number, press **▶▶** instead.
- **◀◀** appears and the camcorder rewinds/fast forwards the tape.
- The tape stops at or near the zero mark,  disappears and the correct time code will be displayed again.

**i** NOTES

If there are blank sections between recordings, the zero set memory may not work correctly.

**Locating the Beginning of a Recording Date**

You can locate the change of the date/time zone with the date search function.



Press **◀◀** or **▶▶** on the wireless controller.

- Press more than once to search for further date changes (up to 10 times).
- To cancel the search press **STOP**.

**i** NOTES

- The date search function will not detect recordings shorter than 1 minute per date/time zone.
- Date search may not function if the data code is not displayed correctly.

**Locating the End of the Last Scene**

After playing back a tape, use this function to locate the end of the last scene recorded in order to continue recording from that point.

**POINTS TO CHECK**

Stop the playback before using this function.



**FUNC.** **[▶▶ END SEARCH] [EXECUTE]**

- “END SEARCH” appears.
- The camcorder rewinds/fast forwards the tape, plays back the last few seconds of the recording and stops the tape.
- To cancel the end search push the joystick (**▼**) toward **■**.

**i** NOTES

- End search cannot be used once you remove the cassette.
- If there are blank sections between recordings, the end search may not work correctly.
- You cannot use the end search to locate the end of a scene that was audio dubbed.



## On-Screen Displays (Data Code)

The camcorder keeps a data code containing the date and time of recording. You can select the data to be displayed.



### Options

◆ Default value

[ OFF OFF ] ◆
No data code display.
[ [☐] DATE ], [ [⊙] TIME ]
Displays the date or time when the scene or still image was recorded.
[ [☐⊙] DATE & TIME ]
Displays both the date and time of the recording.

**FUNC.**  
( 24 )



FUNC. ➤

[ MENU ] ➤

[ DISPLAY SETUP/ ] ➤

[ DATA CODE ] ➤ Desired option ➤

FUNC.

## Advanced Functions

### [P]: Special Scene Recording Programs

Recording in a very bright ski resort or capturing the full colors of a sunset or a fireworks display becomes as easy as selecting a Special Scene recording program. For details about the available options, refer to the sidebar on page 41.



### POINTS TO CHECK

Mode switch: [P]

**FUNC.**  
( 24)



FUNC. >

[P PROGRAM AE] >

Desired recording program >

FUNC.

### i NOTES

- Do not set the mode switch to **EASY** during the actual recording of a scene; the brightness of the picture may change abruptly.
- [SPORTS]/[BEACH]/[SNOW]
  - The picture may not appear smooth during playback.
- [PORTRAIT]
  - The blur effect of the background increases the more you zoom in (T).
- [NIGHT]
  - Moving subjects may leave a trailing afterimage.
  - Picture quality may not be as good as in other modes.
  - White points may appear on the screen.
  - Autofocus may not work as well as in other modes. In such case, adjust the focus manually.
- [SNOW]/[BEACH]
  - The subject may become overexposed on cloudy days or in shaded places. Check the image on the screen.
- [FIREWORKS]
  - To avoid camcorder shake, we recommend using a tripod. Make sure to use a tripod especially in **CAMERA** mode, as the shutter speed slows down.



**[P PROGRAM AE]**

The camcorder sets the aperture and shutter speed.

**[BEACH]**

Use this mode to record on a sunny beach. It prevents the subject from being underexposed.

**[PORTRAIT]**

The camcorder uses a large aperture, achieving a focus on the subject while blurring other distracting details.

**[SUNSET]**

Use this mode to record sunsets in vibrant colors.

**[SPORTS]**

Use this mode to record sports scenes such as tennis or golf.

**[SPOTLIGHT]**

Use this mode to record spotlight scenes.

**[NIGHT]**

Use this mode to record in low-light conditions.

**[FIREWORKS]**

Use this mode to record fireworks.

**[SNOW]**

Use this mode to record in bright ski resorts. It prevents the subject from being underexposed.



## **P Flexible Recording: Changing the Shutter Speed**

Use the automatic exposure (AE) program to use functions like the white balance or image effects, or to select the shutter speed.

Use faster shutter speeds to record subjects moving quickly. Use slower shutter speeds to add motion blur, emphasizing the feel of movement.



### **POINTS TO CHECK**

Mode switch: **P**

**FUNC.**  
( 24)



**1** Press **FUNC.**.

**2** Select the **[P PROGRAM AE]** recording program ( 40).

**[P PROGRAM AE]** is the default value; proceed directly to step 3 if you have not changed the recording program.

**3** Select the shutter speed from the setup menus.

**FUNC.** **[MENU]**

**[CAMERA SETUP]**

**[SHUTTER]** Desired shutter speed **FUNC.**

## **Shutter speed guidelines**

Note that on screen only the denominator is displayed – **[P 250]** indicates a shutter speed of 1/250 second, etc.

1/60
To record under most ordinary conditions.
1/100
To record indoor sports scenes.
1/250, 1/500*, 1/1000*
To record from within a moving car or train or to shoot fast-moving subjects such as roller coasters.
1/2000*
To record outdoor sports scenes on sunny days.

\* **CAMERA** mode only.

### **i NOTES**

- Do not set the mode switch to **EASY** during the actual recording of a scene; the brightness of the picture may change abruptly.
- [P PROGRAM AE]**
  - When setting the shutter speed, the number displayed will flash if the value selected is not appropriate for the recording conditions. In such case, select a different value.
  - If you use a slow shutter speed in dark places, you can obtain a brighter image, but the image quality may be lower, and the autofocus may not work well.
  - The image may flicker when recording with high shutter speeds.



- **Recording movies under fluorescent lights:**  
If the screen starts to flicker, select [P PROGRAM AE] and set the shutter speed to 1/100.
- The shutter speed resets to [A AUTO] when you set the mode switch to **EASY** or change the recording program.

## LCD Video Light

You can use the LCD video light to record in completely dark places. For a brighter picture, we recommend keeping a distance of about 20 cm - 60 cm (8 in. - 2 ft.) from the subject and/or using the [NIGHT] recording program. When you activate the LCD video light, rotate the LCD panel to face the subject and use the viewfinder instead (□ 32).



**FUNC.**  
(□ 24)

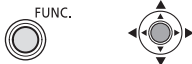

[FUNC.]

[LCD LIGHT OFF]

[LCD LIGHT ON]

Press ( )

- The LCD display turns entirely white when used as the video light. Use the viewfinder instead.
- Using the viewfinder, select [LCD LIGHT OFF] to turn the LCD video light off.

## Self Timer



### POINTS TO CHECK

**CAMERA (video)**: Set the camcorder to record pause mode.

**FUNC.**  
(□ 24)

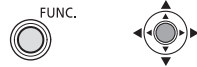

#### 1 Activate the self timer.

[FUNC.] [MENU]

[CAMERA SETUP]

[SELF TIMER] [ON ON]

#### 2 Press [FUNC.] to close the menu.

- ☺ appears.
- Set [SELF TIMER] to [OFF OFF] to cancel the self timer.

#### 3 Press [Start/Stop] on the camcorder to start recording.

- The camcorder starts recording video (CAMERA (video) mode) or takes a still image (CAMERA (photo) mode) after a 10-second countdown. The countdown appears on the screen.
- You can also press [START/STOP] (CAMERA (video) mode) or [PHOTO] (CAMERA (photo) mode) on the wireless controller. In that case, the countdown will be only 2 seconds.

### NOTES

Once the countdown has begun, you can press [Start/Stop] again or turn off the camcorder to cancel the self timer.

## Audio Recording Mode

You can change the quality of the audio recording.



### Options

♦ Default value

[ 16bit 16bit]
Records audio at the highest quality.
[ 12bit 12bit]♦
Records audio on 2 channels (Stereo 1) leaving 2 free channels (Stereo 2) you can use for audio dubbing. With this camcorder you can dub audio only using the microphone (23 66).

**FUNC.**  
( 24)



[FUNC.]

[MENU]

[AUDIO SETUP]

[AUDIO MODE]

Desired option

[FUNC.]

## ABOUT THE WIND SCREEN

The camcorder automatically reduces the background sound of wind. You can turn the wind screen off when you want the microphone to be as sensitive as possible (23 75).

## Audio Playback Modes

### Selecting the Audio Channel

You can select the audio channel to play back when playing back a tape with audio recorded on two channels (either stereo sound or bilingual audio signals).



### Options

♦ Default value

[ L/R]♦
Left and right channels (stereo) / Main and sub signals (bilingual).
[ L/L]
Left channel only (stereo) / Main signal only (bilingual).
[ R/R]
Right channel only (stereo) / Sub signal only (bilingual).

**FUNC.**  
( 24)



[FUNC.]

[MENU]

[AUDIO SETUP]

[OUTPUT CH] Desired option

[FUNC.]



## Selecting the Audio Track on a Tape with Dubbed Audio

You can select the audio track to play back when playing back a tape that has a dubbed audio track (Stereo 2) in addition to the original recorded audio (Stereo 1).



### Options

◆ Default value

[ST-1 STEREO1]◆
Original sound only.
[ST-2 STEREO2]
Dubbed audio only.
[1:1 MIX/FIXED]
Mixed audio with the original sound and the dubbed audio at the same level.
[MIX/VAR.]
Mixed audio where the balance between the original sound (ST-1) and the dubbed audio (ST-2) can be adjusted.

**FUNC.**  
( 24)



**FUNC.** ●

[MENU] ●

[AUDIO SETUP] ●

[12bit AUDIO] ● Desired option\* ●

**FUNC.**

\* When you select [MIX/VAR.], adjust the mix balance with the [MIX BALANCE] setting ( 75).

## Manual Focus Adjustment

Autofocus may not work well on the following subjects. In such case, focus manually.

- Reflective surfaces
- Subjects with low contrast or without vertical lines
- Fast moving subjects
- Through wet windows
- Night scenes



### POINTS TO CHECK

Adjust the zoom before you start the procedure.

Mode switch: P



**1** If the joystick guide does not appear on screen, press ( ) to display it.

**2** Push the joystick (▼) toward [FOCUS] to activate the manual focus.

[FOCUS] on the joystick guide will be displayed in light blue and “MF” appears on the screen.

**3** Adjust (◀▶) the focus as necessary.

- Push the joystick (▶) toward ▲ for a farther focal distance or push it (◀) toward ■ for a closer focal distance.

- Pushing the joystick (▼) toward [FOCUS] again will return the camcorder to autofocus.

#### 4 Push the joystick (▲) toward [BACK] to save the focus adjustment.

### Infinity Focus

Use this function when you wish to focus on faraway subjects such as mountains or fireworks.

#### POINTS TO CHECK

Adjust the zoom before you start the procedure.

Mode switch: [P]



#### 1 Keep the joystick pushed (▼) toward [FOCUS] for more than 2 seconds.

- ∞ appears.
- Pushing the joystick (▼) toward [FOCUS] again will return the camcorder to autofocus.
- If you operate the zoom or the joystick (◀▶), ∞ changes to "MF" and the camcorder returns to manual focusing mode.

#### 2 Push the joystick (▲) toward [BACK] to save the focus adjustment.

#### NOTES

The camcorder will automatically return to autofocus when you set the mode switch to **EASY**.

### Manual Exposure Adjustment

At times, backlit subjects may appear too dark (underexposed) or subjects under very strong lights may appear too bright or glaring (overexposed). To correct this, you can manually adjust the exposure.



#### POINTS TO CHECK

Mode switch: [P] (except for the [FIREWORKS] recording program).



#### 1 If the joystick guide does not appear on screen, press (⊗) to display it.

#### 2 Push the joystick (▲) toward [EXP].

[EXP] on the joystick guide changes to light blue and the exposure adjustment indicator  and the neutral value "±0" appear on the screen.

#### 3 Adjust (◀▶) the brightness of the image as required.

- The adjustment range and the length of the exposure adjustment indicator will vary depending on the initial brightness of the picture.
- Pushing the joystick (▲) toward [EXP] again will return the camcorder to automatic exposure.



#### 4 Push the joystick (▼) toward [BACK] to lock and save the exposure setting.

If you operate the zoom during exposure lock, the brightness of the image may change.

FUNC.  
( [ ] 24)



FUNC. [ ]

[ AWB AUTO ] [ ] Desired option\* [ ]

FUNC. [ ]

\* When you select [ ] SET, do not press [ ] and continue instead with the procedure below.

## White Balance

The white balance function helps you accurately reproduce colors under different lighting conditions so that white objects will always look truly white in your recordings.



### POINTS TO CHECK

Recording program: [ P PROGRAM AE ]

#### Options

◆ Default value

[ AWB AUTO ]◆
Settings are automatically set by the camcorder. Use this setting for outdoor scenes.
[ DAYLIGHT ]
For recording outdoors on a bright day.
[ TUNGSTEN ]
For recording under tungsten and tungsten type (3-wavelength) fluorescent lighting.
[ SET ]
Use the custom white balance setting to make white objects appear white under colored lighting.

## TO SET THE CUSTOM WHITE BALANCE

- 1 Point the camcorder at a white object, zoom in until it fills the whole screen and press ( ). When the adjustment is completed, [ ] stops flashing and stays on. The camcorder retains the custom setting even if you turn off the camcorder.
- 2 Press [ ] to save the setting and close the menu.

### NOTES

- When you select the custom white balance:
  - Set the custom white balance in a sufficiently illuminated place.
  - Select a zoom type other than [ 2000x DIGITAL ] ( [ ] 33).
  - Reset the white balance when the lighting conditions change.
  - Depending on the light source, [ ] may keep flashing. The result will still be better than with [ AWB AUTO ].
- Custom white balance may provide better results in the following cases:
  - Changing lighting conditions
  - Close-ups
  - Subjects in a single color (sky, sea or forest)

- Under mercury lamps and certain types of fluorescent lights

## Image Effects

You can use the image effects to change the color saturation and contrast to record images with special color effects.



### POINTS TO CHECK

Recording program: [P PROGRAM AE]

#### Options

◆ Default value

[ <b>OFF</b> IMAGE EFFECT OFF]◆
Records with no image enhancing effects.
[ <b>V</b> VIVID]
Emphasizes the contrast and color saturation.
[ <b>N</b> NEUTRAL]
Tones down the contrast and color saturation.
[ <b>SD</b> SOFT SKIN DETAIL]
Softens the details in the skin tone area for a more complimentary appearance. To obtain the best effect, use this setting when recording a close-up of a person. Note that areas similar to the skin color may lack in detail.

**FUNC.**  
( 24 )



**FUNC.**   
 [ **OFF** IMAGE EFFECT OFF ]   
 Desired option   
 **FUNC.**

## Digital Effects



### POINTS TO CHECK

Mode switch: [P]

**CAMERA** : [ **F1** BLK&WHT ] only.

#### Options

◆ Default value

[ <b>OFF</b> D.EFFECT OFF]◆
Select this setting when you do not intend to use the digital effects.
[ <b>F1</b> FADE-T ] (fade trigger), [ <b>F2</b> WIPE ]
Select one of the faders to begin or end a scene with a fade from or to a black screen.
[ <b>F1</b> BLK&WHT ]
Records images in black and white.
[ <b>F2</b> SEPIA ]
Records images in sepia tones for an "old" look.
[ <b>F3</b> ART ], [ <b>F4</b> MOSAIC ]
Select one of these digital effects to add "flavor" to your recordings.





## Setting

**FUNC.**  
( 24 )



**FUNC.**

[ ] D.EFFECT OFF

Desired option\*

**FUNC.**\*\*

\* While making the selection, you can preview the effect on the screen.

\*\* The icon of the selected effect appears.

## Applying



Press **D.EFFECTS** to activate the fader/effect.

- The icon of the selected effect turns green.
- Press **D.EFFECTS** again to deactivate the fader/effect.

## To FADE IN

Press **D.EFFECTS** ...

**CAMERA** : ...in record pause mode, then press **Start/Stop** to start recording with a fade in.

**PLAY** : ...in playback pause mode, then push the joystick () toward to fade in and start the playback.

## To FADE OUT

Press **D.EFFECTS** ...

**CAMERA** : ...while recording, then press **Start/Stop** to fade out and pause the recording.

**PLAY** : ...during playback, then push the joystick () toward to fade out and pause the playback.

## To ACTIVATE AN EFFECT

Press **D.EFFECTS** ...

**CAMERA** : ...while recording or in record pause mode.

**PLAY** : ...during playback.

**CAMERA** : ...and then press **Start/Stop** to record the still image in black and white.

## NOTES

- When you apply a fader, not only the picture but also the sound will fade in or out. When you apply an effect, the sound will be recorded normally.
- The camcorder retains the last setting used even if you turn off the digital effects or change the recording program.
- The digital effects are not available when [TV TYPE] is set to [NORMAL TV] and the stereo video cable is connected to the AV terminal.



3



# Photos

Refer to this chapter for details on shooting photos – from capturing and playing back images to printing them.

## Basic Recording

### Taking Photos

Before using a memory card for the first time, be sure to initialize it with this camcorder ( 56).

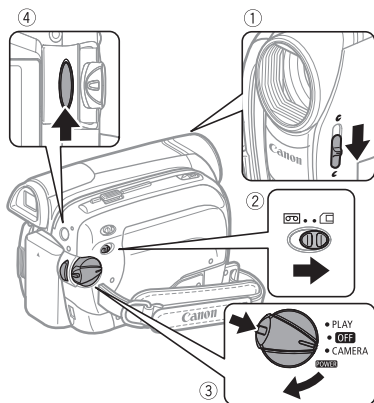

**1** Move the lens cover switch down to to open the lens cover.

**2** Move the / switch to (memory card).

**3** Holding the lock button pressed down, set the **POWER** switch to **CAMERA**.

**4** Press .

- Once the focus is automatically adjusted, will turn green and one or more AF frames will appear.
- You can also press on the wireless controller.
- The CARD access indicator will flash as the image is being recorded.

### ! IMPORTANT

Observe the following precautions while the card access display () appears on screen, and when the CARD access indicator is on or flashing. Failing to do so may result in permanent data loss.

- Do not open the memory card slot cover and do not remove the memory card.
- Do not disconnect the power source or turn off the camcorder.
- Do not change the position of the / switch or the operating mode.

### i NOTES

If the subject is not suitable for autofocus, turns yellow. Adjust the focus manually ( 45).



## Selecting Photo Size and Quality

Still images are recorded on the memory card using JPEG compression. As a general rule select a larger image size for higher quality.



### Options

Image size options and the approximate number of still images that can be recorded on memory cards of various sizes are given in the table below.

**FUNC.**  
( 24)



**FUNC.**

[ 1152x864 ]

Desired image size\*

Desired image quality\*

**FUNC.**

\* Press to move back and forth between size and quality selection. The number displayed on the right corner indicates the approximate number of

images that can be recorded with the current quality/size setting.

### NOTES

- Depending on the number of images on the memory card (Windows: 1,800 images or more; Macintosh: 1,000 images or more), you may not be able to transfer images to a computer. Try using a card reader.
- Connection to a PictBridge-compatible printer will not work when the memory card contains 1,800 images or more. For best performance, we recommend keeping the number of images on the memory card under 100.
- When printing still images, use the following guidelines as a reference for selecting the print size.

Image size	Recommended use
<b>L</b> 1152x864	To print photos up to L size (9 x 13 cm, 3.5 x 5 in.) or postcard size (10 x 14.8 cm, 4 x 6 in.).
<b>S</b> 640x480	To send images as e-mail attachments or to post on the Web.

### Approximate number of still images on a memory card

◆ Default value

Memory card	32 MB			128 MB			512 MB		
		◆			◆			◆	
Image quality* →									
Image size ↓									
<b>L</b> 1152x864 ◆	40	65	130	185	280	545	735	1,115	2,155
<b>S</b> 640x480	140	200	365	585	850	1,530	2,320	3,355	6,040

\* : [SUPER FINE], : [FINE], : [NORMAL]

## Erasing or Protecting a Photo Right After Recording It

You can erase or protect the still image recorded last while reviewing it within the time set for the [REVIEW] option (or immediately after recording it, if [REVIEW] is set to [OFF OFF]).



### POINTS TO CHECK

Make sure to press [FUNC.] while reviewing the still image immediately after recording it.

**FUNC.**  
( 24)



### TO ERASE THE PHOTO

[FUNC.]

[ IMAGE ERASE ] [ERASE ]  
Press ( )

### TO PROTECT THE PHOTO

[FUNC.]

[ OFF PROTECT OFF ]  
[ ON PROTECT ON ]  
Press ( )

[FUNC.]

## Basic Playback

### Viewing Photos

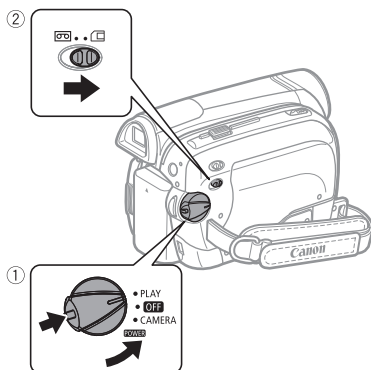

- 1 Holding the lock button pressed down, set the **POWER** switch to **PLAY**.
- 2 Move the switch to (memory card).



- 3 If the joystick guide does not appear on screen, press ( ) to display it.
- 4 Push the joystick ( ) to move between the images.



## Image Jump

You can jump to a specific image without having to browse all of them one by one.

**Push the joystick (◀▶) and hold it pressed down. Release the joystick when the image number gets to the image you want to display.**

### ! IMPORTANT

- Observe the following precautions while the card access display ► appears on screen, and when the CARD access indicator is on or flashing. Failing to do so may result in permanent data loss.
  - Do not open the memory card slot cover and do not remove the memory card.
  - Do not disconnect the power source or turn off the camcorder.
  - Do not change the position of the / switch or the operating mode.
- The following may not be displayed correctly.
  - Images not recorded with this camcorder.
  - Images edited on or transferred from a computer.
  - Images whose file names have been changed.

## Slideshow

**FUNC.**  
( 24 )



**FUNC.**

[ SLIDESHOW ] Press ( )

- Images are played back one after another.
- Press ( ) to stop the slideshow.

## Index Screen

- 1 Move the zoom lever toward W.**  
The index screen appears.
- 2 Select (▲▼, ◀▶) an image.**  
Move the cursor to the image you want to view.
- 3 Move the zoom lever toward T.**  
The index screen closes and the selected image is displayed.

## Magnifying Photos during Playback

During playback, still images can be magnified up to 5 times.

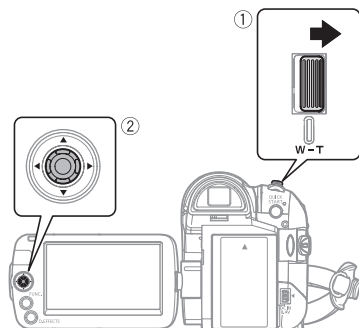

- 1 Move the zoom lever toward T.**
  - The image is magnified by 2 times and a frame appears indicating the position of the magnified area.

- To further enlarge the image, move the zoom lever toward **T**. To reduce the magnification, move the zoom lever toward **W**.
-  will appear for images that cannot be enlarged.

## 2 Move (, , , ) the frame to the part of the image you want to see enlarged.

To cancel the magnification, move the zoom lever toward **W** until the frame disappears.







---

## Erasing Photos

You can erase still images recorded on the memory card.

### Erasing a Single Image



- If the joystick guide does not appear on screen, press () to display it.
- Select () the image you want to erase.
- Push the joystick () toward .
- Select () [ERASE] and press ()

## Erasing All Images

The following procedure will erase all the non-protected still images from the memory card (all images except those with the  mark).



**FUNC.**  
( 24)



FUNC. 

[ MENU] 

[ CARD OPERATIONS] 

[ERASE ALL IMAGES]  [YES] 

FUNC.

## IMPORTANT

Be careful when erasing images. Erased images cannot be recovered.

## NOTES

Protected images on the memory card cannot be erased.



## Additional Functions

### Automatic Focus Priority

When the focus priority is activated, the camcorder records a still image only after the focus has been adjusted automatically.



### POINTS TO CHECK

Mode switch at **[EASY]**: The focus priority cannot be turned off.

Mode switch at **[P]**: You can turn off the focus priority and you can also select the AF (autofocus) frame to be used.

### Options

♦ Default value

<b>[AIR] ON: AiAF</b> ♦ (Mode switch: <b>[P]</b> *, <b>EASY</b> )
Depending on the shooting conditions, one or more AF frames out of the nine frames available are automatically selected and the focus is fixed on them.
<b>[ ] ON: CENTER</b> (Mode switch: <b>[P]</b> *)
A single focusing frame appears in the center of the screen and the focus is automatically fixed on it. This is convenient for making sure the focus is exactly where you want it.
<b>[OFF] OFF</b> (Mode switch: <b>[P]</b> )
Select this option if you wish to record a still image as soon as you press <b>[Start/Stop]</b> .

\* Except for the **[FIREWORKS]** recording program.

**FUNC.**  
( 24)



**FUNC.** >

**[MENU]** >

**[CAMERA SETUP]** >

**[FOCUS PRI.]** > Desired option >

**FUNC.**

### NOTES

In the **[FIREWORKS]** recording program the focus priority is automatically set to **[OFF OFF]**.

### Protecting Photos

You can protect still images recorded on the memory card from accidental erasure.



**FUNC.**  
( 24)



**FUNC.** >

**[OFF PROTECT OFF]** >

**[ON PROTECT ON]\*** >

Press **[ ]** >

**FUNC.**

**ON** appears and the image cannot be erased.

\* To cancel the image protection, select **[OFF PROTECT OFF]** instead.

**! IMPORTANT**

Initializing the memory card (☐ 56) will permanently erase all still images, even the protected ones.

**Initializing the Memory Card**

Initialize memory cards when you use them with this camcorder for the first time, or to erase all the still images on them.



**FUNC.**  
(☐ 24)



FUNC. ➤

[MENU] ➤

[CARD OPERATIONS] ➤

[INITIALIZE] ➤ [YES] ➤ [YES] ➤

FUNC.

**! IMPORTANT**

Initializing the memory card will erase all still images, even the protected ones. The original still images cannot be recovered.

**You can also use the following functions...**

The following functions and features of the camcorder can be used either for shooting video or for taking photos. The way to set and use them was already explained in detail, so we refer you to the relevant page in the “Video” section.

- Quick Start (☐ 34)
- Zoom (☐ 33)
- Special Scene recording programs (☐ 40)
- Flexible recording (☐ 42)
- LCD video light (☐ 43)
- Self timer (☐ 43)
- Manual focus (☐ 45)
- Manual exposure adjustment (☐ 46)
- White balance (☐ 47)
- Image effects (☐ 48)
- Digital effects (☐ 48)





## Printing Photos

### Printing Photos – Direct Print

The camcorder can be connected to any PictBridge-compatible printer. You can mark in advance the still images you want to print and set the desired number of copies as a print order (□ 59).



**Canon printers:** SELPHY printers of the CP, DS and ES series and PIXMA printers marked with the PictBridge logo.

### Connecting the Camcorder to the Printer



- 1 Insert the memory card containing the still images you want to print.
- 2 Turn on the printer.
- 3 Connect the camcorder to the printer using the supplied USB cable.
  - Refer to *PC Connection Diagrams* (□ 67).
  - appears and changes to .

### ! IMPORTANT

If continues to flash (for more than 1 minute) or if does not appear, the camcorder is not correctly connected to the printer. In such case, disconnect the USB cable and turn off the camcorder and

the printer. After a short while, turn them on again, set the camcorder to **PLAY** mode and restore the connection.

### i NOTES

- will appear for images that cannot be printed.
- We recommend powering the camcorder using the compact power adapter.
- Refer also to the printer's instruction manual.

### Selecting the Print Settings

You can select the number of copies and other settings for printing. The setting options vary depending on your printer model.

### Options

<b>[PAPER]</b>
[  ] PAPER SIZE]: Available paper sizes vary depending on the printer model.
[  ] PAPER TYPE]: Select [PHOTO], [FAST PHOTO], [PLAIN] or [DEFAULT].
[  ] PAGE LAYOUT]: Select [DEFAULT] or one of the following available page layouts. [BORDERED]: Prints the whole image area almost exactly as the recorded still image. [BORDERLESS]: Enlarges the center portion of the still image to fit the width/height ratio of the selected paper size. The top, bottom and sides of the still image may be slightly trimmed out. [2-UP], [4-UP], [8-UP], [9-UP], [16-UP]: Refer to the sidebar on page 58.

[🕒] Date print
Select [ON], [OFF] or [DEFAULT].
[🖨️] Print Effect
The print effect can be used with printers compatible with the Image Optimize function to achieve higher quality prints. Select [ON], [OFF] or [DEFAULT]. <b>Canon PIXMA/SELPHY DS printers:</b> You can also select [VIVID], [NR] and [VIVID+NR].
[📄] Number of Copies
Select 1-99 copies.

### NOTES

Print setting options and [DEFAULT] settings vary depending on the printer model. For details, refer to the printer's instruction manual.

## Printing after Changing the Print Settings



- 1 If the joystick guide does not appear on screen, press (🕒) to display it.
- 2 Push the joystick (▼) toward 🖨️. The print settings menu appears.

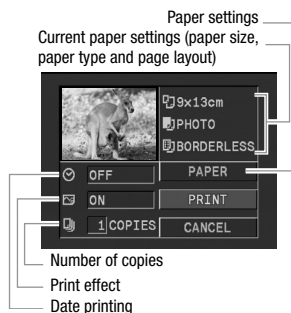

## Printing Multiple Images on the Same Sheet [2-UP], [4-UP], etc.

When using Canon printers you can print the same still image multiple times on the same sheet of paper. Use the following table as a guideline for the recommended number of copies depending on the [📄 PAPER SIZE] setting.

[📄 PAPER SIZE]→	[CREDITCARD]	[9 x 13 cm]	[10 x 14.8 cm]	[A4]
Canon printer ↓				
PIXMA SELPHY DS	–	–	2, 4, 9 or 16 <sup>1</sup>	4
SELPHY CP	2, 4 or 8 <sup>2</sup>	2 or 4	2 or 4	–
SELPHY ES	2, 4 or 8 <sup>3</sup>	2 or 4	2 or 4	–

<sup>1</sup> You can also use the special sticker sheets.

<sup>2</sup> When you use the wide-sized photo paper with the [DEFAULT] setting, you can also use [2-UP] or [4-UP].

<sup>3</sup> With the [8-UP] setting, you can also use the special sticker sheets.



**3** In the print settings menu, select (▲▼, ◀▶) the setting you want to change and press (⊗).

**4** Select (▲▼) the desired setting option and press (⊗).

**5** Select (▲▼) [PRINT] and press (⊗).

- Printing starts. The print settings menu disappears when printing is completed.
- To continue printing, select (◀▶) another still image.

#### TO CANCEL THE PRINTING

**1** Press (⊗) while printing.

**2** Select (◀▶) [OK] and press (⊗).

#### PRINTING ERRORS



If an error occurs during the printing process, an error message appears (□ 84).

- Canon's PictBridge-compatible printers: Resolve the error. When printing does not resume automatically, select [CONTINUE] and press (⊗). If [CONTINUE] cannot be selected, select [STOP], press (⊗) and retry printing. Refer also to the printer's instruction manual for details.
- If the error still persists and printing does not restart, disconnect the USB cable and turn off the camcorder and the printer. After a short while, turn them on again, set the camcorder to **PLAY** (□) mode and restore the connection.

#### WHEN YOU HAVE FINISHED PRINTING

Disconnect the cable from the camcorder and printer and turn off the camcorder.

#### ! IMPORTANT

- The following still images may not be correctly printed with a PictBridge-compatible printer.
  - Images created or changed on a computer and transferred to the memory card.
  - Images recorded with the camcorder but edited on a computer.
  - Images whose file names were changed.
  - Images not recorded with this camcorder.
- Observe the following precautions during printing:
  - Do not turn off the camcorder or the printer.
  - Do not change the position of the  /  switch.
  - Do not disconnect the USB cable.
  - Do not remove the memory card.
- If the message "BUSY" does not disappear, disconnect the USB cable and restore the connection after a short while.

---

---

#### Print Orders

You can mark in advance the still images you want to print and set the desired number of copies as a print order. Later, you can easily print out the print orders by connecting the camcorder to a PictBridge-compatible printer (□ 57). You can set print orders for up to 998 still images.



## Selecting Still Images for Printing (Print Order)



### POINTS TO CHECK

Set the print orders before connecting the USB cable to the camcorder.

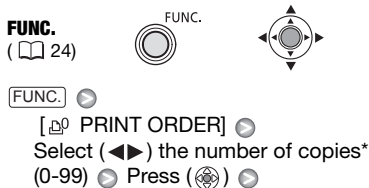

\* To cancel the print order, set the number of copies to 0.

## Printing Still Images Marked with Print Orders



### 1 Connect the camcorder to the printer using the supplied USB cable.

Refer to *PC Connection Diagrams* (page 67).

### 2 Open the print settings menu.



- The print settings menu appears.
- The error message "SET PRINT ORDER" appears if you connect a printer with direct print function and select [PRINT] without having set any print orders beforehand.

### 3 Select (up/down, left/right) [PRINT] and press (center).

Printing starts. The print settings menu disappears when printing is completed.

### NOTES

- Depending on the connected printer, you can change some print settings before step 3 (page 57).
- Cancel Printing/Printing Errors** (page 59).
- Restarting Printing:** Open the print menu as explained in step 2 above. In the print settings menu, select [RESUME]\* and press (center). The remaining images will be printed. Printing cannot be restarted when the print order settings have been changed or if you deleted a still image with print order settings.
- \* If the print order was interrupted after the first still image, this menu option will appear as [PRINT] instead.

## Erasing All Print Orders

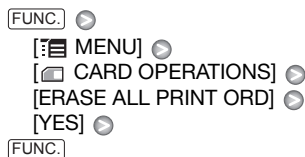



4



## External Connections

This chapter explains step-by-step how to connect your camcorder to an external device such as a TV, VCR, or computer.

### Connecting to a TV or VCR

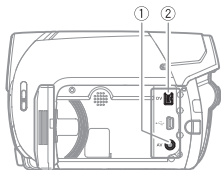

Open the LCD panel to access.



#### ① AV Terminal

Sound from the built-in speaker will be muted while the STV-250N Stereo Video Cable is connected to the camcorder.



#### ② DV Terminal

Check the type and orientation of the terminal and make sure you connect the DV cable properly.

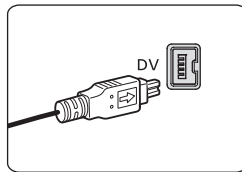
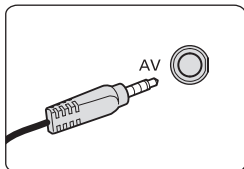

## Connection Diagrams

Turn off all the devices when making the connections and refer also to the instruction manual of the connected device.

Terminal on the Camcorder	Connecting Cable	Terminal on the Connected Device
---------------------------	------------------	----------------------------------

**1** Output connection (signal flow →) to a TV or VCR with AV Terminals.

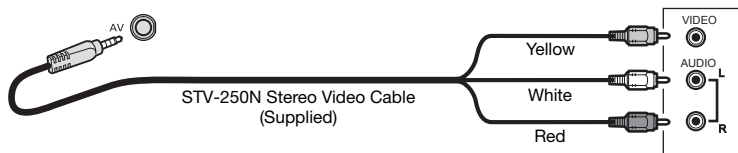

**2** Output connection (signal flow →) to a high-definition TV with a DV (IEEE1394) terminal.

Input connection (signal flow ←) from a TV or other digital video source with a DV (IEEE1394) output.

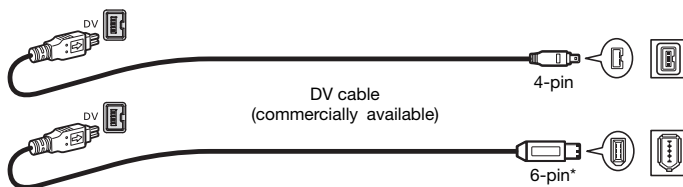

\* Be careful to correctly insert the 6-pin plug into the DV terminal. Inserting it in the wrong direction can result in damage to the camcorder.



---

## Playback on a TV Screen

The quality of the playback picture will vary depending on the connected TV and the type of connection used.



### POINTS TO CHECK

Before making the connections, select the [TV TYPE] setting according to the TV set to which you will connect the camcorder (□ 75).

---

## Connecting

Connect the camcorder to the TV following one of the connection diagrams shown in *Connection Diagrams* (□ 62).

---

## Playback

### 1 Turn on the camcorder and the connected TV or VCR.

On a TV: Select as the video input the same terminal to which you connected the camcorder.

On a VCR: Set the input selector to the external video input (usually labeled LINE IN).

### 2 Start the playback of the movies (□ 36) or still images (□ 52).

### NOTES

- Turn off all the devices before starting the connections.
- We recommend powering the camcorder using the compact power adapter.

---

## Copying your Recordings to an External Video Recorder

You can copy your recordings by connecting the camcorder to a VCR or a digital video device. When recording to a digital video recorder using the DV terminal, you can copy recordings with virtually no generation loss in video and sound quality.



---

## Connecting

Connect the camcorder to a VCR or other analog device using connection type **1**, or to a DVD recorder or other digital recording device using connection type **2**, as shown in *Connection Diagrams* (□ 62).

---

## Recording

- 1 This camcorder: Load the recorded cassette.**
- 2 Connected device: Load a blank cassette or disc and set the device to record pause mode.**
- 3 This camcorder: Locate the scene you wish to copy and pause the playback shortly before the scene.**
- 4 This camcorder: Resume the movie playback.**

When using an analog connection you can include in the copy also the date/time of the original recording (□ 39).
- 5 Connected device: Begin recording when the scene you wish to copy appears. Stop**

recording when copying is complete.

## 6 This camcorder: Stop playback.

### NOTES

- We recommend powering the camcorder using the compact power adapter.
- When recording to a VCR using an analog connection –connection type **1** (□ 62)–, the quality of the edited tape will be lower than the original.
- When recording to a digital video recorder using the DV terminal –connection type **2** (□ 62)–:
  - If the picture does not appear, disconnect the DV cable and restore the connection after a short while or turn the camcorder off and then on again.
  - Proper operation cannot be guaranteed for all digital devices equipped with a DV terminal. If the operation does not work, use the AV terminal.

---

## Digital Video Dubbing

You can input video from other digital video devices and record the input video on the tape in the camcorder.



---

### Connecting

Connect the camcorder to the video input source using the digital connection –connection type **2** (□ 62)– shown in *Connection Diagrams*.

---

### Dubbing

**FUNC.**  
(□ 24)



**1 Load a blank tape in the camcorder and load the recorded (source) tape or disc in the connected device.**

**2 Set the camcorder in record pause mode.**



**3 Connected device: Start the playback.**

In record pause mode and while recording you can check the picture on the camcorder's screen.





- 4 When the scene you wish to record appears, push the joystick (▲) toward ● /|| to begin recording.**

Recording starts.

- 5 While recording, push the joystick (▲) toward ● /|| to record pause.**

In record pause mode, push the joystick (▲) toward ● /|| again to resume recording.

- 6 Push the joystick (▼) toward ■ to stop recording.**

- 7 Connected device: Stop the playback.**

### **! IMPORTANT**

- Blank sections may be recorded as anomalous picture.
- If the picture does not appear, disconnect the DV cable and restore the connection after a short while or turn the camcorder off and then on again.
- Do not connect any devices to the camcorder's USB terminal while an external device is connected to the DV terminal.
- You can only record video signals in DV standard (standard definition, SP or LP mode) from devices carrying the **DV** logo. Note that signals from identically shaped DV (IEEE1394) terminals may be in different video standards.

### **i NOTES**

We recommend powering the camcorder using the compact power adapter.

### **Copyright Signal**

Certain software tapes are copyright protected. If you attempt to play back such tape, "COPYRIGHT PROTECTED PLAYBACK IS RESTRICTED" appears and you will not be able to view the contents of the tape. If you attempt to record from such tape via the DV terminal, "COPYRIGHT PROTECTED DUBBING RESTRICTED" appears and you will not be able to record the contents of the tape.

## Audio Dubbing

You can add sound to a recording using the built-in microphone.



### POINTS TO CHECK

You can only dub audio on tapes recorded in SP mode with [12bit] audio (□ 44). This function is operated with the wireless controller.

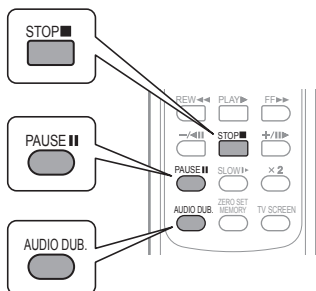

#### 1 Locate the point where you want to start dubbing audio.

Before locating the starting point, you can also set the zero set memory (□ 37) at the point where you want the audio dubbing to end. The camcorder will automatically stop audio dubbing at that point.

#### 2 Start playback and immediately press [PAUSE II].

#### 3 Press [AUDIO DUB].

“AUDIO DUB.” and [PAUSE II] appear.

#### 4 Press [PAUSE II] to begin dubbing.

Speak into the microphone.

#### 5 Press [STOP ■] to stop dubbing.

### IMPORTANT

- Audio dubbing will stop if the tape has a blank section or a section recorded in LP mode or [16bit] 16bit audio.
- The quality of the dubbed sound will not be as good when dubbing audio to a tape that was not recorded with this camcorder or after having dubbed audio over the same scene more than 3 times.

### NOTES

You can connect the camcorder to a TV to check the picture on the TV screen and check the sound through headphones connected to the TV.

### TO SELECT THE AUDIO TRACK FOR PLAYBACK

You can select the audio track that will be played when playing back a tape that was audio dubbed (□ 45).



## Connecting to a Computer

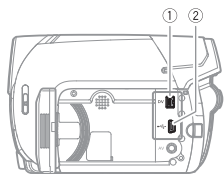

Open the LCD panel to access.



### ① DV Terminal

Check the type and orientation of the terminal and make sure you connect the DV cable properly.



### ② USB Terminal

Use the USB connection to print still images and transfer them to a computer.

## PC Connection Diagrams

Terminal on the Camcorder	Connecting Cable	Terminal on the Connected Device
---------------------------	------------------	----------------------------------

**1** Output connection (signal flow →) to a computer with a DV (IEEE1394) terminal or a DV capture board.

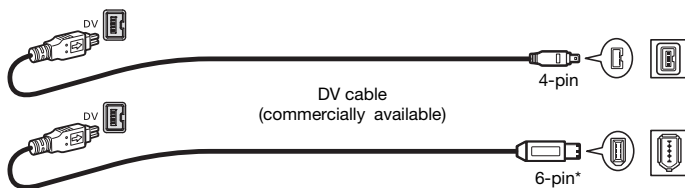

\* Be careful to correctly insert the 6-pin plug into the DV terminal. Inserting it in the wrong direction can result in damage to the camcorder.

**2** Output connection (signal flow →) to a PC or PictBridge compatible printer with a USB port.

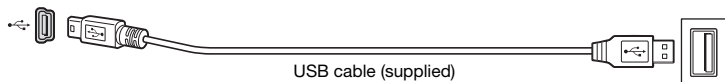

---

## Transferring Video Recordings

You can transfer recordings to a computer using the DV terminal.

---



### Equipment and System Requirements

- A computer equipped with an IEEE1394 (DV) terminal or an IEEE1394 (DV) capturing board.
- A DV cable (commercially available).
- Video editing software.
- The appropriate driver.

A driver is preinstalled on Windows operating systems later than Windows 98 Second Edition and Mac operating systems later than Mac OS 9, and will be installed automatically.

---

### Connecting

- 1 Start the computer.**
- 2 Connect the camcorder to the computer using the DV connection –connection type  (□ 67)– shown in PC Connection Diagrams.**
- 3 Set the camcorder to  mode.**
- 4 Start the video editing software.**  
Refer to the instruction manual of the editing software.

---

### IMPORTANT

- The video transfer may not work correctly depending on the software and the specifications/settings of your computer.
- If the computer freezes while the camcorder is connected to it, disconnect the DV cable and turn off the camcorder and the computer. After a short while, turn them on again, set the camcorder to  mode and restore the connection.
- Before connecting the camcorder to the computer using a DV cable, make sure that the camcorder and computer are not connected with a USB cable, and that no other IEEE1394 device is connected to the computer.
- Depending on the video editing software, you may need to set the **POWER** switch on the camcorder to a mode other than PLAY. Refer to the instruction manual of the editing software.

---

### NOTES

- We recommend powering the camcorder using the compact power adapter.
- Refer also to the instruction manual of the computer.
- The programs ZoomBrowser EX and Image Browser included with the supplied CD-ROM can only be used to transfer still images recorded on the memory card. Video recordings on the tape cannot be transferred to the computer using the software included with the supplied CD-ROM.



---

## Transferring Photos – Direct Transfer

With the supplied USB cable and software (on the **DIGITAL VIDEO Solution Disk** CD-ROM) you can easily transfer still images to a computer.

### Preparations

The first time you connect the camcorder to the computer, you need to install the software and set the auto-launch setting. From the second time on, just connect the camcorder to the computer using the USB cable to transfer images.

#### 1 Install the supplied Digital Video Software.

Refer to the installation guide (separate leaflet included with the CD-ROM).

#### 2 Set the camcorder to mode.



#### 3 Connect the camcorder to the computer using the USB cable.

Refer to *PC Connection Diagrams* (□ 67).

#### 4 Set the auto-launch setting.

- See *When Connecting the Camcorder to a Computer* (Windows) or *Auto-downloading* (Macintosh) in the *Digital Video Software* instruction manual (electronic version on PDF file).
- The direct transfer menu appears on the camcorder's screen.

### IMPORTANT

- Observe the following precautions when the CARD access indicator is on or flashing. Failing to do so may result in permanent data loss.
  - Do not open the memory card slot cover and do not remove the memory card.
  - Do not disconnect the USB cable.
  - Do not turn off the camcorder or the computer.
  - Do not change the position of the  /  switch or the operating mode.
- Operation may not work correctly depending on the software and the specifications/settings of your computer.
- If you wish to use the image files you transferred from the memory card on your computer, make copies of them first. Use the copied files, retaining the originals.

### NOTES

- We recommend powering the camcorder using the compact power adapter.
- Refer also to the computer's instruction manual.
- Users of Windows Vista, Windows XP and Mac OS X:  
Your camcorder is equipped with the standard Picture Transfer Protocol (PTP) allowing you to download still images (JPEG only) simply by connecting the camcorder to a computer using the USB cable, without having to install the supplied software.

## Transferring Images



### Automatic Transfer Options

All the relevant still images will be transferred to the computer in one batch and their thumbnails will be displayed on the computer.

[CAMERA] ALL IMAGES]
Transfers all still images.
[CAMERA] NEW IMAGES]
Transfers only those still images that have not yet been transferred to the computer.
[CAMERA] TRANSFER ORDERS]
Transfers still images marked with transfer orders (23 71).

### Manual Transfer Options

You can select the still image(s) to transfer.

[CAMERA] SELECT & TRANSFER]
Select the still image(s) to transfer.
[CAMERA] WALLPAPER]
Select a still image still image and set it as your computer's desktop background.



### AUTOMATIC TRANSFER OPTIONS

- 1 Select (▲▼) a transfer option and press (⊗).
- 2 Select (◀▶) [OK] and press (⊗).
  - The images are transferred and displayed on the computer.
  - The camcorder returns to the transfer menu once the transfer is completed.
  - To cancel the transfer, select (◀▶) [CANCEL] and press (⊗), or press [FUNC.].

### MANUAL TRANSFER OPTIONS

- 1 Select (▲▼) a transfer option and press (⊗).
- 2 Select (◀▶) the image you wish to transfer and press (⊗).  
[CAMERA] SELECT & TRANSFER]: Repeat this step to select other still images to transfer.
- 3 Press [FUNC.] to return to the transfer menu.



## NOTES

When the camcorder is connected to the computer and the image selection screen is displayed, press **[FUNC.]** to return to the transfer menu.

---

## Transfer Orders

You can mark in advance the still images you want to transfer to the computer as transfer orders. You can set transfer orders for up to 998 still images.



---

## Selecting Still Images to Transfer (Transfer Order)

### POINTS TO CHECK

Set the transfer orders before connecting the camcorder to the computer.

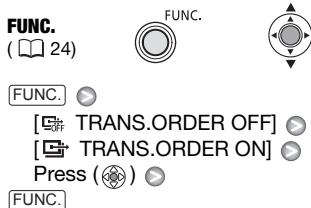

\* To cancel a transfer order, select **[TRANS. ORDER OFF]** instead.

---

## Erasing All Transfer Orders

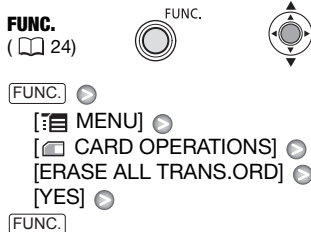



# Additional Information

This chapter contains troubleshooting advice, screen messages, handling and maintenance tips, and other information.

## Appendix: Menu Options Lists

Menu items not available appear grayed out. For details about how to select an item, refer to *Using the Menus* (p. 24). For details about each function, see the reference page. Menu options without a reference page are explained below the tables.

### FUNC. Menu

Menu item	Setting options	CAMERA		PLAY		📖
Recording programs <sup>1</sup>	[ <b>P PROGRAM AE</b> ], [  PORTRAIT ], [  SPORTS ], [  NIGHT ], [  SNOW ], [  BEACH ], [  SUNSET ], [  SPOTLIGHT ], [  FIREWORKS ]	●	●	–	–	40
White balance <sup>1</sup>	[ <b>AUTO</b> ], [  DAYLIGHT ], [  TUNGSTEN ], [  SET ]	●	●	–	–	47
Image effects <sup>1</sup>	[ <b>IMAGE EFFECT OFF</b> ], [  VIVID ], [  NEUTRAL ], [  SOFT SKIN DETAIL ]	●	●	–	–	48
LCD video light	[ <b>LCD LIGHT OFF</b> ], [  LCD LIGHT ON ]	●	●	–	–	43
Digital effects	[ <b>D.EFFECT OFF</b> ], [  FADE-T ], [  WIPE ], [  BLK&WHT ], [  SEPIA ], [  ART ], [  MOSAIC ] [ <b>D.EFFECT OFF</b> ], [  BLK&WHT ]	● <sup>1</sup>	–	●	–	48
Still image size/quality	Size: [ <b>L 1152x864</b> ], [ S 640x480 ] Quality: [  SUPER FINE ], [  FINE ], [  NORMAL ]	–	●	–	–	51
[SPEAKER VOLUME]	–.....■■■■■■■■■■+	–	–	●	–	36





## FUNC. Menu (cont.)

Menu item	Setting options	CAMERA		PLAY		Page
[REC PAUSE]	Press (  ) to enter the record pause mode.	-	-	●	-	64
[END SEARCH]	Press (  ) to search.	-	-	●	-	38
[SLIDESHOW]	Press (  ) to start.	-	-	-	●	53
[IMAGE ERASE]	[CANCEL], [ERASE]	-	● <sup>2</sup>	-	-	54
Still image protection	[  PROTECT OFF], [  PROTECT ON]	-	● <sup>2</sup>	-	●	55
[PRINT ORDER]	[  0] - [  99] COPIES	-	-	-	●	59
Transfer order	[  TRANS.ORDER OFF], [  TRANS.ORDER ON]	-	-	-	●	71

<sup>1</sup> Option available only when the mode switch is set to .

<sup>2</sup> This option will appear only when you press within the time set for the [REVIEW] option (or immediately after recording the still image, if set to [ OFF]).

## CAMERA SETUP

Menu item	Setting options	CAMERA		Page
[SHUTTER] <sup>1</sup>	[ <b>AUTO</b> ], [1/60], [1/100], [1/250], [1/500], [1/1000], [1/2000] [ <b>AUTO</b> ], [1/60], [1/100], [1/250]	●	-	42
[A.SL SHUTTER] <sup>2</sup>	[ <b>ON</b> ], [ <b>OFF</b> ]	●	●	
[ZOOM TYPE]	[ <b>37x</b> OPTICAL ], [ <b>48x</b> <b>ADVANCED</b> ] <sup>4</sup> , [ <b>2000x</b> DIGITAL ]	●	●	33
[ZOOM SPEED]	[ <b>VARIABLE</b> ], [ <b>SPEED 3</b> ], [ <b>SPEED 2</b> ], [ <b>SPEED 1</b> ]	●	●	33
[FOCUS PRI.] <sup>3</sup>	[ <b>ON:AI AF</b> ], [ <b>ON: CENTER</b> ], [ <b>OFF</b> ]	-	●	55
[REVIEW]	[ <b>OFF</b> ], [ <b>2sec</b> ], [ <b>4sec</b> ], [ <b>6sec</b> ], [ <b>8sec</b> ], [ <b>10sec</b> ]	-	●	-
[IMG STAB] <sup>3</sup>	[ <b>ON</b> ], [ <b>OFF</b> ]	●	-	-
[WIDESCREEN]	[ <b>ON</b> ], [ <b>OFF</b> ]	●	-	-
[SELF TIMER]	[ <b>ON</b> ], [ <b>OFF</b> ]	●	●	43

<sup>1</sup> Option available only when the recording program is set to [P PROGRAM AE].

<sup>2</sup> Option available when the mode switch is set to EASY or P (only when the recording program is set to [P PROGRAM AE]).

<sup>3</sup> Option available only when the mode switch is set to P.

<sup>4</sup> [55 ADVANCED] when [WIDESCREEN] is set to [OFF OFF].

**[A.SL SHUTTER]:** The camcorder automatically uses slow shutter speeds to obtain brighter recordings in places with insufficient lighting.

- The camcorder uses shutter speeds down to 1/30 (1/15 in CAMERA mode).
- If a trailing afterimage appears, set the slow shutter to [OFF OFF].
- If  (camcorder shake warning) appears, we recommend stabilizing the camcorder, for example, by mounting it on a tripod.

**[REVIEW]:** Selects the time to display a still image after it has been recorded.

- You can erase (□ 54) or protect (□ 55) the image if you press [FUNC.] while you are reviewing the image (or immediately after recording it, if set to [OFF OFF]).



**[IMG STAB]:** The image stabilizer compensates for camcorder shake even at full telephoto.

- The image stabilizer is designed to compensate for a normal degree of camcorder shake.
- The image stabilizer may not be effective when recording in dark places with [A.SL SHUTTER] set to [ON ON] or using the [NIGHT] recording program.
- The image stabilizer cannot be turned off when the mode switch is set to EASY.
- We recommend setting the image stabilizer to [OFF OFF] when using a tripod.

**[WIDESCREEN]:** The camcorder uses the full width of the image sensor providing high-resolution 16:9 recordings.

- Since the screens on the camcorder have an aspect ratio of 16:9, recordings with a 4:3 aspect ratio will appear in the center of the screen with black sidebars.
- **Playing back a widescreen recording:** TV sets compatible with the Video ID-1 system will automatically switch to wide (16:9) mode. Otherwise, change the aspect ratio of the TV manually. To play back on a TV with normal aspect ratio (4:3) change the [TV TYPE] setting accordingly (□ 75).

## VCR SETUP

Menu item	Setting options	CAMERA	PLAY	
				
[REC MODE]	[SP STD PLAY], [LP LONG PLAY]	●	●	–
[TV TYPE]	[4:3 NORMAL TV], [16:9 WIDE TV]	●	●	–



**[REC MODE]:** Select the video recording mode.

- Recording in LP mode extends the available recording time on the tape 1.5 times.
- Depending on the condition of the tape (long usage, imperfections, etc.) you may notice some video anomalies (blocky video artifacts, banding, etc.) in the playback picture when playing back recordings made in LP mode. We recommend using the SP mode for important recordings.
- Audio cannot be dubbed on tapes recorded in LP mode.
- If you make recordings in both SP and LP modes on the same tape, during playback you may notice some video anomalies in the picture at the point where the recording mode changes.
- When playing back in this camcorder tapes recorded in LP mode with other devices or vice versa, you may notice some anomalies in the playback picture or the sound may stop briefly.

**[TV TYPE]:** In order to display the picture in full and in the correct aspect ratio, select the setting according to the type of television to which you will connect the camcorder.

[NORMAL TV]: TV sets with 4:3 aspect ratio.

[WIDE TV]: TV sets with 16:9 aspect ratio.

## 🔊 AUDIO SETUP

Menu item	Setting options	CAMERA	PLAY	📖
[OUTPUT CH]	[  L/R], [  L/L], [  R/R]	–	●	44
[WIND SCREEN]	[  AUTO], [  OFF  OFF]	● <sup>1</sup>	●	–
[12bit AUDIO]	[  ST-1 STEREO1], [  ST-2 STEREO2], [ 1:1 MIX/FIXED], [  MIX/VAR.]	–	●	45
[MIX BALANCE]	ST-1  ST-2	–	●	–
[AUDIO MODE]	[  16bit], [  12bit]	●	–	44

<sup>1</sup> Option available only when the mode switch is set to .



**[WIND SCREEN]:** The camcorder automatically reduces the background sound of wind when recording outdoors.

- The wind screen cannot be turned off when the mode switch is set to **EASY**.













**[MIX BALANCE]:** When [12bit AUDIO] is set to [ MIX/VAR.], adjust (◀▶) the sound balance with the joystick.

- The camcorder will retain the audio balance adjustment, however if you turn off the camcorder, [12bit AUDIO] will be reset to [ STEREO1].

 CARD OPERATIONS

Menu item	Setting options	PLAY	
			
[ERASE ALL PRINT ORD]	[NO], [YES]	●	60
[ERASE ALL TRANS.ORD]	[NO], [YES]	●	71
[ERASE ALL IMAGES]	[NO], [YES]	●	54
[INITIALIZE]	[NO], [YES]	●	56

 DISPLAY SETUP

Menu item	Setting options	CAMERA		PLAY		
						
[BRIGHTNESS]		●	●	●	●	–
[BACKLIGHT]	[  <b>NORMAL</b> ] <sup>1</sup> , [  BRIGHT]	●	●	●	●	28
[TV SCREEN]	[ <b>ON ON</b> ], [ <b>OFF OFF</b> ]	●	●	–	–	–
	[ <b>ON ON</b> ], [ <b>OFF OFF</b> ]	–	–	●	●	
[MARKERS]	[ <b>OFF OFF</b> ], [  LEVEL ], [  GRID ]	●	–	–	–	–
[DISPLAYS]	[ <b>ON ON</b> ], [ <b>OFF OFF</b> <PLAYBK> ]	–	–	●	●	–
[6SEC.DATE]	[ <b>ON ON</b> ], [ <b>OFF OFF</b> ]	–	–	●	–	–
[DATA CODE]	[ <b>OFF OFF</b> ], [  DATE ], [  TIME ], [  DATE & TIME ]	–	–	●	●	39
[LANGUAGE] <sup>2</sup>	<b>Language Set A:</b> [DEUTSCH], [ <b>ENGLISH</b> ], [ESPAÑOL], [FRANÇAIS], [ITALIANO], [POLSKI], [РУССКИЙ], [简体中文], [日本語] <b>Language Set B:</b> [ENGLISH], [简体中文], [繁體中文], [한국어]	●	●	●	●	26
[DEMO MODE]	[ <b>ON ON</b> ], [ <b>OFF OFF</b> ]	●	●	–	–	–

<sup>1</sup> The default setting is [ BRIGHT] when you power the camcorder using the compact power adapter.

<sup>2</sup> The list of languages available depends on the region of purchase.

**[BRIGHTNESS]:** Adjust (◀▶) the brightness of the LCD display with the joystick.

- Changing the brightness of the LCD display does not affect that of the viewfinder or the recordings.



**[TV SCREEN]:** When set to [ **ON** ON], the camcorder's on-screen displays will appear also on the screen of a connected TV or monitor.

When the date and time are displayed on the camcorder's screen they will also appear on a connected TV regardless of the [TV SCREEN] setting. Turn off the date/time display with the [DATA CODE] setting (□ 39).

**[MARKERS]:** You can display a grid or a horizontal line at the center of the screen. Use the markers as a reference to make sure your subject is framed correctly (vertically and/or horizontally).

- Using the markers will not affect the recordings on the tape.

**[DISPLAYS]:** You can hide the on-screen displays to show only the playback picture on the full screen.

- Tape operation displays appear for 2 seconds.
- Warning messages, the data code (if activated), and displays on the index screen will appear regardless of the setting.
- All on-screen displays will appear while the playback image is magnified or a digital effect is activated.

**[6SEC.DATE]:** When you start playing back a tape or when the date of the recording changes, the date and time will be displayed for 6 seconds.

**[DEMO MODE]:** The demonstration mode displays the camcorder's main features. It starts automatically when the camcorder is powered with the power adapter if you leave it turned on without loading a recording media for more than 5 minutes.

- To cancel the demo mode once it started, press any button, turn off the camcorder or insert a videocassette.

## 🔊 SYSTEM SETUP

Menu item	Setting options	CAMERA		PLAY		📖
[WL.REMOTE]	[ <b>ON</b> ON], [ <b>OFF</b> OFF	●	●	●	●	–
[BEEP]	[ <b>HIGH VOLUME</b> ], [ <b>LOW VOLUME</b> ], [ <b>OFF</b> OFF]	●	●	●	●	–
[POWER SAVE]	[ <b>ON</b> ON], [ <b>OFF</b> OFF]	●	●	–	–	–
[FILE NOS.]	[ <b>RESET</b> ], [ <b>CONTINUOUS</b> ]	–	●	–	–	–
[FIRMWARE]	–	–	–	–	●	–

**[WL. REMOTE]:** Allows the camcorder to be operated with the wireless controller.

**[BEEP]:** A beep will accompany some operations like turning on the camcorder, the self-timer countdown, etc. It also serves as a warning beep under unusual conditions.

**[POWER SAVE]:** In order to save power when the camcorder is powered by a battery pack, it will automatically shut off if left without any operation for 5 minutes. Approximately 30 seconds before the camcorder shuts off, the message “⚠️ AUTO POWER OFF” will appear.

**[FILE NOS.]:** Select the image numbering method to be used when you insert a new memory card.

Images are automatically assigned consecutive image numbers from 0101 to 9900, and stored in folders containing up to 100 images. Folders are numbered from 101 to 998.

**[🔄 RESET]:** Image numbers will restart from 101-0101 every time you insert a new memory card.

**[▶️ CONTINUOUS]:** Image numbers will continue from the number following that of the last image recorded with the camcorder.

- If the memory card you insert already contains an image with a larger number, a new image will be assigned a number one higher than that of the last image on the memory card.
- We recommend using the [▶️ CONTINUOUS] setting.

**[FIRMWARE]:** You can verify the current version of the camcorder’s firmware. This menu option is usually grayed out.

## 🕒 DATE/TIME SETUP

Menu item	Setting options	CAMERA		PLAY		📖
		🕒	📷	🕒	📷	
[T.ZONE DST]	List of world time zones.	●	●	●	●	26
[DATE/TIME]	–	●	●	●	●	27
[DATE FORMAT]	[Y.M.D (2008.1.1 AM 12:00)], [M.D,Y (JAN. 1, 2008 12:00 AM)], [D.M.Y (1.JAN.2008 12:00 AM)]	●	●	●	●	–

**[DATE FORMAT]:** Changes the date format for on-screen displays and for date printing.



## Troubleshooting

If you have a problem with your camcorder, refer to this section. Consult your dealer or a Canon Service Center if the problem persists.

### Power Source

---

The camcorder will not turn on or it turns off by itself.

The cassette compartment cover will not open or it stops halfway while you insert or remove a tape.

The LCD/viewfinder switches on and off.

- Battery pack is exhausted. Replace or charge the battery pack (□□ 19).
- Attach the battery pack correctly.
- Use the compact power adapter.

The charge indicator flashes rapidly.

-  (one flash at 0.5-second intervals)

Charging has stopped because the compact power adapter or the battery pack is faulty. Consult a Canon Service Center.

-  (two quick flashes at 1-second intervals)

Battery pack at least 50% charged (□□ 20). This is not a malfunction.

Battery pack will not charge.

- Charge the battery pack in temperatures between 0 °C and 40 °C (32 °F and 104 °F).
- Battery packs become hot with use and may not charge. When the battery pack is outside the charging temperature range, the CHARGE indicator will flash irregularly. The charging will start once the battery pack temperature is below 40 °C (104 °F).
- The battery pack is damaged. Use a different battery pack.
- If you connect a faulty power adapter or battery pack, the CHARGE indicator flashes approx. twice per second and the charging stops.
- Check that the compact power adapter is correctly connected to the camcorder.

### Recording/Playback

---

Buttons will not work.

- Turn on the camcorder.
- Load a cassette (□□ 29).

Abnormal characters appear on the screen. The camcorder does not operate properly.

- Disconnect the power source and reconnect it after a short time. If the problem still persists, disconnect all power sources (including the battery pack and the backup battery). This will reset all the camcorder's settings.

 flashes on the screen.

- Load a cassette (□□ 29).

 flashes on the screen.

- Battery pack is exhausted. Replace or charge the battery pack (□ 19).

 flashes on the screen.

- Condensation is detected. Refer to *Condensation* (□ 89).

**“REMOVE THE CASSETTE” appears on the screen.**

- Remove the cassette and reinsert it (□ 29).

**The wireless controller will not work.**

- Set [WL.REMOTE] to [ON] (□ 77).
- The battery of the wireless controller is exhausted. Replace the battery (□ 21).

**Video noise appears on screen.**

- When using the camcorder in a room where a plasma TV is located, keep a distance between the camcorder and the plasma TV.

**Video noise appears on the TV screen.**

- When using the camcorder in a room where a TV is located, keep a distance between the compact power adapter and the power or antenna cables of the TV.

**The tape stops during record pause or playback pause.**

- To protect the tape and video heads, the camcorder will enter the stop mode (■) if left in playback pause (▶||) or record pause (●||) mode for 4 minutes 30 seconds. To resume the operation press Start/Stop (when recording) or push the joystick (▲) toward ▶/|| (during playback).

## Recording

---

**Image will not appear on the screen.**

- Set the camcorder to CAMERA (□ 31).

**“SET THE TIME ZONE, DATE AND TIME” appears on the screen.**

- Set the time zone, date and time (□ 26).
- Replace the backup lithium battery and set the time zone, date and time (□ 21).

**Pressing Start/Stop will not start recording.**

- Set the camcorder to CAMERA (□ 31).
- Load a cassette (□ 29).
- Tape reached the end (“END” appears on the screen). Rewind the tape or replace the cassette (□ 29).
- Cassette is protected ( flashes on the screen). Change the position of the protect switch (□ 87).

**Camcorder will not focus.**

- Autofocus does not work on that subject. Focus manually (□ 45).
- If you are using the viewfinder, adjust it with the dioptic adjustment lever (□ 32).
- Lens is dirty. Clean the lens with a soft lens-cleaning cloth (□ 89). Never use tissue paper to clean the lens.

**Sound is distorted.**

- When recording near loud sounds (such as fireworks or concerts), sound may become distorted.

**Viewfinder picture is blurred.**

- Adjust the viewfinder with the dioptic adjustment lever (□ 32).





## Playback

---

During playback there is video noise.

- Video heads are dirty. Clean the video heads (□□ 2).

Playback does not start.

- Load a cassette (□□ 29).
- Set the camcorder to  (□□ 36).
- Tape reached the end ("□□ END" appears on the screen). Rewind the tape (□□ 29).

No sound from the built-in speaker.

- Open the LCD panel.
- Speaker volume is turned off. Adjust the volume with the [SPEAKER VOLUME] setting (□□ 36).

Image will not appear on the TV screen.

- Check again that the camcorder is properly connected to the TV (□□ 62).

Tape is running, but image will not appear on the TV screen.

- TV/VIDEO selector on the TV is not set to VIDEO. Set the selector to VIDEO (□□ 63).
- Video heads are dirty. Clean the video heads (□□ 2).
- You attempted to play back or dub a copyright protected tape (□□ 65). Stop playback/dubbing.

## Memory Card Operation

---

Memory card cannot be inserted.

- Memory card is not facing the correct direction. Turn the memory card over and reinsert it (□□ 30).

Cannot record on the memory card.

- Memory card is full. Erase still images (□□ 54) to free some space or replace the memory card.
- Memory card was not initialized. Initialize the memory card (□□ 56).
- The folder and file numbers have reached their maximum value. Set [FILE NOS.] to [RESET] (□□ 78) and insert a new memory card.

Memory card cannot be played back.



- Set the camcorder to  (□□ 52).

Image cannot be erased.

- Image is protected. Cancel the protection (□□ 55).
- The write-protect switch on an SD or SDHC memory card is set to prevent accidental erasure. Change the position of the write-protect switch.

 flashes in red.

- A memory card error occurred. Turn off the camcorder. Remove and reinsert the memory card. Initialize the memory card (□□ 56) if flashing persists.

## Printing

---

The printer is not operating even though the camcorder and printer are correctly connected.

- Disconnect the USB cable and turn off the camcorder and the printer. After a short while, turn them on again, set the camcorder to  mode and restore the connection.

## Editing

---

Cannot record with this camcorder video input from an external video device connected using a DV cable.

- Wrong signal standard. Refer also to the instruction manual of the connected device.

---



---

## List of Messages (in alphabetical order)

### CANNOT TRANSFER!

- You attempted to transfer a still image that cannot be displayed with this camcorder.

### CARD ERROR

- A memory card error occurred. The camcorder cannot record or display the image. The error may be temporary. If the message disappears after 4 seconds and  flashes red, turn the camcorder off, remove the card and reinsert the card. If  changes to green, you can continue recording/playback.

### CARD FULL

- Memory card is full. Erase some images ( 54) to free some space or replace the memory card.

### CHANGE THE BATTERY PACK

- Battery pack is exhausted. Replace or charge the battery pack ( 19).

### CHECK THE CASSETTE [AUDIO MODE]

- You attempted to dub audio ( 66) on a tape recorded with an audio mode other than [  12bit ].

### CHECK THE CASSETTE [BLANK]

- You attempted to dub audio ( 66) on a tape with a blank section.

### CHECK THE CASSETTE [INCORRECT TAPE SPECIFICATION]

- You attempted to dub audio ( 66) on a tape recorded in HD (high definition) standard.

### CHECK THE CASSETTE [REC MODE]

- You attempted to dub audio ( 66) on a tape recorded in a recording mode other than SP.

### CHECK THE INPUT

- The DV cable is not correctly connected to the DV terminal ( 62), or the connected digital device is turned off.
- The video input signal is in a different television system (PAL or SECAM).

### CONDENSATION HAS BEEN DETECTED

- Condensation has been detected in the camcorder ( 89).

### CONDENSATION HAS BEEN DETECTED REMOVE THE CASSETTE

- Condensation has been detected in the camcorder ( 89). Remove the cassette.

### COPYRIGHT PROTECTED DUBBING RESTRICTED

- You attempted to dub a copyright protected tape ( 65).

**COPYRIGHT PROTECTED PLAYBACK IS RESTRICTED**

- You attempted to play back a copyright protected tape (□□ 65).

**HEADS DIRTY, USE CLEANING CASSETTE**

- Video heads are dirty. Clean the video heads (□□ 2).

**INCORRECT TAPE SPECIFICATION PLAYBACK IS RESTRICTED**

- You attempted to play back a tape recorded in a different television system (PAL or SECAM) or in a recording standard not supported by this camcorder.

**INPUT SIGNAL NOT SUPPORTED**

- The digital device connected with the DV cable is incompatible with the camcorder.

**NAMING ERROR**

- The folder and file numbers have reached their maximum value. Set the [FILE NOS.] option to [RESET] and erase all the images on the memory card (□□ 54) or initialize it (□□ 56).

**NO CARD**

- There is no memory card in the camcorder (□□ 30).

**NO IMAGES**

- No images are recorded on the memory card.

**REMOVE THE CASSETTE**

- Camcorder stopped operating to protect the tape. Remove the cassette and reinsert it (□□ 29).

**SET THE TIME ZONE, DATE AND TIME**

- You have not set the time zone, date and time. This message appears each time you turn the power on until you set the time zone, date and time (□□ 26).

**TAPE END**

- Tape reached the end. Rewind the tape or replace the cassette.

**THE CARD IS SET FOR ERASURE PREVENTION**

- The write-protect switch on an SD or SDHC memory card is set to prevent accidental erasure. Change the position of the write-protect switch.

**THE TAPE IS SET FOR ERASURE PREVENTION**

- Cassette is protected. Replace the cassette or change the position of the protect switch (□□ 87).

**THIS IMAGE CANNOT BE RECORDED**

- Some analog images cannot be recorded on the memory card depending on the signal.

**TOO MANY STILL IMAGES DISCONNECT USB CABLE**

- Disconnect the USB cable and decrease the number of still images on the memory card to less than 1,800. If a dialog appeared on the computer screen, close it and then restore the connection.

**TRANSFER ORDER ERROR**

- You attempted to set more than 998 transfer orders (□□ 71).

**UNIDENTIFIABLE IMAGE**

- The image file is corrupted or it was saved using a compression method other than that compatible with this camcorder (JPEG).

---

---

## Direct Print Related Messages

About Canon PIXMA/SELPHY DS Printers: If the printer's error indicator flashes or an error message appears on the printer's operation panel, refer to the printer's instruction manual.

### **CANNOT PRINT!**

- You attempted to print an image that was recorded with another camcorder, with a different compression, or was edited on a computer.

### **COMMUNICATION ERROR**

- The printer is experiencing a data transfer error. Cancel printing. Disconnect the USB cable and turn off the camcorder and the printer. After a short while, turn them on again, set the camcorder to **PLAY** mode and restore the connection. If you attempted to print from a memory card that contains a large number of images, reduce the number of images.

### **COULD NOT PRINT X IMAGES**

- You attempted to use the print order settings to print X images that were recorded with another camcorder, with a different compression or were edited on a computer.

### **FILE ERROR**

- You attempted to print an image that was recorded with another camcorder, with a different compression, or was edited on a computer.

### **HARDWARE ERROR**

- Cancel printing. Turn off the printer and turn it back on. Check the printer status. If the printer is equipped with a battery, it might be exhausted. In such case, turn off the printer, replace the battery and turn it back on.

### **INCOMPATIBLE PAPER SIZE**

- The paper settings of the camcorder conflict with the printer's settings.

### **INK ABSORBER FULL**

- Select [CONTINUE] to resume printing. Contact a Canon Service Center (refer to the list included with the printer) to replace the ink absorber.

### **INK ERROR**

- There is a problem with the ink.

### **LOW INK LEVEL**

- The ink cartridge needs to be replaced soon. Select [CONTINUE] to restart printing.

### **NO INK**

- The ink cartridge is not inserted or is out of ink.

### **NO PAPER**

- Paper is not correctly inserted or there is no paper.

### **NO PRINTHEAD**

- No print head is installed in the printer or the print head is defective.



#### **PAPER ERROR**

- There is a problem with the paper. The paper is not correctly loaded or the paper size is wrong.
- If the paper output tray is closed, open it to print.

#### **PAPER JAM**

- The paper jammed during printing. Select [STOP] to cancel printing. After removing the paper, set some paper again and retry printing.

#### **PAPER LEVER ERROR**

- Paper lever error occurred. Adjust the paper selection lever to the proper position.

#### **PRINT ERROR**

- Cancel printing, disconnect the USB cable and turn off the printer. After a while, turn the printer back on and reconnect the USB cable. Check the printer status.

#### **PRINT ORDER ERROR**

- You attempted to set more than 998 still images in the print order (□□ 59).

#### **PRINTER COVER OPEN**

- Close the printer cover securely.

#### **PRINTER ERROR**

- Cancel printing. Turn the printer off and then on again. Check the printer status. If the error still persists, refer to the printer's instruction manual and contact the appropriate customer support center or service center.

#### **PRINTER IN USE**

- The printer is in use. Check the printer status.

#### **SET PRINT ORDER**

- No still image on the memory card has been marked with a print order.

## Handling Precautions

### Camcorder

- Do not carry the camcorder by the LCD panel. Be careful when closing the LCD panel.
- Do not leave the camcorder in places subject to high temperatures (like the inside of a car under direct sunlight), or high humidity.
- Do not use the camcorder near strong electromagnetic fields such as above TVs, near plasma TVs or mobile phones.
- Do not point the lens or viewfinder at strong light sources. Do not leave the camcorder pointed at a bright subject.
- Do not use or store the camcorder in dusty or sandy places. The camcorder is not waterproof – avoid also water, mud or salt. If any of the above should get into the camcorder it may damage the camcorder and/or the lens.
- Be careful of heat generated by lighting equipment.
- Do not disassemble the camcorder. If the camcorder does not function properly, consult qualified service personnel.
- Handle the camcorder with care. Do not subject the camcorder to shocks or vibration as this may cause damage.

### Battery Pack

#### **DANGER!**

#### **Treat the battery pack with care.**

- Keep it away from fire (or it might explode).
  - Do not expose the battery pack to temperature higher than 60 °C (140 °F). Do not leave it near a heater or inside a car in hot weather.
  - Do not try to disassemble or modify it.
  - Do not drop or knock it.
  - Do not get it wet.
- 
- Charged battery packs continue to discharge naturally. Therefore, charge them on the day of use, or the day before, to ensure a full charge.
  - Attach the terminal cover whenever a battery pack is not in use. Contact with metallic objects may cause a short circuit and damage the battery pack.
  - Dirty terminals may cause a poor contact between the battery pack and the camcorder. Wipe the terminals with a soft cloth.
  - Since storing a charged battery pack for a long time (about 1 year) can shorten its lifecycle or affect performance, we recommend to discharge the battery pack fully and to store it in a dry place at temperatures no higher than 30 °C (86 °F). If you do not use the battery pack for long periods, charge and discharge it fully at least once a year. If you have more than one battery pack, perform these precautions at the same time for all battery packs.



- Although the battery pack's operating temperature range is from 0 °C to 40 °C (32 °F to 104 °F), the optimal range is from 10 °C to 30 °C (50 °F to 86 °F). At cold temperatures, performance will temporarily decline. Warm it in your pocket before use.
- Replace the battery pack if the usable time after full charge diminishes substantially at normal temperatures.

### About the battery terminal cover

The battery terminal cover has a [ ]-shaped hole. This is useful when you wish to differentiate between charged and uncharged battery packs.

Back side of the battery pack

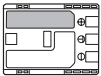

Terminal cover attached



Charged



Uncharged

---

## Cassette

- Rewind tapes after use. A slack or damaged tape may cause video problems and/or audio distortions during playback.
- Return cassettes to the case and store them upright. Rewind tapes from time to time if they are stored for a long time.

- Do not leave the cassette in the camcorder after use.
- Do not use spliced tapes or nonstandard cassettes as they may damage the camcorder.
- Do not use tapes that have been jammed as video heads may become dirty.
- Do not insert anything into the small holes of the cassette, or cover them with cellophane tape.
- Handle cassettes with care. Do not drop or subject them to severe impact as this may damage the cassettes.
- With cassettes equipped with a memory function, metal plated terminals may become dirty with use. Clean the terminals with a cotton swab after about 10 times of removing and reinserting the cassette. The memory function is not supported by the camcorder.

### Protecting Tapes from Accidental Erasure

To protect your recordings from accidental erasure, slide the tab on the cassette to SAVE or ERASE OFF.

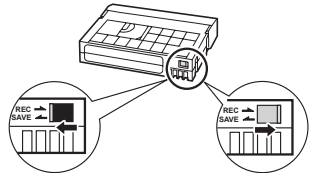

---

---

## Memory Card

- We recommend saving backups of memory card images on your computer. Image data may be corrupted or lost due to memory card defects or exposure to static electricity. Canon makes no warranties for corrupted or lost data.
- Do not turn off the camcorder, disconnect the power source or remove the memory card while the CARD access indicator is flashing.
- Do not use memory cards in places subject to strong magnetic fields.
- Do not leave memory cards in places subject to high humidity and high temperature.
- Do not disassemble, bend, drop, or subject memory cards to shocks and do not expose them to water.
- Do not touch or expose the terminals to dust or dirt.
- Check the direction before inserting the memory card. Forcing a memory card into the slot if it is not correctly oriented may damage the memory card or the camcorder.
- Do not attach any labels or stickers on the memory card.
- When you erase image files or initialize the memory card, only the file allocation table is altered and the data itself is not actually deleted. Take the necessary precautions when you dispose of the memory card, for example by physically damaging it to prevent the leakage of private data.

---

---

## Lithium Button Battery

### WARNING!

- The battery used in this device may present a fire or chemical burn hazard if mishandled.
- Do not disassemble, modify, immerse in water, heat above 100 °C (212 °F) or incinerate the battery.
- Backup battery: Replace with a CR1616 battery made by Panasonic, Hitachi Maxell, Sony, Toshiba, Varta or Renata. Use of other batteries may present a risk of fire or explosion.
- Lithium battery for the wireless controller: Replace with a CR2025 battery made by Panasonic, Hitachi Maxell, Sony, Sanyo, or with Duracell2025. Use of other batteries may present a risk of fire or explosion.
- Do not insert the battery into the mouth. If swallowed, seek medical assistance immediately. The battery case may break and the battery fluids may cause internal damage.
- Keep the battery out of the reach of children.
- Do not recharge, short-circuit or insert the battery in the wrong direction.
- Dispose of the used battery according to applicable recycling regulations.

- Do not pick up the battery using tweezers or other metal tools, as this will cause a short circuit.
- Wipe the battery with a clean dry cloth to ensure proper contact.
- **For California, USA only:** Included lithium battery contains Perchlorate Material – special handling may apply. For details see [www.dtsc.ca.gov/hazardouswaste/perchlorate](http://www.dtsc.ca.gov/hazardouswaste/perchlorate).





## Maintenance/Others

---

---

### Storage

If you do not intend to use the camcorder for a long time, store it in a place free of dust, in low humidity, and at temperatures not higher than 30 °C (86 °F).

---

---

### Cleaning

#### Camcorder Body

- Use a soft, dry cloth to clean the camcorder body. Never use chemically treated cloth or volatile solvents such as paint thinner.

#### Lens and Viewfinder

- If the lens surface is dirty, the autofocus may not work properly.
- Remove any dust or dirt particles using a non-aerosol type blower brush.
- Use a clean, soft lens-cleaning cloth to gently wipe the lens or viewfinder. Never use tissue paper.

#### LCD Screen

- Clean the LCD screen using a clean, soft lens-cleaning cloth.
- Condensation may form on the surface of the screen when the

temperature changes suddenly. Wipe it with a soft dry cloth.

---

---

### Condensation

Moving the camcorder rapidly between hot and cold temperatures may cause condensation (water droplets) to form on its internal surfaces. Stop using the camcorder if condensation is detected. Continued use may damage the camcorder.



#### Condensation may form in the following cases:

- When the camcorder is moved from an air-conditioned room to a warm, humid place
- When the camcorder is moved from a cold place to a warm room
- When the camcorder is left in a humid room
- When a cold room is heated rapidly

#### TO AVOID CONDENSATION

- Do not expose the camcorder to sudden or extreme changes in temperature.
- Remove the cassette, place the camcorder in an airtight plastic bag and let it adjust to temperature changes slowly before removing it from the bag.

### WHEN CONDENSATION IS DETECTED

- The camcorder automatically shuts off, the warning message “CONDENSATION HAS BEEN DETECTED” appears for approx. 4 seconds and  starts flashing.
- If a cassette is loaded, the warning message “REMOVE THE CASSETTE” appears and  starts flashing. Remove the cassette immediately and leave the cassette compartment open. Leaving the cassette in the camcorder may damage the tape.
- A cassette cannot be loaded when condensation is detected.

### RESUMING USE

The precise time required for water droplets to evaporate will vary depending on the location and weather conditions. After the condensation warning stops flashing, wait for 1 more hour before resuming use.

---

---

### Using the Camcorder Abroad

#### Power Sources

You can use the compact power adapter to operate the camcorder and to charge battery packs in any country with power supply between 100 and 240 V AC, 50/60 Hz. Consult the Canon Service Center for information on plug adapters for overseas use.

#### Playback on a TV Screen

You can only play back your recordings on TVs compatible with the NTSC system. The NTSC system is used in the following countries/areas:

American Samoa, Antigua, Aruba, Bahamas, Barbados, Bermuda, Bolivia, Canada, Chile, Colombia, Costa Rica, Cuba, Ecuador, El Salvador, Greenland, Guam, Guatemala, Haiti, Honduras, Jamaica, Japan, Korea, Mexico, Micronesia, Myanmar, Nicaragua, Panama, Peru, Philippines, Puerto Rico, Saint Kitts and Nevis, Saint Lucia, Saint Vincent and the Grenadines, Surinam, Taiwan, Trinidad and Tobago, USA, Venezuela, Virgin Islands.

### Trademark Acknowledgements

-  is a trademark.
- The SD logo is a trademark. The SDHC logo is a trademark.
- Microsoft, Windows and Windows Vista are trademarks or registered trademarks of Microsoft Corporation in the United States and/or other countries.
- Macintosh and Mac OS are trademarks of Apple Inc., registered in the United States and other countries.
- Other names and products not mentioned above may be trademarks or registered trademarks of their respective companies.



## System Diagram (Availability differs from area to area)

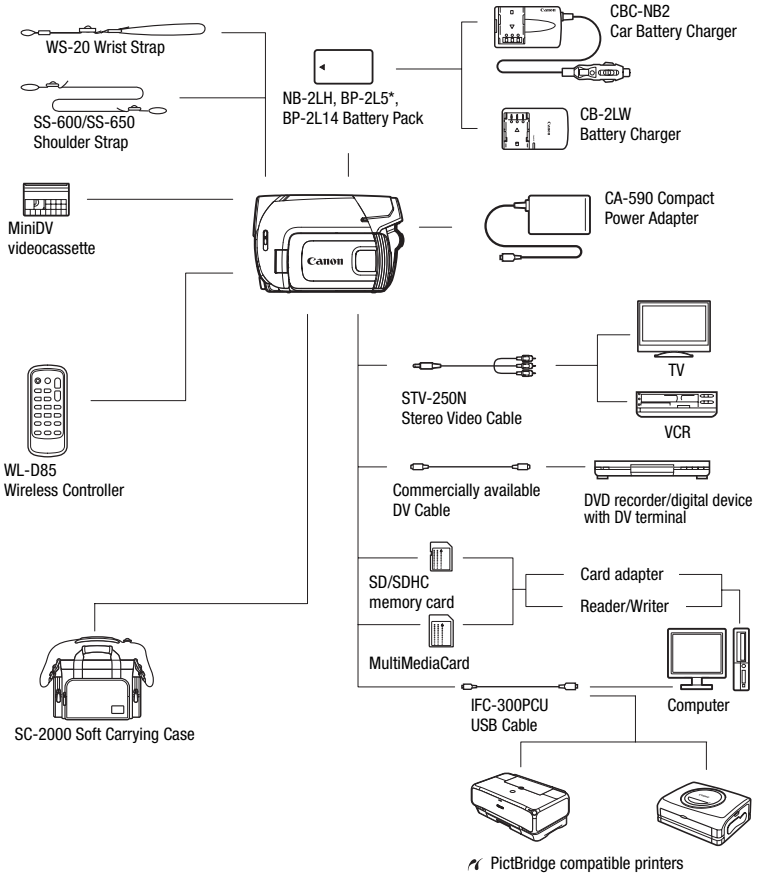

\* The BP-2L5 is not available as a separate optional accessory.

## Optional Accessories

Call or visit your local retailer/dealer for genuine Canon video accessories. You can also obtain genuine accessories for your Canon camcorder by calling: 1-800-828-4040, Canon U.S.A. Information Center.

### Use of genuine Canon accessories is recommended.

This product is designed to achieve excellent performance when used with genuine Canon accessories. Canon shall not be liable for any damage to this product and/or accidents such as fire, etc., caused by the malfunction of non-genuine Canon accessories (e.g., a leakage and/or explosion of a battery pack). Please note that this warranty does not apply to repairs arising out of the malfunction of non-genuine Canon accessories, although you may request such repairs on a chargeable basis.

### Battery Packs

When you need extra battery packs, select either the NB-2LH or the BP-2L14.

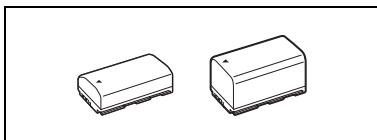

### CB-2LW Battery Charger

Use the battery charger to charge battery packs. It plugs directly into a power outlet without a cable.

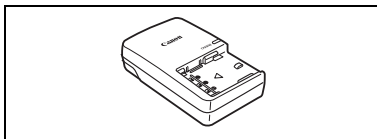

### Charging Times

The charging times given in the following table are approximate and vary according to charging conditions and initial charge of the battery pack.

Battery Pack →	BP-2L5	NB-2LH	BP-2L14
Charging Conditions ↓			
Using the camcorder	145 min.	155 min.	285 min.
Using the CB-2LW Battery Charger	105 min.	160 min.	205 min.



## Recording and Playback Times

The recording and playback times given in the following table are approximate and vary according to recording mode and charging, recording or playback conditions. The effective usage time of the battery pack may decrease when recording in cold surroundings, when using the brighter screen settings, etc.

Battery Pack	BP-2L5		NB-2LH		BP-2L14	
Screen Used	Viewfinder	LCD	Viewfinder	LCD	Viewfinder	LCD
Maximum Recording Time	90 min.	85 min.	125 min.	120 min.	270 min.	260 min.
Typical Recording Time*	45 min.	45 min.	65 min.	60 min.	145 min.	140 min.
Playback Time	-	110 min.	-	145 min.	-	315 min.

\* Approximate times for recording with repeated operations such as start/stop, zooming, and power on/off.

## CBC-NB2 Car Battery Charger

Use the car battery charger to charge battery packs on the move. The car battery cable plugs into your car's cigarette lighter and runs off a 12-24 V DC negative ground battery.

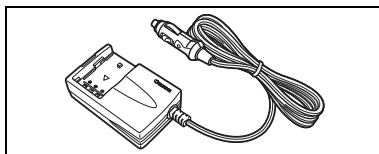

## Shoulder Strap

You can attach a shoulder strap for more security and portability. Pass the ends through the strap mount and adjust the length of the strap.

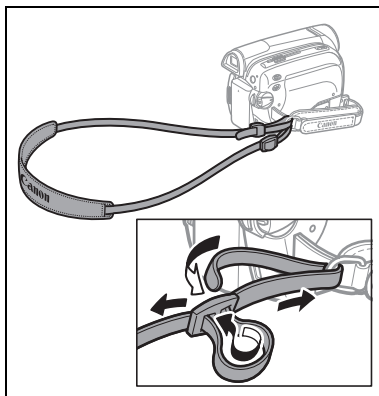

**WS-20 Wrist Strap**

Use this for extra additional protection for active shooting.

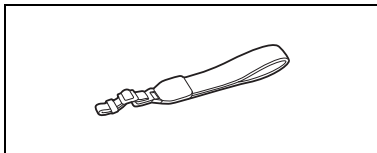

**SC-2000 Soft Carrying Case**

A handy camcorder bag with padded compartments and plenty of space for accessories.



This mark identifies genuine Canon video accessories. When you use Canon video equipment, we recommend Canon-brand accessories or products bearing the same mark.





---

---

## Product Codes

### Provided Accessories

CA-590 Compact Power Adapter	D85-1671-000
BP-2L5 Battery Pack	D85-1632-000
WL-D85 Wireless Controller	D83-0712-000
STV-250N Stereo Video Cable	3067A002BA (D82-0590-001)
IFC-300PCU USB Cable	6906A001AA (D82-0590-001)

### Optional Accessories

NB-2LH Battery Pack	9612A001AA
BP-2L14 Battery Pack	9582A002AA
CB-2LW Battery Charger	0763B001AA
CBC-NB2 Car Battery Charger	7873A002AA
WS-20 Wrist Strap	3118A002AA (D81-0190-202)
SC-2000 Soft Carrying Case	9389A001AA
DVM-CL DV Cleaning Cassette	3134A002AA (D36-0032-201)

## Specifications

### ZR950

#### System

<b>Video Recording System</b>	2 rotary heads, helical scanning DV system (consumer digital VCR SD system), digital component recording	
<b>Audio Recording System</b>	PCM digital sound: 16 bit (48 kHz/2 channels); 12 bit (32 kHz)	
<b>Television System</b>	EIA standard (525 lines, 60 fields) NTSC color signal	
<b>Image Sensor</b>	1/6-inch CCD, approx. 1,070,000 pixels Effective pixels <sup>1</sup> (all figures are approximate values)	
	16:9 Movies (advanced zoom) (other zoom types)	410,000 (T) / 710,000 (W) pixels 550,000 pixels
	4:3 Movies (advanced zoom) (other zoom types)	310,000 (T) / 690,000 (W) pixels 690,000 pixels
	Still images	800,000 pixels
<b>Compatible Tapes</b>	Videocassettes bearing the <sup>mini</sup> DV mark	
<b>Tape Speed</b>	SP: 18.81 mm/s (0.74 ips); LP: 12.56 mm/s (0.49 ips)	
<b>Maximum Recording Time (60 min. tape)</b>	SP: 60 minutes; LP: 90 minutes	
<b>LCD Screen</b>	2.7 in., wide, TFT color, approx. 112,000 pixels	
<b>Viewfinder</b>	0.35 in., wide, TFT color, approx. 114,000 pixels	
<b>Microphone</b>	Stereo electret condenser microphone	
<b>Lens</b>	f=2.6–96.2 mm, F/2.0–5.2, 37x power zoom 35 mm equivalent (all figures are approximate values)	
	16:9 Movies (advanced zoom) (other zoom types)	41.7–2,002 mm 47.1–1,743 mm
	4:3 Movies (advanced zoom) (other zoom types)	44.6–2,453 mm 44.6–1,650 mm
	Still images	41.5–1,536 mm
<b>Lens Configuration</b>	10 elements in 8 groups (1 double-sided, aspheric element)	
<b>AF system</b>	TTL autofocus, manual focus available	
<b>Minimum Focusing Distance</b>	1 m (3.3 ft); 1 cm (0.39 in.) on maximum wide angle	
<b>White Balance</b>	Auto white balance, preset white balance (DAYLIGHT, TUNGSTEN) or custom white balance	

<sup>1</sup> When two values are given, the first indicates the value at full telephoto (T) and the second indicates the value at full wide-angle (W).





<b>Minimum Illumination</b>	2.1 lx ([NIGHT] recording program, Shutter speed at 1/8) 8 lx ( <b>EASY</b> mode, Auto slow shutter [ON], Shutter speed at 1/30)
<b>Recommended Illumination</b>	More than 100 lx
<b>Image Stabilization</b>	Electronic

## Memory Card

<b>Recording Media</b>	SDHC (SD High Capacity) memory card, SD memory card, MultiMedia Card (MMC)*
<b>Size of Still Images</b>	1,152 x 864, 640 x 480 pixels
<b>File Format</b>	Design rule for Camera File system (DCF), Exif 2.2** compliant, DPOF compliant
<b>Image Compression Method</b>	JPEG (compression: Super Fine, Fine, Normal)

\* This camcorder has been tested with SD memory cards up to 2 GB. Performance cannot be guaranteed for all memory cards.

\*\* This camcorder supports Exif 2.2 (also called "Exif Print"). Exif Print is a standard for enhancing the communication between camcorders and printers. By connecting to an Exif Print-compliant printer, the camcorder's image data at the time of shooting is used and optimized, yielding extremely high quality prints.

## Input/Output Terminals

<b>AV Terminal</b>	∅ 3.5 mm minijack, output only Video: 1 Vp-p/75 ohms unbalanced Audio: -10 dBV (47 kohms load/3 kohms or less)
<b>DV Terminal</b>	4 pin (IEEE1394 standard), input/output
<b>USB Terminal</b>	mini-B

## Power/Others

<b>Power supply (rated)</b>	7.4 V DC (battery pack), 8.4 V DC (compact power adapter)
<b>Power consumption</b>	2.4 W (viewfinder), 2.5 W (LCD screen, normal brightness)
<b>Operating temperature</b>	0 – 40 °C (32 – 104 °F)
<b>Dimensions (W x H x D)</b>	68 x 82 x 127 mm (2.7 x 3.2 x 5.0 in.) excluding the grip belt
<b>Weight (camcorder body only)</b>	390 g (13.8 oz.)

---

---

**CA-590 Compact Power Adapter**

<b>Power input</b>	100 – 240 V AC, 50/60 Hz, 0.14 – 0.08 A
<b>Rated output</b>	8.4 V DC, 0.6 A
<b>Operating temperature</b>	0 – 40 °C (32 – 104 °F)
<b>Dimensions</b>	46 x 26 x 70 mm (1.8 x 1.0 x 2.8 in.)
<b>Weight</b>	95 g (3.4 oz.)

---

---

**BP-2L5 Battery Pack**

<b>Battery type</b>	Rechargeable Lithium Ion Battery
<b>Rated voltage</b>	7.4 V DC
<b>Operating temperature</b>	0 – 40 °C (32 – 104 °F)
<b>Battery capacity</b>	530 mAh
<b>Dimensions</b>	33.3 x 16.2 x 45.2 mm (1.3 x 0.64 x 1.8 in.)
<b>Weight</b>	40 g (1.4 oz.)

Weight and dimensions are approximate. Errors and omissions excepted. Subject to change without notice.



## Index

- 6-second auto date .....77
- A**
- Abroad, using the camcorder .....90
  - Aspect ratio
    - of a connected TV (TV type) .....75
    - of movies (Widescreen) .....74
  - Audio dubbing .....66
  - Audio mode .....44
  - Audio output channel .....44
  - Auto slow shutter .....74
  - Autofocus (AF): AF frame (9-point AiAF/Center point) .....55
  - AV terminal .....61
- B**
- Backup battery .....21
  - Battery pack
    - Charging .....19
    - Remaining charge indicator .....18
  - Beach (recording program) .....41
  - Beep .....77
- C**
- Compact power adapter .....19
  - Condensation .....89
  - Connections
    - to a computer .....67
    - to a TV/VCR .....61
- D**
- Data code .....39
  - Date and time
    - Date format .....78
    - Daylight saving time .....26
    - Time zone .....26
  - Date search .....38
  - Digital effects .....48
  - Digital video input (DV dubbing) .....64
  - Direct print .....57
  - Direct transfer .....69
  - DV terminal .....62, 67
- E**
- EASY (recording program) .....32
  - End search .....38
  - Erasing still images .....54
  - Error messages .....82
  - Exposure .....46
- F**
- File numbers .....78
  - Fireworks (recording program) .....41
  - Focus priority .....55
  - FUNC. menu .....24, 72
- G**
- Grip belt .....22
- I**
- Image effects .....48
  - Image jump .....53
  - Image stabilizer .....74
  - Index screen .....53
  - Initializing memory cards .....56
- J**
- Joystick .....23
  - Joystick guide .....23
- L**
- Language .....26
  - LCD screen .....27
  - LCD video light .....43
  - LP mode .....75

**M**

Magnifying a still image ..... 53  
 Maintenance ..... 89  
 Manual exposure adjustment ..... 46  
 Manual focus ..... 45  
 Markers ..... 77  
 Memory card ..... 30, 88  
 Mode switch ..... 32

**N**

Night (recording program) ..... 41

**O**

Onscreen display selection ..... 39

**P**

P (recording program) ..... 42  
 Playback  
     Movies ..... 36  
     Still images ..... 52  
 Portrait (recording program) ..... 41  
 Power save ..... 78  
 Print order ..... 59  
 Printing still images ..... 57  
 Protecting still images ..... 55

**Q**

Quick Start function ..... 34

**R**

Recording  
     Movies ..... 31  
     Still images ..... 50  
 Recording mode ..... 75  
 Recording programs ..... 40  
 Recording reminder ..... 18  
 Remaining tape indicator ..... 18  
 Remote sensor ..... 22  
 Reviewing  
     Movies (Record review) ..... 35  
     Still images (Review) ..... 74

**S**

Screen icons ..... 16  
 SD/SDHC card ..... 30, 88  
 Self timer ..... 43  
 Serial number ..... 13  
 Setup menus ..... 24, 73  
 Shutter speed ..... 42  
 Slideshow ..... 53  
 Snow (recording program) ..... 41  
 SP mode ..... 75  
 Special scene (recording programs) .. 40  
 Sports (recording program) ..... 41  
 Spotlight (recording program) ..... 41  
 Still image quality ..... 51  
 Still image size ..... 51  
 Sunset (recording program) ..... 41

**T**

Telephoto ..... 33  
 Transfer order ..... 71  
 Transferring to a computer  
     Movies ..... 68  
     Still images ..... 69  
 Tripod ..... 22  
 Troubleshooting ..... 79

**U**

USB terminal ..... 67

**V**

Video heads, cleaning ..... 2  
 Videocassettes ..... 29, 87  
 Viewfinder ..... 32  
 Volume ..... 36

**W**

White balance ..... 47  
 Wide angle ..... 33  
 Widescreen 16:9 ..... 74  
 Wind screen ..... 75  
 Wireless controller ..... 22



**Z**

Zero set memory .....37

Zoom

- Advanced zoom .....33
- Zoom speed .....33
- Zoom type .....33



**U.S.A.**

## **CANON CONSUMER DIGITAL VIDEO EQUIPMENT LIMITED WARRANTY FOR THE UNITED STATES**

The limited warranty set forth below is given by Canon U.S.A., Inc. ("Canon USA") with respect to Canon Consumer Digital Video Equipment (the "Equipment") purchased in the United States. This limited warranty is only effective upon presentation of your Bill of Sale or other proof of purchase.

The Equipment is warranted under normal, non-commercial, personal use, against defective materials or workmanship as follows:

**Parts:** Defective parts will be exchanged for new parts or comparable rebuilt parts for a period of ONE YEAR from the date of original purchase, except for a defective Video Head, which will be exchanged for a period of three months from the date of purchase.

**Labor:** For a period of ONE YEAR from the date of original purchase, labor will be provided free of charge by our factory service centers or designated service facilities located in the United States.

When returning Equipment under this warranty, you must pre-pay the shipping charges, and you must enclose the Bill of Sale or other proof of purchase with a complete explanation of the problem. During the ONE-YEAR warranty period, repairs will be made and the Equipment will be return-shipped to you free of charge. For repairs after the warranty period is over, you will be given an estimate of the cost of repair and an opportunity to approve or disapprove of the repair expense before it is incurred. If you approve, repairs will be made and the Equipment will be return-shipped to you. (shipping charges apply). If you disapprove, we will return-ship the equipment at no charge to you.

**Non-Canon brand peripheral equipment and software which may be distributed with, or factory loaded on, the Equipment, are sold "AS IS" without warranty of any kind by Canon USA, including any implied warranty regarding merchantability or fitness for a particular purpose. The sole warranty with respect to such non-Canon brand items is given by the manufacturer or producer thereof. If the Equipment contains a hard disk drive, Canon USA recommends that data stored on that drive be duplicated or backed up to prevent its loss in the event of failure or other malfunction of such drive.**

Canon USA shall have no responsibility under this limited warranty for use of the Equipment in conjunction with incompatible peripheral equipment and incompatible software.

In order to obtain warranty service, contact the authorized Canon retail dealer from whom you purchased the Equipment or call the CANON INFORMATION CENTER AT 1-800-OK-CANON). You will be directed to the nearest service facility for your Equipment.

This Limited Warranty covers all defects encountered in normal use of the Equipment and does not apply in the following cases:

- A) Loss or damage to the Equipment due to abuse, mishandling, accident, improper maintenance, or failure to follow operating instructions;
- B) If the Equipment is defective as a result of leaking batteries, sand, dirt or water damage;
- C) If defects or damages are caused by the use of unauthorized parts or by service other than by Canon USA's factory service centers or authorized service facilities;
- D) If the Equipment is used for commercial or industrial use.

This Limited Warranty does not cover cabinet (exterior finish), video cassette tape, head cleanings, nor does it apply to Equipment purchased outside the United States. This warranty does not cover units sold to rental firms, military operations, hotels, schools, hospitals or for other commercial, industrial, or institutional applications. These uses are covered only by such specific warranty as Canon may issue with such sales.

This Limited Warranty does not apply to accessories or consumables for the Equipment, which are sold "AS IS", without warranty of any kind by Canon USA.

Please retain this warranty card and your Bill of Sale as a permanent record of your purchase. This card is most important in order to be sure you are contacted right away should there be a safety inspection, modification or product recall under applicable laws or regulations.

**NO IMPLIED WARRANTY, INCLUDING MERCHANTABILITY AND FITNESS FOR A PARTICULAR PURPOSE APPLIES TO THIS EQUIPMENT AFTER THE APPLICABLE PERIOD OF EXPRESS WARRANTY OR GUARANTEE, EXCEPT AS MENTIONED ABOVE, GIVEN BY ANY PERSON, FIRM OR CORPORATION WITH RESPECT TO THIS EQUIPMENT SHALL BIND THE UNDERSIGNED (SOME STATES DO NOT ALLOW LIMITATIONS ON HOW LONG AN IMPLIED WARRANTY LASTS, SO THE ABOVE LIMITATION OR EXCLUSION MAY NOT APPLY TO YOU). CANON USA SHALL NOT BE LIABLE FOR LOSS OF REVENUES OR PROFITS, EXPENSE FOR SUBSTITUTE EQUIPMENT OR SERVICE, STORAGE CHARGES, LOSS OR CORRUPTION OF DATA, INCLUDING WITHOUT LIMITATION, LOSS OR CORRUPTION OF DATA STORED ON THE EQUIPMENT'S HARD DRIVE, OR ANY OTHER SPECIAL, INCIDENTAL OR CONSEQUENTIAL DAMAGES CAUSED BY THE USE, MISUSE OR INABILITY TO USE THE EQUIPMENT, REGARDLESS OF THE LEGAL THEORY ON WHICH THE CLAIM IS BASED, AND EVEN IF CANON USA HAS BEEN ADVISED OF THE POSSIBILITY OF SUCH DAMAGES. NOR SHALL RECOVERY OF ANY KIND AGAINST CANON USA BE GREATER THAN THE PURCHASE PRICE OF THE EQUIPMENT SOLD BY CANON USA AND CAUSING THE ALLEGED DAMAGE. WITHOUT LIMITING THE FOREGOING, YOU ASSUME ALL RISK AND LIABILITY FOR LOSS, DAMAGE OR INJURY TO YOU AND YOUR PROPERTY AND TO OTHERS AND THEIR PROPERTY ARISING OUT OF USE, MISUSE OR INABILITY TO USE THE EQUIPMENT NOT CAUSED DIRECTLY BY THE NEGLIGENCE OF CANON USA. (SOME STATES DO NOT ALLOW THE EXCLUSION OR LIMITATION OF INCIDENTAL OR CONSEQUENTIAL DAMAGES, SO THE ABOVE LIMITATION MAY NOT APPLY TO YOU). THIS WARRANTY SHALL NOT EXTEND TO ANYONE OTHER THAN THE ORIGINAL PURCHASER OF THIS EQUIPMENT OR THE PERSON FOR WHOM IT WAS PURCHASED AS A GIFT.**

This warranty gives you specific legal rights, and you may also have other rights which vary from state to state.  
CANON U.S.A., INC.

## CANADA

### CANON CONSUMER DIGITAL VIDEO EQUIPMENT LIMITED WARRANTY

The limited warranty set forth below is given by Canon Canada Inc. ("Canon Canada") with respect to Canon Consumer Digital Video Equipment (the "Equipment") purchased in Canada. This limited warranty is only effective upon presentation of a bill of sale or other proof of purchase for this Equipment to a Canon Service Facility when repairs are required.

The Equipment is warranted under normal, non-commercial, personal use, against defective materials or workmanship as follows:

**Parts:** Defective parts will be exchanged for new parts or, at Canon Canada's option, comparable rebuilt parts for a period of one year from the date of original purchase, except Video Heads which will be exchanged for a period of 3 months from the date of purchase.

**Labour:** For a period of one year from the date of original purchase, labour will be provided free of charge by our Canon Service Facilities in Canada.

This limited warranty covers all defects except where:

(a) The loss or damage to the product results from:

- i) accident, natural disaster, mishandling, abuse, neglect, unauthorized product modification or failure to follow instructions contained in the instruction manual;
- ii) the use of accessories, attachments, products, supplies, parts or devices with the Equipment that do not conform to Canon specifications or that cause abnormally frequent service problems;
- iii) repairs or services performed by any party other than a Canon Service Facility;
- iv) defective batteries or any exposure to water, sand or dirt;
- v) shipping (claim must be presented to the shipper);

(b) Any serial number on the video Equipment is altered or removed.

(c) The Equipment is used for commercial, professional or industrial purposes.

This limited warranty does not cover the cabinet (exterior finish) of the Equipment, media, nor does it apply to Equipment purchased outside Canada. If the Equipment contains a hard disk drive, Canon Canada recommends that data stored on that drive be duplicated or backed up to prevent its loss in the event of a failure or other malfunction of such drive.

#### TO OBTAIN WARRANTY SERVICE

Ship your Equipment in its original carton, box or equivalent, properly packed, fully insured with shipping charges prepaid, together with a copy of your bill of sale or other proof of purchase and a description of the problem to any of the Canon Service Facilities in Canada.

#### LIMITATIONS

Except as otherwise required by applicable legislation, this warranty is in lieu of all other warranties, conditions, guarantees or representations, express or implied, statutory or otherwise, relative to the Equipment, including implied warranties or conditions of merchantability or fitness for a particular purpose.

Canon Canada assumes no liability for special, consequential or incidental damages, loss or corruption of data including, without limitation, data stored on the hard disk drive of the Equipment or loss that may arise, whether on account of negligence or otherwise, from the use, misuse or inability to use the Equipment (including loss of profit, revenue, media or enjoyment) or from failure to conform to any express or implied warranties, conditions, guarantees or representations. Any recovery under this limited warranty shall not exceed the purchase price of the equipment. Canon Canada does not assume or authorize any other person to assume for Canon Canada any other liability with respect to this equipment. This warranty does not extend to any person other than the original purchaser of the Equipment or the person for whom it was purchased as a gift and states your exclusive remedy.

#### NOTICE TO CONSUMER

If you plan to take important videos or if the product has not been used for some time, please check all functions with the instruction book before using it.



DIM-841

---

**U.S.A.****CANON U.S.A., INC. NEW JERSEY OFFICE**

100 Jamesburg Road, Jamesburg, NJ 08831 USA

**CANON U.S.A., INC. CHICAGO OFFICE**

100 Park Blvd., Itasca, IL 60143 USA

**CANON U.S.A., INC. LOS ANGELES OFFICE**

15955 Alton Parkway, Irvine, CA 92618 USA

**CANON U.S.A., INC. HONOLULU OFFICE**

210 Ward Avenue, Suite 200, Honolulu, HI 96814 USA

- ❖ If you have any questions, call the Canon U.S.A. Information Center toll-free at 1-800-828-4040 (U.S.A. only).

---

**CANADA****CANON CANADA INC. NATIONAL HEADQUARTERS**

6390 Dixie Road, Mississauga, Ontario L5T 1P7

**CANON CANADA INC. CALGARY**

2828, 16th Street, N.E. Calgary, Alberta T2E 7K7

**CANON CANADA INC. MONTREAL**

5990 Côte de Liesse, Quebec H4T 1V7

- ❖ If you have any questions, call the Canon Canada Information Center toll-free at 1-800-828-4040 (CANADA only).
- ❖ Si vous avez des questions, veuillez téléphoner sans frais au Canada 1-800-828-4040 (CANADA seulement).

---

**MEXICO****CANON MEXICANA, S. DE R.L. DE C.V.**

Periférico Sur No. 4124, Col. Ex-Rancho de Anzaldo,

C.P. 01900 México, D.F., México

**CANON U.S.A., INC. NEW JERSEY OFFICE**

100 Jamesburg Road, Jamesburg, NJ 08831 USA

---

**CENTRO Y  
SURAMÉRICA****CANON LATIN AMERICA, INC.**

703 Waterford Way, Suite 400, Miami, FL 33126 USA

---

**ASIA****CANON HONGKONG COMPANY LTD.**

19/F, The Metropolis Tower, 10 Metropolis Drive,

Hunghom, Kowloon, Hong Kong

---

The information in this manual is verified as of 1 January 2008.

Les informations contenues dans ce manuel ont été vérifiées le 1er janvier 2008.

La información de este manual fué verificada el 1 de enero de 2008.



Printed on 70% reused paper.

Document réalisé avec du papier recyclé à 70%.

Impreso en papel reciclado al 70%.



## Free Manuals Download Website

<http://myh66.com>

<http://usermanuals.us>

<http://www.somanuals.com>

<http://www.4manuals.cc>

<http://www.manual-lib.com>

<http://www.404manual.com>

<http://www.luxmanual.com>

<http://aubethermostatmanual.com>

Golf course search by state

<http://golfingnear.com>

Email search by domain

<http://emailbydomain.com>

Auto manuals search

<http://auto.somanuals.com>

TV manuals search

<http://tv.somanuals.com>