

Single-Package Heat Pump Units

The 50MQ units are completely self-contained cooling and heating systems with provision for addition of accessory electric heaters. They are air-to-air heat pumps designed for outdoor installation. They may be connected into existing duct systems which are properly sized and designed to handle an air quantity of 400 to 500 cfm per ton of cooling. Required connections include air ducts, condensate drain, line and control power wiring. Field-supplied filter must be installed in return air duct. (See Table 1 for filter size.)

INSTALLER'S PRELIMINARY SURVEY

Step 1 — Inspect Equipment — File claim with shipping company if shipment is damaged or incomplete.

Step 2 — Complete or Consider the Following before installing the 50MQ unit:

- Consult local building codes for special installation requirements.
- Provide sufficient space for coil air flow clearance, wiring, and servicing unit. (See Fig. 1.)
- Locate unit where supply and return air ducts can be conveniently brought out to unit duct connections.
- Unit may be placed with duct side as close to building as condensate drain, top removal, duct connections and power connections will permit. Position unit so water or ice from roof will not drop directly on top of unit or in front of coil.
- Make provisions for condensate drainage and defrost water disposal. See Mounting Pad and Cooling Cycle Condensate Disposal.
- Roof installation method for 50MQ will depend on building construction and special requirements of local building codes. Ensure roof will support unit weight. See Mounting Pad for details.

Table 1 — Installation Data (See Fig. 1.)

UNIT	50MQ022	50MQ027	50MQ032	50MQ037	
OPER WT (lb)	315	330	340	353	
DIMENSIONS (ft.-in.)	A	3- 6 $\frac{1}{4}$			
	B	3- 2			
	C*	2- 3 $\frac{5}{8}$	2- 3 $\frac{5}{8}$	2- 3 $\frac{5}{8}$	2- 7 $\frac{5}{8}$
	D	1-10 $\frac{3}{4}$	1-10 $\frac{3}{4}$	1-10 $\frac{3}{4}$	1-10 $\frac{3}{4}$
	E	0- 6 $\frac{3}{16}$	0- 6 $\frac{3}{16}$	0- 6 $\frac{3}{16}$	0- 6 $\frac{3}{16}$
	F	0-10 $\frac{13}{16}$	0-10 $\frac{13}{16}$	0-10 $\frac{13}{16}$	0-10 $\frac{13}{16}$
	G	1- 1 $\frac{3}{16}$	1- 1 $\frac{3}{16}$	1- 1 $\frac{3}{16}$	1- 1 $\frac{3}{16}$
DUCT CONN. (ft.-in.)	Side-by-Side Rectangular				
	H	1- 9 $\frac{5}{8}$			
	J	0-10 $\frac{3}{8}$			
	K	1- 9 $\frac{5}{8}$			
FILTER SIZE† (in.)	L				
	1- 7 $\frac{5}{8}$				
Disposable	20 x 25	20 x 25	15 x 20(2)	15 x 20	
	15 x 20	20 x 20	20 x 20	20 x 25	

*Dimension "C" includes 1 1/4-in. built-in base support channels (2)
†Recommended field-supplied filters are 1-in. thick

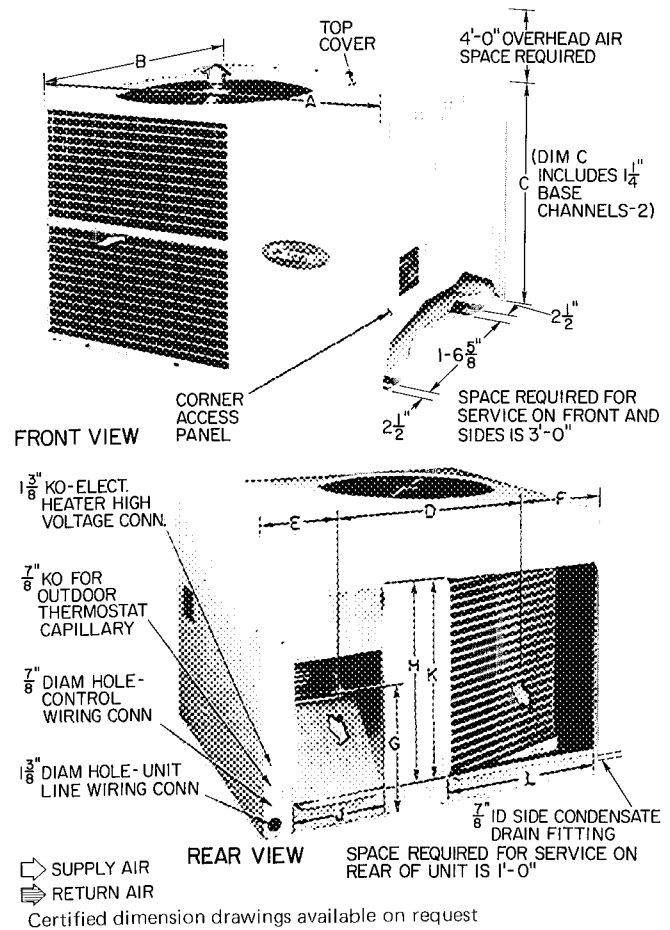

Fig. 1 — Dimensions and Connections

MOUNTING PAD

Step 3 – On the Ground: Mount Unit on a Solid, Level Concrete Pad. See Fig. 2 for pad dimensions. Ensure pad does not obstruct coil slots in unit base pan. (Slots drain water during heating cycle). Construct pad a minimum of 6 in. thick to provide clearance under base pan coil slots for drainage and ice buildup. In areas where prolonged subfreezing temperatures, drifting or heavy snows occur, increase clearance to 12 to 18 inches. If climatic conditions dictate, construct an angle iron frame to support unit 12 to 18 in. off concrete base. Cross angle of frame must not obstruct base pan coil slots. Extend a 24-in. gravel apron around pad for condensate and defrost water drainage field.

Step 4 – On the Roof: Mount Unit on a Level Platform or Frame. Unit must be elevated for proper clearance as described under ground installation above. Roof design and water drainage must be planned to prevent unit and its duct flashing from sitting in water.

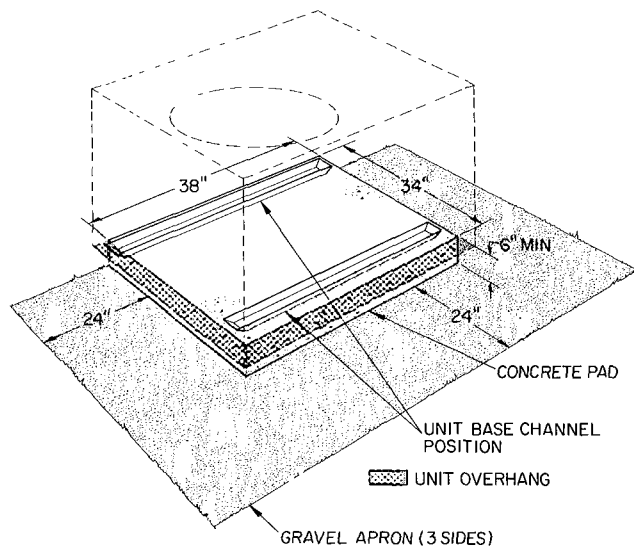

Fig. 2 – Concrete Pad Dimensions

DUCTWORK

Step 5 – Connect Supply and Return Air Ductwork to unit supply and return air duct connections. Refer to Fig. 1 and Table 1 for unit supply and return air connection sizes and locations.

Flanges are provided on unit for rectangular duct connections. Fig. 3 shows a typical duct system with 50MQ installed. Do not operate unit longer than 5 minutes without ductwork. If necessary, refer to Carrier System Design Manual, Part 2,

for system air duct design. When designing and installing ductwork, consider the following.

- When connecting ductwork to unit, do not drill holes in area shown below. Coil may be damaged.

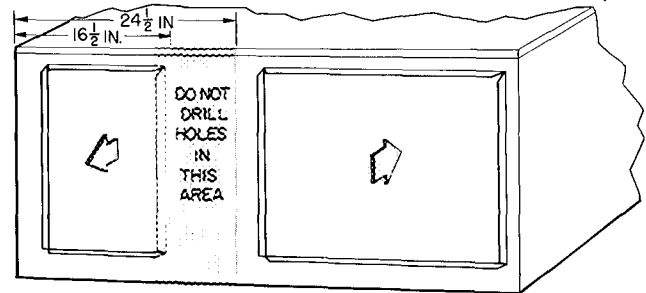

- All units should have field-supplied filters installed in return air ductwork. Recommended sizes for filters are shown in Table 1.
- Avoid abrupt duct size increases and reductions.
- Use flexible connectors between ductwork and unit to prevent transmission of vibration. When electric heater is installed, use fireproof asbestos (or similar heat resistant material) connector between ductwork and unit discharge connection. Heat resistant duct connector must extend 24 in. from electric heater element.
- Size ductwork for cooling air quantity (cfm). The minimum air quantity for safe electric heater operation is:

UNIT	INDOOR FAN SPEED	ELECTRIC HEATER KW				
		5.0	7.5	10.0	15.0	20.0
50MQ022	Med-Low	733	733	733	—	—
50MQ027	Med-Hi	900	900	900	—	—
50MQ032	Med-Low	1068	1068	1068	1068	—
50MQ037	Med-Low	1230	1230	1230	1230	1230

Heater limit switches may trip at air quantities below those recommended.

- All external ductwork must be insulated and weatherproofed. Ducts passing thru unconditioned space must be insulated and covered with vapor barrier in accordance with the latest issue of SMACNA's (Sheet Metal and Air Conditioning Contractors National Association) and NESCA's (National Environmental Systems Contractors Association) minimum installation standards for residential heating and air conditioning systems.
- Secure all ducts to building structure. Weatherproof duct openings in wall or roof according to good construction practices.

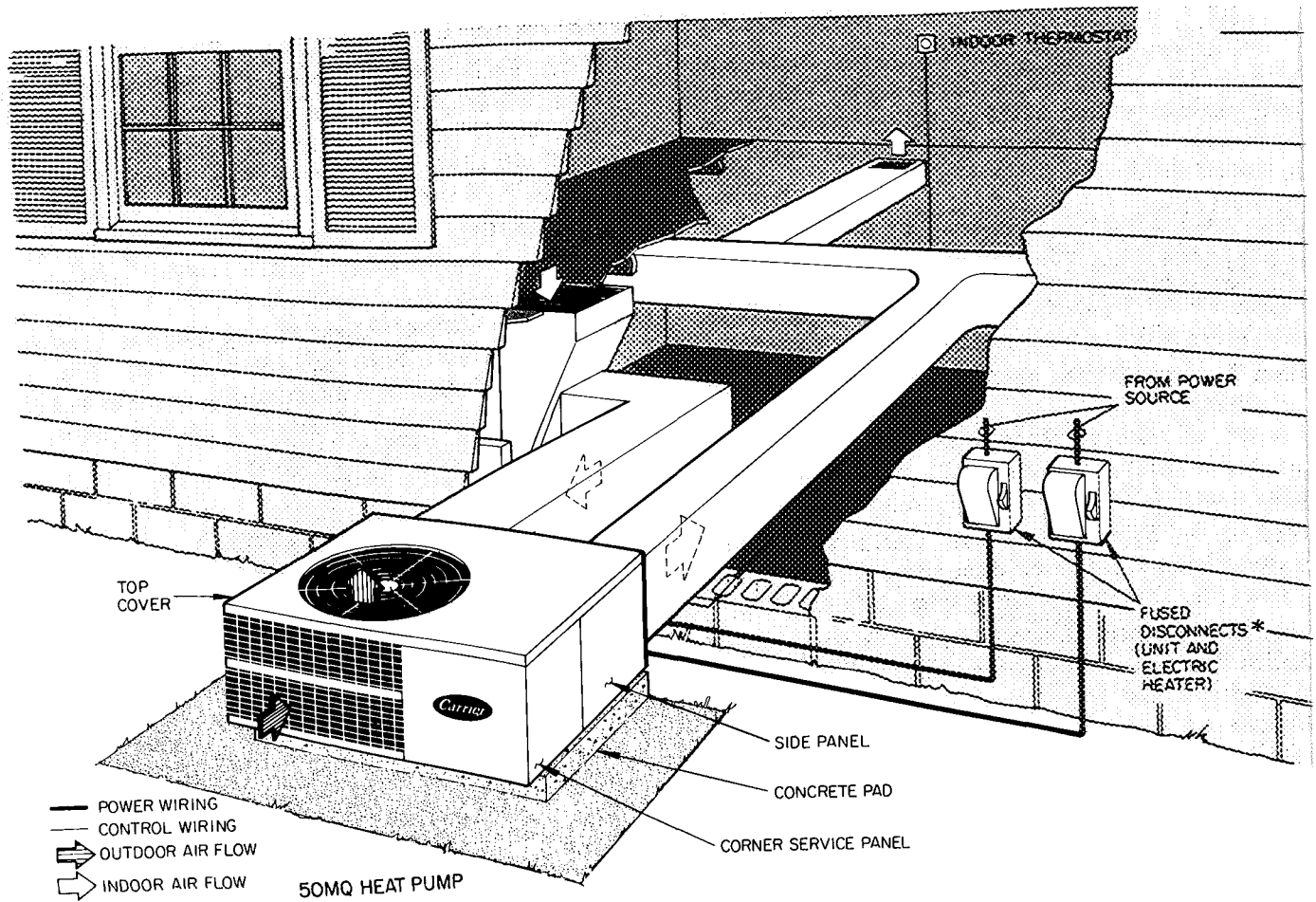

*Separate fused disconnect required for electric heater.

Fig. 3 — Typical Installation

COOLING CYCLE CONDENSATE DISPOSAL

Condensate may be drained directly onto gravel apron or connected by drain line(s) to a dry well. Condensate disposal methods must comply with local codes and practices.

Step 6 — Connect a Drain Line to rubber condensate drain fitting on side of unit (see Fig. 1). Use clamp provided. Install factory-supplied condensate trap (taped to indoor fan housing for shipment) at end of drain line. If a drain line is not used, connect condensate trap to unit drain fitting as shown in Fig. 4.

ELECTRIC HEATER INSTALLATION

For complete heater installation data, including accessory outdoor thermostat and emergency heat switch, refer to accessory electric heater Installation, Start-Up and Service booklet. Complete control wiring connections are shown in this booklet.

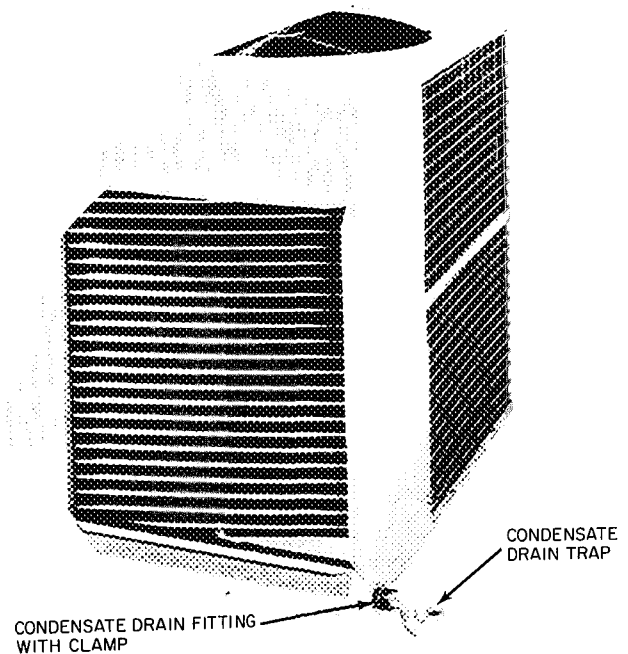

Fig. 4 — Condensate Drain Connection

ELECTRICAL DATA AND WIRING

Field wiring must comply with local and national fire, safety and electrical codes. Voltage to unit must be within $\pm 10\%$ of voltage indicated on nameplate. On 3-phase units, phases must be balanced within 2%.

Operation of unit on improper line voltage or with excessive phase unbalance constitutes abuse and is not covered by Carrier Warranty.

See Table 2 for recommended wire and fuse sizes

Step 7 – Install a Branch Circuit Fused Disconnect of adequate size to handle unit starting current. Locate disconnect within sight of and readily accessible from the unit. (Use a separate fused disconnect(s) for each electric circuit as required.)

Step 8 – Bring Line Power Leads Into Unit. Extend leads from fused disconnect thru hole provided (Fig. 1) into line wiring splice box (Fig. 5).

Step 9 – Connect Ground Lead to Ground Lug in Splice Box before connecting power wiring. See Fig. 6. Connect line power leads to yellow and black pigtails on single-phase units or yellow, blue and black pigtails on 3-phase units. Use wire nuts provided. Tape each connection. Wire nuts are suitable for copper or aluminum wire since they contain joint compound.

Step 10 – Set Indoor Fan Motor Speed – (Refer to page 2 for minimum allowable air quantity for safe electric heater operation). Four-speed indoor fan motor is factory wired for high speed operation. Fan motor is equipped with spade-type speed selector terminals marked 1, 2, 3 and 4. For lower fan speed, remove black *unit* lead from motor spade terminal 1 and connect to spade terminal 2, 3 or 4. On alternate fan motors remove black

motor lead from unit connection and replace with blue, orange or red motor lead.

MOTOR LEAD	Black	Blue	Orange	Red
MOTOR TERMINAL	1	2	3	4
FAN SPEED	High	Medium High	Medium Low	Low

Step 11 – Control Power Wiring (24 v) is brought through 7/8-in. hole provided in unit, Fig. 1. Extend leads to unit control wiring terminal board, Fig. 5. Connect leads to terminal board as directed in Fig. 7.

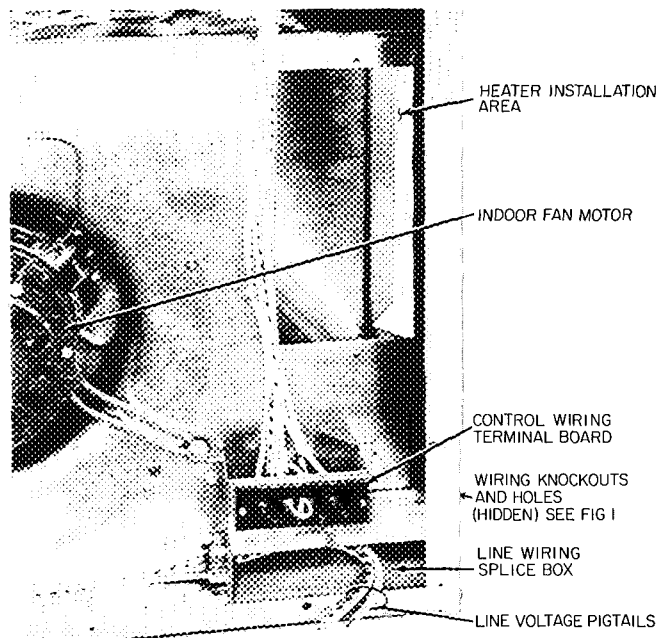

Fig. 5 – Unit Wiring Terminal Location

Table 2 – Unit Electrical Data

MODEL	V/PH	OPER VOLTAGE*		COMPRESSOR		IFM	OFM	BRANCH CIRCUIT			
		Max	Min	LRA	FLA	FLA	FLA	Power Wire Size (AWG)	Max Ft Wire	Gnd Wire Size† (AWG)	Max Fuse Amps
50MQ022	200/1	220	180	75	14.1	2.2	2.2	10	40	10	35
50MQ027				80	16.2	2.2	2.2	10	35	10	40
50MQ032				99	20.8	3.6	2.2	8	43	10	50
50MQ037				112	26.5	3.9	2.2	8	35	10	60
50MQ022	230/1	254	207	68	12.8	2.0	1.9	12	32	12	30
50MQ027				72	14.0	2.0	1.9	10	47	10	35
50MQ032				88	18.0	3.1	1.9	10	36	10	45
50MQ037				100	23.0	3.4	1.9	8	45	10	50
50MQ032	200/230/3	254	180	75	13.0/11.5	3.6/3.1	2.2/1.9	10/12	50/42	10/12	35/30
50MQ037	200/230/3	254	180	80	15.0/12.8	3.9/3.4	2.2/1.9	10/10	45/60	10/10	35/30

FLA – Full Load Amps
LRA – Locked Rotor Amps
IFM – Indoor Fan Motor
OFM – Outdoor Fan Motor

*Permissible limits of the voltage range at which the units will operate satisfactorily.

†Required when using nonmetallic conduit.

NOTES:

1. Fan motors are 200-v or 230-v, single-phase.
2. All units equipped with 24-v transformer for external control circuit.
3. Copper wire sizes based on 60 C. Aluminum field wiring may be used when splice connected to copper pigtails from unit with factory-supplied wire nuts. Use latest National Electrical Code for aluminum wire sizing.

The 50MQ unit transformer supplies 24-v power for complete system including accessory electric heater up to 10 kw. Electric heaters over 10 kw are equipped with 24-v transformer used to power heater controls.

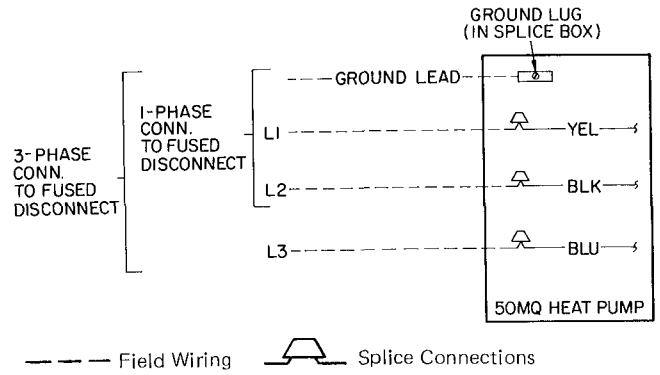

Fig. 6 — Line Power Connections

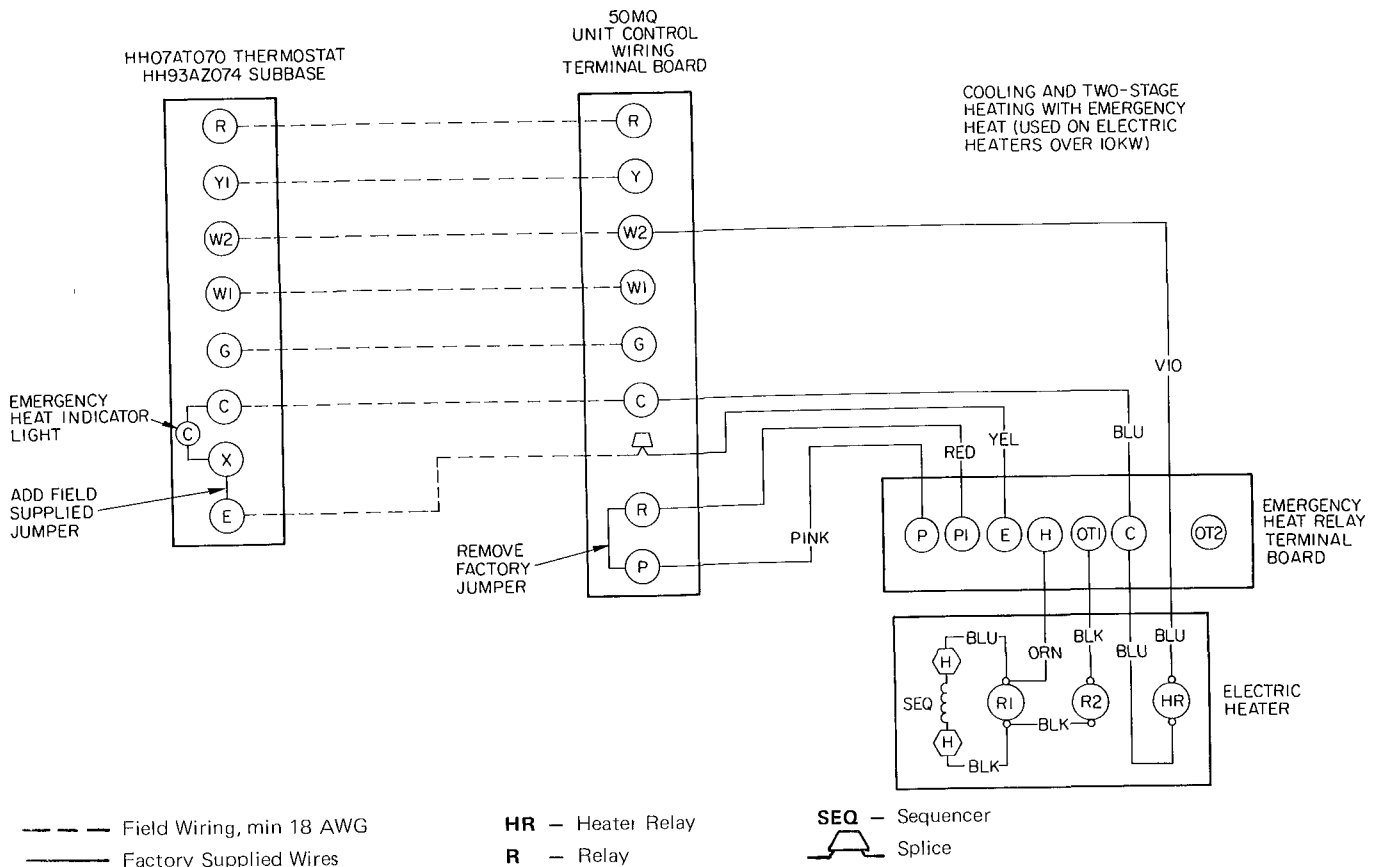
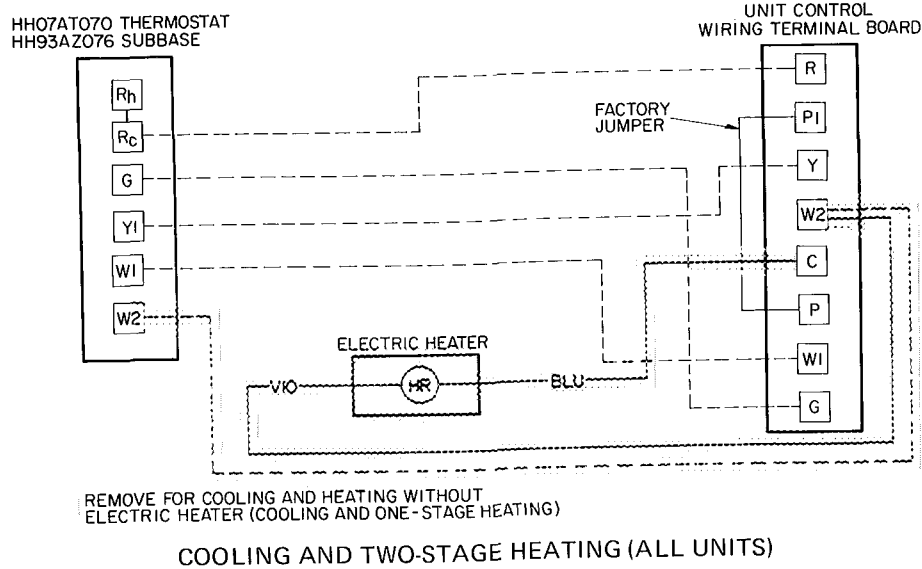

Fig. 7 — Control Circuit Connections

START-UP

The 50MQ units are equipped with a crankcase heater. It is recommended that heater be energized a minimum of 24 hours before starting unit. To energize heater only, turn the thermostat to "Off" position and close electrical disconnect to 50MQ unit.

Heat Anticipator Settings for Room Thermostat (HH07AT070) — Set anticipator settings for room thermostat according to Table 3. These settings may be changed slightly to provide a greater degree of comfort for a particular installation.

Accessory Outdoor Thermostat provides adjustable outdoor control of accessory electric heater over 10 kw. This thermostat makes contact when a drop in outdoor temperature occurs. It energizes a second stage of electric heat when the outdoor temperature setting is reached, provided the room thermostat is on the second stage of heating. Refer to heat load of building for correct outdoor thermostat setting. The accessory emergency heater relay is manually operated to lock out compressor and bypass the outdoor thermostat for electric heater operation during heat pump shutdown. See 88EH electric heater Installation, Start-Up and Service Instructions for installation of outdoor thermostat and emergency heater relay.

To Start Unit — (Ensure crankcase heater has been energized for 24 hours.) Adjust the thermostat as follows:

1. Set selector switch at "Off."
2. Set fan switch as desired ("Fan") ("Auto.").
3. Turn on main disconnect switch(es) to unit.
4. Set thermostat dial to the desired temperature.
5. Set selector switch at "Heat" or "Cool." Check system refrigerant charge. See Refrigerant Charging.

50MQ Unit Single-Phase Compressors of the split capacitor (PSC) type require an equalized system pressure to start. When supply voltage is within permissible limits and compressor does not start, give compressor a temporary capacitance boost. Use an 88-108 microfarad start capacitor with a bleed resistor wired across the terminals. Connect wires with insulated probes to each capacitor terminal. Touch probes to each side of run capacitor or to compressor motor terminals R and S. Start compressor; *pull probes away after 3 seconds Discharge start capacitor.* (Two or more bumps may be necessary to start compressor.) Run compressor for 20 to 30 minutes, then shut off and allow system pressure to equalize. Try restarting without boost capacitor. If after 2 attempts (without boost capacitor) the compressor does not start, add an accessory start capacitor relay package.

UNIT CONTROLS

High-Pressure Relief Valve (Safety Control) is located in compressor. Relief valve opens at a

Table 3 — Thermostat Anticipator Settings

UNIT	FIRST-STAGE ANTICIPATOR SETTING	ACCESSORY ELECTRIC HTR (Kw)		SECOND-STAGE ANTICIPATOR SETTINGS
		240 v	208 v	
50MQ022, 027,032, 037	.4	5.0	3.75	4
		7.5	5.6	56
		10.0	7.5	56
		15.0	11.3	.4
		20.0	15.0	.4

pressure differential of approximately 600 psi between suction (low side) and discharge (high side) to allow pressure equalization. The valve also permits pressure equalization when high-side — low-side pressure differential reaches 90 psig at shutdown. Compressor can then start unloaded. A hissing sound during pressure equalization indicates pressures are equalizing and does not indicate bad valves.

Internal Current and Temperature Sensitive Overload (Safety Control) resets automatically when internal compressor motor temperature drops to a safe level (overloads may require up to 45 minutes to reset). When an internal overload is suspected of being open, check by using an ohmmeter or continuity tester. If necessary, refer to Carrier Standard Service Techniques Manual, Chapter 2, for complete instructions.

Defrost Control, consisting of a defrost timer, defrost thermostat and defrost relay, interrupts normal system heating operation if enough frost forms on outdoor coil to impair unit performance. Defrost control simultaneously stops outdoor fan, de-energizes reversing valve solenoid to return system to cooling cycle (outdoor unit as condenser, indoor unit as evaporator), and activates accessory electric heater. Unit can defrost every 90 minutes, but will defrost only if required.

For the heat pump to defrost, 2 conditions are necessary:

1. Defrost timer contacts must be closed.
2. Refrigerant temperature from outdoor unit must be cold enough to cause defrost thermostat contacts to close. Contacts close at 35 (+0, -6) F.

Every 90 minutes of elapsed running time, the defrost timer contacts close for 10 seconds. If the defrost thermostat contacts are closed, the unit defrosts. The defrost timer limits defrosting period to 10 minutes. Normally the frost is removed and the defrost thermostat contacts will open to terminate defrosting before 10 minutes have elapsed. Defrost thermostat contacts open at 65 (+0, -6) F. When defrosting is terminated, the outdoor fan motor and reversing valve solenoid are energized returning unit to heating cycle.

HEAT PUMP CIRCUITS shown in Fig. 8 are refrigerant flow diagrams for heating and cooling cycles.

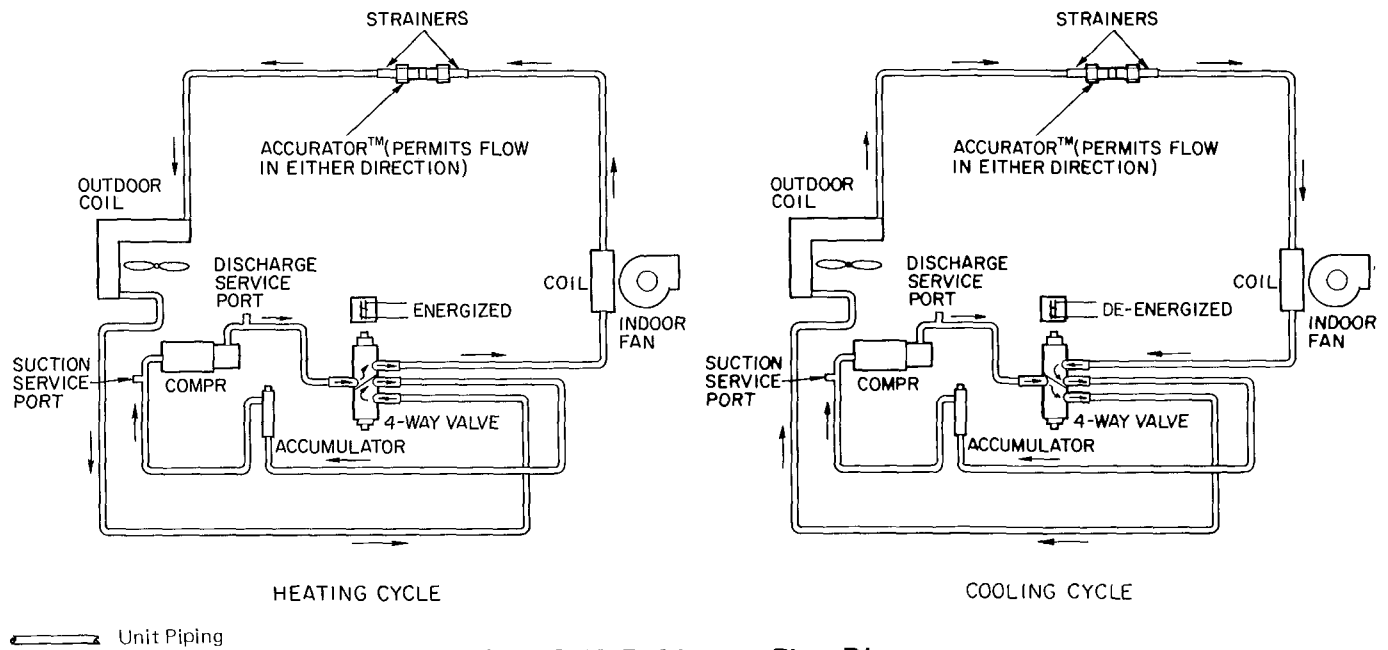

Fig. 8 – 50MQ Refrigerant Flow Diagrams

SERVICE

Table 4 – Service Data

UNIT	50MQ022	50MQ027	50MQ032	50MQ037
R-22 CHG (lb-oz)*	5.0	5.7	5.7	5.8
Refrig Control	AccuRater™			
INDOOR FAN	Centrifugal – Direct Drive			
Rpm	1050-950-850-800			
Diameter (in.)	9	9	10	10
Width (in.)	8	8	8	8
Range Cfm	733-915	900-1125	1068-1332	1230-1540
Motor Hp	1/4	1/4	1/3	1/3
OUTDOOR FAN	Propeller – Direct Drive			
Cfm	3000			
Rpm	1050			
Diameter (in.)	20			
Motor Hp	1/4			

*Factory refrigerant charge.

REFRIGERANT CHARGING

Unit refrigerant system is factory charged. When *recharging* is necessary during heating or cooling season, weigh in total charge indicated in Table 4. (Charge must be weighed in during heating season.) Blow any refrigerant remaining in system before recharging. Standard 1/4-in. Schrader Service Connections (Fig. 9) are provided on high and low sides of refrigerant system for evacuation and charging.

Dial-a-charge charging cylinder is an accurate device used to recharge systems by weight. These cylinders are available at refrigeration supply firms.

A Carrier Chargemaster® charging device (Carrier Part No. 38GC680004) may be used to check or adjust refrigerant charge *during cooling season*. The Chargemaster may also be used as an alternate method of recharging system.

Chargemaster Operation – Operate unit 10 minutes before using Chargemaster.

1. Tape Chargemaster feeler bulb to unit suction line. Insulate bulb. Ensure suction line is clean for good contact with bulb.
2. Connect refrigerant drum to Chargemaster inlet port with drum in position for vapor charging.
3. Connect Chargemaster outlet port (loosely) to unit suction line Schrader valve.
4. Crack valves on refrigerant drum and Chargemaster to purge lines from drum to suction line Schrader valve. After purging lines, close valve on Chargemaster only. Tighten Chargemaster® connection at suction line Schrader valve.
5. Measure outdoor air dry-bulb temperature at unit.
6. Read *evaporator temperature at red needle position* on Chargemaster temperature gage and *suction line temperature at black needle position*

CAUTION: Do not read evaporator temperature with Chargemaster valve open.

7. Enter 50MQ Chargemaster Charging Chart, Table 5, at outdoor air temperature (step 5) and evaporator temperature (step 6). Find the suction line temperature required for correct system charge. If actual suction line temperature (step 6) is higher than table value, the system is undercharged. If suction line temperature is lower than table value, the system is overcharged.

Example: At outdoor air temperature of 85 F and evaporator temperature of 40 F, the system will be correctly charged at 48 F (±2 F) suction line temperature.

8. Add charge by slowly opening Chargemaster[®] valve. If necessary, reduce charge by bleeding at liquid line Schrader valve. Check outdoor air and evaporator temperature during procedure. If they change, refer back to Chargemaster Charging Chart for new value.

Correct use of Chargemaster ensures an optimum refrigerant charge will be in system when conditions and system components are normal. However, the Chargemaster does not solve or fix system abnormalities. It indicates correct charge for condition of system. It will not make corrections for dirty filters, slow fans, excessively long or short suction lines, or other abnormal conditions. This charging device ensures that a correct relationship exists between outdoor temperature, evaporator temperature, and suction line temperature on a specific system.

Table 5 — 50MQ Chargemaster[®] Charging Chart

OUTDOOR TEMP (F)	EVAPORATOR TEMPERATURE (F)*												
	28	30	32	34	36	38	40	42	44	46	48	50	52
	Suction Line Temperatures												
60	42	50	65	72									
65		40	48	56	66								
70			36	46	56	66							
75				37	46	55	64						
80					40	47	55	62					
85						42	48	54	61				
90							44	49	55	60			
95							40	45	50	55	60		
100									44	50	54	59	
105											50	54	58

*Saturated temperature which is the equivalent temperature of pressure taken at the heat pump suction Schrader fitting.

COMPRESSOR REMOVAL

See Table 6 for compressor information and Fig. 10 for component location.

1. Shut off power to unit. Vent refrigerant to atmosphere or use refrigerant removal methods shown in Carrier Standard Service Techniques Manual, Chapter 1.
2. Remove unit corner access panel, Fig. 1.
3. Remove core from suction and discharge line Schrader valves.
4. Disconnect compressor wiring at compressor terminal box. Carefully unsweat suction and discharge (hot gas) lines at compressor. Do not stress or move compressor discharge line or it may break at condenser connection.

CAUTION: Excessive movement of copper lines at compressor may cause a break where lines connect to evaporator or condenser.

5. Remove crankcase heater from compressor base.

6. Remove compressor hold-down bolts. Lift compressor out.

CAUTION: Aluminum tubing is used in 50MQ unit coils. Do not overheat or place excessive strain on tubing or damage may result.

Table 6 — Compressor Data

MODEL	V/PH	PRODUCTION COMPRESSOR	OIL RECHARGE (oz)
50MQ022	200/1	MB2423CB	44
50MQ027		MB2723CB	
50MQ032		MB3423CB	
50MQ037	MB4023CB		
50MQ022	230/1	MD2423CB	
50MQ027		MD2723CB	
50MQ032		MC3423CB	
50MQ037		MC4023CB	
50MQ032	200-230/3	MF3423CB	
50MQ037		MF4023CB	

Filter-Drier — Install a filter-drier in compressor suction line when refrigerant system is opened for service as described under Compressor Removal. Fig. 9 shows suggested position of drier. Check filter-drier pressure drop at drier service port and unit suction line Schrader fitting. Ensure pressure drop does not exceed 2 psi.

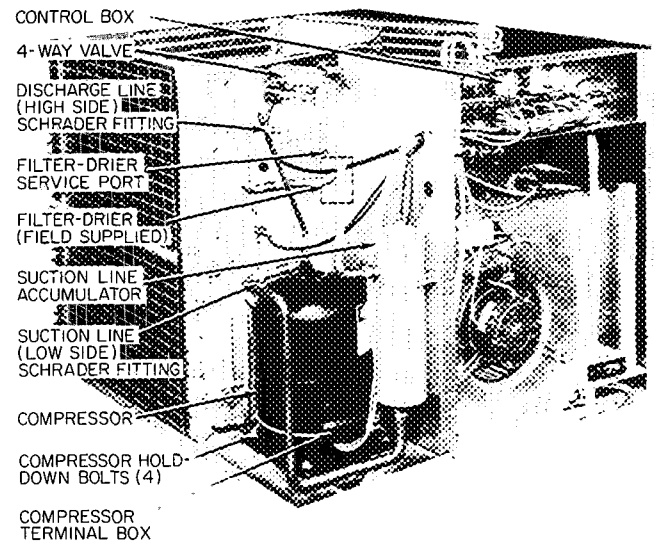

Fig. 9 — Compressor Removal

MAINTENANCE

Lubrication

COMPRESSOR contains factory oil charge. Replace oil when lost. See Table 6 for oil recharge. If necessary, refer to Carrier Standard Service Techniques Manual, Chapter 1, pg 1-21, for oil recharging procedure. Use Carrier PP33-1, Texaco Capella B or Suniso 3G oil.

FAN MOTOR BEARINGS are prelubricated for 3 years heavy duty or 5 years normal duty. When lubrication is necessary, send motor to authorized motor repair shop.

Evaporator (Indoor Coil)

CAUTION: Before performing recommended maintenance, be sure main power switch to unit is turned off.

COIL – Lift or remove unit top cover for access to indoor coil. See Fig. 10. Inspect coil periodically. Clean as described under Condenser (Outdoor Coil) below.

Condensate Drain – Clean condensate drain trap with bottle brush, then flush condensate pan beneath evaporator coil with clean water. Ensure water flows freely thru condensate drain.

INDOOR FAN WHEEL should be centered in fan housing. To adjust fan, remove fan motor orifice assembly as described below. Loosen setscrew holding fan to motor shaft. Adjust fan and retighten setscrew.

Indoor Fan Removal – See Fig. 10. Disconnect fan motor wiring. Remove sheet metal screws (6) holding fan orifice in place. Remove fan motor bracket mounting screws (3). Slide out complete fan, motor and orifice assembly.

Cleaning Indoor Fan Wheel – Remove caked-on dirt from fan wheel and housing with brush; remove grease with mild solvent. When replacing blower assembly, ensure fan wheel is centered in housing.

Condenser (Outdoor Coil)

COIL – Lift or remove top cover for access to outdoor coil. See Fig. 10. Inspect coil periodically. Clean coil with water at the beginning of every cooling season or more often if required. Use ordinary garden hose at a pressure high enough to clean efficiently. For best results, spray coil fins from inside-to-outside the unit or top to bottom between rows of tubing. Flush dirt from base pan by spraying water thru top of unit. Avoid splashing mud on coil or water on the fan motor.

OUTDOOR FAN POSITION – Required fan position is shown in Fig. 11. Adjust fan by loosening setscrews and moving blades up or down.

OUTDOOR FAN AND MOTOR REMOVAL – Remove screws holding outdoor coil fan grille in place. Disconnect fan motor leads from controllers and capacitor. Lift complete fan, motor and orifice assembly (Fig. 10) out of unit. After replacing fan motor assembly, reconnect fan motor leads.

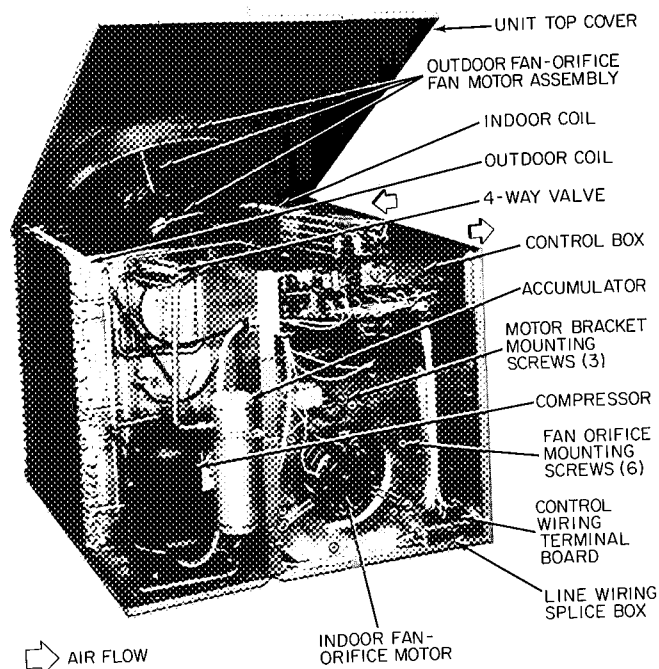

Fig. 10 – Component Location

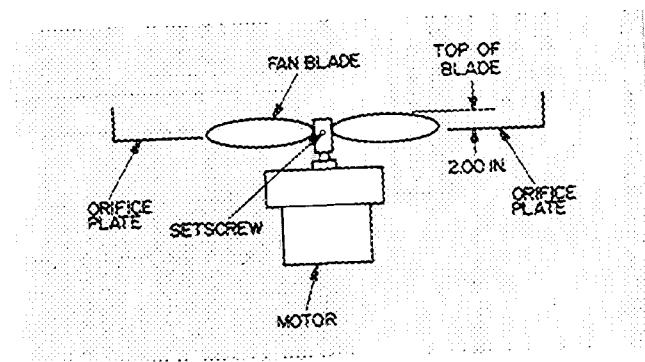
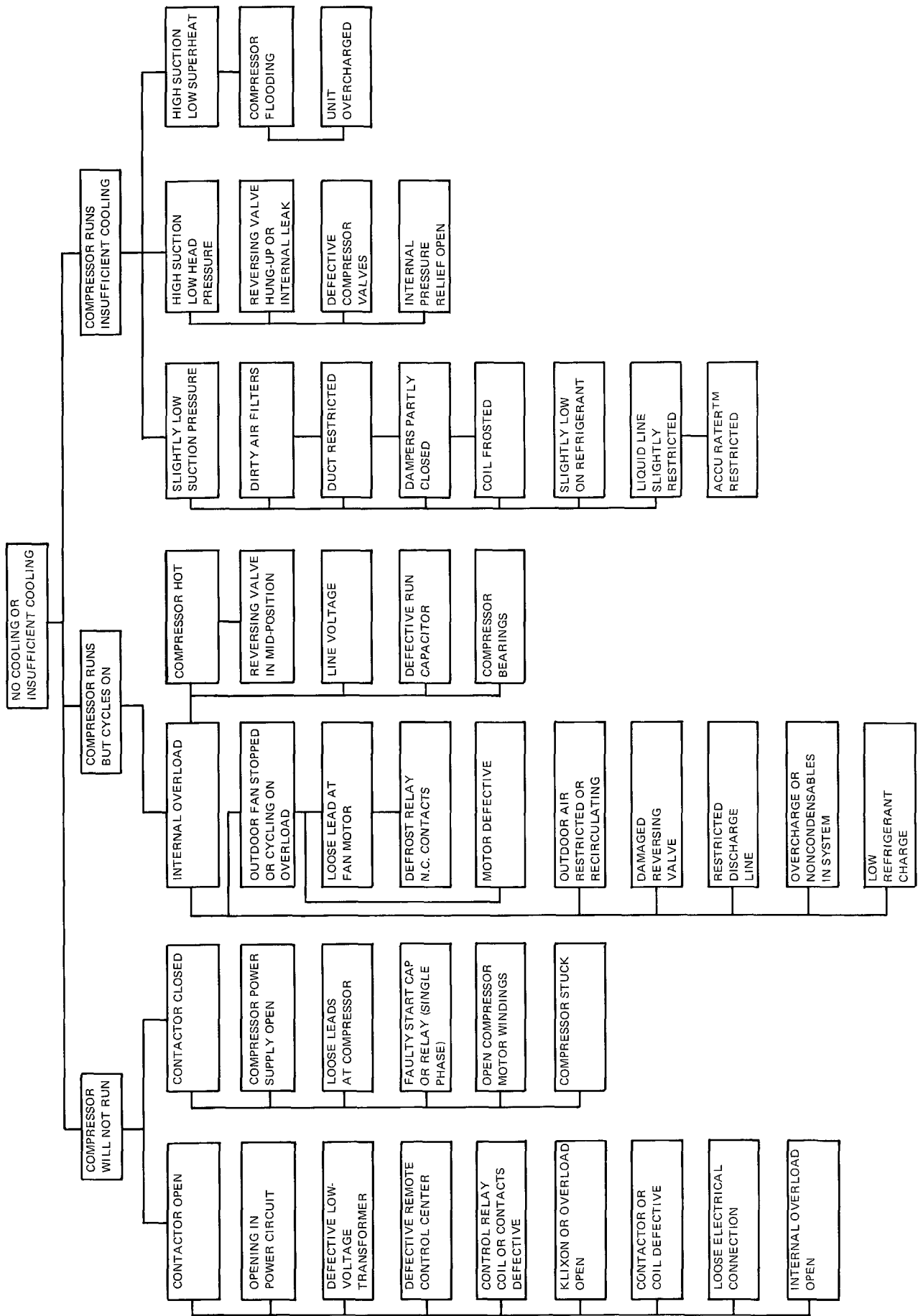

Fig. 11 – Outdoor Fan Position

Return Air Filter (Field Supplied) – Replace throwaway filter twice a year. Clean permanent-type filter a minimum of twice yearly. Flush permanent filter with hot water, steam or soak in mild solution of soap or detergent and water. Allow filters to dry and replace. Refer to filter manufacturer's instructions, as required, for other types of filters.

TROUBLESHOOTING CHART — COOLING CYCLE



TROUBLESHOOTING CHART — HEATING CYCLE

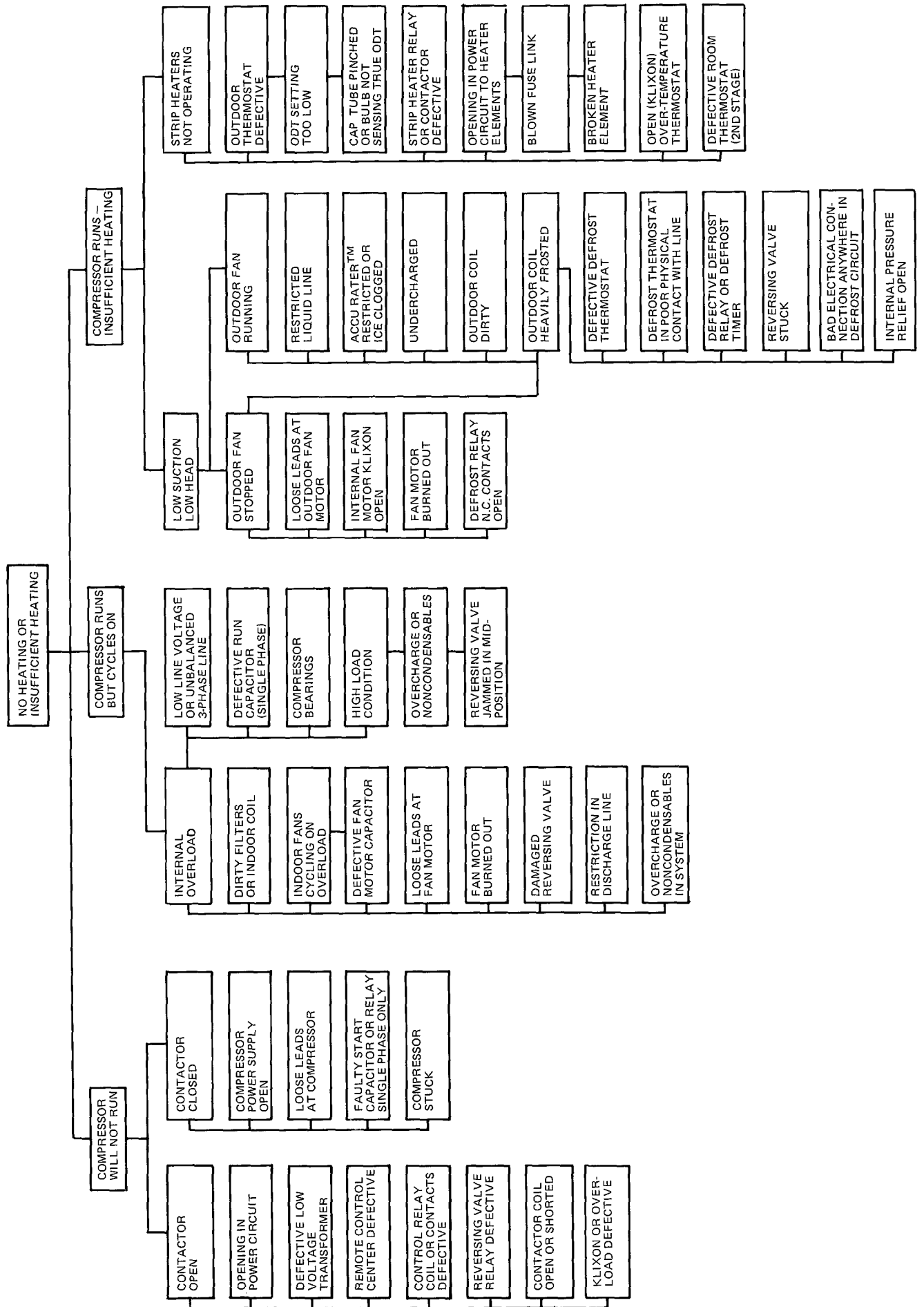

For replacement items use Carrier Specified Parts.

Manufacturer reserves the right to discontinue, or change at any time, specifications or designs without notice and without incurring obligations.

Free Manuals Download Website

<http://myh66.com>

<http://usermanuals.us>

<http://www.somanuals.com>

<http://www.4manuals.cc>

<http://www.manual-lib.com>

<http://www.404manual.com>

<http://www.luxmanual.com>

<http://aubethermostatmanual.com>

Golf course search by state

<http://golfingnear.com>

Email search by domain

<http://emailbydomain.com>

Auto manuals search

<http://auto.somanuals.com>

TV manuals search

<http://tv.somanuals.com>