

# CASIO®

# Handheld Terminal IT-300 Series

## User's Guide

Be sure to read "Safety Precautions" inside this guide before trying to use your Handheld Terminal.

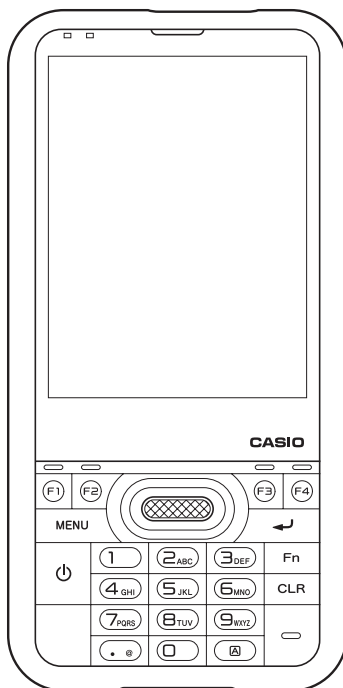

---

## **Bluetooth®**

- BLUETOOTH is a registered trademark owned by Bluetooth SIG, Inc. and licensed to CASIO COMPUTER CO., LTD.
- Microsoft and Windows are either registered trademarks or trademarks of Microsoft Corporation in the United States and/or other countries.

Information in this document is subject to change without advance notice. CASIO Computer Co., Ltd. makes no representations or warranties with respect to the contents or use of this manual and specifically disclaims any express or implied warranties of merchantability or fitness for any particular purpose.

# Contents

---

<b>Safety Precautions .....</b>	<b>E-3</b>
<b>Operating Precautions .....</b>	<b>E-8</b>
<b>Important .....</b>	<b>E-10</b>
<b>Regulatory Information .....</b>	<b>E-11</b>
<b>Checking in the Box .....</b>	<b>E-13</b>
<b>Handheld Terminal System Configuration .....</b>	<b>E-14</b>
<b>General Guide .....</b>	<b>E-16</b>
IT-300 .....	E-16
USB and Charging Unit .....	E-19
<b>Loading and Removing the Battery Pack.....</b>	<b>E-20</b>
Loading .....	E-21
Removing .....	E-22
<b>Handling the USB and Charging Unit (HA-J65US).....</b>	<b>E-23</b>
Mounting the USB and Charging Unit .....	E-23
Removing the USB and Charging Unit.....	E-24
Using the optional cable (HA-J81USBH).....	E-24
Connecting to a Computer .....	E-25
<b>Charging the Battery Pack .....</b>	<b>E-26</b>
AC Adaptor (optional) .....	E-26
Dual Battery Charger (optional).....	E-27
<b>Attaching the Neck Strap.....</b>	<b>E-28</b>
To attach the neck strap.....	E-28
<b>Using the Touch Panel .....</b>	<b>E-29</b>
<b>Setting the Display Brightness.....</b>	<b>E-30</b>
Adjusting Display Brightness .....	E-30
Display Auto Dimmer .....	E-30
<b>Using the Laser Scanner.....</b>	<b>E-31</b>
Bar Code Scanning Position .....	E-32
<b>Adjusting the Laser Light Emission Width .....</b>	<b>E-33</b>
<b>Handling microSD Cards .....</b>	<b>E-35</b>
Installing.....	E-35
Removing .....	E-36

---

<b>Performing Bluetooth® Communication.....</b>	<b>E-37</b>
<b>Resetting the Handheld Terminal.....</b>	<b>E-38</b>
Performing a Full Reset (Initialization) .....	E-38
<b>Warning Label .....</b>	<b>E-40</b>
<b>Using the Dual Battery Charger (HA-D32DCHG).....</b>	<b>E-41</b>
General Guide .....	E-41
Charging a Battery Pack.....	E-43
Connecting Multiple Dual Battery Chargers.....	E-44
Specifications .....	E-45
<b>Using Rechargeable Battery Pack.....</b>	<b>E-46</b>
Battery Pack Specifications.....	E-46
<b>Specifications .....</b>	<b>E-47</b>
IT-300.....	E-47
USB and Charging Unit .....	E-49

# Safety Precautions

---

Congratulations upon your selection of this CASIO product. Be sure to read the following Safety Precautions before trying to use it for the first time.

Your neglect or avoidance of the warning and caution statements in the subsequent pages causes the danger of fire, electric shock, malfunction and damage on the goods as well as personal injury.

## Markings and Symbols

The following are the meanings of the markings and symbols used in these Safety Precautions.



### **Danger**

This symbol indicates information that, if ignored or applied incorrectly, creates the danger of death or serious personal injury.



### **Warning**

This symbol indicates information that, if ignored or applied incorrectly, creates the possibility of death or serious personal injury.



### **Caution**

This symbol indicates information that, if ignored or applied incorrectly, creates the possibility of personal injury or property damage.

---



- A diagonal line indicates something you should not do. The symbol shown here indicates you should not try to take the unit apart.



- A black circle indicates something you should do. The symbol shown here indicates you should unplug the unit from the wall outlet.



## **Warning**

### **Disassembly and Modification**



- Never try to disassemble or modify the Handheld Terminal and its options including battery pack and battery in any way.

### **Abnormal Conditions**



- Should the Handheld Terminal and/or its options including battery pack and battery become hot or start to emit smoke or a strange odor, immediately turn off the power and contact your dealer or distributor whom you purchased the product from, or an authorized CASIO service provider.

---

## **Warning**

### **Dust and Moisture**



- Though the Handheld Terminal is dust and water splash resistant, its options including the battery pack are not. Keep loose metal objects and containers filled with liquid away from your Handheld Terminal and the options. Also, never handle the Handheld Terminal and the options while your hands are wet.

### **Laser Light**



- The laser scanner models (model dependant) with the integrated laser scanning module scan bar codes using laser light. Never look directly into the laser light or shine the laser light into the eyes.

## **Warning**

### **Interference with the Operation of Other Equipment (Using Wireless Data Communication)**



- Keep your Handheld Terminal at least 22 centimeters (8<sup>11</sup>/<sub>16</sub>" ) away from anyone wearing a pacemaker. Radio waves emitted by the Handheld Terminal can affect the operation of a pacemaker.
- Before the use in aircraft, be sure to consult with cabin crew for interference the Handheld Terminal emits.
- Before the use in medical facility, be sure to consult with the facility management or the manufacture of a specific medical equipment that the Handheld Terminal may interfere with.
- Do not use the Handheld Terminal nearby gas pump or chemical tank or any other places flammable or explosive.
- To comply with the relevant European RF exposure compliance requirements, a separation distance of at least 3.8cm in wireless operation must be maintained between the terminal and all persons around. This terminal must not be co-located or operating in conjunction with other transmitter.



## Caution

### Foreign Objects

-  • Take care to ensure that metals or combustible objects are not inserted into the openings of the Handheld Terminal or its options, and not to allow moisture to get inside of them.

### Location



-  • Install the cradle properly on a flat and stable surface so that it cannot fall down onto floor.

### LCD Screen



-  • Never apply strong pressure to the screen or subject it to strong impact. Doing so can crack the LCD Screen.

## Optional Lithium-ion Battery Pack

### **Danger**

-  • Never use the Handheld Terminal and its option including the battery pack and battery next to open flame, near a stove, or any other area exposed to high heat, or leave them for a long period of time in a vehicle parked in direct sunlight.
- Never use the battery pack with any device other than the Handheld Terminal.
- Never dispose of the battery pack by incinerating it or otherwise expose it to heat.
- Never transport or store the battery pack together with metal objects that may result in shorting positive (+) and negative (-) terminals of the battery pack. Be sure to place the battery pack in its case whenever transporting or storing it.
- Never throw the battery pack or otherwise subject it to strong impact.
- Never pierce the battery pack with nails, hit it with a hammer, or step on it.
-  • Use only the specified battery charger to charge the battery pack.

### **Warning**

-  • Never place the battery pack in a microwave oven or any other high-voltage device.
-  • If the amount of time period the battery pack can serve becomes considerably short even after it has been fully charged for the specified time period, stop using it.
- Should the battery pack start to leak or emit a strange odor, immediately move it away from any flame nearby. Leaking battery fluid is combustible.
- Should fluid from the battery pack accidentally get into your eyes or on the skin, do not rub it. Immediately rinse it off with clean tap water and then consult a physician.



### **Caution**

-  • Replace only with the same type of battery pack recommended by CASIO. Dispose of used battery packs according to the local regulation.
- Keep the battery pack out of the reach of small children.







## Power Supply / AC Adaptor

### **Warning**

-  Do not use the Handheld Terminal at a voltage other than the specified voltage. Also, do not connect the Handheld Terminal to a multi-plug power strip.
- Never modify, sharply bend, twist, or pull on the power cord.
- Never use a detergent to clean AC adaptor and its power cable, especially on the plug and the jack.
-  When using the battery chargers and the cradles, be sure to use the respective AC adaptors.

### **Caution**

-  Never pull on the power cord when unplugging it. Always hold the plug when unplugging it from the wall outlet.
- Never touch the plug while your hands are wet.
-  Be sure to unplug the power cord from the wall outlet before cleaning the battery chargers and the cradles.
- Unplug the power cord from the wall outlet whenever leaving the battery chargers and the cradles unattended for a long period.
-  The housing of the AC adaptor can become warm during normal use.
-  At least once a year, unplug the AC adaptor from the wall outlet and clean any dust that builds up between the prongs of the plug. Dust built up between the prongs can lead to the danger of fire.

## Backup of All Important Data

### **Caution**

-  Note that CASIO Computer Co., Ltd. shall not be held liable to you or any third party for any damages or loss caused by deletion or corruption of data due to use of the Handheld Terminal, malfunction or repair of the Handheld Terminal or its peripherals, or due to the batteries going dead.
- The Handheld Terminal employs electronic memory to store data, which means that memory contents can be corrupted or deleted if power is interrupted due to the batteries going dead or incorrect battery replacement procedures. Data cannot be recovered once it is lost or corrupted. Be sure to make backup of all important data. One way to do this is to use the separately sold cradles to transfer data to a computer.

# Operating Precautions

---

Your Handheld Terminal and its options are precision. Improper operation or rough handling can cause problems with data storage and other problems. Note and observe the following precautions to ensure proper operation.

- **Do not leave dead battery pack in the Handheld Terminal for a long period.**

Dead battery pack can leak, leading to malfunction and damage to the Handheld Terminal.

- **Stop or avoid using the Handheld Terminal and its options in areas and conditions subject to the following.**

- Large amounts of static electricity
- Extreme heat or cold or humidity
- Sudden temperature change
- Large amount of dust
- After large amount of rain or water falls on the Handheld Terminal
- Pressing the screen or keys with excessive force when using in the rain

- **Use the touch panel by touching it lightly with your finger.**

Do not press down hard on the touch panel or press it with pointed objects (ballpoint pens, fingernails, etc.) as this could scratch or damage the touch panel and lead to malfunctions.

- **The touch panel may not operate correctly in the following situations:**

- When a foreign object is stuck to or touching the panel
- When a sticker or protective sheet other than the special sheet provided is stuck to the touch panel
- When your finger or the touch panel is wet
- When you use it while wearing gloves

- **Dead Pixels**

The LCD panel employed in this product uses high precision and substantial number of components which commonly cause a small number of the pixels not to light or to remain lit all the time. This is due to the characteristics of LCD panel yield in accuracy over 99.99% and permissible.

---

### • Lithium-ion Battery Pack

Each lithium-ion battery pack has its life. The life span heavily depends on how the battery pack is charged or stored which may cause deterioration of the battery pack to shorten the life span if it is handled improperly. Note the tips below to make the battery pack last long.

- Be sure to charge the battery pack before using it if the battery pack is used for the first time or if it has not been used for a long period of time.
- If the battery pack is repeatedly charged, the life span becomes short. To avoid the repetition of charging the battery pack, be sure that the remaining capacity is low before you start charging.
- Be sure to charge the battery pack in recommended temperature range. The temperature range is dependant on device you use to charge including battery chargers and handheld terminals. Refer to the respective user guides. Charging the battery pack in a temperature outside of the recommended range causes deterioration.
- When used at low temperatures, the battery pack has a reduced capacity and will supply power for shorter time.  
The life span of the battery pack is also shortened.
- Charging the battery pack while the battery pack itself is freeze including inside causes deterioration. Be sure to resume an ordinary room temperature on the battery pack and then leave it unattended for approximately one hour before charging.
- After charging the battery pack, if the performance of the battery pack does not show any recovery, it is a sign of ending the life. Replace it with a new battery pack.
- Avoid the battery pack with a full of the capacity to store for a long period of time. If you need to store it for a long period, be sure that the remaining capacity is 30 to 50 percent and to store in a moderate low temperature. This can reduce deterioration.
- The battery pack gradually deteriorates over time. In particular, storing (or using) the fully charged battery pack at high temperatures tends to accelerate battery pack deterioration.

# Important

---

- This guide does not include any information about programming and download procedures. See the applicable separate documentation for information about the procedures.

## After Service

- Should this product ever malfunction, contact your original retailer providing information about the product name, the date you purchased it, and details about the problem.



This mark applies to EU countries and Turkey only.

# Regulatory Information

## The USA and Canada

**GUIDELINES LAID DOWN BY FCC RULES FOR USE OF THIS UNIT IN THE U.S.A. (not applicable to other areas).**

### NOTICE

This equipment has been tested and found to comply with the limits for a Class B digital device, pursuant to Part 15 of the FCC Rules. These limits are designed to provide reasonable protection against harmful interference in a residential installation. This equipment generates, uses and can radiate radio frequency energy and, if not installed and used in accordance with the instructions, may cause harmful interference to radio communications. However, there is no guarantee that interference will not occur in a particular installation. If this equipment does cause harmful interference to radio or television reception, which can be determined by turning the equipment off and on, the user is encouraged to try to correct the interference by one or more of the following measures:

- Reorient or relocate the receiving antenna.
- Increase the separation between the equipment and receiver.
- Connect the equipment into an outlet on a circuit different from that to which the receiver is connected.
- Consult the dealer or an experienced radio/TV technician for help.

### FCC WARNING

Changes or modifications not expressly approved by the party responsible for compliance could void the user's authority to operate the equipment.

Proper connectors must be used for connection to host computer and/or peripherals in order to meet FCC emission limits.

### Caution Exposure to radio frequency radiation (below is for portable device)

To comply with FCC RF exposure compliance requirements, this device must not be co-located or operating in conjunction with any other antenna or transmitter.

### Declaration of Conformity



Model Number: HA-J65US  
Trade Name: CASIO  
Responsible party: Industrial Handheld Division  
Casio America, Inc.  
Address: 570 Mt. Pleasant Avenue, Dover, New Jersey 07801, USA  
Telephone number: 973-361-5400

This device complies with Part 15 of the FCC Rules. Operation is subject to the following two conditions:  
(1) This device may not cause harmful interference, and (2) this device must accept any interference received, including interference that may cause undesired operation.

### For Users in Canada

These Class B digital apparatuses comply with Canadian ICES-003.

Cet appareil numérique de la classes B est conforme à la norme NMB-003 du Canada.

These devices comply with RSS 210 of Industry Canada (IC).

Operation is subject to the following two conditions:

- (1) These devices may not cause interference, and
- (2) These devices must accept any interference, including interference that may cause undesired operation of this device.

---

L'utilisation de ce dispositif est autorisée seulement aux conditions suivantes :

- (1) il ne doit pas produire de brouillage et
- (2) l'utilisateur du dispositif doit être prêt à accepter tout brouillage radioélectrique reçu, même si ce brouillage est susceptible de compromettre le fonctionnement du dispositif.

Exposure to radio frequency radiation

The installer of this radio equipment must ensure that the antenna is located or pointed such that it does not emit RF field in excess of Health Canada limits for the general population; consult Safety Code 6, obtainable from Health Canada's website at [http://www.hc-sc.gc.ca/ewh-semt/pubs/radiation/99ehd-dhm237/index\\_e.html](http://www.hc-sc.gc.ca/ewh-semt/pubs/radiation/99ehd-dhm237/index_e.html)

## Europe

Products are for distribution within  
all member states of the EU.

**CE 0984** 

France limited to 2446.5-2483.5 MHz Indoor use.

Belgium limited to 2400-2483.5 MHz Indoor, 2460-2483.5 MHz Outdoor use.

Optional models HA-J65US, HA-D32DCHG and HA-D20BAT-A are in conformity with the Council Directive 2004/108/EC.

 Manufacturer:  
CASIO COMPUTER CO., LTD.  
6-2, Hon-machi 1-chome, Shibuya-ku, Tokyo 151-8543, Japan  
Representative within the European Union:  
CASIO EUROPE GmbH  
Casio-Platz 1, 22848 Norderstedt, Germany

# Checking in the Box

---

Please check the contents of the box before using the Handheld Terminal for the first time.

Open the box and make sure that all the items shown here are included.

## Handheld Terminal

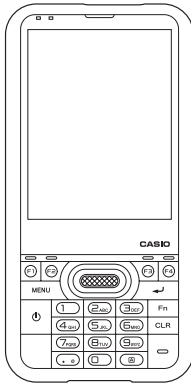

## USB and Charging Unit (HA-J65US)

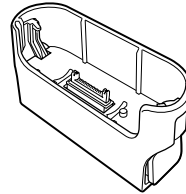

## Battery Pack (HA-D20BAT-A)

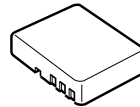

## Cable (HA-J80USBM)

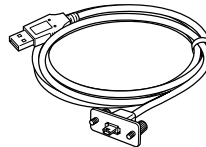

## Neck Strap

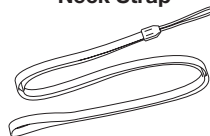

## User's Guide (this manual)

A USB Power Adaptor is provided with models to be sold in China.

# Handheld Terminal System Configuration

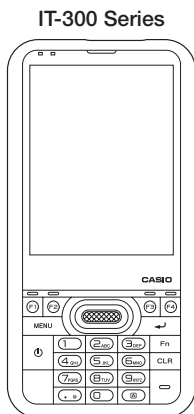

## Options

### Battery Pack

HA-D20BAT-A

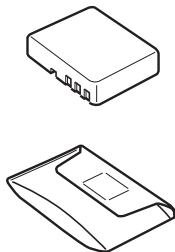

### Dual Battery Charger

HA-D32DCHG

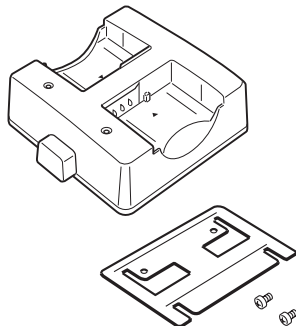

### AC Adaptor for Dual Battery Charger

AD-S42120B-N

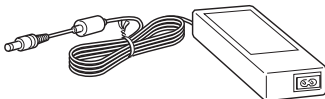

### AC Adaptor for USB and Charging Unit

AD-S15050B-N

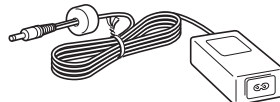

**Power Cord for Europe** AC-CORD-EU

**Power Cord for North America** AC-CORD-US

**Power Cord for Taiwan** AC-CORD-TW

**Power Cord for Korea** AC-CORD-KR

**Power Cord for Australia** AC-CORD-AU

For the latest options list, refer to the ON-LINE manual available at  
[http://world.casio.com/system/pa/UsersGuide/sup85\\_e.html](http://world.casio.com/system/pa/UsersGuide/sup85_e.html)



Options

**USB and Charging Unit**

HA-J65US

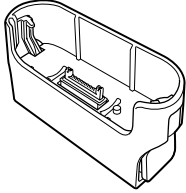

**Cables**

HA-J80USBM

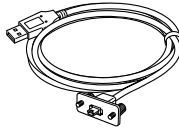

HA-J81USBH

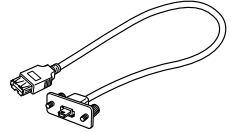

**Screen Protect Sheet**

HA-J90PS5

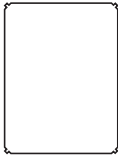

# General Guide

## IT-300

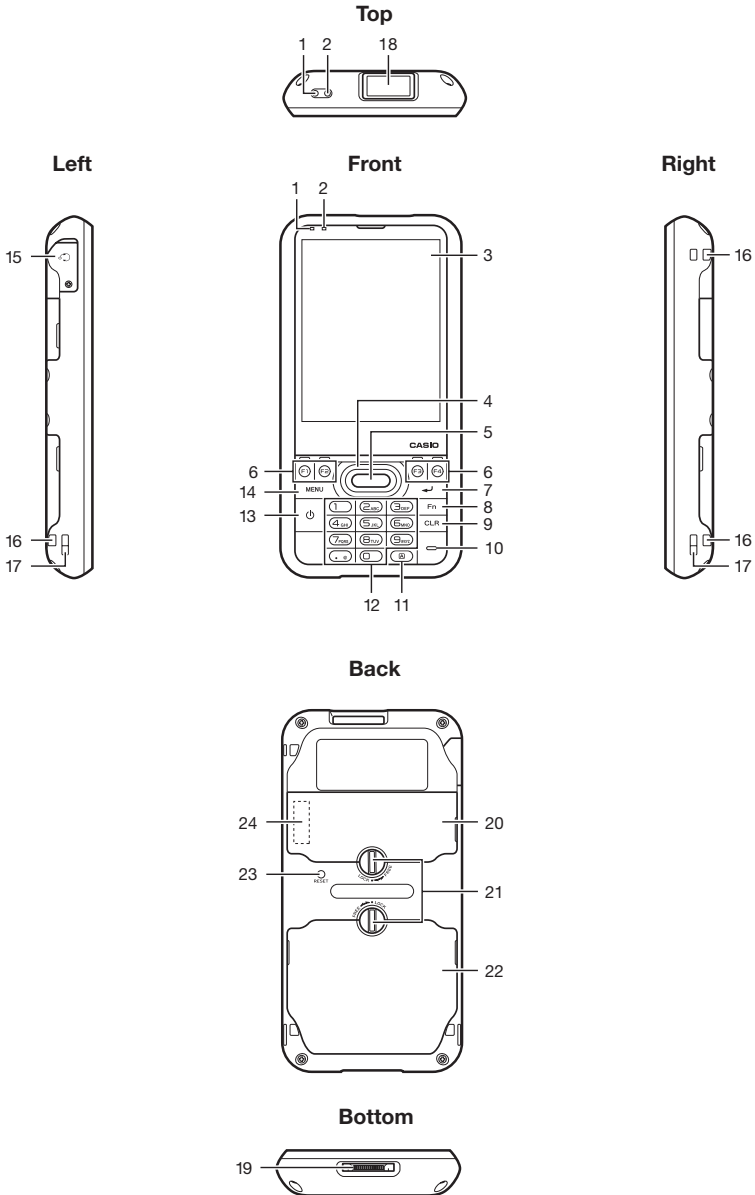

1	Indicator 1	Orange: Charging Green: Charging complete Red Flashing: Battery pack error or the surrounding temperature is out of the charging temperature range
2	Indicator 2	Blue Flashing: BT in use Orange Flashing: WLAN in use Magenta Flashing: Ready to communicate (when USB-connected) Red: Barcode read error Green: Successful read Lights red for alarm functions.
3	Touch Panel	Displays texts, operations, indicators and so forth. Also used to operate the IT-300 and enter data by tapping the screen with a fingertip.
4	Cursor Key	Perform the same functions as the up, down, left and right arrow keys on a PC keyboard.
5	Trigger Key	Used to perform bar code reading. Can be assigned an arbitrary function.
6	Function Keys	Used when starting a pre-registered application.
7	Enter Key	Press when finishing entering numerical values or when moving to the next step.
8	Fn Key	Used to make various settings in combination with the numeric keys or when starting a pre-registered application.
9	CLR Key	Press to clear all the information entered by pressing keys.
10	Microphone	Used for audio input (including voice).
11	Mode Key	The key switches the character input mode, either characters in lowercase letter or characters in uppercase letter.
12	Numeric Keys	Press to enter numbers and text.
13	Power Key	Turns the power on and off.
14	MENU Key	Displays menus for applications.
15	Headset Jack	Used to connect an earphone-microphone headset.
16	Strap Holes	Used to attach neck strap.
17	USB and Charging Unit Mount Holes	Used to attach the USB and Charging Unit.
18	Barcode Reader	Laser light or LED light is emitted from this window that reads bar codes.
19	Power Supply/Data Communication Terminals	Used to connect the USB and Charging Unit for USB communication or power supply.

---

20	microSD Card Slot Cover	Slot a microSD card into here.
21	Lock Switches	Used to lock the covers and to release.
22	Battery Pack Cover	Used to cover the battery compartment that holds the battery pack inside.
23	Reset Switch	Used to reset the Handheld Terminal.
24	microSD Card Slot	microSD card slot.

## USB and Charging Unit

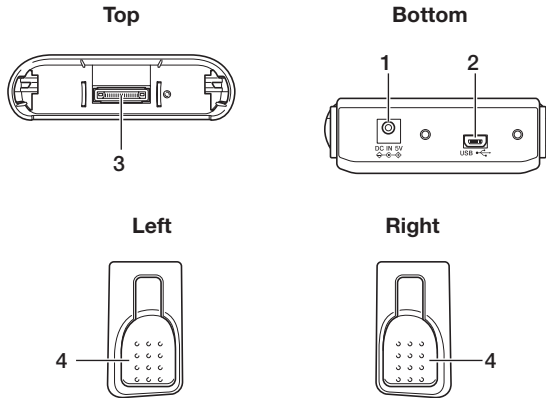

1	AC Adaptor Jack	Connect the AC adaptor here.
2	USB Port	Connect the cable (HA-J80USBM) here.
3	Power Supply/Data Communication Connector	Used to connect to the IT-300 for USB communication or power supply.
4	Stoppers	Press when removing the IT-300.

# Loading and Removing the Battery Pack

---

Your Handheld Terminal uses two types of battery: a battery pack and a memory backup battery.

The battery pack is used to power normal operations and to store data, while the memory backup battery provides the power required to maintain memory contents when the battery pack power is unable to supply power for some reason.

Use the battery pack (HA-D20BAT-A) as the main power source. The backup battery is installed inside of the Handheld Terminal.

## **This guide uses the following terms to refer to the batteries.**

**Battery Pack:** Rechargeable battery pack (HA-D20BAT-A) for normal operations and data storage

**Backup Battery:** Built-in battery for memory backup

When the battery pack power goes low, immediately charge it or replace it with a charged battery pack.

You can use the AC adaptor or the Dual Battery Charger to charge a battery pack installed in the terminal. See the relevant sections in this guide for the respective options about how to use.

## **Important!**

### **Always keep backup of all important data!**

- **The battery pack powers normal operation and also provides power required to maintain memory contents, while the backup battery provides backup power to maintain memory contents. Because of this, you should not remove the battery pack if the backup battery is dead. Removing the battery pack while the backup battery is dead causes data in the memory to be corrupted or lost. Note that once data is lost it cannot be recovered. Always keep backup of all important data.**
- **The charge of a battery pack when you purchase it may be depleted due to testing at the factory or natural discharge during shipment and storage. Be sure to charge the battery pack before you use it.**
- **The life of a battery pack is limited, and charging a battery pack causes it to gradually lose its ability to maintain the charge. If your battery pack seems to require charging very frequently, it probably means it is time to purchase a new one.**
- **If a battery pack is used past the end of its service life, it may swell up in size. In such a case, replace the battery pack with a new one.**
- **If the backup battery is fully charged, it will maintain the contents of the terminal's memory (RAM) for approximately 10 minutes when the main battery pack is removed.**
- **It takes 4 days with the main battery pack installed in the terminal for the backup battery to be charged fully.**

---

## Loading

1. Turn the terminal over, turn the lock switch for the battery pack cover to the “FREE” position (1), and then remove the battery pack cover (2).

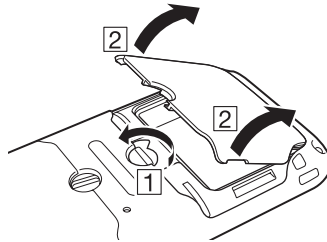

2. Load a battery pack (HA-D20BAT-A). Take care that the battery pack is oriented correctly when you load it. In addition, load the battery pack while making sure that the end of the battery pack removal tape is protruding above the battery pack (3).

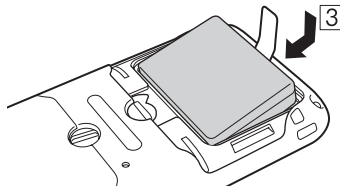

3. Put back the battery pack cover in the compartment as instructed by the arrows, 4 and 5 in the illustration and then turn the lock switch to the “LOCK” position (6).

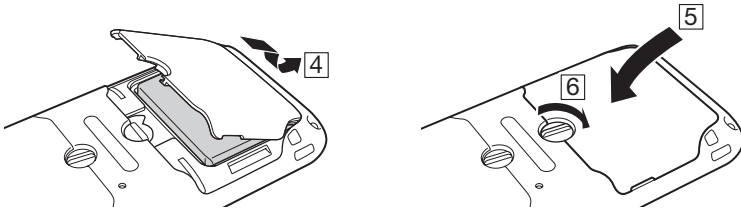

---

## Removing

1. Make sure that the Handheld Terminal is turned off.  
If the power is on, press the power key to turn it off.
2. Turn the terminal over, turn the lock switch for the battery pack cover to the “FREE” position (1), and then remove the battery pack cover (2).

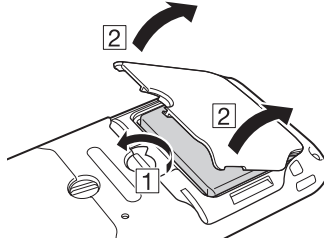

3. Remove the battery pack by pulling up the removal tape as shown in the illustration (3).

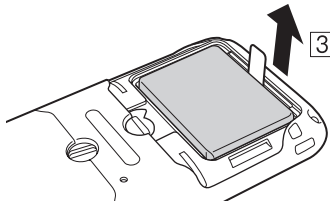

### Important!

- When removing the battery pack, make sure you do not leave the Handheld Terminal without a battery pack for more than about 10 minutes. Doing so can cause data in the memory to be deleted.
- When removing the battery pack, be sure you carefully follow the proper procedure as explained in this guide.
- Never try to use other type of battery than the ones that are specified for this product.
- When removing the battery pack, pull the removal tape straight up and remove the battery pack. Removing with excessive force can damage the battery pack.
- Before starting to use the Handheld Terminal, ensure that the battery pack cover is properly closed. If not, the power is not turned on or is turned off abruptly while it is in use.



# Handling the USB and Charging Unit (HA-J65US)

Mount the USB and Charging Unit on the terminal when using the unit to charge the battery pack in the terminal or when connecting the terminal to another USB device using the optional cable (HA-J81USBH).

## Mounting the USB and Charging Unit

1. Fit the USB and Charging Unit onto the bottom of the terminal as shown in the illustration.

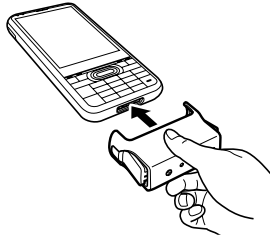

2. After mounting the unit onto the terminal, check that it is firmly locked in place using the stoppers.



### Important!

- The USB and Charging Unit can only be mounted on the terminal in one direction. Do not use excessive force to attempt to push the terminal into the unit when it is facing the wrong way.
- Water or other liquids on the power supply/data communication terminals on the USB and Charging Unit or terminal can lead to an electric shock or fire. Note also that soiling on the terminals will impair the connection, leading to reduced charging functionality. As a safety precaution, disconnect the AC adaptor and USB cable before cleaning the power supply terminals with a dry cloth or cotton bud.
- Never short-circuit the power supply/data communication terminals on the USB and Charging Unit or terminal as this could cause a fault.
- If the neck strap is attached to the terminal, take care not to trap it when mounting the USB and Charging Unit. If you are having difficulties mounting the USB and Charging Unit, attach the neck strap using the strap hole on the top of the terminal.

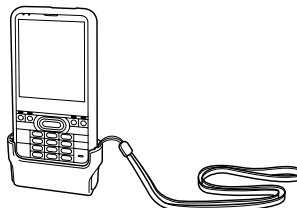

---

## Removing the USB and Charging Unit

1. Unlock the stoppers on the left and right sides of the USB and Charging Unit by pressing them inwards, as shown in the illustration.

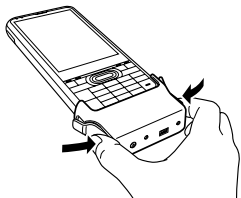

2. Keeping the stoppers pressed in, pull the USB and Charging Unit off the terminal.

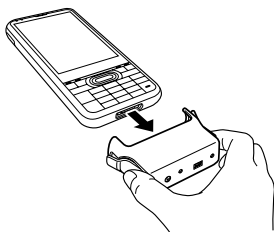

## Using the optional cable (HA-J81USBH)

Plug the cable into the USB and Charging Unit and use it to connect a USB device.

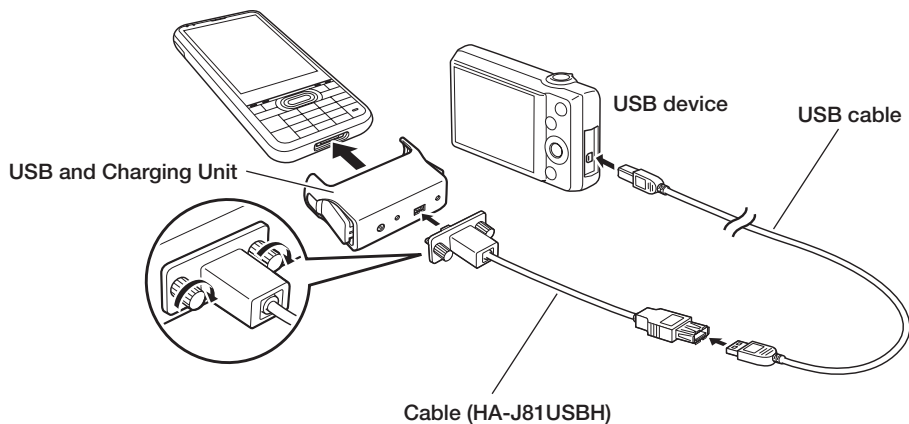

---

## Connecting to a Computer

You can use the USB and Charging Unit together with the cable (HA-J80USBM) to connect the IT-300 to a computer and exchange data via USB. This combination can also be used to charge the battery pack installed in the IT-300 using power supplied from the computer.

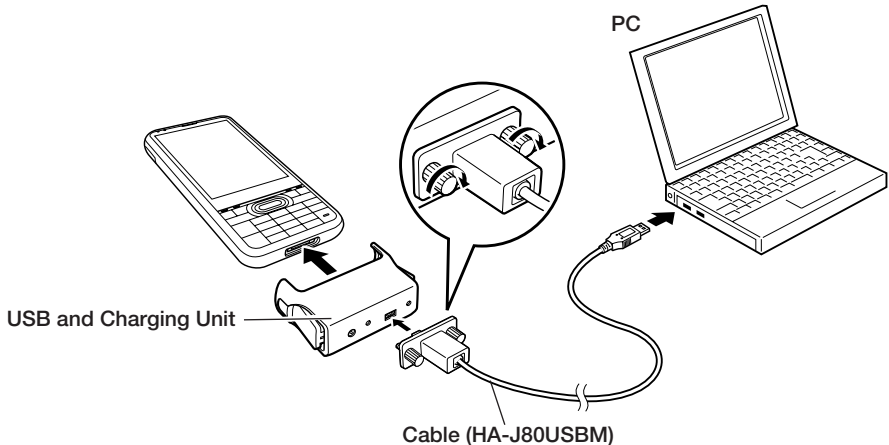

### Status of Indicator 1 on IT-300:

Orange: Charging

Red Flashing: Standby due to battery pack error or the surrounding temperature is out of the charging temperature range  
(charging begins when the temperature is within the charging temperature range)

Green: Charging complete

# Charging the Battery Pack

---

The battery pack installed in the IT-300 can be charged using the optional AC adaptor (AD-S15050B). An indicator on the IT-300 shows the level of charge.

You can also charge the battery pack using the optional Dual Battery Charger (HA-D32DCHG).

Note that you can charge the battery pack while the terminal is connected to a computer and transferring data. (Refer to “Connecting to a Computer” on page 25.)

## AC Adaptor (optional)

Use the USB and Charging Unit provided.

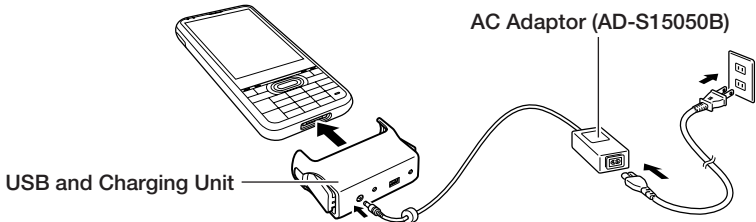

### Status of Indicator 1 on IT-300:

Orange: Charging

Red Flashing: Standby due to battery pack error or the surrounding temperature is out of the charging temperature range  
(charging begins when the temperature is within the charging temperature range)

Green: Charging complete

---

## Dual Battery Charger (optional)

Use the optional AC Adaptor for Dual Battery Charger (AD-S42120B).

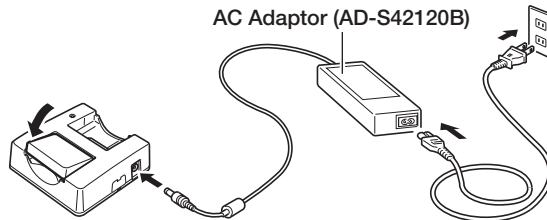

You can connect up to three Dual Battery Chargers.

### Status of Charge Indicator LED

- Off: Not charging
- Red: Charging
- Red Flashing: Battery pack problem
- Green: Charging complete
- Green Flashing: Standby due to the surrounding temperature being beyond the specified temperature range (Approximately 0°- 40°C) (charging resumes when the temperature reaches the range.)

# Attaching the Neck Strap

---

The neck strap can be used to prevent the Handheld Terminal from fall. Since there are three strap holes where the neck strap can be attached, use the hole that affords the greatest ease of use. Attach the neck strap according to the procedure described below.

## To attach the neck strap

1. Pass the thin cord of the neck strap through the strap hole on the back of the Handheld Terminal.

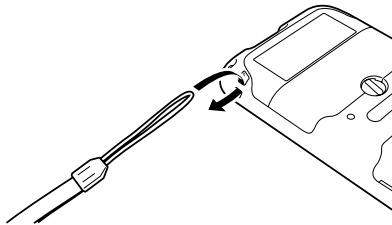

2. Pass the other end of the strap (the part you put around your neck) through the loop formed by the thin cord.

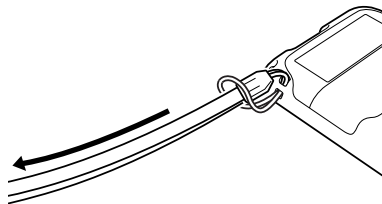
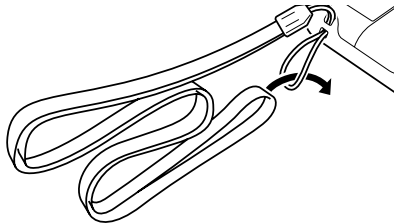

### Important!

**Do not swing the Handheld Terminal around holding the neck strap.**

# Using the Touch Panel

---

Use the touch panel by touching it lightly with your finger. Do not use objects other than your finger.

You can use the touch panel in the following ways:

- Tap: Lightly tap the screen with your finger.
- Touch: Hold your finger against the screen.
- Flick: Move your finger across the screen in a swiping motion.
- Drag: Touch the screen and then move your finger without lifting it from the screen.

# Setting the Display Brightness

---

## Adjusting Display Brightness

You can use the following procedures to adjust display brightness to make it easier to read under different lighting conditions.

- Press the “Fn” key and then press the “5” key or “6” key after confirming that “F” is displayed on the screen. Pressing the “5” key adjusts brightness for a darker display, while pressing the “6” key adjusts brightness for a lighter display.
- \* In order to continue to make adjustments, press the “5” key or “6” key again after first pressing the “Fn” key.
- \* You can set the brightness by tapping “Backlight” in the Control Panel.

## Display Auto Dimmer

The display auto dimmer automatically lowers display brightness if you do not perform any operation for a specific period of time. This helps the battery power to be conserved.

Tap “Backlight” in the Control Panel to set the time delay until the display dims.



# Using the Laser Scanner

---

1. After turning on the power, position the laser scanner close to a bar code and then press the trigger key.



2. The laser emits light and scans the bar code. If scanning is completed normally, Indicator 2 displays a green light.

## **Important!**

- **If you are unable to scan a bar code, try changing the angle at which the scanner is held or distance from the scanner to the bar code, and then try scanning again.**
- **This Handheld Terminal is capable of scanning bar codes at a distance of about 40-400 mm (1<sup>9</sup>/<sub>16</sub>"-15<sup>3</sup>/<sub>4</sub>"). Furthermore, the distance at which scanning is possible may vary according to the bar code symbology.**

## Bar Code Scanning Position

Position the laser scanner close to the bar code when scanning small bar codes.

Position the laser scanner at a distance from the bar code so that the bars enter the light when scanning large bar codes.

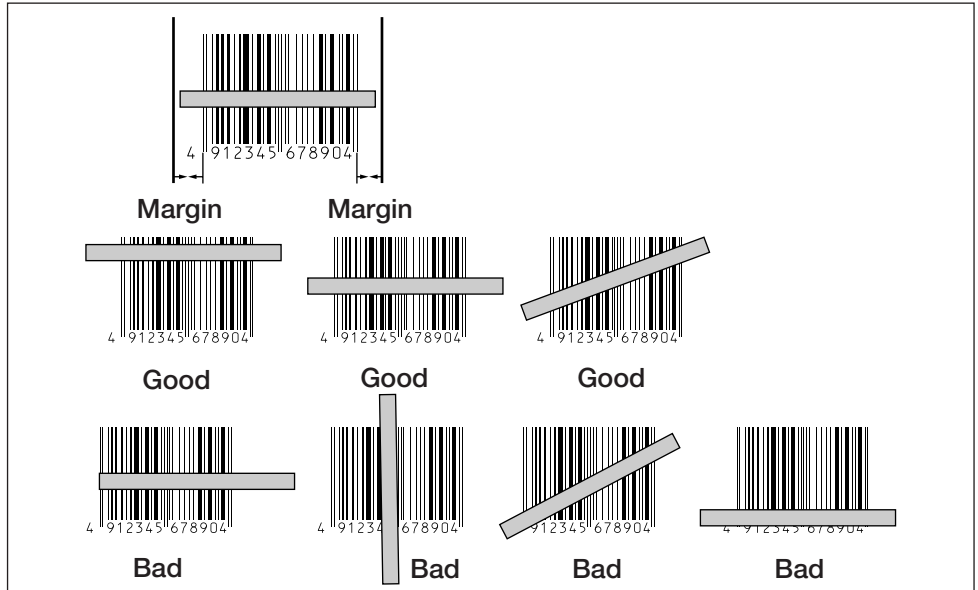

### Warning!

#### ■ Never look directly into the laser light.



- The products with the integrated Laser Scanner module scan bar codes using laser light. Never look directly into the laser light or shine the laser light into the eyes.

# Adjusting the Laser Light Emission Width

The emission width of the laser light emitted by the Handheld Terminal (model dependant) can be adjusted. Adjust the emission width when it is improper.

1. Navigate to the menus in the following sequence:

 → Settings → System

The Control Panel appears as shown in the screen.

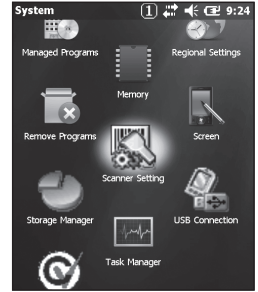

2. Tap the [Scanner Setting] icon. The Setting screen appears as shown in the screen.

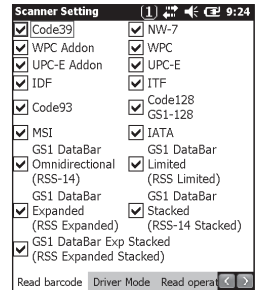

3. Tap the [Others] tab in the Scanner Setting screen.

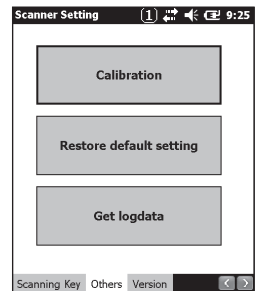

4. Tap the [Calibration] button. The display appears as shown at right.

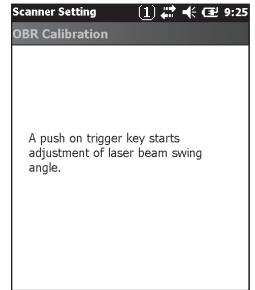

5. Press the trigger key to emit laser light, and align the light with the barcode for adjusting emission width.
- Align the laser light with the narrow bars on both sides.
  - The message appears as shown at right when adjustment is completed.
  - Repeat the setting if "Setting failed" message appears.

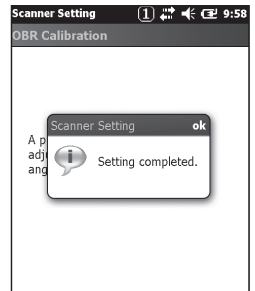

## Emission Width Adjustment Bar code

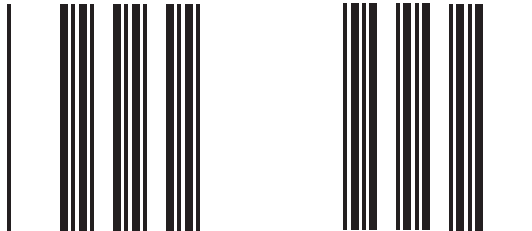

# Handling microSD Cards

---

The Handheld Terminal supports microSD card.

Install (or remove) a microSD card according to the procedure described below.

## Installing

1. Turn the terminal over, turn the lock switch for the microSD card slot cover to the “FREE” position, and then remove the microSD card slot cover.

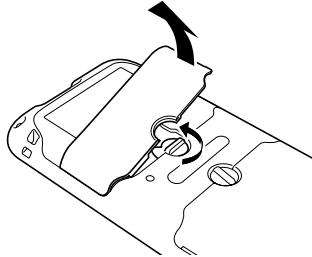

2. Insert microSD card with the description side face up.
  - Insert the card firmly all the way into the slot.
  - Avoid inserting the card diagonally.

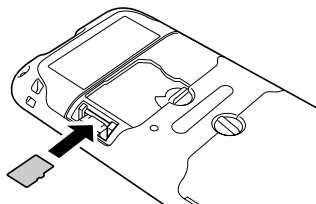

3. Put back the microSD card slot cover and turn the lock switch to the “LOCK” position, as shown in the illustration.

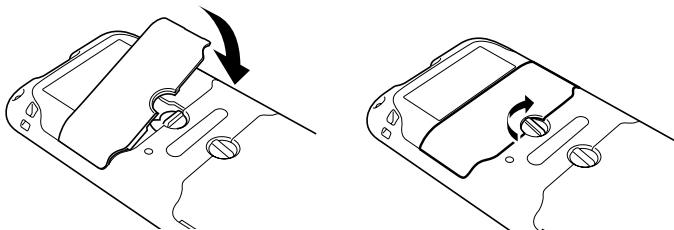

---

## Removing

1. Turn the terminal over, turn the lock switch for the microSD card slot cover to the “FREE” position, and then remove the microSD card slot cover.

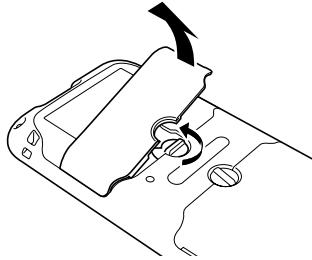

2. Briefly push the microSD card in to release, and then remove, as shown in the illustration.

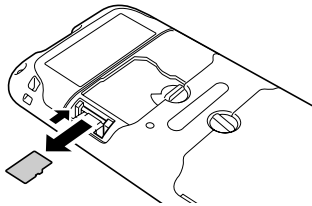

3. Put back the microSD card slot cover and turn the lock switch to the “LOCK” position.

### Important!

- A microSD card must be inserted with the top and bottom properly aligned and in the proper direction. Attempt in inserting it with an excessive force in incorrect orientation can risk damage to the connectors and slot.
- Never turn off the power or remove a microSD card from the slot while the card is being accessed. Doing so can damage the microSD card or data in the card.
- Do not drop the card or lose it.

# Performing Bluetooth® Communication

---

Bluetooth® interface can also be used to transfer data between two Handheld Terminals. With Bluetooth® the two Handheld Terminals should be located within about three meters (9'10<sup>3</sup>/<sub>8</sub>" ) from each other, as long as there is nothing blocking the path between them.

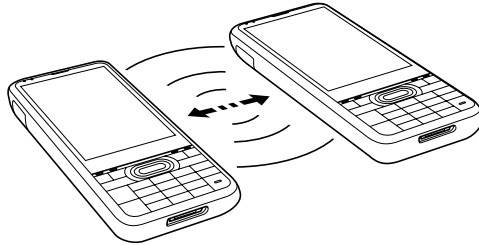

## Important!

Observe the following precautions to help ensure that Bluetooth communication is successful.

- Make sure two Handheld Terminals face each other within three meters (9'10<sup>3</sup>/<sub>8</sub>" ). Surroundings (obstacles) between the Handheld Terminals may cause a shorter distance.
- Make sure there is at least two meters (6'7") between the Handheld Terminal and other equipment (electrical appliances, audio-visual equipment, OA equipment, and digital cordless telephones, facsimile machines, etc.). Take special care with microwave ovens. Allow at least three meters (9'10<sup>3</sup>/<sub>8</sub> ) between the Handheld Terminals in wireless operation and a microwave oven. When operating the terminal in Bluetooth nearby these devices and electrical appliances with their powers being turned on, communication may be interrupted or TV and radio receptions may be interfered (images on the screen produced by certain channels of UHF and broadcast satellite may become blurry).
- Normal communication may not be possible in an area near a broadcast transmitter or wireless transmitter. If this happens, move the Handheld Terminal to a different location. Normal communication may not be possible in areas exposed to strong radio waves.
- Interference by WLAN

Because Bluetooth® and WLAN use the same frequency band (2.4GHz), radio interference can occur if there is a WLAN device nearby. This can result in lower communication speed, or even make it impossible to establish a connection. If this happens, try the following countermeasures.

- Move at least 10 meters (32'10<sup>3</sup>/<sub>4</sub>" ) away from the WLAN device.
- If you cannot keep the distance at least 10 meters (32'10<sup>3</sup>/<sub>4</sub>" ) or more between the Handheld Terminal and a WLAN device, turn off the power of either the Handheld Terminal or the WLAN device.
- Although the Handheld Terminal enables WLAN and Bluetooth® communication to be used simultaneously as a result of being equipped with Bluetooth® Ver.2.0, communication may not be possible depending on the surrounding radio wave environment.

# Resetting the Handheld Terminal

---

Resetting the terminal is the same as resetting a PC. Performing a reset causes all unsaved RAM data to be lost that are in mid-course of inputting and editing, but data and settings that are already stored in the FlashROM should be unaffected. Perform a reset to restore normal operation whenever the Handheld Terminal operates abnormally due to misoperation or some other reason.

**Use a pointed implement such as a mechanical pencil (with the lead retracted) to press the reset switch on the back of the terminal.**

**This starts the reset operation.**

\* Do not use a toothpick or pencil or other sharp object whose tip may break off the reset switch.

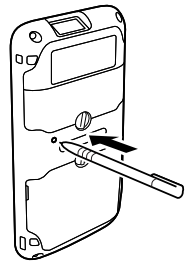

## Performing a Full Reset (Initialization)

Performing a full reset deletes all data and resets various settings to their defaults.

\*Data stored in the Flashdisk folder remain unaffected.

Perform a full reset whenever any one of the following conditions exists.

- When you want to delete installed programs and settings, and resume the terminal to the initial condition.
- When you are no longer able to use the Handheld Terminal because you forgot your password.
- When the Handheld Terminal does not operate normally due to a memory problem.

### Important!

**Performing a full reset resets all data to their defaults except stored in the Flashdisk folder. If possible, backup data of the terminal to a PC or to the Flashdisk folder. The reset procedure and display message appeared on performing the reset is according to the model you operate.**



- 
1. While holding down the Fn key and CLR key, push down the reset switch for about 3 seconds with the tip of a pointed implement such as a mechanical pencil until the message shown below appears on the display.
    - To cancel the full reset operation, press the MENU key.

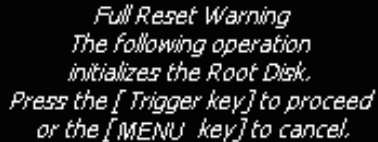

*Full Reset Warning  
The following operation  
initializes the Root Disk.  
Press the [Trigger key] to proceed  
or the [MENU key] to cancel.*

2. Press the Trigger key. This causes the message shown below to appear.
  - To cancel the full reset operation, press the MENU key.

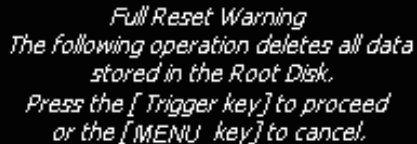

*Full Reset Warning  
The following operation deletes all data  
stored in the Root Disk.  
Press the [Trigger key] to proceed  
or the [MENU key] to cancel.*

3. Press the Trigger key again to perform the full reset.
  - The full reset starts and all data in the memory are erased, and the start-up screen appears.  
Data stored in the Flashdisk folder remain unaffected.

# Warning Label

## Warning!

### ■ Never look directly into the laser light.



- These products scan using laser light. Never look directly into the laser light or shine the laser light into the eyes.

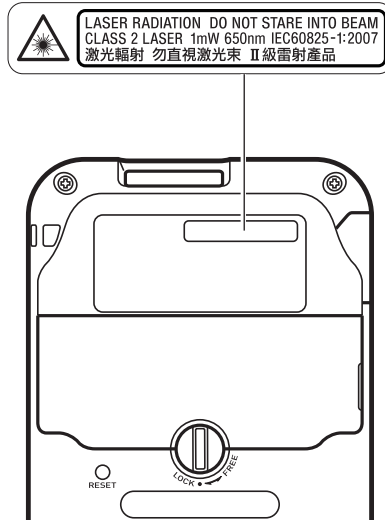

- This label is a warning and caution label for Class 2 laser products that comply with IEC60825-1:2007.
- Although Class 2 laser light is only emitted momentarily, never look directly into the beam light.
- The laser light emitted by this laser scanner has a maximum output of less than 1 mW and a wavelength of 650 nm.
- Use of controls or adjustments or performance of procedures other than those specified herein may result in hazardous radiation exposure.

# Using the Dual Battery Charger (HA-D32DCHG)

The optionally available dual battery charger (HA-D32DCHG) can be used to simultaneously charge two battery packs.

## General Guide

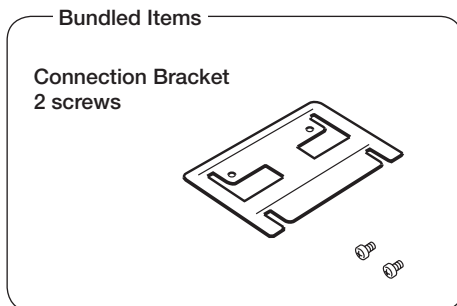
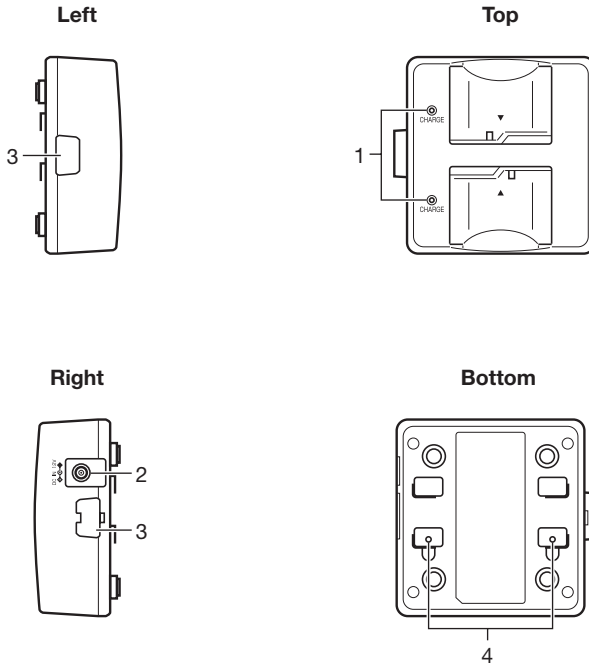

1	Charge Indicator Lamp	This lamp indicates the charge status of the battery pack(s). Off: Not charging Red: Charging Red Flashing: Battery pack problem Green Flashing: Standby Green: Charging complete
2	AC Adaptor Jack	This is used to supply power by connecting the AC adaptor (sold separately).
3	Dual Battery Charger Connection Port	Use this port to connect multiple Dual Battery Chargers to each other.
4	Connection Bracket Attachment Holes	The connection bracket attaches here when you connect multiple Dual Battery Chargers to each other.

### **Important!**

- **Allowing the power contacts become wet can cause an electric shock or fire. In addition, if the contacts become soiled, contact may be impaired resulting in poor charging. For reasons of safety and maintaining charging battery pack(s) in optimum condition, clean the power contacts by wiping with a dry cloth or cotton swab after disconnecting the AC adaptor.**
- **Although the battery may become warm during charging, this is normal and does not indicate a malfunction.**
- **Do not place objects such as a cover over the battery charger while charging.**
- **Do not remove the battery pack or disconnect the AC adaptor during charging.**
- **Repeated “Mounting and Removing” of battery pack in excess of times may cause the quality deterioration of the battery pack.**
- **Each Dual Battery Charger comes with one connection bracket.**
- **Since only one connection bracket is required when you connect two Dual Battery Chargers, you will always have one left over.**
- **Simply keep the other connection bracket on hand as an extra, in case you ever need it.**

---

## Charging a Battery Pack

Use the optionally available AC adaptor (AD-S42120B) for the power supply of the Dual Battery Charger.

1. Plug the cord from the AC adaptor into the AC adaptor jack of the Dual Battery Charger.
2. Plug one end of power cord into the AC adaptor and the other end to a wall outlet.

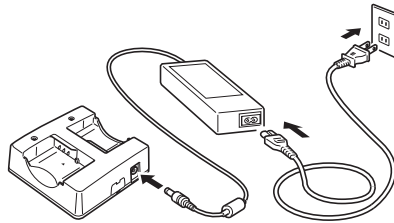

3. Taking care that the battery pack is oriented correctly, insert it into the Dual Battery Charger.

This causes the Charge Indicator Lamp to light in red, indicating that charging has started.

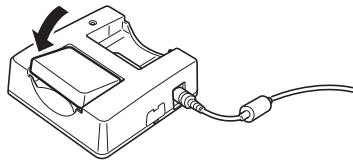

### Charge Indicator Lamp

Off:	Not charging
Red:	Charging
Red Flashing:	Battery pack problem
Green:	Charging complete
Green Flashing:	Standby due to the surrounding temperature being beyond the specified temperature range (Approximately 0°- 40°C) (charging resumes when the temperature reaches the range.)

---

## Connecting Multiple Dual Battery Chargers

You can connect up to three Dual Battery Chargers. Doing so makes it possible to supply power to all the Dual Battery Chargers using one dedicated AC adaptor.

1. As shown in the illustrations below, remove the connector covers of the Dual Battery Chargers you want to connect to each other.

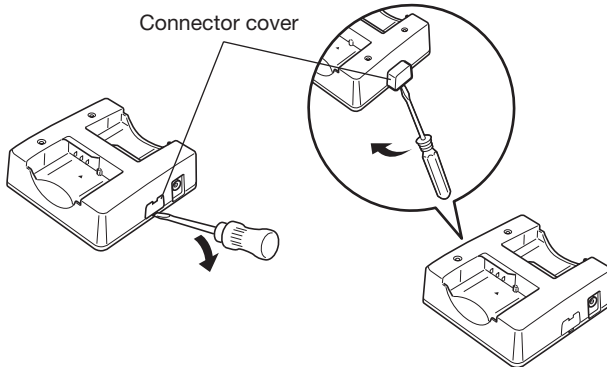

2. Connect the two Dual Battery Chargers as shown below.

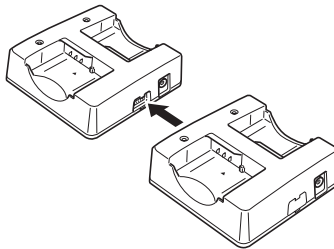

3. Turn over the connected Dual Battery Chargers and attach a connection bracket, securing it in place with screws.

You can repeat the above steps to connect up to 3 Dual Battery Chargers.

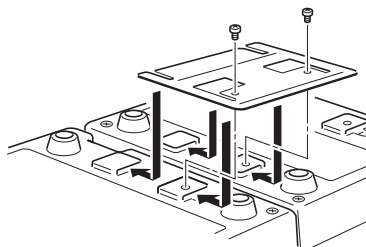

## Specifications

- 1. Model:** HA-D32DCHG
- 2. Charging:**
  - Charging Method: Constant voltage (with current limiter)  
(when one Handheld Terminal has been mounted)
  - Charge Period: Approx. 2 hours (1 battery pack, normal temperature)  
When charging two battery packs:  
Approx. 3.5 hours (2 battery packs, normal temperature)
- 3. Power Supply:**
  - Power Source: AD-S42120B
  - Consumption Current: Approximately 450mA
- 4. AC Adaptor:**
  - Model: AD-S42120B
  - Input: 100V to 240V AC 50/60Hz 1.2A
  - Output: 12V DC 3.5A
  - Consumption Current: Approximately 450mA
- 5. Operating Environment:**
  - Temperature: Approximately 0°C to 40°C (32°F to 104°F)
  - Humidity: 30% to 80% RH (non-condensation)
- 6. Dimensions and Weight:**
  - Dimensions: Approximately 110(W) × 104(D) × 46(H) mm  
(4<sup>5</sup>/<sub>16</sub>"W × 4<sup>1</sup>/<sub>8</sub>"D × 1<sup>13</sup>/<sub>16</sub>"H)
  - Weight: Approximately 195g (6.9oz)

The AD-S42120 series comes available in the following models depending on area or region where you are in.

Model no. of AC Adaptor	Area/Region	Compliance
AD-S42120BE AD-S42120B-N	All except China	Compliant with CE, UL, FCC, and Energy Efficiency Standards.
AD-S42120BE-CN	China only	Compliant with Energy Efficiency Standards and CCC.

# Using Rechargeable Battery Pack

---

HA-D20BAT-A

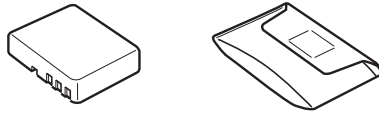

## Important!

- Store a battery pack in its special soft case whenever you are not using it.
- If the battery pack has been left over unused for a long period of time, the capacity remained decreases due to spontaneous discharge or chemical decomposition by the battery pack itself. If the battery pack fails to hold its operating duration after it has been fully charged, replace it with a new one. The battery pack may reach the end of its service life.

## Battery Pack Specifications

<b>Model:</b>	HA-D20BAT-A
<b>Rated Capacity:</b>	1850mAh (6.84 Wh)
<b>Rated Voltage:</b>	3.7V
<b>Dimensions:</b>	Approximately 52.5(W) × 40(D) × 13.5(H) mm (2 <sup>1</sup> / <sub>16</sub> "W × 1 <sup>9</sup> / <sub>16</sub> "D × <sup>9</sup> / <sub>16</sub> "H)
<b>Weight:</b>	Approximately 46g (1.6oz)
<b>Bundled Item:</b>	Soft case



# Specifications

---

## IT-300

<b>Model:</b>	IT-300-15E
<b>CPU:</b>	Marvell® PXA320 624MHz
<b>Memory:</b>	256MB RAM, 256MB Flash ROM (user defined: 120MB)
<b>OS:</b>	Microsoft® Windows® Embedded Handheld 6.5 operating system, English Version
<b>Display:</b>	9.4 cm (3.7 inches), 480 × 640-dot 2-Way TFT color LCD
<b>Laser Scanner:</b>	
Readable symbologies:	UPC-A/UPC-E/EAN8 (JAN8)/EAN13 (JAN13)/Codabar (NW-7)/Code39/Interleaved 2 of 5 (ITF)/MSI/Industrial 2 of 5/Code93/Code128 (GS1-128 (EAN128))/IATA/RSS-14 (GS1 DataBar Omnidirectional)/RSS Limited (GS1 DataBar Limited)/RSS Expanded (GS1 DataBar Expanded)/RSS-14 Stacked (GS1 DataBar Stacked)/RSS Expanded Stacked (GS1 DataBar Expanded Stacked)
Scanning distance:	Within approximately 40-400 mm (1 <sup>9/16</sup> "-15 <sup>3/4</sup> " )
<b>Bluetooth®:</b>	
Protocol:	Bluetooth® Specification Ver.2.0 + EDR
Communication Range:	Approximately 3 m (9'10 <sup>3/8</sup> " ) (depends on radio wave conditions and environment)
Output:	4dBm max. (PowerClass2)
<b>WLAN:</b>	
Standards:	IEEE 802.11b/g
Diffusion Modulation:	DS: 802.11b DS/OFDM: 802.11g
Frequency:	802.11b/g: 2.400-2.4835 GHz
Transmission Rate:	802.11b: Max. 11 Mbps 802.11g: Max. 54 Mbps
Communication Range:	50 m indoors, 150 m outdoors (varies according to usage environment and transmission rate)
<b>microSD Memory Card Slot:</b>	Compatible with SDHC Memory Card
<b>Power Requirements:</b>	
Power Source:	Battery Pack (HA-D20BAT-A)
Memory Backup:	Rechargeable Lithium Battery (Built-in)
Consumption Current:	DC 2.1A

---

**Battery Life:**

Battery pack:

Approximately 11 hours\*

Approximately 10 hours\*\*

\* under the conditions that CPU speed is set to the auto power save mode, backlight is set to off, and the ratio of cyclic operation of “Standby, Key input, and Scanning” is set at 20:1:1.

\*\* under the conditions that CPU speed is set to the auto power save mode, backlight is set to off, and the ratio of cyclic operation of “Standby, Key input, Scanning, and WLAN” is set at 20:1:1:1.

Memory backup: 10 minutes for protection of data in memory  
3 days for backup of built-in clock

**Operating Temperature:** -20°C to 50°C (-4°F to 122°F)

**Operating Humidity:** 10% to 90% RH (non-condensation)

**Dust and Water Splash Proof:**

IEC60529 standard, IP54 level

**Dimensions:** Approximately 76(W) × 155(D) × 19.6(H) mm (3"W × 6<sup>1</sup>/<sub>8</sub>"D × 3/4"H)

**Weight:** Approximately 215g (7.6oz) (when battery pack is installed)

---

## USB and Charging Unit

### Charging:

Charging Method: Constant current/voltage  
Charge Period: Approximately 4 hours (AD-S15050B)

### Power Supply:

Power Source: AC Adaptor (AD-S15050B)  
Consumption Current: 5V DC approximately 2.1A  
Output to  
Handheld Terminal: 5V DC 2.1A (max.)

### AC Adaptor

Model: AD-S15050B  
Input: 100V to 240V AC 50/60Hz 0.36 to 0.2A  
Output: 5V DC 3.0A

### Dimensions and Weight

Dimensions: Approximately 86(W) × 47(D) × 26(H) mm  
(3<sup>3</sup>/<sub>8</sub>"W × 1<sup>7</sup>/<sub>8</sub>"D × 1"H)  
Weight: Approximately 42g (1.5oz)

### Operating Environment

Temperature: 0°C to 40°C (32°F to 104°F)  
Humidity: 10% to 90% RH (non-condensation)

**CASIO®**

**CASIO COMPUTER CO., LTD.**

6-2, Hon-machi 1-chome  
Shibuya-ku, Tokyo 151-8543, Japan

## Free Manuals Download Website

<http://myh66.com>

<http://usermanuals.us>

<http://www.somanuals.com>

<http://www.4manuals.cc>

<http://www.manual-lib.com>

<http://www.404manual.com>

<http://www.luxmanual.com>

<http://aubethermostatmanual.com>

Golf course search by state

<http://golfingnear.com>

Email search by domain

<http://emailbydomain.com>

Auto manuals search

<http://auto.somanuals.com>

TV manuals search

<http://tv.somanuals.com>