

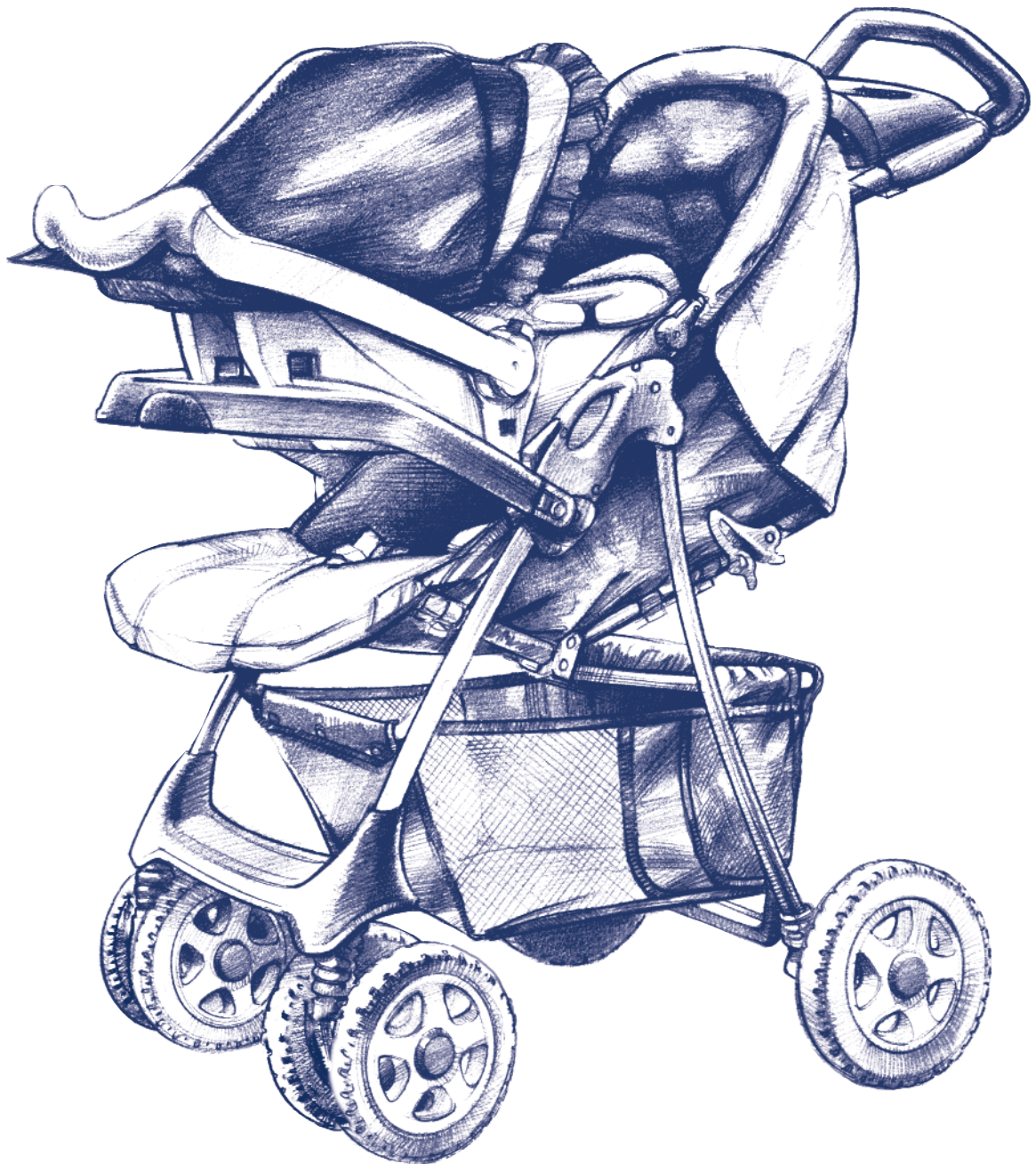

# Instruction Manual



**Do not use this product until you read and understand these instructions.**

English PM-1028AB 5/99



# IMPORTANT INFORMATION

## Table of Contents

### Page:

#### 1 Important Information

#### 2 Warnings

#### 3 Assembly

- Opening Stroller
- Front Wheel Assembly
- Locking Footrest
- Rear Wheel Assembly
- Attaching Cup Holder

#### 5 Car Seat/Stroller Use

- Locking Or Unlocking Rear Wheels
- Attaching Car Seat
- Removing Car Seat

#### 7 Stroller Use

- Locking Or Unlocking Rear Wheels
- Closing Child's Tray Slot
- Canopy Positions
- Child's Tray Use
- Seat Back Positions
- Securing Child With Harness

#### 9 Folding

#### 10 Maintenance

- Cleaning Cup Holder
- Cleaning Stroller
- Dented Wheels

#### 11 Replacement Parts

## Need Help?

If you should have any problems with this product, *call toll-free 1-800-837-4044 from anywhere in the U.S. or Canada or fax at 1-610-286-4555.*

Or write us at: Century Products  
P.O. Box 100  
Elverson, PA. 19520-9974  
Attention: Customer Service Department

Please have the following information available. See label on stroller leg.

Model Number: \_\_\_\_\_

Manufacture Date: \_\_\_\_\_

Date of Purchase: \_\_\_\_\_

## Safety First Checklist

- ✓ Read and understand stroller instruction manual before using stroller.
- ✓ Read and understand car seat instruction manual before using car seat in a vehicle.
- ✓ Use the SmartFit® Base provided with this product only with a Century Assura™, SmartFit®, SmartFit® Plus, SmartFit® Elite, SmartFit® Elite V or SmartFit® SupremeV Infant Car Seat.
- ✓ Never leave child unattended.
- ✓ Use with only one (1) child at a time.
- ✓ Do not use accessories other than those provided by Century.

**NOTE:** All warnings and instructions apply whether stroller is being used with or without child's tray in the use position.

## Weight and Height Limits

Car Seat/Stroller Use:  
Maximum Weight: 22 lbs. (10 kg)  
Maximum Height: 27 inches (69 cm)

Stroller Use:  
Maximum Weight: 40 lbs. (18.2 kg)  
Maximum Height: 40 inches (101 cm)

*Save instruction manual  
for future reference.*



## WARNINGS

**Failure to follow all warnings and instructions could result in serious injury or death.**

- **Never leave child unattended, even when sleeping.**
  - **Child may become entangled in harness straps and suffocate.**
  - **Stroller may roll away and crash even with brakes engaged.**
  
- **Avoid serious injury from falling or sliding out. Always use seat belt.**
  
- **DO NOT pull or carry stroller on stairs or escalators with child in it.**
  
- **DO NOT lift car seat/stroller unit by car seat handle or car seat shell. Handle may break.**
  
- **DO NOT allow child to climb unassisted into stroller, play, hang or pull down on car seat or stroller handle as stroller may tip over.**
  
- **DO NOT hang anything on handle or canopy. Stroller may become unstable and tip over.**
  
- **DO NOT jog with stroller. Push stroller at a normal walking speed only. Fast walking, jogging or running can cause loss of control.**
  
- **DO NOT overload basket. Maximum basket weight is 10 lbs. (4.5 kg). Stroller may become unstable and tip over.**
  
- **DO NOT use accessories other than those provided by Century.**

# ASSEMBLY

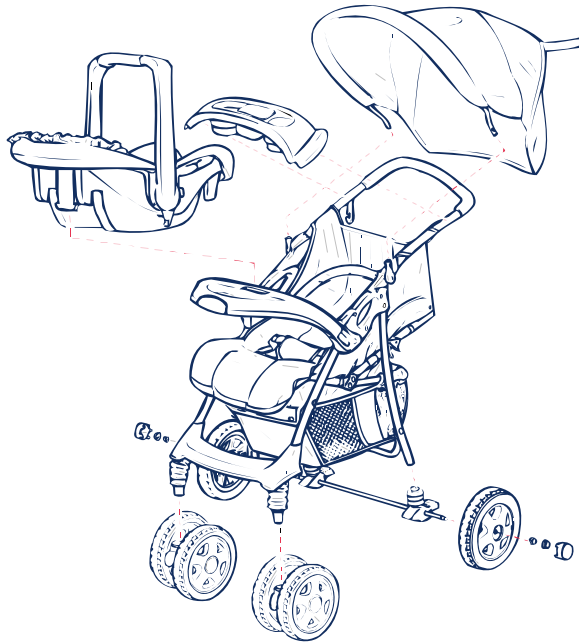

## Front Wheel Assembly

- 1 Hold swivel wheel assembly upright (*Tab* pointing down).

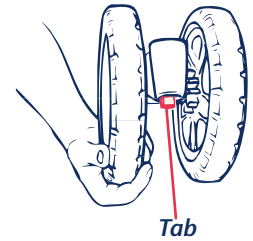

- 2 Tilt stroller slightly back and push wheel assembly onto leg until it *locks* in place.

Repeat steps 1 and 2 for opposite leg.

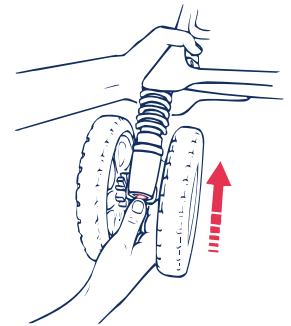

**CAUTION:** After wheel assembly is complete, pull on wheels to check that they are *locked* in place.

## Opening Stroller

- 1 Stand stroller upright and rotate lever to release latch.



- 2 Spread handle and rear legs until both *Fold Locks* "click" into position.

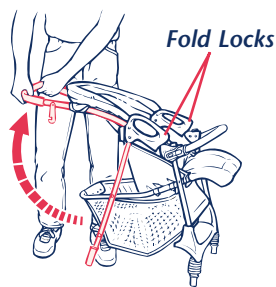

## Locking Footrest

Push footrest down so that *Cross Tube* is centered between three (3) *Tabs* on bottom of footrest, and it snaps in place.

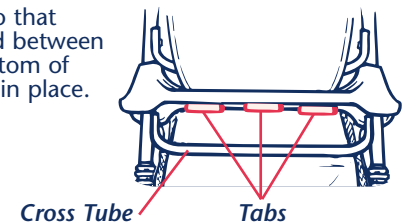

## Rear Wheel Assembly

- 1 Remove axle protectors from ends of axle and discard.

- 2 With stroller laying face down on floor, slide brake lever brackets onto rear legs until you hear a *click*.

**NOTE:** Brake levers *must* face rear of stroller.

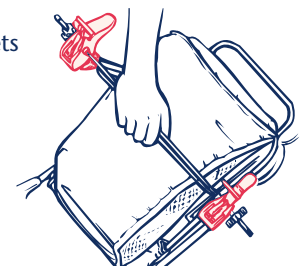

## ASSEMBLY continued

3 Secure *Wheel* to *Axle* as shown:

- Slide *Wheel* onto end of *Axle* with brake ribs facing in.
- Slide *Wheel Retainer* onto end of *Axle*. Make sure large end of *Wheel Retainer* is towards *Wheel*. *Wheel Retainer* should snap into groove on end of *Axle*.
- Snap wheel *Retainer Cap* over *Wheel Retainer*.
- Line up *Hub Cap* tabs with slots in *Wheel* and snap *Hub Cap* in place.

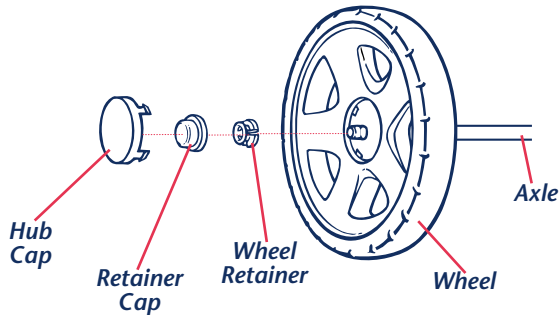

### CAUTION:

- Failure to install retainer cap may cause wheels to come off of stroller.
- After wheel assembly is complete, pull on wheels to check that they are locked into place.



## WARNING

Prevent a possible choking hazard, discard axle protectors and polybag which contained rear wheel parts.

### Attaching Cup Holder

Snap one end of cup holder over stroller frame above canopy, rotate down to opposite side and snap in place.



## WARNING

- To avoid burns, never put hot liquids in cup holder.
- Avoid possible tipping, **DO NOT** place more than 3 lbs. (1.4 kg) in cup holder.

# CAR SEAT/STROLLER USE

## Locking Or Unlocking Rear Wheels

### 1 LOCKING:

Push down on both brake levers.

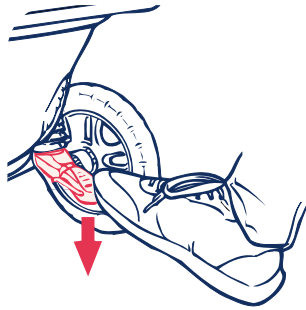

### 2 UNLOCKING:

Push up on both brake levers.

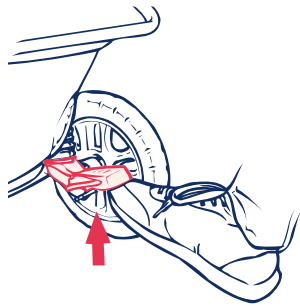

## Attaching Car Seat

### 1 Set both rear brakes to prevent stroller from moving.

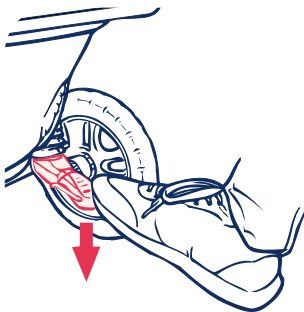

### 2 Position child's tray in up position:

- Rotate child's tray over lower edge of seat.
- Push child's tray into slots.
- Pull on child's tray to be sure it is securely **locked**.

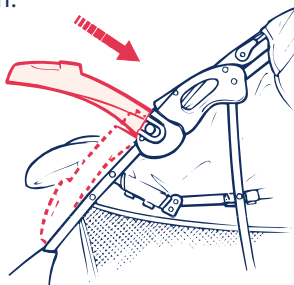

### 3 Position stroller back support in reclined position:

Squeeze both levers on sides of seat back to release.

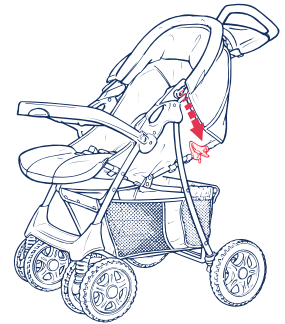

### 4 With car seat handle in **locked** carrying position (upright) insert car seat adapter **Tongue** into child's tray **Slot**.

#### NOTE:

- Before attaching car seat, be sure to remove tongue of child's tray pad by pulling out red button and pulling up on child's tray pad.
- Car seat may be placed in child's tray slot either rear-facing or forward-facing.

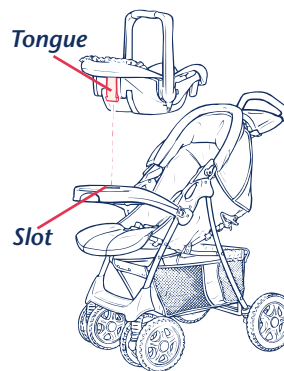

Rear-facing

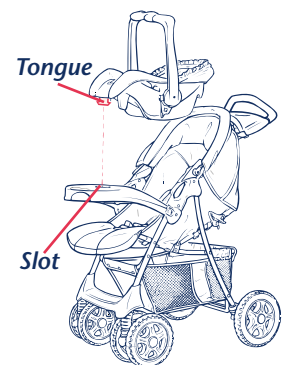

Forward-facing

### 5 Attach appropriate snaps to secure car seat to stroller:

Forward-facing Snap

Rear-facing Snap

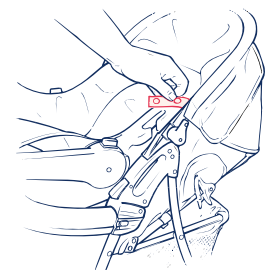
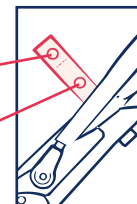

**NOTE:** Use of proper snaps provide the snugest attachment to stroller frame.

# CAR SEAT/STROLLER USE continued

- 6 Pull up on car seat to be sure it is *locked* in child's tray.

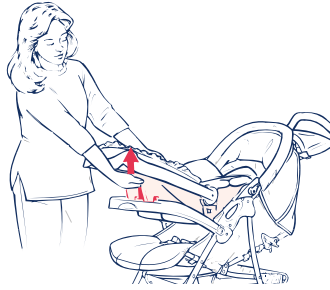

**NOTE:** Car seat comes with a level indicator which is *not* applicable when car seat is used in stroller frame.



## WARNING

**Avoid serious injury from falling or sliding out:**

- Always use waist and tummy pad to restrain child, even when sleeping.
- Always be sure car seat handle is in locked upright carrying position.
- Always make sure car seat is locked into child's tray before each use.
- Always be sure stroller is fully set up and fold locks are engaged before using.
- Always be sure brakes are locked when attaching and removing car seat from stroller frame.

## Removing Car Seat

- 1 Set both rear brakes to prevent stroller from moving.

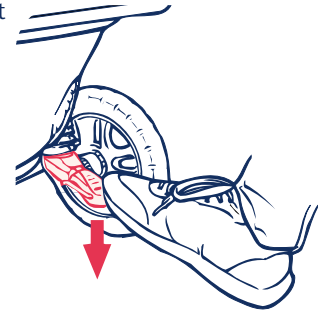

- 2 Be sure handle is locked in upright carrying position.

**DO NOT** lift car seat from child's tray until you have heard a "click" sound and have checked that handle is locked.

- 3 Pull *Red Button* on front of child's tray out and lift car seat.

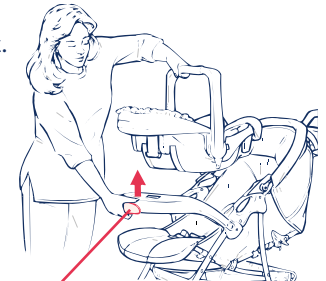

Red Button

- 4 After removing car seat, insert *Tongue* of child's tray pad into child's tray *Slot*.

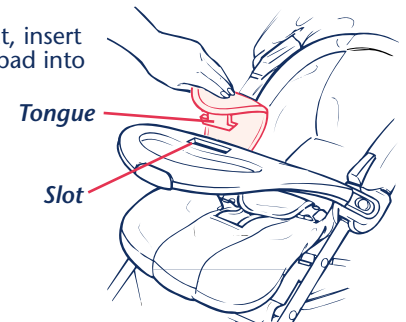

# STROLLER USE

## Locking Or Unlocking Rear Wheels

### 1 LOCKING:

Push down on both brake levers.

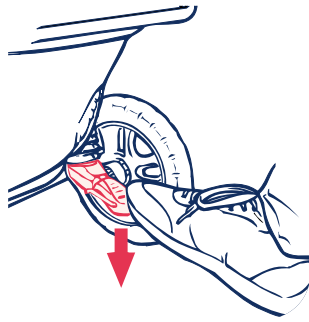

### 2 UNLOCKING:

Push up on both brake levers.

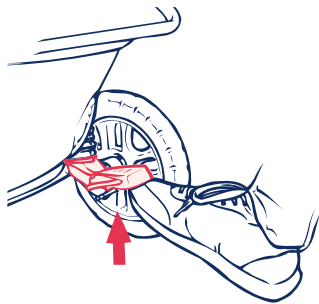

## Closing Child's Tray Slot

Insert *Tongue* of arm bar pad into child's tray *Slot*.

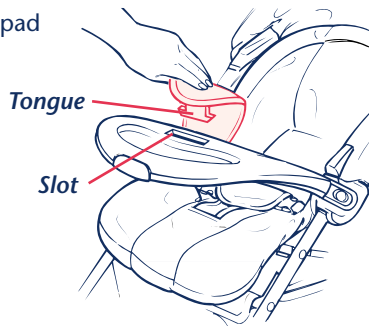

## Canopy Positions

Canopy has two (2) positions: opened and closed.

Car seat and stroller can be used together with both canopies closed.

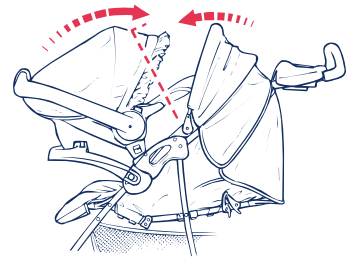

## ⚠ WARNING

Prevent serious injury:

- Make sure child is clear of any moving parts when you adjust stroller.
- DO NOT place parcels on top of canopy.

## Child's Tray Use

Stroller may be used with Arm Bar up or down.

### 1 For *up* position:

- Rotate arm bar over lower edge of seat.
- Push arm bar into slots.
- Pull on arm bar to be sure it is securely *locked*.

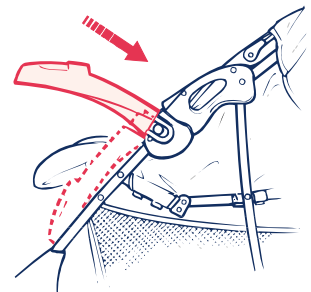

### 2 For *down* position:

- Press arm bar *Release Buttons* on *sides* of fold locks.
- Pull arm bar out until it stops.
- Allow arm bar to drop below seat.

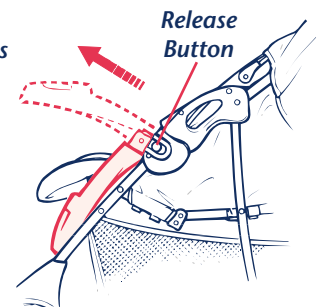



# STROLLER USE continued

## Seat Back Positions

Seat back has two (2) positions: upright and reclined.

### 1 For *upright* position:

Lift seat back forward until back support pins hook into seat back latches.

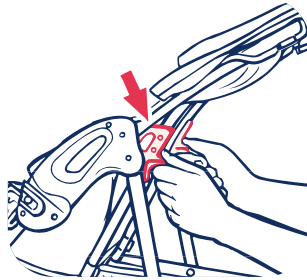

### 2 For *reclined* position:

Release both levers on sides of seat back.

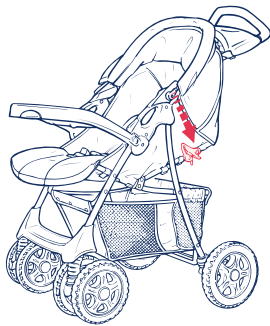

## Securing Child With Harness



## WARNING

Avoid serious injury from falling or sliding out:

- Always use waist and tummy pad to restrain child, even when sleeping.
- To prevent child from standing or sliding out of stroller, be sure waist and tummy pad are **SNUG** and do not slip loose.
- Periodically check waist and tummy pad to be sure they are snug around child.

Secure child with harness system:

- Unlock harness system by pressing **Tabs** on both buckles.

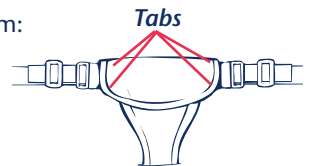

- Place waist straps around child's waist.
- Place tummy pad between child's legs.
- Snap buckle tongues into buckles on each side of tummy pad.
- Adjust waist straps to snugly fit child.



# FOLDING

## Folding Stroller

- 1 Set both rear brakes to prevent stroller from moving.

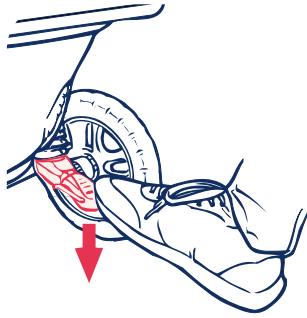

- 2 Remove car seat from stroller frame (see "To Remove Car Seat" section).

- 3 Position stroller back support in reclined position:

Release both levers on sides of seat back.

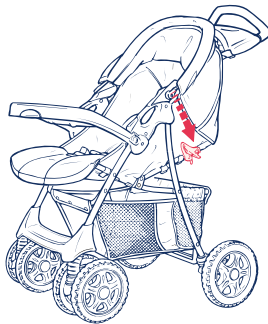

- 4 Release quick snap fold locks on each side by grasping handle grips and pressing on both buttons.

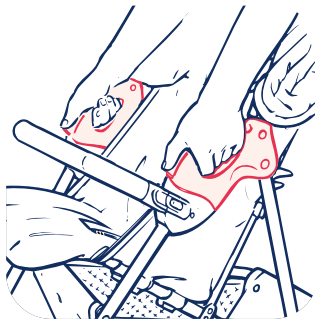

- 5 Continue holding buttons in and lift upward on handles to fold stroller.

**NOTE:** This can be done with child's tray up or down. Child's tray will drop below seat when folding.

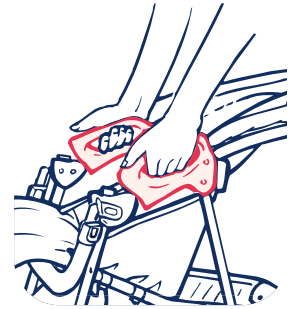

### IMPORTANT:

- When folding stroller, turn stroller front wheels to straddle frame.

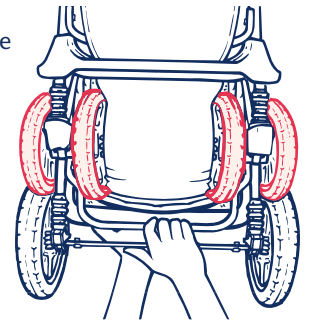

- **DO NOT** allow front wheels to rest on frame. Doing so will cause wheels to warp and they will not roll correctly.

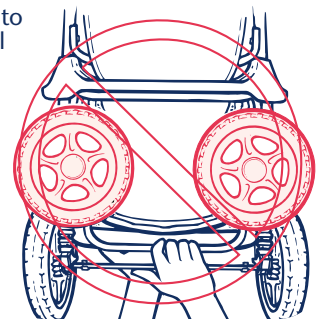

- 6 Engage latch on side of stroller to retain stroller in locked position.

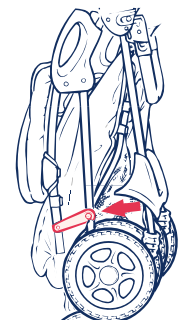

# MAINTENANCE

## Cleaning Cup Holder

To remove cup holder, pull one end up, rotate over to opposite side and pull other end up.

Wash cup holder in warm water and mild soap. **DO NOT USE** abrasives, solvents, strong detergents, or household cleaners: they can weaken plastic.

**DO NOT** place in dishwasher.

## Dented Wheels

Sometimes wheels become “*dented*” from shipment or from normal use. You may try the following procedure for repairing the dented wheel before calling our Consumer Relations Department:

Blow warm air from hair dryer over dented area for 1 to 3 minutes.

## Cleaning Stroller

### Seat and Frame:

- Wipe fabric and frame with damp cloth and mild soap. **DO NOT USE** abrasives, solvents, strong detergents, or household cleaners: they can weaken plastic.
- **DO NOT** machine wash or dry seat pads that have boards in them.

### Comfort Pad:

- Comfort pad is removable and machine washable. Machine wash in cold water, machine dry on cool setting to prevent shrinkage. **DO NOT** wash with other clothes.
- When replacing comfort pad, make sure all waist and tummy pad are rethreaded through slots in comfort pad.
- Loop front of comfort pad over leg rest and refasten attachment strips.

### Child's Tray Slot:

- Clean child's tray slot with mild soap and water. **DO NOT** use household detergents.



## WARNING

**Avoid serious injury or death.**

- **Periodically check anchoring straps beneath seat pad to ensure they are secured to frame.**
- **Periodically check and clean child's tray slot. If dirty, car seat adapter tongue will not latch properly. Remove loose objects, crumbs and any other debris from slot.**

# REPLACEMENT PARTS

Parts List	Price	Quantity	Total
<b>A.</b> Front Wheel Assembly (11-94X)	US \$ 11.00	x _____ = \$ _____	
			
<b>B.</b> Rear Wheel Kit Including Retainer and Cap (11-94X)	US \$ 5.00	x _____ = \$ _____	
			
<b>C.</b> Hub Cap Set (2) (11-94X)	US \$ 1.00	x _____ = \$ _____	
			
<b>D.</b> Seat Pad (11-94X)	US \$ 16.00	x _____ = \$ _____	
			
<b>E.</b> Comfort Pad (11-94X)	US \$ 9.50	x _____ = \$ _____	
			
<b>F.</b> Canopy Pad with Window (11-94X)	US \$ 8.00	x _____ = \$ _____	
			
<b>G.</b> Canopy Frame (11-94X)	US \$ 2.00	x _____ = \$ _____	
			
<b>H.</b> Cup Holder (11-94X)	US \$ 5.00	x _____ = \$ _____	
			
<b>I.</b> Basket (11-94X)	US \$ 7.00	x _____ = \$ _____	
			
<b>J.</b> Instruction Manual (11-94X)	FREE	x _____ = <u>FREE</u>	
			
		Total Parts	\$ _____

**11 NOTE:** Prices subject to change.

# REPLACEMENT PARTS ORDER FORM

Total Parts \$ \_\_\_\_\_  
Sales Tax \$ \_\_\_\_\_  
Shipping & Handling \$ \_\_\_\_\_  
Outside Continental USA \$ \_\_\_\_\_  
Total \$ \_\_\_\_\_

## Sales Tax

- **California, Indiana, Maryland and New York** Residents Add Sales & Applicable Local Taxes
- **Ohio** Residents Add 5.75% Sales Tax
- **Pennsylvania** Residents Add 6% Sales Tax except for **Philadelphia** and **Allegheny Counties** add 7% Sales Tax
- **South Carolina** Residents Add 5% Sales Tax

## Shipping & Handling

\$ 0.01 to \$ 5.00 = \$ 4.00  
\$ 5.01 to \$ 50.00 = \$ 5.00  
\$ 50.01 to \$200.00 = 10% of Order Total  
\$200.01 and over = 5% of Order Total

## Outside Continental USA

\$ 2.00 = AK, HI, PR, VI, Guam  
\$10.00 = Mexico  
All others, call for quote.

*We must have this information to process your order: see label on leg of stroller.*

Model No.: \_\_\_\_\_

Manufacture Date: \_\_\_\_\_

Please make checks payable in U.S. Currency to:  
**CENTURY PRODUCTS**

Or charge to **VISA** or **MASTERCARD** :

**NOTE:** If requested color is not available, a similar color will be substituted.

Cardholder's Name: \_\_\_\_\_

Card Number: \_\_\_\_\_

Card Exp. Date: \_\_\_\_\_

Check enclosed for \$ \_\_\_\_\_

## SHIP TO:

Name: \_\_\_\_\_

Address: \_\_\_\_\_

City: \_\_\_\_\_

State: \_\_\_\_\_ Zip: \_\_\_\_\_

Telephone No.:(\_\_\_\_\_) \_\_\_\_\_

**MAIL BOTH PAGES OF ORDER TO:**

**CENTURY PRODUCTS  
P.O. BOX 100  
ELVERSON, PA. 19520-9974  
ATTENTION: CUSTOMER SERVICE DEPARTMENT**

**FAX BOTH PAGES OF ORDER TO:**

**(610) 286-4555**

PM-1028AB

5/99





# Remember

**We are here to help you!**

**For immediate help, call our Customer Service  
Department at 1-800-837-4044  
from anywhere in the U.S. or Canada  
or fax at 1-610-286-4555.**



Visit us at our Web site:  
[www.centuryproducts.com](http://www.centuryproducts.com)



# SmartFIT<sup>®</sup>*series*

## **Instruction Manual**



**Para instrucciones en Español,  
llamar al: 1-800-837-4044**

**Avoid injury or death -  
Read and understand this manual!**

**Use rear-facing only!**

Download from [Www.Somanuals.com](http://www.Somanuals.com). All Manuals Search And Download.

# TABLE OF CONTENTS

---

This instruction manual is for the SmartFit®; SmartFit® Classic; SmartFit® Plus; SmartFit® PlusV; SmartFit® Elite and SmartFit® Elite V Infant Car Seats. Instructions for all models *are the same* unless otherwise noted.

## Before You Begin

Important Information.....	<b>1</b>
Warnings.....	<b>2</b>
Basic Information.....	<b>4</b>

## Use

Height & Weight Limits.....	<b>5</b>
Installation <b>With</b> Base.....	<b>6</b>
Installation <b>Without</b> Base.....	<b>7</b>
Placing Child in Car Seat.....	<b>8</b>
Operations and Adjustments.....	<b>10</b>
• Harness Tie	
• Adjustable Handle	
• Buckle System	
• Removing Car Seat from Base	
• Adjustable Base	
• Changing Harness Strap Slots	
• Changing Crotch Strap Positions	

## Special Information

Vehicle Seat Belts.....	<b>14</b>
Shopping Cart Use.....	<b>20</b>
Additional Information.....	<b>21</b>

# IMPORTANT INFORMATION

*No car seat can guarantee protection from injury in every situation, but proper use helps reduce the risk of serious injury or death.*

## Registration Information

Child restraints (car seats) could be recalled for safety reasons. You must register this restraint to be reached in a recall. Fill out the registration card attached to car seat and mail today or send your name, address, and the restraint's model number and manufacturing date to:

Century Products  
9600 Valley View Road  
Macedonia, Ohio 44056-2096  
or call 330-467-9671

For recall information, call the U.S Government's Auto Safety Hotline at 1-800-424-9393 (202-366-0123 in D.C. area).

## Safety First Check List

- ✓ Read and understand instruction manual and car seat labels.
- ✓ Use car seat **rear-facing** only.
- ✓ Do not use in vehicle seat with air bag.
- ✓ Secure children in back seat whenever possible.
- ✓ Never leave child unattended.
- ✓ Install car seat securely.
- ✓ Only use a SmartFit® base when using car seat with a base.
- ✓ Do not use after date shown on back of car seat.
- ✓ Do not allow anyone (babysitter, relatives, etc.) to use car seat without first understanding all instructions.

## WARNINGS

Failure to follow these instructions and car seat labels can result in child striking the vehicle's interior during a sudden stop or accident. Secure child restraint with a vehicle seat belt as shown in this manual.

Use this car seat **rear-facing** only. Serious crippling injury or death can result if infant faces front of vehicle.

Vehicle seat belt system **MUST** hold car seat securely. Not all vehicle seat belts can be used with a car seat. If vehicle seat belt does not hold car seat securely, read "Vehicle Seat Belts" section.

**DO NOT** use **rear-facing** child restraint in a vehicle seating position equipped with an air bag. Child's head and neck may be seriously injured when an inflating air bag hits back of child restraint.

Never put a car seat in a front vehicle seat unless recommended by vehicle owner's manual. National Highway Traffic Safety Administration (NHTSA) alerts vehicle owners that according to accident statistics children up to age 12 are safer in the back seat. For vehicle's with front passenger side air bags, refer to vehicle owner's manual for child restraint installation information.

If this car seat is in an accident, it must be replaced. **DO NOT use it again!** An accident can cause unseen damage and using it again could cause serious injury or death.

**DO NOT use car seat if it is damaged or missing parts. DO NOT use accessories or parts supplied by other manufacturers. Their use could alter the performance of the car seat and cause serious injury or death.**

**Car seat must be properly leveled:**

- **Too reclined can result in injury or ejection.**
- **Too upright can result in breathing difficulties.**

**Never leave infant unattended , even when sleeping. Infant may become tangled in harness straps and suffocate.**

**Avoid serious injury due to falls:**

- **Always keep infant buckled with harness straps.**
- **Be sure handle “locks” into carrying position and harness is buckled before carrying infant. If handle is not securely locked, car seat can flip forward causing infant to fall and be seriously injured.**
- **DO NOT use car seat on countertop.**
- **Always stay within reach of infant; an infant’s wiggling may cause car seat to move and fall off table.**

# BASIC INFORMATION

---

## Certification

This car seat meets or exceeds all applicable requirements of Federal Motor Vehicle Safety Standard 213 for use in motor vehicles and aircraft.

## Car Seat Useful Life

**DO NOT** use after date shown on back of car seat due to changing requirements and normal wear and tear.

Look for:

Do not use this car seat after December

Year

## Unoccupied Car Seat

Always secure car seat with a vehicle seat belt, even when unoccupied.

An unsecured car seat can injure passengers.

## Vehicle Seat Protection

Protect vehicle seat cover. Use a car seat mat, towel or thin blanket under car seat.

## Dangerous Vehicle Seats

Do not use on rear-facing or side-facing vehicle seats.

## Warm Weather

Car seat parts can get very hot in the sun or warm weather.

*To avoid burns, always check before putting child in car seat.*

# HEIGHT & WEIGHT LIMITS

---

This car seat is designed for *rear-facing* use only by an infant whose:

- Weight is less than 20 lbs. (9 kg) and;
- Height is 27 inches (69 cm) or less



## Preterm or Low Birth Weight Infants

A preterm or low birth weight infant may be at special risk in a vehicle or aircraft.

According to the American Academy of Pediatrics, these infants may suffer breathing difficulties if improperly reclined in a car seat.

Century advises that you have your physician or hospital staff evaluate your infant and recommend the proper car seat or car bed **before** you and your infant leave the hospital.

# INSTALLATION WITH BASE

- 1 Place base *rear-facing* on vehicle seat.
- 2 Thread vehicle lap belt through base belt *Tabs* and buckle belt.

**NOTE:** Vehicle shoulder belt must **NOT** be placed under belt *Tabs*.

- 3 Press down firmly on base to compress vehicle seat cushion while tightening vehicle lap belt (*fig. a*).
- 4 Pull front to back and left to right to check for secure installation (*fig. b*).

If not secure, see "Vehicle Seat Belts" section.

- 5 Put car seat in base and pull up on car seat to be sure it is locked in base.

- 6 Ball **MUST** be in green zone (*fig. c*). If necessary adjust *Foot* (if available) or place rolled towels under base at vehicle seat crease.

**NOTE:** Vehicle **must** be on level ground and child in car seat when leveling.

- 7 Adjust handle to a position behind car seat.

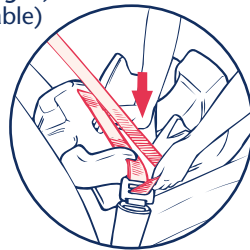
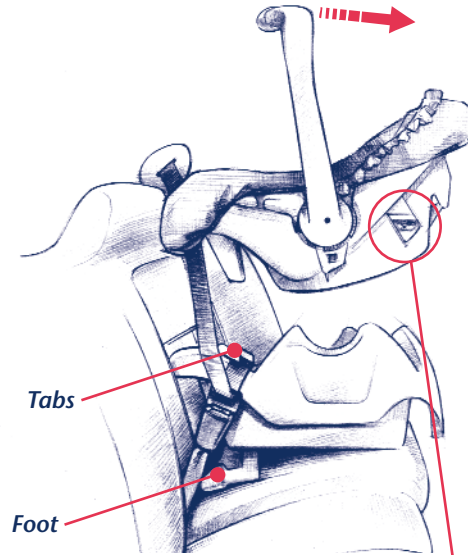

(fig. a)



(fig. b)



(fig. c)



# INSTALLATION WITHOUT BASE

- 1 Place car seat *rear-facing* on vehicle seat.
- 2 Thread vehicle lap belt through car seat *Slots* and buckle belt.  
**NOTE:** Vehicle shoulder belt must **NOT** be placed through car seat *Slots*.

- 3 Press down firmly on car seat to compress vehicle seat cushion while tightening vehicle lap belt (*fig. a*).
- 4 Pull front to back and left to right to check for secure installation (*fig. b*).

If not secure, see “Vehicle Seat Belts” section.

- 5 Ball **MUST** be in green zone (*fig. c*). If necessary place rolled *Towels* under car seat at vehicle seat crease.

**NOTE:** Vehicle **must** be on level ground and child in car seat when leveling.

- 6 Adjust handle to a position behind car seat.

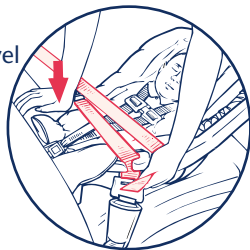
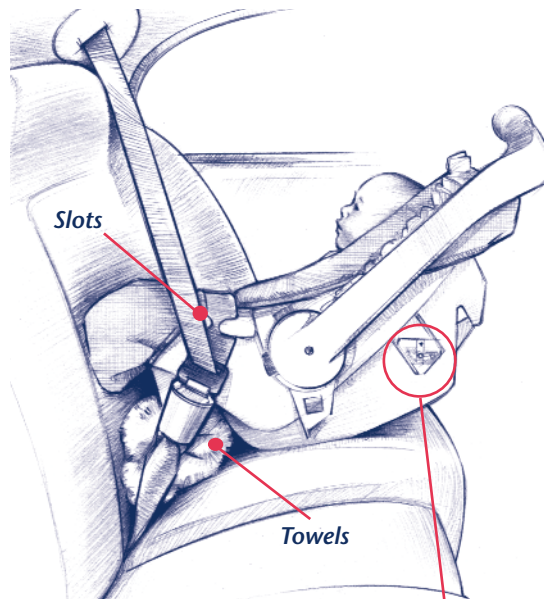

(*fig. a*)

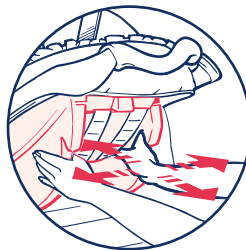

(*fig. b*)



(*fig. c*)

# PLACING CHILD IN CAR SEAT

## **WARNING**

To prevent serious injury or death:

- **Keep harness straps snug and positioned on shoulders. Periodically check adjustments.**
- **Do not use strap covers, blankets, thick cushions, or padding under harness straps or child.**
- **Baby must be dressed in clothing with arms and legs that will not interfere with buckling harness.**

Adjust harness system:

- Harness straps must be through slots *at* or *just below* shoulders.

*5-Point Models Only:*

- Crotch strap *must* be through opening closest to but not under child.

- 1** Place child in car seat with child's back flat against back of car seat.
- 2** Place harness straps over child's shoulders and lock buckle.  
  
Pull up on buckle to be sure it is locked.
- 3** Close harness tie:
  - Position harness tie at mid-chest, about 3 inches (8 cm) below child's chin.
- 4** Check that harness straps are snug with just enough room to insert one finger between child's chest and harness straps (*fig. a*).  
  
For 5-Point models, check that harness straps on chest and *thigh* are snug.
- 5** A rolled towel can be used on each side to support small children (*fig. b*). Be sure towels do not interfere with harness system.

**3-Point  
Models**

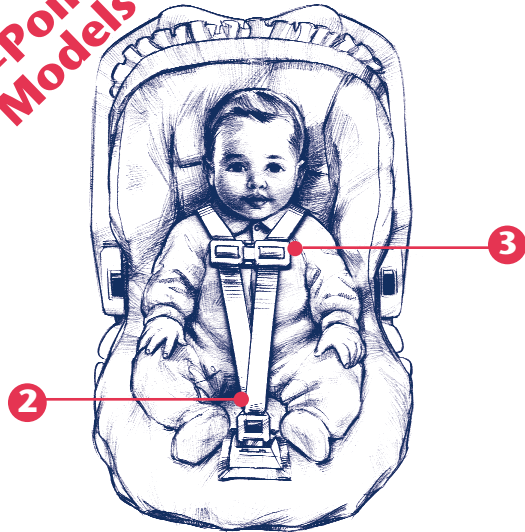

**5-Point  
Models**

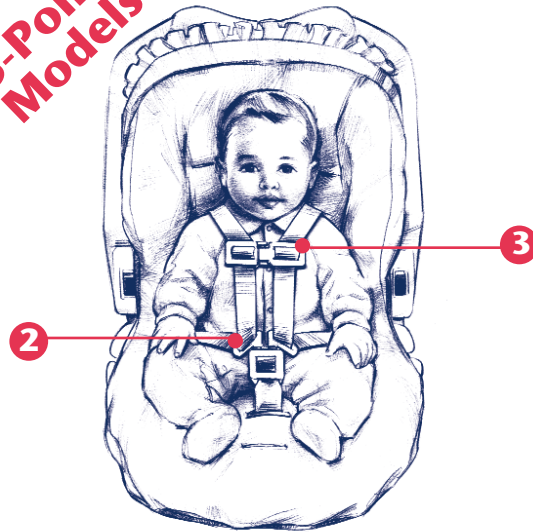

*(fig. a)*

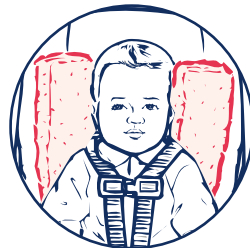

*(fig. b)*

# OPERATIONS and ADJUSTMENTS

---

## 1 **Harness Tie:**

### 2-Piece (available on some models):

- To open: Squeeze tabs and pull apart.
- To close: Snap halves together. Make sure harness tie is locked by pulling out on each half.

### 1-Piece:

- To open: Unhook harness tie from child's left side (*fig. a*) of harness strap.
- To close: From backside of harness tie, slide harness strap over harness tie tongue.

## 2 **Adjustable Handle:**

- Handle has four adjustment positions.
- Push in red buttons on each side of handle, rotate and release red buttons. Continue rotating handle to desired position until you hear a "click" sound.
- **IMPORTANT:** Before lifting car seat, place handle in "locked" upright carrying position.

## 3 **Buckle:**

### 3-Point Models

- To buckle: Push buckle down on tongue. Pull up on buckle to be sure it is locked.
- To unbuckle: Press red button and pull buckle off tongue.

### 5-Point Models

- To buckle: Insert both tongues into buckle. Pull up on tongues to be sure they are locked.
- To unbuckle: Press red button and pull harness tongues out of buckle.

## 4 **Removing Car Seat from Base:**

- Place handle in "locked" upright carrying position.
- Squeeze red release lever in base (*fig. b*).
- Lift car seat out of base.

## 5 **Adjustable Base (available on some models):**

- Pull blue adjustment *Handle* out (*fig. c*).
- Adjust *Foot* to desired position.
- Release adjustment handle. Be sure it retracts into slot.

# 3-Point Models

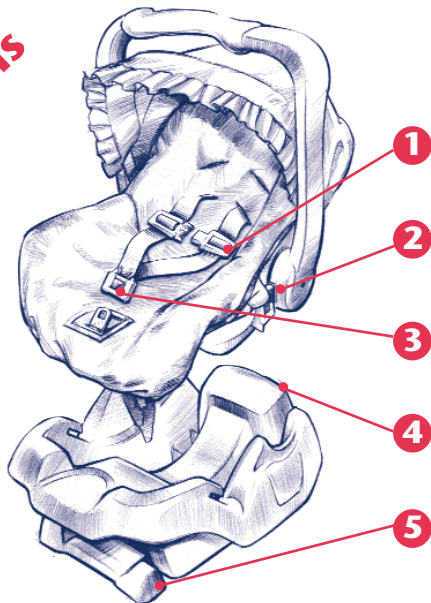

# 5-Point Models

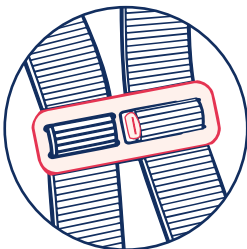
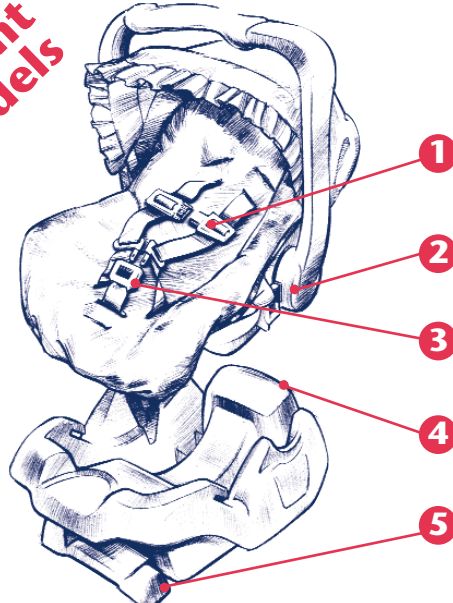

(fig. a)

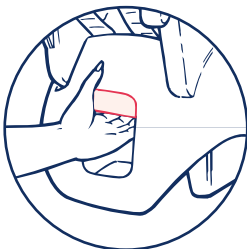

(fig. b)

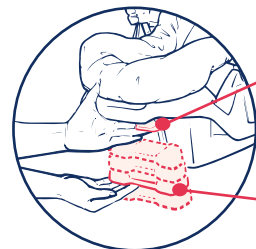

(fig. c)

# OPERATIONS and ADJUSTMENTS continued

---

## 6 Changing Harness Strap Slots (fig. d):

Harness straps must be through slots *at* or *just below* shoulders.

- Press **Tab** to release metal **Rod** and lift **Rod** out of side **Pockets**.
- Slide metal **Rod** out of **Loops** of harness straps.
- Pull harness strap out of current **Slots** and thread through desired **Slots**.

**IMPORTANT:** Straps **MUST** be through **matching Slots** of seat pad and car seat.

- Adjust strap length by inserting metal **Rod** into any **Loop** that will provide proper snugness.
- Replace metal **Rod** into side **Pockets** and slide **Rod** down below **Tab**.

**Make sure Tab holds metal Rod securely.**

## 7 Changing Crotch Strap Positions (fig. e):

**5-Point Models Only**

- From bottom of car seat, remove crotch strap **Clip**.
- From top of car seat, rethread crotch strap through desired **Opening**.
- Re-attach crotch strap **Clip exactly** as shown.

**Pull on buckle to make sure it is held securely.**

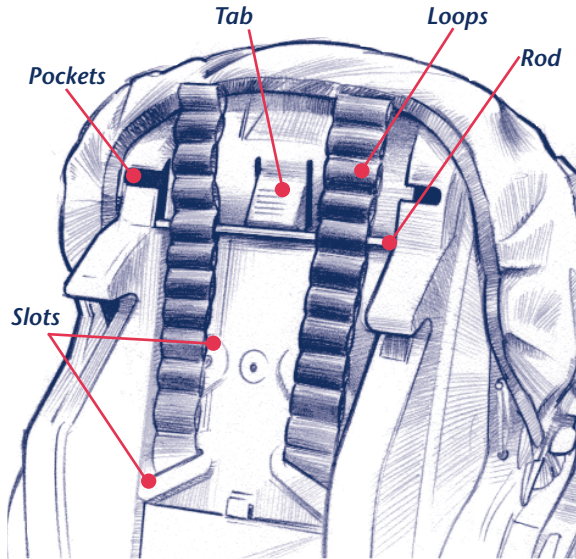

(fig. d)

**5-Point Models**

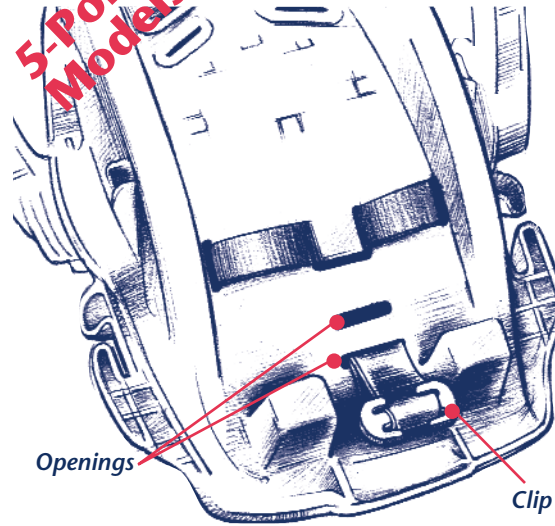

(fig. e)

# VEHICLE SEAT BELTS

---



## WARNING

**Not all vehicle seat belts can be used with a car seat. The car seat must be held securely at all times by a lap belt (or lap belt portion of a lap/shoulder belt) that will not change length while driving.**

To provide the most secure installation of the car seat:

- Read the vehicle owner's manual regarding car seat installation and seat belt use with car seat.
- Follow all instruction labels on vehicle seat belt and car seat.

If car seat is not held securely after following instructions in this manual, vehicle seat belt labels, and vehicle owner's manual:

- Move car seat to another seating location and try again, or
- Contact vehicle dealer for possible seat belt modification parts.



## Belts Forward of Seat Crease

Vehicle seat belts located forward of seat crease may not securely hold car seat. Check vehicle owner's manual or see vehicle dealer for car seat installation requirements.

- *If approved for use with car seat, install car seat and check for secure installation by pulling car seat front to back. If car seat slides forward, DO NOT use these seat belts.*

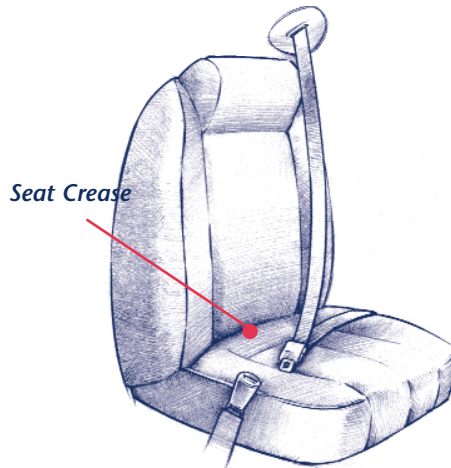
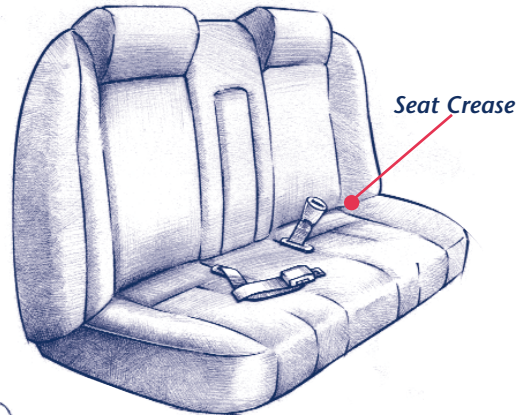

# VEHICLE SEAT BELTS continued

## ✿ Lap Belts - Manually Adjustable

The locking latch plate on some seat belts may slip and loosen after being buckled on car seat if positioned at a certain angle. If this happens, flip latch plate over (*fig. a*) and re-buckle. Test installation again to see if this works. If not, move car seat to another seating position.

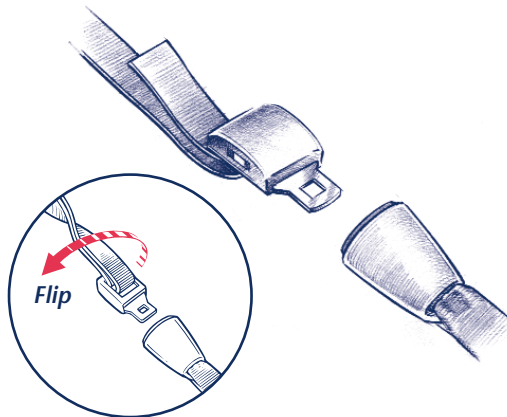

(fig. a)

## ✿ Lap Belts - With Retractor

Lap belts with retractors may or may not hold a car seat securely.

Follow these steps to determine if you have a retractor system that will hold car seat securely:

- Pull belt all the way out.
- Allow belt to retract about 6 inches (15 cm).
- Pull out on belt again.

If belt is locked and you **cannot** pull the belt out any further, you have an Auto Locking Retractor which may be used with a car seat. Remember, when installing a car seat, pull belt all the way out, buckle belt, and then tighten.

If you **can** pull the belt out again (step c), you have an Emergency Locking Retractor which **must not** be used with a car seat.

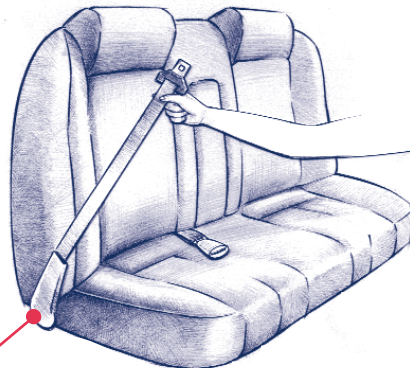

---

 **Passive Restraint - Lap Belt with Motorized Shoulder Belt**

*DO NOT* use with any car seat.

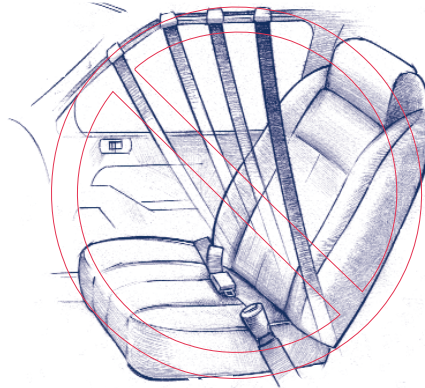

 **Passive Restraint - Lap or Shoulder Belt Mounted on Door**

*DO NOT* use with any car seat. Belts will not stay tight while driving.

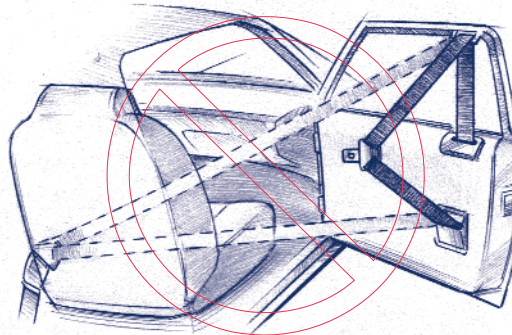

# VEHICLE SEAT BELTS continued

## ✿ Combination Lap/Shoulder Belt with Sliding Latch Plate

Pull on latch plate (*fig. a*). If belt slides freely through latch plate, a locking clip **MUST** be used (see Locking Clip section).

Some combination lap/shoulder belts with sliding latch plates may be converted into an **"automatic locking mode"** that will allow use without a locking clip. See vehicle owner's manual and label on vehicle belts for instructions.

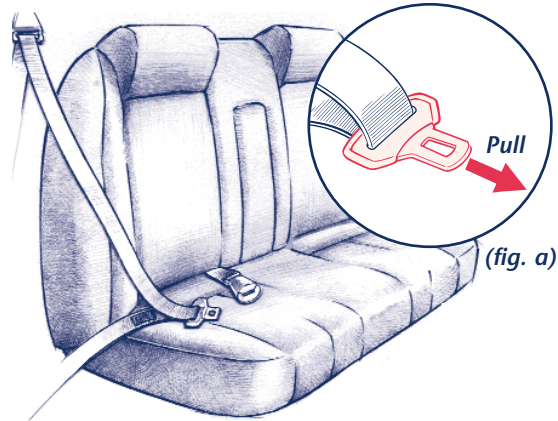

## ✿ Combination Lap/Shoulder Belt with Locking Latch Plate

The locking latch plate on some seat belts may slip and loosen after being buckled on car seat if positioned at a certain angle. If this happens, flip the latch plate over (*fig. b*) and re-buckle. Test installation again to see if this works. If not, move car seat to another seating position.

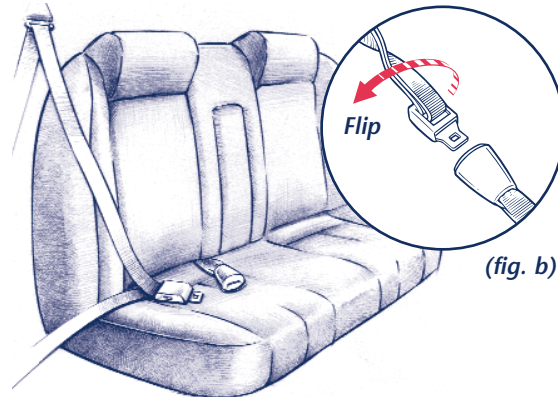

## Locking Clip

### **WARNING**

**Avoid serious injury or death:**

- **Failure to use locking clip where required will result in car seat not being securely held in place.**
- **Remove locking clip from seat belts when not being used with car seat.**

You **MUST** use locking clip provided with car seat with a vehicle seat belt that slides freely through the latch plate or the lap belt cannot be tightly secured.

- 1** Install car seat and tighten vehicle seat belt.
- 2** Hold seat belts together at latch plate (*fig. a*) then unbuckle.
- 3** Slide locking clip on seat belts approximately 1/2 inch (1 cm) away from latch plate.

**4** Re-buckle seat belt.

**5** Test installation to see if car seat is secure. If not secure, additional belt tightening may be required.

Remove locking clip and repeat steps 1 through 5.

*HINT:* Tighten vehicle seat belt by pressing base or car seat further down into vehicle seat cushion.



(*fig. a*)

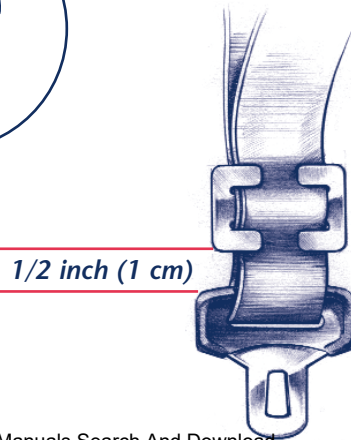

# SHOPPING CART USE

## **WARNING**

Prevent injuries from falls:

- **Make sure car seat locks onto cart.**
- **Avoid tip over of cart. Use caution on turns and irregular and ramped surface.**
- **Never leave child unattended.**

Car seat may not fit all shopping carts.  
**DO NOT** use if it will not lock onto cart.

### *Deep Basket Shopping Cart:*

Lower car seat into child seat area of shopping cart and position hook to lock over cart wire (*fig. a*).

Press down firmly on car seat back to lock.

### *Shallow Basket Shopping Cart:*

Lower car seat into large basket area of shopping cart and position hook to lock over front cross wire (*fig. b*).

Press down firmly on car seat back to lock.

To remove car seat, press in hook on back of car seat and remove from shopping cart (*fig. c*).

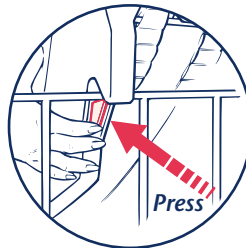
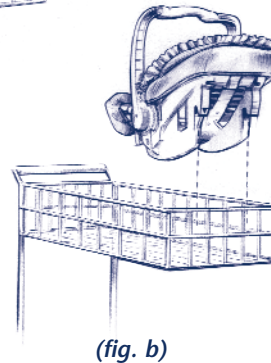
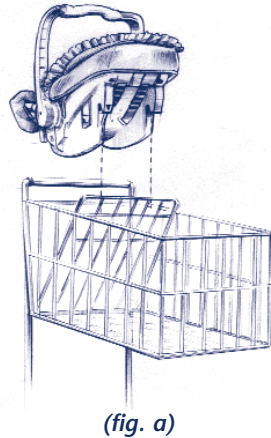

# ADDITIONAL INFORMATION

## Care & Cleaning

### *Seat Pad:*

Machine-wash separately on gentle cycle and machine-dry on cool air setting or line dry.

### *Harness Straps:*

Surface wash only with mild soap and damp cloth.

If harness straps are frayed or heavily soiled, they **MUST** be replaced.

### *Shell:*

Wipe with mild solution of soap and water. Avoid wetting labels.

Never use “household detergents”: they can weaken plastic.

### *Buckle:*

Rinse buckle with warm water. **DO NOT** use household detergents. Never lubricate buckle.

## **WARNING**

**Prevent serious injury or death:**

- **Buckle must be properly latched.**
- **Periodically inspect and clean buckle to remove objects or debris that could prevent latching.**

## Aircraft Use

This car seat is certified for use on aircraft (see label on car seat). Contact airline about their policy.

Use this car seat only on forward-facing aircraft seats.

Install car seat on an aircraft the same way it is installed in a vehicle.

## Second Hand Car Seat

Century advises against loaning or passing along car seat.



If a part is damaged, missing, or you need help or replacement parts, **DO NOT** return car seat to the store.

## CALL US FIRST

Call toll-free 1-800-837-4044 or  
330-963-2800  
8:00 AM to 6:00 PM E.S.T.  
Monday through Friday.

## or write us at:

Century Products  
9600 Valley View Road  
Macedonia, Ohio 44056-2096

Attention: Consumer Relations  
Department



Store instruction manual  
behind these tabs.

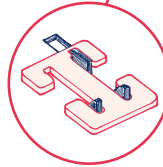
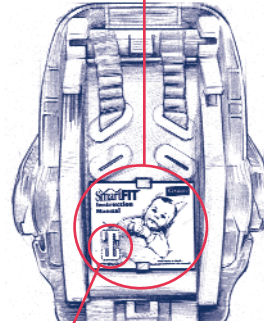

(fig. a)

Store Locking Clip  
Behind Instruction  
Manual (fig. a).  
(Location may vary  
slightly.)

For more product information  
visit us at our web site:

[www.centuryproducts.com](http://www.centuryproducts.com)



## Free Manuals Download Website

<http://myh66.com>

<http://usermanuals.us>

<http://www.somanuals.com>

<http://www.4manuals.cc>

<http://www.manual-lib.com>

<http://www.404manual.com>

<http://www.luxmanual.com>

<http://aubethermostatmanual.com>

Golf course search by state

<http://golfingnear.com>

Email search by domain

<http://emailbydomain.com>

Auto manuals search

<http://auto.somanuals.com>

TV manuals search

<http://tv.somanuals.com>