

DXG-533V and DXG-535V HD

User's Manual

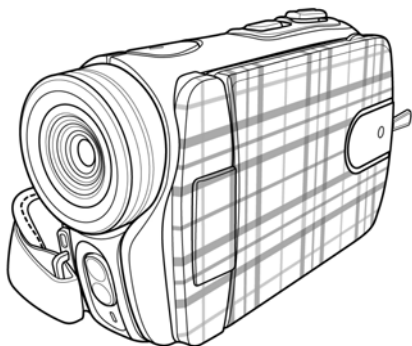

DXG USA

Table of Contents

<i>Preface</i>	v
<i>About this manual</i>	v
<i>Copyright</i>	v
<i>Precautions</i>	vi
<i>Before You Start</i>	viii
1 Introducing the camera	1
1.1 <i>System requirements</i>	1
1.2 <i>Features</i>	1
1.3 <i>Unpacking the video camera</i>	2
1.4 <i>About the camera</i>	3
1.4.1 Front view	3
1.4.2 Top view	3
1.4.3 Bottom view	4
1.4.4 Right view.....	4
1.4.5 Left view	5
1.4.6 Back view	5
1.4.7 Adjusting the LCD display.....	6
1.4.8 About the LEDs.....	10
2 Getting started	11
2.1 <i>Inserting an SD card</i>	11
2.2 <i>Inserting the batteries</i>	13
2.3 <i>Turning on the video camera</i>	14
2.4 <i>Changing modes</i>	14

2.5	<i>Before you start</i>	15
2.5.1	Setting the date and time	15
2.5.2	Setting the language	16
2.5.3	Setting the beep	17
2.6	<i>Shoot/Playback video</i>	18
2.6.1	Shooting a video clip	18
2.6.2	Playing the video clip	20
2.7	<i>Taking/viewing pictures</i>	21
2.7.1	Taking a still picture	21
2.7.2	Viewing images.....	22
2.8	<i>Connecting to a computer</i>	23
2.9	<i>Connecting to a standard TV</i>	23
2.10	<i>Connecting to a DVD Player</i>	24
2.11	<i>Connecting to an HDTV</i>	24
3	Using the camera	25
3.1	<i>Movie and voice recorder mode</i>	25
3.1.1	Movie and voice recorder mode	25
3.1.2	Using the macro function	27
3.1.3	Using the zoom function.....	27
3.1.4	Using the LED light	27
3.1.5	Quick access controls	28
3.2	<i>Photo mode</i>	29
3.2.1	Photo mode icons.....	29
3.2.2	Using the macro function	30
3.2.3	Using the zoom function.....	30

3.2.4	Using the LED light	30
3.2.5	Quick access controls	30
3.3	<i>Movie Playback mode</i>	31
3.3.1	Movie Playback mode icons.....	31
3.4	<i>Photo Playback mode</i>	34
3.4.1	Photo Playback mode icons.....	34
3.5	<i>Thumbnail mode</i>	36
3.6	<i>USB mode</i>	36
4	Using the menus	37
4.1	<i>Movie menu</i>	37
4.1.1.	White balance	37
4.1.2.	Video resolution.....	38
4.1.3.	Color effect	39
4.1.4.	Night mode.....	40
4.1.5.	Stabilizer	41
4.1.6.	Capture mode.....	42
4.2	<i>Movie playback menu</i>	43
4.2.1	Delete.....	43
4.2.2	Protect	45
4.2.3	Autoplay	46
4.3	<i>Photo menu</i>	47
4.3.1	White balance	47
4.3.2	Resolution.....	48
4.3.3	Color effect	49
4.3.4	Night mode.....	50

4.3.5	Self timer	51
4.4	<i>Photo playback menu</i>	52
4.4.1	Delete.....	52
4.4.2	Protect	54
4.4.3	Slide show	55
4.4.4	DPOF	56
4.5	<i>System menu</i>	57
4.5.1	Setting the beep.....	57
4.5.2	Histogram Mode.....	57
4.5.3	Auto power off.....	58
4.5.4	TV standard	59
4.5.5	Format	60
4.5.6	Default.....	61
4.5.7	Language	61
4.5.8	Frequency	62
4.5.9	Date/time	62
5	Installing the software	63
5.1	<i>Presto! Video Works</i>	63
5.2	<i>Presto! Mr. Photo</i>	64
5.3	<i>Quick Time</i>	65
Appendix		66
	<i>Specifications</i>	66
	<i>Troubleshooting</i>	69

Preface

Congratulations on your purchase of this advanced video camera. Make that you read this manual carefully and keep it in a safe place for future reference.

About this manual

Every effort has been made to ensure that the contents of this manual are correct and up to date. However, no guarantee is made regarding the accuracy of the contents. If the contents of this manual do not tally with the camera, please take the camera as a criterion. We reserve the right to change the contents of this manual and specifications of the product without prior notice.

If the accessories do not tally with the actual package, please take the actual package as the criterion.

Copyright

© Copyright 2009.

All rights reserved. No part of this publication may be reproduced, transmitted, transcribed, stored in a retrieval system or translated into any language or computer language, in any form or by any means, electronic, mechanical, magnetic, optical, manual or otherwise, without the prior written permission of the manufacturer.

Precautions

General precautions

- Do not use or store the product in dusty, dirty, or sandy areas, as its components may be damaged.
- Do not store the product in a hot environment. High temperatures can shorten the life of electronic devices, damage batteries and warp or melt certain plastics.
- Do not store the product in cold areas. When the product warms up to its normal temperature, moisture can form inside, and may damage the electronic circuits.
- Do not attempt to open the casing or attempt your own repairs. High-voltage internal components create the risk of electric shock when exposed.
- Do not drop or knock the product. Rough handling may damage the internal components.
- Do not use harsh chemicals, cleaning solvents or strong detergents to clean the product. Wipe the product with a slightly damp soft cloth.
- Do not fire the flash while it is too close to the subject's eyes. Intense light from the flash can cause eye damage if it is fired too close to the eyes. When using the flash, the camera should be at least one meter from the eyes of the subject.
- Do not open battery cover while an image is being recorded. Doing so will not only make storage of the current image impossible, it can also corrupt other image data already stored in file.
- If the product or any of its accessories are not working properly, take them to your nearest qualified service center. The personnel there will assist you and if necessary, arrange for the product to be repaired.

- Test for proper operation before using the camera.

Notes on the LCD Screen

Caution must be observed when dealing the fluid contained in the LCD. Ensure that fluid does not leak if the screen becomes cracked or damaged. If this occurs, follow these steps:

- If the fluids make contact with skin, wipe it with a clean cloth then rinse with a large amount of water.
- If the fluid makes contact with eyes, wash eyes with clean water for at least 15 minutes and seek immediate medical attention.
- If the fluid is swallowed, first rinse mouth with water, then drink a large amount of water and induce vomiting. Seek immediately medical attention

Operation conditions

- This camera is designed for use in temperatures ranging from 0°C to 40°C (32°F to 104°F).
- Do not use or keep the camera in the following areas:
 - In areas subject to direct sunlight
 - In areas subject to high humidity or dust
 - Near air conditioners, heaters, or other areas subject to temperature extremes
 - Inside of a closed vehicle, especially one parked in the sun.
 - In areas subject to strong vibration

Power supply

- Use only the type of battery that came with your camera. Using any other type of battery may damage the equipment and invalidate the warranty.

- Ensure the battery is inserted correctly. Inserting the battery incorrectly can cause damage to the product and possibly start a fire.
- Remove the battery to avoid the fluid leakage if the camera is not going to be used for a long time.
- If the battery is crushed or damaged, remove it immediately to avoid the battery fluid leakage and abnormal expansion.
- The camera can be used with either a Li-ion or four AAA size batteries. Li-ion battery is recommended to use for longer operation time.

Before You Start

Take some test shots before performing a formal recording.

Before taking pictures with this DV camera in any important occasion (such as a wedding ceremony or an overseas trip), do test the DV camera beforehand to ensure that it functions properly. Any additional loss caused by the malfunction of this product (such as costs of photography or any loss of benefit generated by the photography) is not the responsibility of the manufacturer and no compensation will be given for it.

Copyright information

Take care to observe "No Photography" notices in certain locations. In these cases, you cannot record any live performance, improvisation or exhibits, even for personal purposes. Any transfer of pictures or memory card data must be conducted under the constraints of copyright law.

1 Introducing the camera

Read this section to learn about the features and functions of the video camera. This chapter also covers system requirements, package contents, and descriptions of the hardware components.

1.1 System requirements

The video camera requires a PC with the following specifications:

- Windows® Vista / XP operating system
- Intel® Pentium 4 2.8 GHz CPU or higher
- At least 512 MB of RAM or higher
- Standard USB 1.1 port or higher
- At least 64MB or greater video card

- **Note:** A USB 1.1 port will enable you to transfer files to and from your host PC, but transfer speeds will be much faster with a USB 2.0 port.

1.2 Features

The video camera offers a variety of features and functions including:

- HD Digital camcorder
- Digital camera (max. 8 Megapixels)
- HDMI audio-video output
- Voice recorder
- USB mass storage
- Max. 3X digital zoom

1.3 Unpacking the video camera

The following items should be present in the package. If any item is missing or appears damaged, contact your dealer immediately.

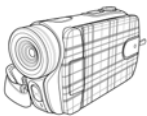

Video camera

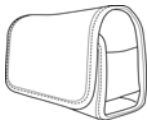

Pouch



USB & AV cable



AAA batteries x 4



User manual



**CD-ROM
(Driver and application
software)**



HDMI cable

1.4 About the camera

Refer to the following illustrations to familiarize yourself with the buttons and controls of this video camera.

1.4.1 Front view

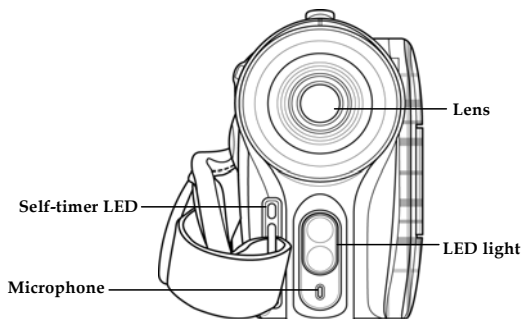

1.4.2 Top view

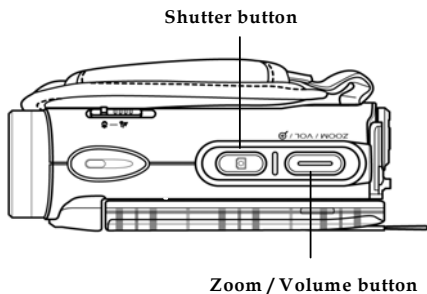

1.4.3 Bottom view

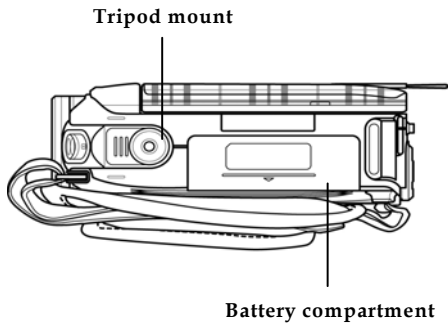

1.4.4 Right view

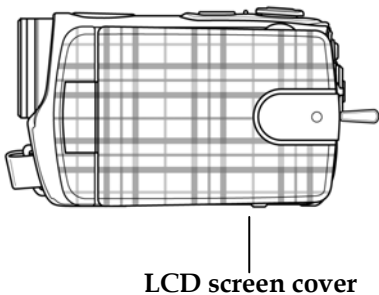

1.4.5 Left view

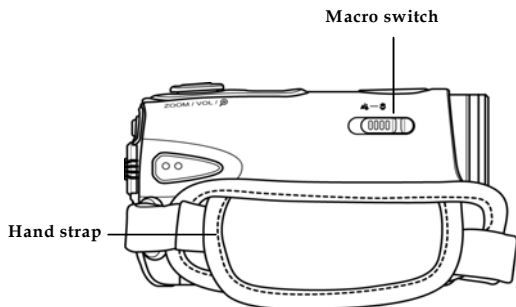

1.4.6 Back view

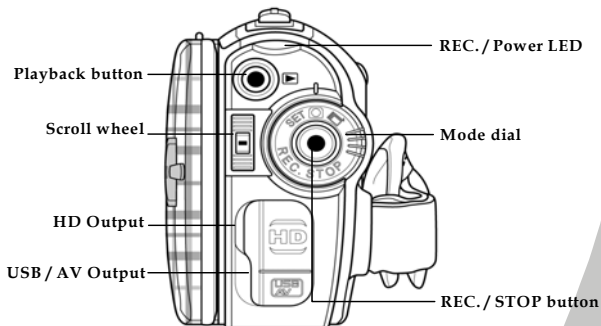





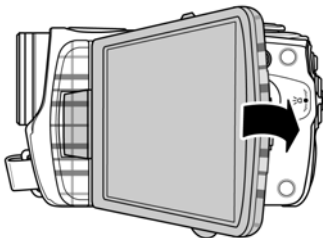
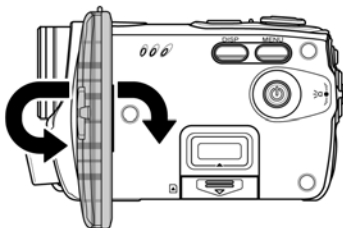
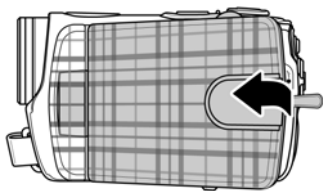



1.4.7 Adjusting the LCD display



Flip and twist the LCD screen as shown while capturing a still image or recording a video clip.



See the table below for a description of each button's function.

Button	Name	Function
	Power button	Press and hold to turn power on/off.
	Menu button	Press to display main OSD* menus.
	Mode dial	<ul style="list-style-type: none"> ● Use to toggle Movie, Photo, and SET modes. ● In Movie mode, press the REC. button to start and stop recording. ● During Movie Playback mode, press the REC. to pause/restart playing.
	Scroll wheel	<ul style="list-style-type: none"> ● In Photo and Movie modes, press up and down to increase/decrease the EV settings, and inwards to adjust the LED light setting. ● In Photo Playback mode: <ol style="list-style-type: none"> 1. Press up and down to scroll through stored images. 2. When the image is zoomed in, you can move the image up/down or left/right. Then, press inwards the scroll wheel, to switch the moving directions (up/down ↔ left/right). 3. In the thumbnail mode, press the up and down to select the

		<p>thumbnail images and then press inwards to view the image in full screen mode.</p> <ul style="list-style-type: none"> ● In Movie Playback mode: <ol style="list-style-type: none"> 1. Press up and down to scroll through stored movies, and press inwards to play/stop movie playback. 2. While playing a movie, press the scroll wheel up / down to rewind / fast forward the movie. 3. In the thumbnail mode, press the up and down to select the video clip and then press inwards to show the video clip. ● In SET mode, press up and down to highlight menu items, and inwards to select.
	Shutter button	<ul style="list-style-type: none"> ● In Photo mode, press to take a photo. ● In Movie mode, you can also press to take a photo before recording a video clip.
	Macro switch	Move the switch to the  position to enable Macro mode.
	Playback button	In Movie and Photo mode, press to enter playback mode.

	<p>Display button</p>	<p>Press once to display all OSD icons. Press again to turn all OSD icons off.</p>
	<p>Zoom button</p>	<ul style="list-style-type: none"> ● In Photo and Movie modes, press to zoom in and out. ● In Photo Playback mode: <ol style="list-style-type: none"> 1. Press the button right to zoom in your photo. 2. Press the button left to show all stored files in a 3x2 matrix thumbnail view. ● In Movie Playback mode: <ol style="list-style-type: none"> 1. Press the button left to show all stored video clips in a 3x2 matrix thumbnail view. 2. During video playback, press the button to increase or decrease the playback volume.

*OSD: On Screen Display

1.4.8 About the LEDs

The following table describes the camera LEDs:

LED	Color	Definition
Power / Rec.	Green	Power-on
	Red Blinking	Recording
	Red	Camera busy
	Red Blinking	Self-timer is activated
	Red Blinking Rapidly	2 seconds self-timer remaining.
Self-timer	Red Blinking	Self-timer is activated.
	Red Blinking Rapidly	2 seconds self-timer remaining.

2 Getting started

Read this section to learn how to start using the video camera. This section covers basic functions such as switching on, inserting the battery and memory cards, and configuring preliminary settings. See later chapters for advanced functions.

2.1 Inserting an SD card (SD card sold separately)

An SD card can be installed in the video camera to provide additional storage space for still images, video clips, or other files.

1. Open the LCD screen cover and open the SD card compartment cover.



2. Insert an SD card, making sure the contacts are facing downwards.

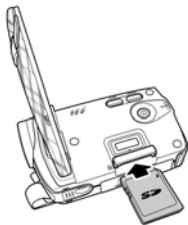

3. Press down the SD card compartment cover.



4. Push the SD card compartment cover inwards.



2.2 Inserting the batteries

This video camera is designed to use AAA alkaline batteries or a rechargeable Li-Ion battery. Only use the batteries supplied or similar batteries recommended by the manufacturer or your dealer.

- **Note:** Installing the battery incorrectly could cause damage to the camera and possibly start a fire.

1. Open the battery compartment cover.

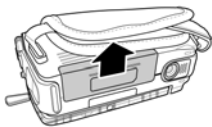

2. Insert the batteries as shown.

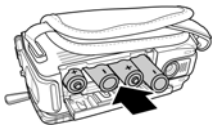

3. Close the battery compartment cover.

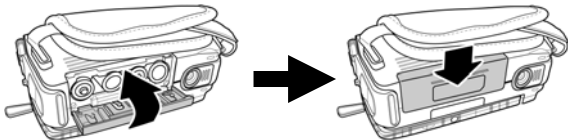

2.3 Turning on the video camera

Press and hold the power button to turn the video camera on/off.

2.4 Changing modes

The video camera can operate in three modes, **Movie**, **Photo**, and **SET**. Move the mode dial to toggle different modes.



2.5 Before you start

Before you start using the video camera, some basic settings such as date and time, languages and beep function need to be configured.

2.5.1 Setting the date and time

1. Turn on the video camera, and move the mode dial to **SET**. Move the scroll wheel up/ down to highlight **Date / Time**. Press the scroll wheel inwards to confirm.



2. Press the scroll wheel up / down to highlight each field and inwards to select a field.

Year/Month/Day
Hour/Minute/Second

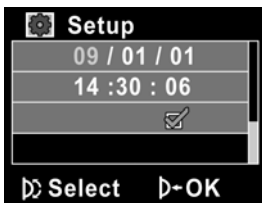

3. Adjust each value by moving the scroll wheel up and down. Press the scroll wheel inwards to save your changes.

4. Press the scroll wheel down to highlight \surd to leave the date menu.

2.5.2 Setting the language

1. Turn on the video camera, and move the mode dial to **SET**. Move the scroll wheel up /down to highlight **Language**. Press the scroll wheel inwards to confirm.

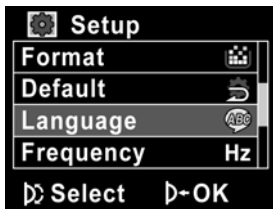

2. Use the scroll wheel to select the following languages: **English, Traditional Chinese, Simplified Chinese, German, Italian, Spanish, French, Turkish, Portuguese, Dutch, Japanese, Russian, Korean, and Arabic**. After the language is selected, press the scroll wheel inwards to confirm.

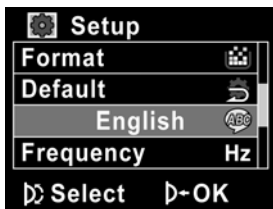

2.5.3 Setting the beep

1. Turn on the video camera, and move the mode dial to **SET**. Move the scroll wheel up/ down to highlight **Beep**. Press the scroll wheel inwards to confirm.



2. Use the scroll wheel to select and press the scroll wheel inwards to confirm.



2.6 Shoot/Playback video

2.6.1 Shooting a video clip

1. Turn on the video camera and move the mode dial to **Movie** mode.







2. Use the LCD screen to frame the video.
3. Press the **REC. / STOP** button to start recording.
4. Press the **REC. / STOP** button again to stop recording.
5. The video clip is automatically saved with a unique file name.

Notes:

1. The maximum length of each video recording file is 3.66 GB. When the maximum length is reached, the recording will automatically stop.
2. High-resolution settings result in larger files, and therefore shorter length.

3. The LCD preview and the ratio of a still-image capture can vary depending on the different video resolution settings. See the following table:

Video resolution	Preview	Taking pictures and focusing
720P	16:9 ratio 	4:3 ratio 
WVGA		
QVGA	4:3 ratio 	4:3 ratio 

4. Before shooting a video clip, you can still take a photo in **Movie** mode.

2.6.2 Playing the video clip

1. In **Movie** mode, press the **Playback** button and the most recent file displays on the LCD screen.

Movie playback
mode indicator



2. Move the scroll wheel up and down to scroll through the video clips. Press the scroll wheel inwards to play back the video clip.
3. To pause while playing back the video clip, press the **REC./STOP** inwards.
4. When viewing the video clip, press the **Zoom** button left or right to adjust the volume.
5. Press the scroll wheel inwards to stop playing.
6. Press the **Playback** button again to return to **Movie** mode.

2.7 Taking/viewing pictures

2.7.1 Taking a still picture

1. Turn on the camera and move the mode dial to **Photo** mode.

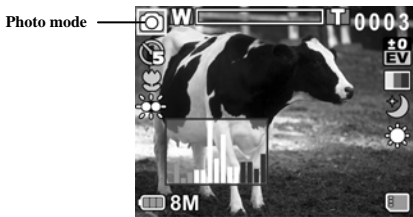

2. Use the LCD screen to frame the picture.
3. Press the **Shutter** button to capture the image.
4. The picture is automatically saved with a unique file name.

2.7.2 Viewing images

1. In **Photo** mode, press the **Playback** button and the most recent image displays on the LCD screen.

Playback mode



2. Press the scroll wheel up and down to scroll through the images.
3. Press the **Zoom** button right to zoom in the picture. Then you can move the image up/down or left/right and press inwards the scroll wheel, you can switch the moving directions (up/down ↔ left/right).
4. Press the **Zoom** button left fully zoomed out to view thumbnails of all stored files and then press the scroll wheel up and down to select the thumbnail images.
5. Press the scroll wheel inwards to view the image in full screen mode.
6. Press the **Playback** button again to return to **Photo** mode.

2.8 Connecting to a computer

Read this section to learn how to transfer files to a PC, show the video clips or photos on TV/DVD.

Connect the video camera to a computer with the USB cable provided.

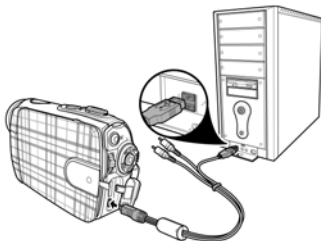

2.9 Connecting to a standard TV

Connect the video camera to a standard TV as shown with the AV cable provided.

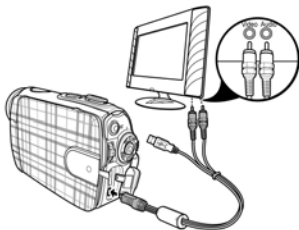

2.10 Connecting to a DVD Player

Connect the video camera to a DVD player with the AV cable provided.

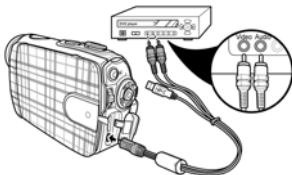

2.11 Connecting to an HDTV

Read this section to learn how to show the video clips or photos on an HDTV. Connecting to an HDTV offers the high resolution for displaying the video clips or photos.

Connect the video camera to an HDTV as shown with an HDMI cable.

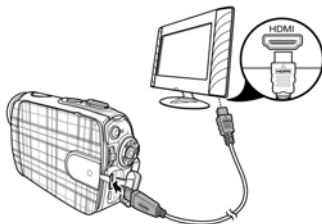

- **Note:** Photo capturing, movie recording, and voice recording are not supported when connected to an HDTV and TV.

3 Using the camera

Read this section to learn how to use the camera.

3.1 Movie and voice recorder mode

Use this mode to capture video clips or record voice and store them in an internal memory or on an SD card.

3.1.1 Movie and voice recorder mode



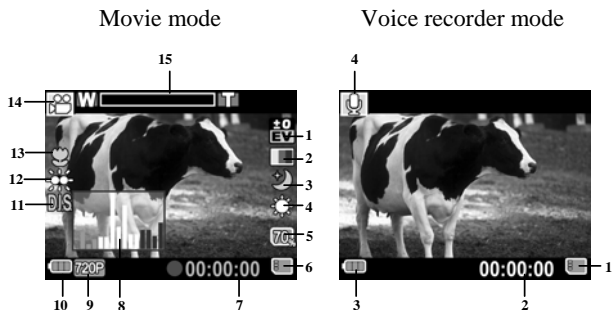











Use the following picture to familiarize yourself with the **Movie and voice recorder** mode icons and symbols.



Movie mode:





See the table below for a description of each icon and symbol.



1		EV compensation indicator
2		Effect indicator
3		Night mode indicator

4		White balance indicator
5		Remaining memory capacity
6		Memory status indicator  : SD card indicator  : Internal memory indicator
7		Remaining recording time indicator
8		Histogram indicator
9		Resolution indicator
10		Battery indicator
11		Stabilizer indicator
12		LED light indicator
13		Macro indicator
14		Movie mode indicator
15		Zoom indicator

Voice recorder mode:

See the table below for a description of each icon and symbol.

1		Memory status indicator  : SD card indicator  : Internal memory indicator
2		Remaining recording time indicator

3		Battery indicator
4		Voice recorder mode indicator

3.1.2 Using the macro function

This function can capture subjects close to the lens. In macro mode, subjects can be as close as 17-18 cm.

While in **Photo** or **Movie and voice recorder** modes, move the **Macro** switch on the side of the video camera to activate macro function, and an icon  displays on the LCD screen.

Move the macro switch again to return to normal mode.

3.1.3 Using the zoom function

The camera is equipped with 3x digital zoom.

Move the zoom button to the **right** to get closer to a subject.

Move the zoom button to the **left** to move away from a subject.

3.1.4 Using the LED light

Use the LED light to illuminate subjects in dark environments.

Press the scroll wheel inwards to choose from the following lighting options: **Off** and **On** modes. An icon displays on the screen when activated.

3.1.5 Quick access controls

You can also make adjustments to exposure and lighting settings by pressing the scroll wheel up and down or inwards.

In **Movie** and **Photo** modes, press the scroll wheel up or down to adjust the EV compensation setting. Press the scroll wheel inwards to choose lighting options.

3.2 Photo mode

Use **Photo** mode to capture still pictures and store them in the internal memory or on an SD card.

3.2.1 Photo mode icons

Use the following picture to familiarize yourself with the **Photo** mode icons and symbols.

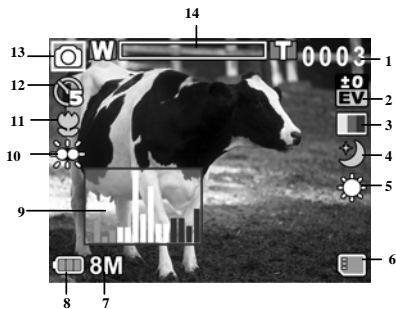

See the table below for a description of each icon and symbol.

1	0003	Remaining number of photos
2	±0 EV	EV compensation indicator
3		Effect indicator
4		Night mode indicator
5		White balance indicator

6		Memory status indicator : SD card indicator : Internal memory indicator
7		File size indicator
8		Battery indicator
9		Histogram indicator
10		LED light indicator
11		Macro indicator
12		Self timer indicator
13		Photo mode indicator
14		Zoom indicator

3.2.2 Using the macro function

See section 3.1.2 “Using the macro function”.

3.2.3 Using the zoom function

See section 3.1.3 “Using the zoom function”.

3.2.4 Using the LED light

See section 3.1.4 “Using the LED light”.

3.2.5 Quick access controls

See section 3.1.5 “Quick access controls”.

3.3 Movie Playback mode

Use **Movie Playback** mode to review all the movie files stored in the video camera.

3.3.1 Movie Playback mode icons



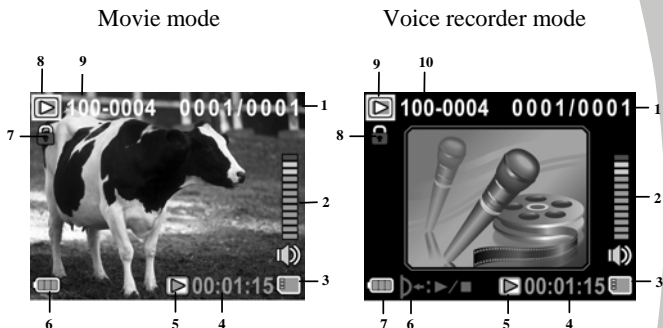



Refer to the following picture to familiarize yourself with the **Movie Playback** mode icons and symbols.



Movie mode:







See the table below for a description of each icon and symbol.



1	0001/0001	Displays the number of current movie / total number of recorded video clips
2		Volume level

3		Memory status indicator  : SD card indicator  : Internal memory indicator
4	00:00:00	The length of every video clip
5		Play/ Pause indicator
6		Battery status indicator
7		File protect indicator
8		Movie playback mode icon
9	100-0001	Displays the file number of the video clip

Voice Recorder mode:

See the table below for a description of each icon and symbol.

1	0001/0001	Displays the number of current audio/ total number of recorded audio clips
2		Volume level
3		Memory status indicator  : SD card indicator  : Internal memory indicator
4	00:00:00	The length of every audio clip
5		Play/ Pause indicator
6		Indicates: press to Play/ Stop

7		Battery status indicator
8		File protect indicator
9		Voice playback mode
10	100-0001	Displays the file number of the audio clip

3.4 Photo Playback mode



Use **Photo Playback** mode to review all the image files stored in the video camera.



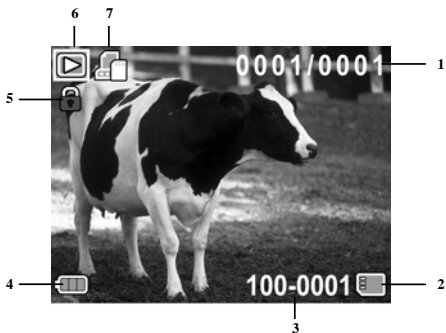

3.4.1 Photo Playback mode icons

Refer to the following picture to familiarize yourself with the **Photo Playback** mode icons and symbols.



See the table below for a description of each icon and symbol.

1	0001/0001	Displays the number of current image / the total number of saved images
2		Memory status indicator  : SD card indicator  : Internal memory indicator
3	100-0001	Displays the file number of the photo

4		Battery status indicator
5		File protect indicator
6		Playback mode icon
7		DPOF (Digital Print Order Format) indicator

3.5 Thumbnail mode

When in **Photo Playback** or **Movie Playback** modes, press the zoom button left to show images as thumbnails.

1. Turn on the video camera and make sure it is in **Photo Playback** or **Movie Playback** mode.
2. The most recent image / video clip displays on the screen. Press the zoom button left to view **six** thumbnail images / video clips on the LCD screen.



3. Press the scroll wheel up and down to highlight an image, or a video clip, and press inwards to view the image or playback the video clip or voice file in full screen mode.
4. Press the zoom button left to return to thumbnail view.

3.6 USB mode

You can use USB mode to connect to a host PC.

When connected to a host PC, the video camera is shown as a removable drive in Windows Explorer.

4 Using the menus

Read this section to learn how to configure the camera settings and use the advanced features.

4.1 Movie menu

When in **Movie** mode, press the **MENU** button to show the Movie options menu.

4.1.1. White balance

Use this option to correct color difference for different lighting conditions. When white balance is set to **Auto**, the video camera automatically compensates for different lighting conditions.

1. Turn the video camera on and ensure it is in **Movie** mode.
2. Press the **MENU** button and use the scroll wheel to highlight the **White Balance** option. Press the scroll wheel inwards to display the submenu.
3. Use the scroll wheel to select **Auto**, **Sunny**, **Cloudy**, **Tungsten**, or **Fluorescent**. Press the scroll wheel inwards to confirm.

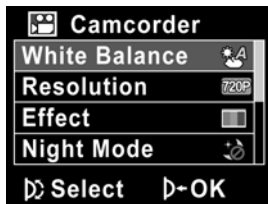

4. Press the **MENU** button again to exit the menu.

4.1.2. Video resolution

Use the resolution option to determine the resolution of the captured video. The larger screen size requires more memory storage space.

1. Turn the video camera on and ensure it is in **Movie** mode.
2. Press the **MENU** button and use the scroll wheel to highlight the **Resolution** option. Press the scroll wheel inwards to display the submenu.
3. Use the scroll wheel to select **QVGA**, **WVGA** or **720P**. Press the scroll wheel inwards to confirm.

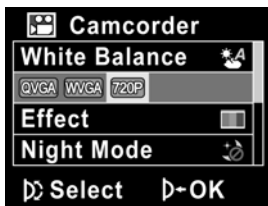
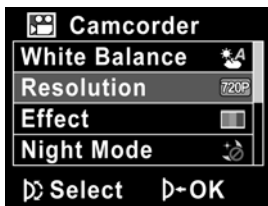

4. Press the **MENU** button again to exit the menu.

• **Notes:**

1. The LCD displays the 16:9 ratio while setting the video resolution to WVGA or 720P.
2. The LCD displays the 4:3 ratio while setting the video resolution to QVGA.

4.1.3. Color effect

The camera can capture standard color images, black and white images, or sepia tone to give an old-fashioned look.

1. Turn the video camera on and ensure it is in **Movie** mode.
2. Press the **MENU** button and use the scroll wheel to highlight the **Effect** option. Press the scroll wheel inwards to display the submenu.
3. Use the scroll wheel to select **Color**, **B&W** or **Sepia**. Press the scroll wheel inwards to confirm.

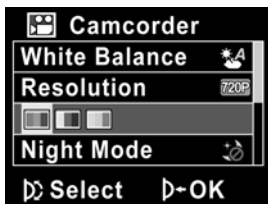
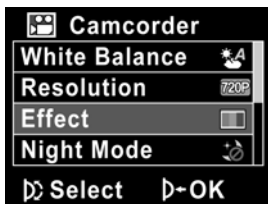

4. Press the **MENU** button again to exit the menu.

4.1.4. Night mode

Use this function to shoot a better video clip quality in dark environments.

1. Turn the video camera on and ensure it is in **Movie** mode.
2. Press the **MENU** button and use the scroll wheel to highlight the **Night Mode** option. Press the scroll wheel inwards to display the submenu.
3. Use the scroll wheel to select **Off** or **Night mode** option. Press the scroll wheel inwards to confirm.

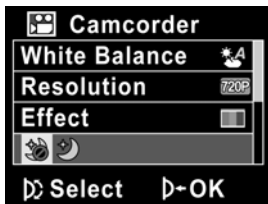
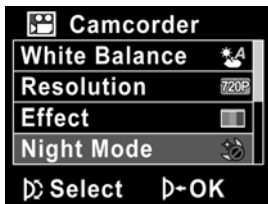

4. Press the **MENU** button again to exit the menu.

4.1.5. Stabilizer

Use this function to activate Stabilizer to prevent blurred images caused by shaking.

1. Turn the video camera on and ensure it is in **Movie** mode.
2. Press the **MENU** button and use the scroll wheel to highlight the **Stabilizer** option. Press the scroll wheel inwards to display the submenu.
3. Use the scroll wheel to select **On** or **Off**. Press the scroll wheel inwards to confirm.

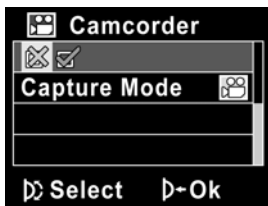
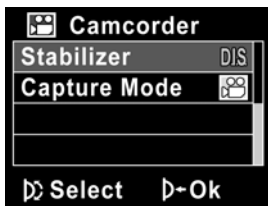

4. Press the **MENU** button again to exit the menu.

4.1.6. Capture mode

Use this function to record sound or image.

1. Turn the video camera on and ensure it is in **Movie** mode.
2. Press the **MENU** button and use the scroll wheel to highlight the **Capture Mode** option. Press the scroll wheel inwards to display the submenu.
3. Use the scroll wheel to select **Voice recorder** or **Video** options. Press the scroll wheel inwards to confirm.

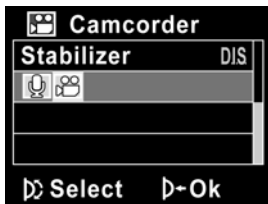
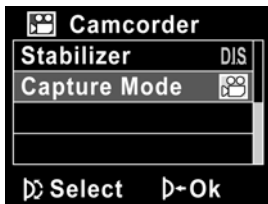

4. Press the **MENU** button again to exit the menu.

4.2 Movie playback menu

Use the playback menu to manage the files stored in the internal memory or on the SD card.

4.2.1 Delete

Use this function to delete files.

1. Turn the video camera on and ensure it is in **Movie** mode. Press the **Playback** button and then press the **MENU** button to display the **Movie Playback** menu.
2. Use the scroll wheel to select **Delete One** or **Delete All** options.

If you select **Delete One**, the playback screen appears again. Use the scroll wheel to locate the file you want to delete and press inwards to delete.



If you select **Delete All**, press the scroll wheel inwards to display the submenu.



- Use the scroll wheel to select ✓ and press the scroll wheel inwards to delete.



- Press the **MENU** button again to exit the menu.

- Note:** Once deleted, files cannot be recovered so make sure you have a backup before you delete. Files that have been protected will not be deleted. You have to unlock the files first before deleting them.

4.2.2 Protect

Use this function to lock files to prevent accidental deletion.

1. Turn the video camera on and ensure it is in **Movie** mode. Press the **Playback** button and then press the **MENU** button to display **Movie Playback** menu.
2. Use the scroll wheel to select the **Protect** option. Then playback screen appears again. Use the scroll wheel to locate the file you want to protect and press inwards to confirm. A lock  icon is displayed to show that the file is protected.



- **Note:** To unlock a file, repeat the above steps. The lock icon  disappears when the file is unlocked.

3. Press the **MENU** button again to exit the menu.

4.2.3 Autoplay

Use this function to continuously play all movie clips stored in the memory card.

1. Turn the video camera on and ensure it is in **Movie** mode. Press the **Playback** button and then press the **MENU** button to display the **Movie Playback** menu.
2. Use the scroll wheel to select the **Autoplay** option and press the scroll wheel inwards to show the submenu.
3. Use the scroll wheel to select and press the scroll wheel inwards to confirm.



4. Press the **Menu** button again to exit the menu.
5. Press the scroll wheel to start continuous playing of movie clips.

4.3 Photo menu

In **Photo** mode, press the **MENU** button to show the Photo Options menu.

4.3.1 White balance

Use this option to correct color difference due to lighting conditions.

1. Turn the video camera on and ensure it is in **Photo** mode.
2. Press the **MENU** button and use the scroll wheel to highlight the **White Balance** option. Press the scroll wheel inwards to display the submenu.
3. Use the scroll wheel to select **Auto**, **Sunny**, **Cloudy**, **Tungsten**, or **Fluorescent**. Press the scroll wheel inwards to confirm.

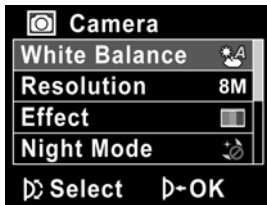

4. Press the **MENU** button again to exit the menu.

4.3.2 Resolution

Use this option to set the size of the captured image. Larger images contain more detail and therefore use more memory space.

1. Turn the video camera on and ensure it is in **Photo** mode.
2. Press the **MENU** button and use the scroll wheel to highlight the **Resolution** option. Press the scroll wheel inwards to display the submenu.
3. Use the scroll wheel to select **3M**, **5M** or **8M**. Press the scroll wheel inwards to confirm.

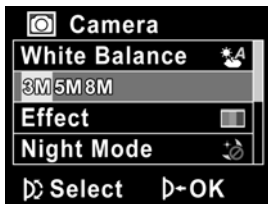
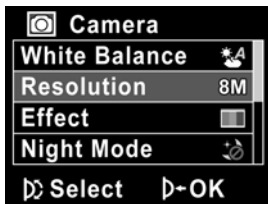

4. Press the **MENU** button again to exit the menu.

4.3.3 Color effect

The camera can capture standard color images, black and white images, or sepia tone to give an old-fashioned look.

1. Turn the video camera on and ensure it is in **Photo** mode.
2. Press the **MENU** button and use the scroll wheel to highlight the **Effect** option. Press the scroll wheel inwards to display the submenu.
3. Use the scroll wheel to select **Color**, **B & W**, or **Sepia**. Press the scroll wheel inwards to confirm.



4. Press the **MENU** button again to exit the menu.

4.3.4 Night mode

Use this function to shoot a better video clip quality in dark environments.

1. Turn the video camera on and ensure it is in **Movie** mode.
2. Press the **MENU** button and use the scroll wheel to highlight the **Night Mode** option. Press the scroll wheel inwards to display the submenu.
3. Use the scroll wheel to select **Off** or **Night mode** option. Press the scroll wheel inwards to confirm.

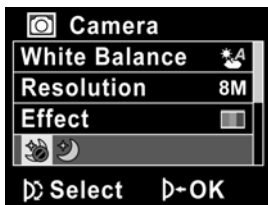
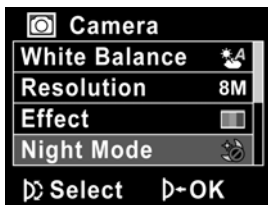

4. Press the **MENU** button again to exit the menu.

4.3.5 Self timer

Use the self timer function to take a photo of yourself.

1. Turn the video camera on and ensure it is in **Photo** mode.
2. Press the **MENU** button and use the scroll wheel to highlight the **Selftimer** option. Press the scroll wheel inwards to display the submenu.
3. Use the scroll wheel to select **Off**, **5 seconds**, or **10 seconds** options. Press the scroll wheel inwards to confirm.



4. Press the **MENU** button again to exit the menu.

4.4 Photo playback menu

4.4.1 Delete

Use this function to delete files.

1. Turn the video camera on and ensure it is in **Photo** mode. Press the **Playback** button and then press the **MENU** button to display the **Photo Playback** menu.
2. Use the scroll wheel to select **Delete One** or **Delete All** options.

If you select **Delete One**, the playback screen appears again. Use the scroll wheel to locate the file you want to delete and press inwards to delete.



If you select **Delete All**, press the scroll wheel inwards to display the submenu.



- Use the scroll wheel to select \surd and then press the scroll wheel inwards to delete.



- Press the **MENU** button again to exit the menu.

- Note:** Once deleted, files cannot be recovered so make sure you have a backup before you delete. Files that have been protected will not be deleted. You have to unlock the files first before deleting them.

4.4.2 Protect

Use this function to protect files.

1. Turn the video camera on and ensure it is in **Photo** mode. Press the **Playback** button and then press the **MENU** button to display the **Photo Playback** menu.
2. Use the scroll wheel to select the **Protect** option. Then playback screen appears again. Use the scroll wheel to locate the file you want to protect and press inwards to confirm. A lock  icon is displayed to show that the file is protected.



- **Note:** To unlock a file, repeat the above steps. The lock icon  disappears when the file is unlocked.

3. Press the **MENU** button again to exit the menu.

4.4.3 Slide show

The camera includes a slide show function, which displays each image in turn with a regular interval between pictures.

1. Turn the video camera on and ensure it is in **Photo** mode. Press the **Playback** button and then press the **MENU** button to display the **Photo Playback** menu.
2. Use the scroll wheel to select the **Autoplay** option and press the scroll wheel inwards. The images will be displayed automatically.



3. Press the scroll wheel or **Playback** button to pause / play the slideshow. Press the **MENU** button to stop the slide show.
4. Press the **MENU** button again to exit the menu.

4.4.4 DPOF

Use the DPOF (Digital Print Order Format) function to tag pictures stored in the memory card with print information.

1. Turn the video camera on and ensure it is in **Photo** mode. Press the **Playback** button and then press the **MENU** button to display the **Photo Playback** menu.
2. Use the scroll wheel to highlight the **DPOF** option. Press the scroll wheel inwards to display the submenu.



3. Use the scroll wheel to select and press inwards to confirm.



4. Press the **MENU** button again to exit the menu. A **DPOF**  icon is displayed to show that the file is ordered to print.

• **Notes:**

1. A memory card is required for DPOF function.
2. If DPOF is set, all photos are ordered to print.

4.5 System menu

The system menu is used to configure miscellaneous camera functions.

4.5.1 Setting the beep

See section 2.5.3 "Setting the Beep".

4.5.2 Histogram Mode

Use this function to display a histogram graph on the LCD screen. This function can help you to capture a better photo/video clip.

1. Turn on the video camera and switch to **SET** mode.
2. Use the scroll wheel to highlight the **Histogram** option. Press the scroll wheel inwards to display the submenu.
3. Use the scroll wheel to select **Histogram** or **Off** options. Press the scroll wheel inwards to confirm.



4.5.3 Auto power off

Use this function to switch the camera off automatically after a period of inactivity for power saving.

1. Turn on the video camera and switch to **SET** mode.
2. Use the scroll wheel to highlight the **Auto Power Off** option. Press the scroll wheel inwards to display the submenu.
3. Use the scroll wheel to select **Off**, **1 minute**, or **5 minutes**. Press the scroll wheel inwards to confirm.



4.5.4 TV standard

Use the TV option to set the TV system for the area.

1. Turn on the video camera and switch to **SET** mode.
2. Use the scroll wheel to highlight the **TV standard** option. Press the scroll wheel inwards to display the submenu.
3. Use the scroll wheel to select **NTSC** or **PAL**, and press the scroll wheel inwards to confirm.



4.5.5 Format

Use this function to format the current storage media. This format action will delete everything on the media.

1. Turn on the video camera and switch to **SET** mode.
2. Use the scroll wheel to highlight the **Format** option. Press the scroll wheel inwards to display the submenu.
3. Use the scroll wheel to select **X** or **✓**, and press the scroll wheel inwards to confirm.

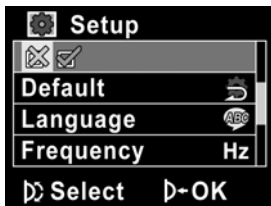
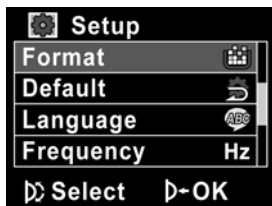

4. The current media (memory card or internal memory) is formatted.

4.5.6 Default

Use this option to reset all settings to the default settings.

1. Turn on the video camera and switch to **SET** mode.
2. Use the scroll wheel to highlight the **Default** option. Press the scroll wheel inwards to display the submenu.
3. Use the scroll wheel to select **X** or **✓**, and press the scroll wheel inwards to confirm.

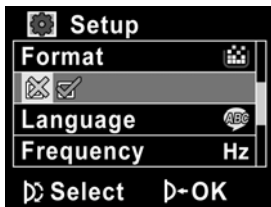
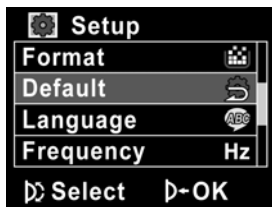

4.5.7 Language

See section 2.5.2 "Setting the language".

4.5.8 Frequency

Use the Frequency option to set the frequency system for your area.

To set the frequency:

1. Turn on the video camera and switch to **SET** mode.
2. Use the scroll wheel to highlight the **Frequency** option. Press the scroll wheel inwards to display the submenu.
3. Use the scroll to select **50 Hz** or **60 Hz**. Press the scroll wheel inwards to confirm.

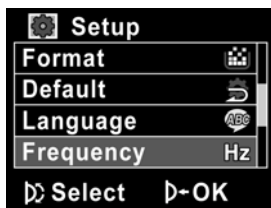

4.5.9 Date/time

See section 2.5.1 "Setting the date and time".

5 Installing the software

Read this section to learn how to install the software for the camera.

5.1 Presto! Video Works

Presto! Video Works is an advanced software application for editing video.

To install Presto! Video Works:

1. Insert the supplied CD into the CD-ROM drive.
2. If the CD-ROM does not automatically boot, use Windows Explorer to execute the **InstallMgr.exe** file in the root directory.

The following screen is displayed.



Install button

3. Click the **Install** button to begin the installation process and follow the instructions on-screen.

More information about Presto! Video Works 6 can be found in the help files when the application is started.

5.2 Presto! Mr. Photo

Presto! Mr. Photo is an advanced photo editing software application.

To install Presto! Mr. Photo:

1. Insert the supplied CD into the CD-ROM drive.
2. If the CD-ROM does not automatically boot, use Windows Explorer to execute the **InstallMgr.exe** file in the root directory.

The following screen is displayed.



3. Click the **Install** button to begin the installation process and follow the instructions on-screen.

More information about Presto! Mr. Photo can be found in the help files when the application is started.

5.3 Quick Time

Quick Time is an easy-to-use application for playing the video clips stored in the camera or on the SD/MMC card.

To install the Quick Time:

1. Insert the supplied CD into the CD-ROM drive.
2. If the CD-Rom doesn't automatically boot, use Window Explore to execute the InstalMgr.exe file in the root directory.

The following screen is displayed:



3. Click the **Install** button to begin the installation process and follow the instructions on-screen.

More information about Quick Time can be found in the help files when the application is started.

Appendix

Specifications

General	
Imaging sensor	1/2.5" CMOS 5.0 Megapixel sensor
Active pixels	5.0 Megapixel
Storage media	Built-in 128 MB flash memory (approx. 90 MB available for image storage) SD Card, SDHC compatible (up to SDHC 8GB Class 6)
Sensor sensitivity	Auto
Color effects	Color/B&W/Sepia
Lens	Fixed lens Wide: F/3.2, f=7.5mm
Focus range	Normal: 1.5m~infinity Macro: 15~16cm
Still image	Formats: JPEG (EXIF 2.2), DCF, DPOF Resolution: 3M, 5M, 8M (Firmware interpolation)

General

Movie clips	Format: H.264 (MOV) Resolution: QVGA (30 fps), WVGA (30 fps), HD 720P (30 fps)
Zoom	Movie: Digital Zoom 3X Camera: Digital Zoom 3X Still Image Playback: Digital Zoom 8X (max.)
Sensor Sensitivity	Auto
TFT Monitor	3" TFT (960 x 240 pixels)
LED Light	< 1.0 m range Movie: On / Off Camera: On / Off
White balance	Auto/Sunny/Cloudy/Tungsten/ Fluorescent
EV compensation	-2.0 EV~+2.0 EV
Self-timer	Off, 5, 10 seconds
PC interface	MSDC: USB 2.0 (high speed)
TV out format	NTSC/PAL / HDMI

Shutter	Electronic shutter 1~1/2000 second
Auto power off	Off, 1 min., 5 min.
Power supply	Li-ion Battery NP-40 or 4 x "AAA" (Alkaline / Ni-cd / Ni-MH)
Dimension	41 (W) x 68 (H) x 111(D) mm
Weight	Approx. 227± 5g (without batteries)

Design and specifications are subject to change without prior notice.

Troubleshooting

Problem	Possible Cause	Solution
Cannot turn on the video camera.	The batteries are not inserted correctly. The batteries have no power.	<ul style="list-style-type: none">• Insert the batteries correctly. (See 2.2 Inserting the batteries.)• Replace the batteries
The camera suddenly turns off.	The auto power off function was enabled. The camera is running out of battery power.	<ul style="list-style-type: none">• Turn the power on again.• Replace the batteries.
The captured image is not stored in memory.	Before the image is saved the power has been cut off.	When the battery indicator turns red, replace the batteries immediately.

<p>The camera turns off when capturing image using self-timer.</p>	<p>The camera is running out of battery power.</p>	<ul style="list-style-type: none"> • Replace the batteries.
<p>The image is out of focus.</p>	<p>The subject is beyond focus range.</p>	<ul style="list-style-type: none"> • Please take a picture within the available focus range and choose normal or macro mode. (See 3.2.2 Using the macro function).
<p>Memory card cannot be used.</p>	<p>The memory card is protected.</p> <p>The memory card contains non-DCF images taken by other cameras.</p>	<ul style="list-style-type: none"> • Unlock the memory card. <p>Format the memory card. (See 4.5.5 Format.) Before formatting the card, ensure you back up the files.</p>

All buttons are inactive.	Short circuit occurred when connecting the camera with other devices.	<ul style="list-style-type: none">• Remove the batteries from the camera and insert again.
---------------------------	---	--

Website:

Please visit our website at www.dxgusa.com for any product updates or special announcements.

You can also check out our online support desk where you can register your product, send emails to our technical support, and find a list of frequently asked questions (FAQs).



DXG USA

Free Manuals Download Website

<http://myh66.com>

<http://usermanuals.us>

<http://www.somanuals.com>

<http://www.4manuals.cc>

<http://www.manual-lib.com>

<http://www.404manual.com>

<http://www.luxmanual.com>

<http://aubethermostatmanual.com>

Golf course search by state

<http://golfingnear.com>

Email search by domain

<http://emailbydomain.com>

Auto manuals search

<http://auto.somanuals.com>

TV manuals search

<http://tv.somanuals.com>