



MXDM66

INSTALLATION/OWNER'S MANUAL

AM/FM/CD/MP3/WMA/USB/3.5mm Marine Receiver with Detachable Face



Preparation

Please read entire manual before installation.

Before You Start

- Disconnect negative battery terminal. Consult a qualified technician for instructions.
- Avoid installing the unit where it would be subject to high temperatures, such as from direct sunlight, or where it would be subject to dust, dirt or excessive vibration.

Getting Started

- Remove trim ring from unit.
- Remove 2 transit screws located on top of the unit.
- Insert the supplied keys into the slots as shown, and slide the unit out of the mounting sleeve.
- Install mounting sleeve into opening, bending tabs to secure.
- Connect wiring harness and antenna. Consult a qualified technician if you are unsure.
- Certain vehicles may require an installation kit and/or wiring harness adapter (sold separately).
- Test for correct operation and slide into mounting sleeve to secure.
- Snap trim ring into place.

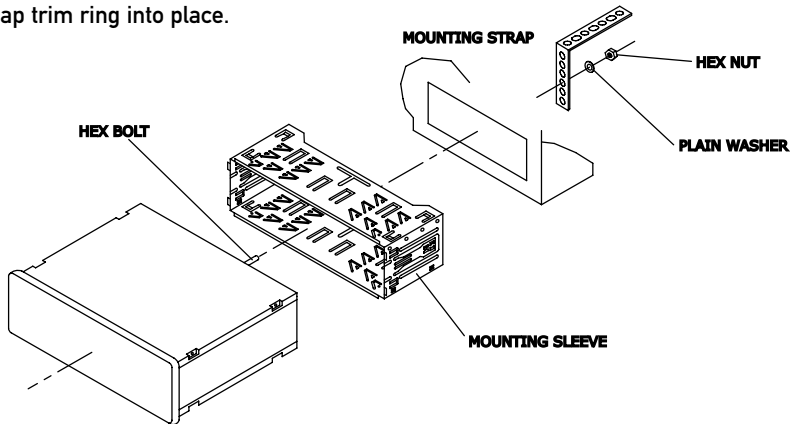
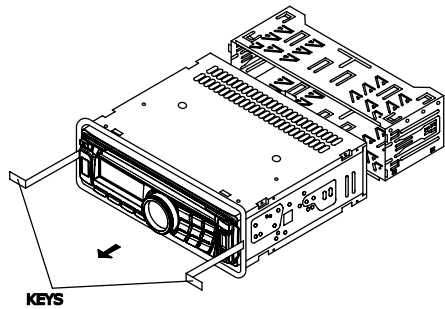

TYPICAL FRONT-LOAD DIN MOUNTING METHOD

Wiring Diagram

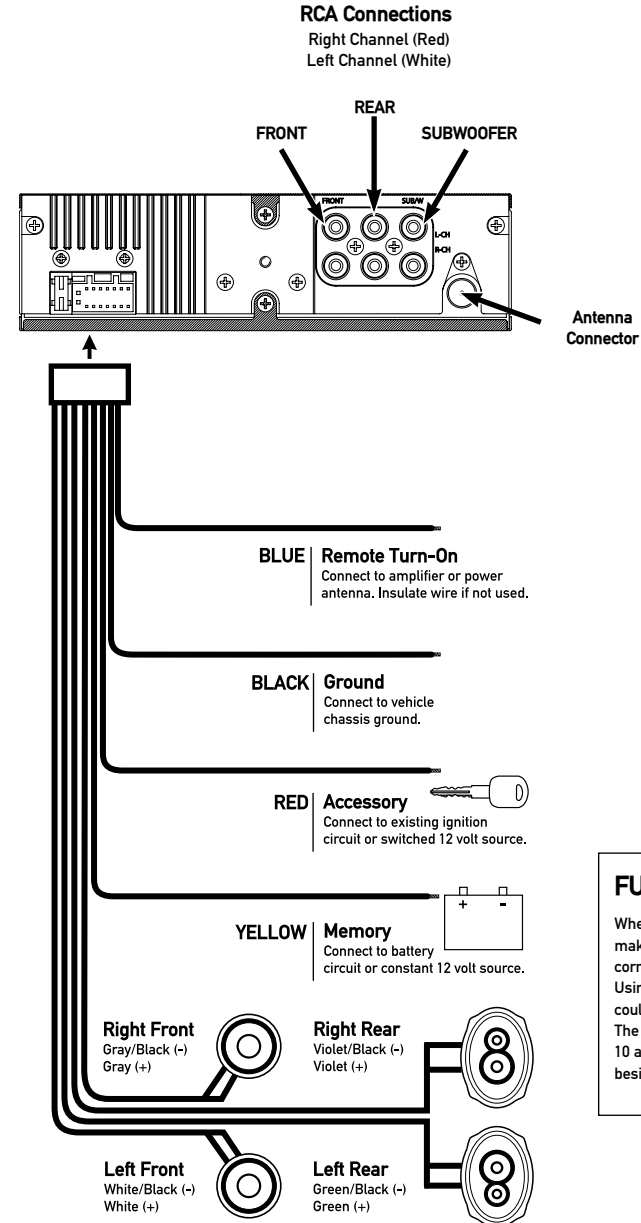

FUSE

When replacing the fuse, make sure new fuse is the correct type and amperage. Using an incorrect fuse could damage the radio. The MXDM66 uses one 10 amp ATM fuse located beside the wiring connector.

Control Locations - Receiver

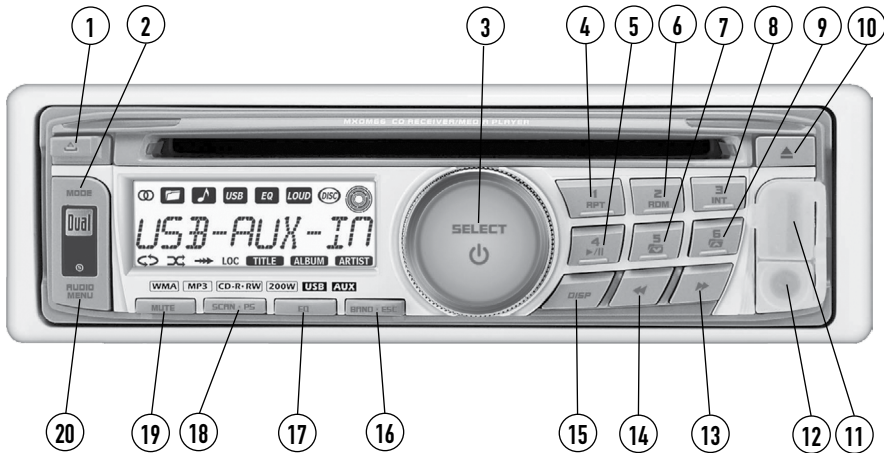

- | | |
|------------------------|---|
| ① Release | ⑪ USB Port (with silicone cover) |
| ② Mode | ⑫ Auxiliary Input (with silicone cover) |
| ③ Power (⏻)/Select | ⑬ Tune/Track Up |
| ④ Preset 1/Repeat | ⑭ Tune/Track Down |
| ⑤ Preset 4/Play/Pause | ⑮ Display |
| ⑥ Preset 2/Random | ⑯ Band/ESC |
| ⑦ Preset 5/Folder Down | ⑰ EQ |
| ⑧ Preset 3/Intro | ⑱ Scan/PS |
| ⑨ Preset 6/Folder Up | ⑲ Mute |
| ⑩ Eject | ⑳ Audio/Menu |



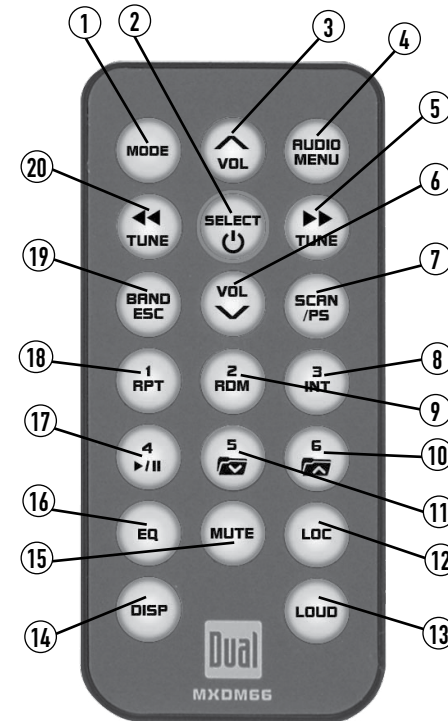

The MXDM66 allows playback of your favorite MP3 and WMA files recorded on CD-R and CD-RW discs. Its powerful on-board DSP processor decodes the compressed audio while maintaining near-CD sound quality. An internal SRAM buffer provides ESP (Electronic Skip Protection) to virtually eliminate skipping and allows alphanumeric or direct track search - even while a song is currently playing!

Control Locations - Remote



- | | |
|----------------------|-------------------------|
| ① Mode | ⑪ Preset 5/Folder Down |
| ② Power (⏻)/Select | ⑫ Local/Distance Tuning |
| ③ Volume Up | ⑬ Loudness |
| ④ Audio/Menu | ⑭ Display |
| ⑤ Tune/Track Up | ⑮ Mute |
| ⑥ Volume Down | ⑯ EQ |
| ⑦ Scan/PS | ⑰ Preset 4/Play/Pause |
| ⑧ Preset 3/Intro | ⑱ Preset 1/Repeat |
| ⑨ Preset 2/Random | ⑲ Band/ESC |
| ⑩ Preset 6/Folder Up | ⑳ Tune/Track Down |

General Operation

Faceplate Removal	Press RELEASE and pull away from the left side to remove. To re-install, insert right side of faceplate first then push left side to secure.
Semi-Permanent Faceplate Installation	Remove trim ring and install supplied #1 x 7/32" Phillips head screw through left side of mounting frame into faceplate.
Power On/Off	Press  or any other button (except eject) to turn the unit on. Inserting a disc will turn the unit on automatically. Press and hold  to turn the unit off.
Mode	Press MODE to select between AM/FM, CD player, auxiliary input and USB. Modes of operation are indicated in the display. Note: CD mode will not appear unless a CD is inserted.
Auxiliary Input	Insert 3.5 mm plug to connect your portable audio device.
Volume	Adjust volume using rotary encoder (00-46).
Mute	Press MUTE to silence the audio. "MUTE" will flash in the display. Press MUTE again to cancel.
Preset EQ Curves	Press EQ to enter EQ setup menu, then use the rotary encoder to select between POP, JAZZ, CLASSIC, BEAT, ROCK and FLAT (default) equalization curves. Any adjustment to the Bass or Treble settings automatically cancels the current EQ curve (if one is selected).
Reset	Press to RESET the unit upon initial installation or if abnormal operation occurs. The reset button is located behind the faceplate.
Display	Press DISP to select between clock and different types of information, such as radio frequency, CD track or MP3/USB song information.
Set the Clock	With the unit on, press and hold DISP until the clock begins to flash, then release. Press TUNE  to adjust the hours and TUNE  to adjust the minutes. Press DISP momentarily to save the selected time.
12/24-hour Clock	The clock will display 12-hour AM/PM time in USA frequency spacing mode (PM 10:00). In European frequency spacing mode, the clock will display 24-hour time (22:00).

General Operation

Setup Menu	Press and hold AUDIO/MENU for more than 3 seconds to access the setup menu, then press AUDIO/MENU to cycle through menu options. When desired option appears in the display, rotate the rotary encoder left/right to adjust or activate the desired function. Press ESC to exit the menu at any time.
-------------------	---

Setup Menu

Menu Function	Options	Action
Auto Station Store	AUTO STORE	Press SELECT to seek and save 6 strong stations in the current band. Note: This option only appears in Tuner mode.
	LOUD OFF	Disables the loudness function.
Loudness Curve	LOUD ON	Enables the loudness function. Activating this feature will enhance the bass and treble frequencies when listening to music at low volumes.
Tuner Frequency Spacing	FREQ USA	Programs unit to USA tuner spacing. (200kHz for FM and 10kHz for AM)
	FREQ EUR	Programs unit to European tuner spacing. (50kHz for FM and 9kHz for AM)
Clock Display	CLK OFF	Programs unit to not display the clock when the power is off.
	CLK ON	Programs unit to display the clock when the power is off.
Auxiliary Input	AUX ON	Enables the front panel 3.5mm auxiliary input.
	AUX OFF	Disables the auxiliary input.
Beep Confirmation	BEEP OFF	Disables the confirmation beep.
	BEEP ON	Enables the confirmation beep.
Programmable Turn On Volume	PRO-VOL #	Programs unit to turn on at a specific volume (default is OFF).
Local/Distance Tuning	LOCAL OFF	Activates distance tuning.
	LOCAL ON	Activates local tuning for strong station reception only.
Power on Message	MSG OFF	Disables power on message.
	MSG ON	Enables power on message to be displayed.
Scrolling Option	SCROLL ONCE	Programs unit to scroll once, then show the first 10 characters on the display.
	SCROLL ON	Programs unit to scroll continuously.
	SCROLL OFF	Programs unit to show the first 10 characters on the display.
Illumination Dimmer	DIMMER HI	Programs unit to the brightest illumination level.
	DIMMER MED	Programs unit to the middle illumination level.
	DIMMER LOW	Programs unit to the dimmest illumination level.
Demonstration Mode	DEMO OFF	Disables the demonstration mode.
	DEMO ON	Enables the "FULL SPEED USB INPUT " message.

General Operation

Escape	Press ESC to exit any menu adjustment mode.
Audio	Press AUDIO/MENU momentarily to select between Volume (default), Bass, Treble, Balance, Fader, Subwoofer and Source Volume Level. <div style="border: 1px solid black; padding: 2px; text-align: center;"> → VOLUME → BASS → TREBLE → BALANCE → FADER → SUBWOOFER → SOURCE LEVEL → </div>
Bass	Press AUDIO/MENU until BASS appears, then press SELECT to confirm. Rotate encoder left/right to adjust (-6 minimum / +6 maximum).
Treble	Press AUDIO/MENU until TREBLE appears, then press SELECT to confirm. Rotate encoder left/right to adjust (-6 minimum / +6 maximum). Note: Any adjustment to the Bass or Treble settings automatically cancels the current EQ curve (if one is selected). Note: Bass and Treble settings are retained for each mode individually.
Balance	Press AUDIO/MENU until BAL appears, then press SELECT to confirm. Rotate encoder left/right to adjust (BAL L 12-BAL 00-BAL R 12). BAL 00 represents equal balance.
Fader	Press AUDIO/MENU until FADER appears, then press SELECT to confirm. Rotate encoder left/right to adjust (FAD F 12-FAD 00-FAD R 12). FAD 00 represents equal fader.
Subwoofer	Press AUDIO/MENU until SUB-W appears, then press SELECT to confirm. Rotate encoder left/right to adjust (0-12). Adjusting levels to 0 turns the subwoofer off.
Source Volume Level	The source volume level control allows a gain adjustment for each audio source: AM, FM, CD, AUX and USB. Set the source volume level for each mode, depending on the relative volume of each audio source. To set the source volume level, press AUDIO/MENU until SRC LEVEL appears. After one second, the current mode will appear on the display. Turn the rotary encoder to adjust the audio level of the current source (-6 minimum/+6 maximum). Note: Only the current mode will be available for adjustment. To adjust another mode of operation, press MODE until the desired mode is selected, then set the source volume level for that mode.





AM/FM Tuner Operation

Seek Tuning	Press TUNE ◀◀ or TUNE ▶▶ for more than one second to seek the next strong station.
Manual Tuning	Press TUNE ◀◀ or TUNE ▶▶ momentarily to move radio frequency up or down one step at a time. Press and hold to advance quickly.
Scan Tuning	Press SCAN to preview strong stations on the current band, pausing for five seconds at each. Press SCAN again to cancel.
Band	Press BAND to select between FM1, FM2, FM3, AM1 and AM2 bands.
Storing and Recalling Station Presets	Up to 18 FM stations and 12 AM stations can be stored. To store a station, select the desired band and station. Press and hold the desired preset button (1-6) for more than two seconds. When stored, the preset number will appear in the display. The station can be recalled anytime by pressing the corresponding preset button.
Preset Scan	Press PS for more than two seconds to scan presets 1-6 on the current band, pausing for five seconds at each. Press PS again to cancel.

CD Player Operation

Insert CD	With the label facing up, insert a standard size CD into the CD slot. The CD will automatically begin playback.
Eject CD	Press EJECT to eject the CD. The unit will change to previous mode of operation (tuner, AUX or USB). If the disc is not removed within 10 seconds, the unit will reload the disc. The unit does not have to be turned on to eject CD.
Track Select	Press TRACK ▶▶ to skip to the beginning of the next track. Press TRACK ◀◀ to return to the beginning of the current track. Pressing TRACK ◀◀ again skips to the beginning of the previous track.
Fast Forward and Reverse	Press and hold TRACK ▶▶ or TRACK ◀◀ to fast forward or reverse a track.
Pause	Press ▶/ to temporarily stop CD playback. Press ▶/ again to resume playback.
Repeat	Press RPT to enter the Repeat menu, then turn the rotary encoder to select one of the following options: <ul style="list-style-type: none"> • OFF - Cancels the RPT function. • TRACK - Continuously repeats selected track.
Random	Press RDM to enter the Random menu, then turn the rotary encoder to select one of the following options: <ul style="list-style-type: none"> • OFF - Cancels the RDM function. • ALL- Plays all tracks in random order. <p>Note: Random mode is retained in memory when selecting between tuner, CD, AUX, and USB modes and when the unit is turned on/off.</p>
Intro	Press INT to enter the Intro menu, then turn the rotary encoder to select one of the following options: <ul style="list-style-type: none"> • OFF - Cancels the INT function. • ALL - Plays the first 10 seconds of each track.
CD-R/CD-RW Compatibility	Some CD-Rs and CD-RWs may be incompatible with this unit, depending on media type and recording method. In addition, the following CDs may be incompatible with this unit: CDs exposed to extreme temperatures or direct sunlight for extended periods of time, CDs recorded in which a recording session failed or a re-recording was attempted and encrypted or copy-protected CDs that do not conform to the audio CD-DA red book recording standard.

CD Player Operation - MP3/WMA Files

Playing an MP3/WMA Disc	When an MP3/WMA encoded disc is first inserted, "READING" will appear in the display. Depending on the number of files and folders, this may take several seconds.
Displaying Information	Press DISP to select between track name (default), song title, artist, track number or clock & elapsed time. <p>"NO ID3 TAG" will be displayed if the MP3 file contains no ID3 tag information.</p> <p>"UNKNOWN" will be displayed if the WMA file contains no WMA tag information.</p> <p>"ROOT" will be displayed if the directory name of a root folder is not labeled.</p>
Title Icon 	This icon will illuminate when the song title is displayed.
Artist Icon 	This icon will illuminate when the artist name is displayed.
Folder Icon 	This icon will illuminate when the folder name is displayed.
Track Icon 	This icon will illuminate when the track name is displayed.
Character Support	Maximum character display information <ul style="list-style-type: none"> • Track name – 32 character maximum • Directory name – 23 character maximum • *Song title – 30 character maximum • *Artist name – 30 character maximum <p>*Song title and Artist Name will only be displayed if included with the MP3/WMA file.</p> <p>When referring to MP3/WMA playback, the following terms are synonymous:</p> <ul style="list-style-type: none"> • File name and track name • Folder name and directory name



CD Player Operation - MP3/WMA Files

Folder/File Search Mode Press **SELECT** to enter the folder/file search mode. The head unit will read the CD, and a list of folders and files from the CD will be displayed, starting from the current directory.

Folder/File Navigation Turn the rotary encoder to cycle through the list of folders and files. The current selection will flash in the display.

Folders will be displayed first, followed by any files.

→ FOLDER 1 → FOLDER 2 → FILE 1 → FILE 2 → Etc... →

- When a folder name is being displayed,  will illuminate.
- When a file name is being displayed,  will illuminate.

Press **SELECT** when a folder is displayed to change directories and begin displaying the contents of that folder.



Navigating Note When searching the contents of a subfolder, select "." at the top of the menu to go up one folder level.

Press **ESC** from the root directory to exit search mode.

After navigating to desired file, the track name will be displayed by default. Press **DISP** momentarily to cycle through other display options:

→ TRACK NAME → TITLE → ARTIST → TRACK NUMBER → CLOCK & ELAPSED TIME →

CD Player Operation - MP3/WMA Files

Folder Access Press  to select the previous folder.
Press  to select the next folder.

Note: Folder access is only available on MP3/WMA discs recorded with more than one folder.

Repeat Press **RPT** to enter the Repeat menu, then turn the rotary encoder to select one of the following options:

- OFF - Cancels the **RPT** function.
- TRACK - Continuously repeats selected track.
- FOLDER - Continuously repeats all files in selected folder.

Random Press **RDM** to enter the Random menu, then turn the rotary encoder to select one of the following options:

- OFF - Cancels the **RDM** function.
- ALL - Plays all tracks in random order.
- FOLDER - Plays all tracks in folder in random order.

Note: Random mode is retained in memory when selecting between tuner, CD, AUX and USB modes and when the unit is turned on/off.

Intro Press **INT** to enter the Intro menu, then turn the rotary encoder to select one of the following options:

- OFF - Cancels the **INT** function.
- ALL - Plays first 10 seconds of each track.
- FOLDER - Plays first 10 seconds of each track in folder.

Note: Folder repeat, random and intro options only function on MP3/WMA discs recorded with more than one folder.

CD Player Operation - MP3/WMA Files

Media Compatibility	<p>The following types of discs/files are compatible:</p> <ul style="list-style-type: none"> • CD-ROM (ISO), CD-R, CD-RW • CD-DA • MP3 data • WMA data <p>The following types of discs/files are not compatible:</p> <ul style="list-style-type: none"> • WMA files that are protected by DRM (Digital Rights Management). • WMA lossless format • Discs recorded with Track At Once or packet writing • MP3 PRO format • MP3 playlists • WAV format
Playback Order	<p>MP3/WMA playback sequence is based on recorded order of files and begins in the root folder of the disc. Any empty folders or folders that do not include MP3/WMA files are skipped. This unit may not play files in the order they were recorded in. Refer to your recording software's user's manual for more information.</p>
Compatible Recording Formats	<ul style="list-style-type: none"> • ISO9660 level 1 • ISO9660 level 2 • Yellow Book MODE 1 • Yellow Book MODE 2 FORM 1 • Multi session • Maximum folders and files - 256 • Maximum folder levels - 8 • MPEG-1/2/2.5 Audio Layer-3 <p>ISO9660 standards:</p> <ul style="list-style-type: none"> • Maximum nested folder depth is 8 (including the root folder). • Valid characters for folder/file names are letters A-Z (all caps), numbers 0-9, and "_" (underscore). Some characters may not be displayed correctly, depending on the character type. • This device can play back discs in Joliet, Romeo, and other standards that conform to ISO9660. MP3/WMA written in the formats other than the above may not play and/or their file names or folder names may not be displayed properly.

CD Player Operation - MP3/WMA Files

Additional MP3/WMA Information	<p>An internal buffer provides ESP (Electronic Skip Protection) to virtually eliminate skipping.</p> <p>When playing a disc recorded with regular audio files (CD-DA or .WAV) and MP3/WMA files, the unit will play the MP3/WMA files only.</p> <p>Only MP3 files with filename extension (.mp3) can be played. Only WMA files with filename extension (.wma) can be played.</p> <p>Do not attempt to play discs which contain non-MP3/WMA files with the MP3/WMA extension.</p>
Sampling Frequency Rates	<p>MP3 8kHz ~ 48kHz</p> <p>WMA 32kHz ~ 48kHz</p>
Transfer Bit rates	<p>MP3 32kbps ~ 320kbps constant Variable bit rates</p> <p>WMA 32kbps ~ 192kbps constant Variable bit rates</p>
MP3 Tag Display	<p>Note: Some files may not play or be displayed correctly, depending on sampling rates and bit rates.</p> <p>ID3 tags Version 1.0 to 2.0</p>
Recommended Settings	<p>For best results, use the following settings when burning an MP3 disc: 128kbps or higher constant bit rate 44.1kHz or higher sampling frequency</p> <p>For best results, use the following settings when burning a WMA disc: 64kbps or higher constant bit rate 32kHz or higher sampling frequency</p>

USB Operation - MP3/WMA Files (Optional)

Connecting a USB Device (sold separately)	Play MP3/WMA files from most mass storage devices by connecting them to the MXDM66's USB port.
Playing Music	When a USB device is first connected, press MODE to access USB mode. "READING" will appear momentarily in the display. Depending on the number of files and folders, this may take several seconds. If no valid MP3/WMA files are detected, "NO FILE" will be displayed and the last mode will be resumed.
Track Select	Press TRACK to skip to the beginning of the next track. Press TRACK to return to the beginning of the current track. Pressing TRACK again skips to the beginning of the previous track.
Fast Forward and Reverse	Press and hold TRACK or TRACK to fast forward or reverse a track.
Pause	Press to temporarily stop USB playback. Press again to resume playback.
File Search Step 1	The USB file search feature enables the user to browse through all files within the desired folder. Begin by selecting a specific folder to access: Press to select the previous folder. Press to select the next folder. Note: Folder access is only available on USB devices with more than one folder.
Step 2	Once the desired folder has been selected, press SELECT to enter the file search mode. When "RANDOM ALL" appears on the display, select one of the following two options: <ul style="list-style-type: none"> • Press SELECT again to begin playing all the songs on the USB device in random order. • Turn the volume knob to view all the songs in the currently selected folder.
Step 3	Once the desired song is displayed, press SELECT to begin playback of the desired song.
Note	Press ESC to exit the search mode at any time.

USB Operation - MP3/WMA Files (Optional)

Displaying Information	When a file is accessed, the clock and elapsed time will be displayed. Press DISP momentarily to select file name (default), song title, artist, track number or clock & elapsed time. <div style="border: 1px solid black; padding: 2px; display: inline-block;"> TRACK NAME TITLE ARTIST TRACK NUMBER CLOCK & ELAPSED TIME </div>
Title Icon	This icon will illuminate when the song title is displayed.
Artist Icon	This icon will illuminate when the artist name is displayed.
Folder Icon	This icon will illuminate when the folder name is displayed.
Track Icon	This icon will illuminate when the track name is displayed.
Folder Access	Press to select the previous folder. Press to select the next folder. Note: Folder access is only available on USB devices with more than one folder.
Repeat	Press RPT to enter the Repeat menu, then turn the rotary encoder to select one of the following options: <ul style="list-style-type: none"> • OFF - Cancels the RPT function. • TRACK - Continuously repeats selected track. • FOLDER - Continuously repeats all files in selected folder.
Random	Press RDM to enter the Random menu, then turn the rotary encoder to select one of the following options: <ul style="list-style-type: none"> • OFF - Cancels the RDM function. • ALL - Plays all tracks in random order. • FOLDER - Plays all tracks in folder in random order.
Intro	Press INT to enter the Intro menu, then turn the rotary encoder to select one of the following options: <ul style="list-style-type: none"> • OFF - Cancels the INT function. • ALL - Plays first 10 seconds of each track. • FOLDER - Plays first 10 seconds of each track in folder.

USB Operation - MP3/WMA Files (Optional)

Character Support	<p>Maximum character display information</p> <ul style="list-style-type: none"> • Track name – 32 character maximum • Directory name – 32 character maximum • *Song title – 32 character maximum • *Artist name – 32 character maximum <p>*Song title and artist name will only be displayed if included with the MP3/WMA file.</p>
Media Compatibility	<p>The following types of files are compatible:</p> <ul style="list-style-type: none"> • MP3 data • WMA data <p>The following types of files are not compatible:</p> <ul style="list-style-type: none"> • WMA files that are protected by DRM (Digital Rights Management). • WMA lossless format • MP3 PRO format • MP3 playlists • WAV format
Playback Order	<p>MP3/WMA playback sequence is based on order the files are copied to the USB device and begins in the root folder. Any empty folders or folders that do not include MP3/WMA files are skipped. Depending on your software, the playback order may vary.</p>
Playback Capacity	<ul style="list-style-type: none"> • Maximum number of files: 48896 • Maximum number of folders: 127 plus the root directory • Maximum number of files in each folder and root: 382 • Maximum number of folder levels (sub folders): 8 (7 levels plus the root) <p>Note: If the number of files/folders exceeds the maximum outlined above, the additional files/folders will be ignored.</p>
USB Device Compatibility	<p>Due to the differences of USB devices, some devices may not be compatible. USB devices must be 'mass storage class' and formatted to the FAT or FAT32 file system in order to ensure compatibility.</p>

USB Operation - MP3/WMA Files (Optional)

Additional MP3/WMA Information	<p>Only MP3 files with filename extension (.mp3) can be played. Only WMA files with filename extension (.wma) can be played. Do not attempt to play non-MP3/WMA files with the MP3/WMA extension.</p>
Sampling Frequency Rates	
MP3	8kHz ~ 48kHz
WMA	32kHz ~ 48kHz
Transfer Bit rates	
MP3	32kbps ~ 320kbps constant Variable bit rates
WMA	32kbps ~ 192kbps constant Variable bit rates
	<p>Note: Some files may not play or be displayed correctly, depending on sampling rates and bit rates.</p>
MP3 Tag Display	<p>ID3 tags Version 1.0 to 2.0</p> <p>Note: If an invalid ID3 tag version is detected, "NO SUPPORT" will scroll on the display.</p>



Limited One Year Warranty

This warranty gives you specific legal rights. You may also have other rights which vary from state to state.

Dual Electronics Corp. warrants this product to the original purchaser to be free from defects in material and workmanship for a period of one year from the date of the original purchase.

Dual Electronics Corp. agrees, at our option, during the warranty period, to repair any defect in material or workmanship or to furnish an equal new, renewed or comparable product (whichever is deemed necessary) in exchange without charges, subject to verification of the defect or malfunction and proof of the date of purchase. Subsequent replacement products are warranted for the balance of the original warranty period.

Who is covered? This warranty is extended to the original retail purchaser for products purchased from an authorized Dual dealer and used in the U.S.A.

What is covered? This warranty covers all defects in material and workmanship in this product. The following are not covered: software, installation/removal costs, damage resulting from accident, misuse, abuse, neglect, product modification, improper installation, incorrect line voltage, unauthorized repair or failure to follow instructions supplied with the product, or damage occurring during return shipment of the product. Specific license conditions and copyright notices for the software can be found via www.dualav.com.

What to do?

1. Before you call for service, check the troubleshooting guide in your owner's manual. A slight adjustment of any custom controls may save you a service call.
2. If you require service during the warranty period, you must carefully pack the product (preferably in the original package) and ship it by prepaid transportation with a copy of the original receipt from the retailer to an authorized service center.
3. Please describe your problem in writing and include your name, a return UPS shipping address (P.O. Box not acceptable), and a daytime phone number with your shipment.
4. For more information and for the location of the nearest authorized service center please contact us by one of the following methods:

- Call us toll-free at 1-866-382-5476
- E-mail us at cs@dualav.com

Exclusion of Certain Damages: This warranty is exclusive and in lieu of any and all other warranties, expressed or implied, including without limitation the implied warranties of merchantability and fitness for a particular purpose and any obligation, liability, right, claim or remedy in contract or tort, whether or not arising from the company's negligence, actual or imputed. No person or representative is authorized to assume for the company any other liability in connection with the sale of this product. In no event shall the company be liable for indirect, incidental or consequential damages.



Troubleshooting - General

Problem	Cause	Action
Unit will not turn on (no power)	Yellow wire not connected or incorrect voltage	Check connections for proper voltage (11~16VDC)
	Red wire not connected or incorrect voltage	Check connections for proper voltage (11~16VDC)
	Black wire not connected	Check connection to ground
	Fuse blown	Replace fuse
Unit has power (but no sound)	Speaker wires not connected	Check connections at speakers
	One or more speaker wires touching each other or touching chassis ground	Insulate all bare speaker wires from each other and chassis ground
Unit blows fuses	Yellow or red wire touching chassis ground	Check for pinched wire
	Speaker wires touching chassis ground	Check for pinched wire
	Incorrect fuse rating	Use fuse with correct rating
Excessive skipping	Unit is not mounted correctly or backstrap is not secure	Check mounting sleeve and backstrap support
	Physical defect in media (CD, CD-R or CD-RW)	Check media for scratches
ERROR-01 appears on display	Disc read error	Press EJECT or RESET
ERROR-02 appears on display	Focus error or disc is in upside down	Press EJECT or RESET
PROTECT appears on display	The WMA file is copy-protected by DRM (Digital Rights Management)	Write disc using WMA files that are not copy-protected
NO FILE appears on display	Selected file is not available in direct or alphanumeric search modes	Repeat search using valid parameters
INVALID appears on display	The file format is incompatible	Write disc using valid audio files with .mp3 or .wma file extensions
Unit will not accept a disc	CD mechanism position out of alignment	Press and hold EJECT for 3 seconds to reset CD mechanism position
	CD transit screws still in place	Remove 2 transit screws located on top of the unit
NO SUPPORT appears on display	An invalid ID3 tag version is present	Version 1.0 to 2.0 ID3 tags are supported.

Specifications

CD Player	Frequency response: 10Hz-20kHz Channel separation @ 1kHz: >65dB D/A converter: 1 Bit
FM Tuner	Tuning range: 87.5MHz-107.9MHz Usable sensitivity: 8.5dBf 50dB quieting sensitivity: 10dBf Stereo separation @ 1kHz: 40dB Frequency response: 30Hz-13kHz
AM Tuner	Tuning range: 530kHz-1710kHz Usable sensitivity: 22uV Frequency response: 30Hz-2.2kHz
General	Operating voltage: 11-16 VDC, negative ground Speaker output impedance: 4~8 ohms Line output voltage: 2 Volts RMS Dimensions: 7" x 7" x 2" (178 x 178 x 51 mm)

Design and specifications subject to change without notice.



CEA-2006 Power Standard Specifications (reference: 14.4VDC +/- 0.2V, 20Hz~20kHz)

Power Output: 17 Watts RMS x 4 channels at 4 ohms and $\leq 1\%$ THD+N
Signal to Noise Ratio: 80dB (reference: 1 watt into 4 ohms)

FCC Compliance

This device complies with Part 15 of the FCC Rules. Operation is subject to the following two conditions:

- (1) this device may not cause harmful interference, and
- (2) this device must accept any interference received, including interference that may cause undesired operation.

Warning: Changes or modifications to this unit not expressly approved by the party responsible for compliance could void the user's authority to operate the equipment.

Note: This equipment has been tested and found to comply with the limits for a Class B digital device, pursuant to Part 15 of the FCC Rules. These limits are designed to provide reasonable protection against harmful interference in a residential installation. This equipment generates, uses and can radiate radio frequency energy and, if not installed and used in accordance with the instructions, may cause harmful interference to radio communications. However, there is no guarantee that interference will not occur in a particular installation. If this equipment does cause harmful interference to radio or television reception, which can be determined by turning the equipment off and on, the user is encouraged to try to correct the interference by one or more of the following measures:

- Reorient or relocate the receiving antenna.
- Increase the separation between the equipment and receiver.
- Connect the equipment into an outlet on a circuit different from that to which the receiver is connected.
- Consult the dealer or an experienced radio/TV technician for help.



Dual Electronics Corp.
Toll Free: 1-866-382-5476

www.dualav.com
©2010 Dual Electronics Corp. All rights reserved.

NSA0610-V02

Download from Www.Somanuals.com. All Manuals Search And Download.

Free Manuals Download Website

<http://myh66.com>

<http://usermanuals.us>

<http://www.somanuals.com>

<http://www.4manuals.cc>

<http://www.manual-lib.com>

<http://www.404manual.com>

<http://www.luxmanual.com>

<http://aubethermostatmanual.com>

Golf course search by state

<http://golfingnear.com>

Email search by domain

<http://emailbydomain.com>

Auto manuals search

<http://auto.somanuals.com>

TV manuals search

<http://tv.somanuals.com>