



XDMR6850

INSTALLATION/OWNER'S MANUAL

XM Ready Multimedia Receiver with Detach Face



SATELLITE
RADIO



An optional XM Satellite Radio Receiver may be connected to the XDMR6850. XM subscription is required for reception. For more information, visit XM's website at www.xmradio.com or call 1-877-XM-RADIO. Not available in Alaska or Hawaii.



Preparation

Please read entire manual before installation.

Before You Start

- Disconnect negative battery terminal. Consult a qualified technician for instructions.
- Avoid installing the unit where it would be subject to high temperatures, such as from direct sunlight, or where it would be subject to dust, dirt or excessive vibration.

Getting Started

- Remove trim ring from unit.
- Remove 2 transit screws located on top of the unit.
- Insert the supplied keys into the slots as shown, and slide the unit out of the mounting sleeve.
- Install mounting sleeve into opening, bending tabs to secure.
- Connect wiring harness and antenna. Consult a qualified technician if you are unsure.
- Certain vehicles may require an installation kit and/or wiring harness adapter (sold separately).
- Test for correct operation and slide the unit into mounting sleeve to secure.
- Snap trim ring into place.
- Mount the iplug™ adapter to any smooth clean surface using the supplied double-sided tape or #2 x 3/8" Phillips head screws.

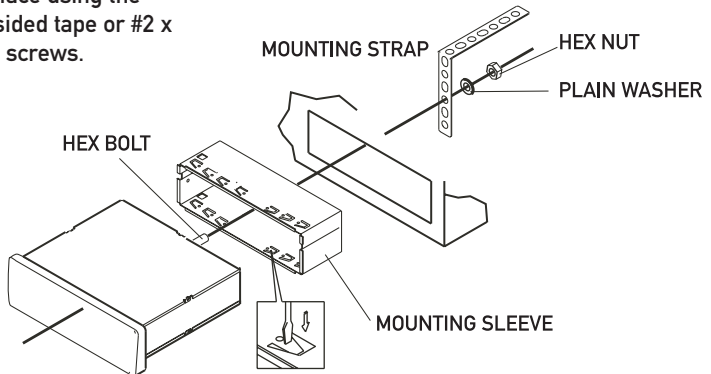
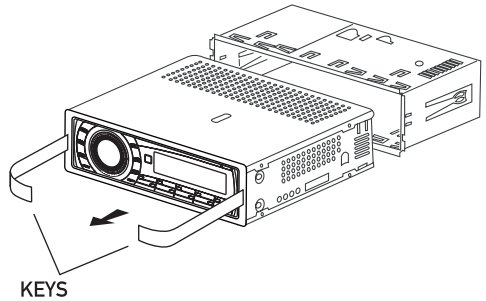

TYPICAL FRONT-LOAD DIN MOUNTING METHOD



Wiring Diagram

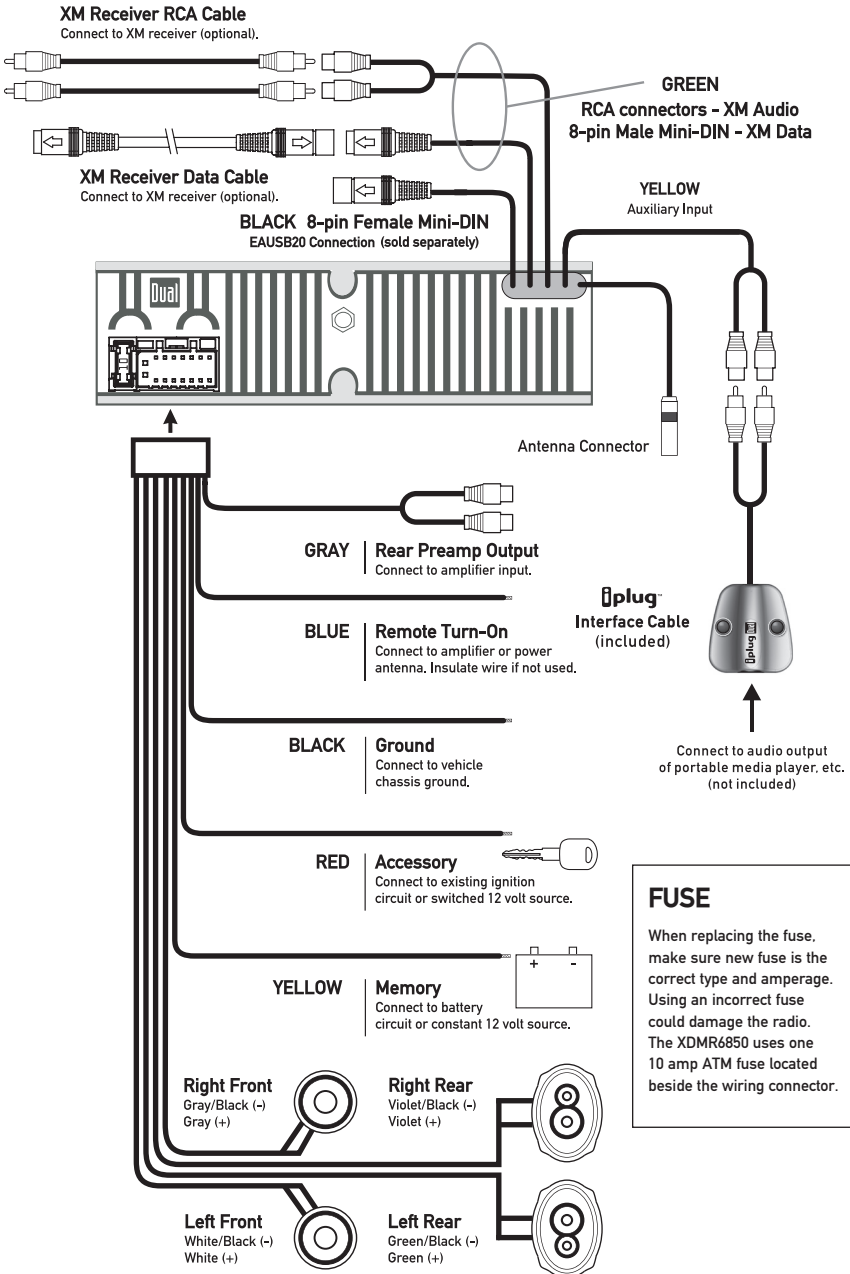

Control Locations - Receiver

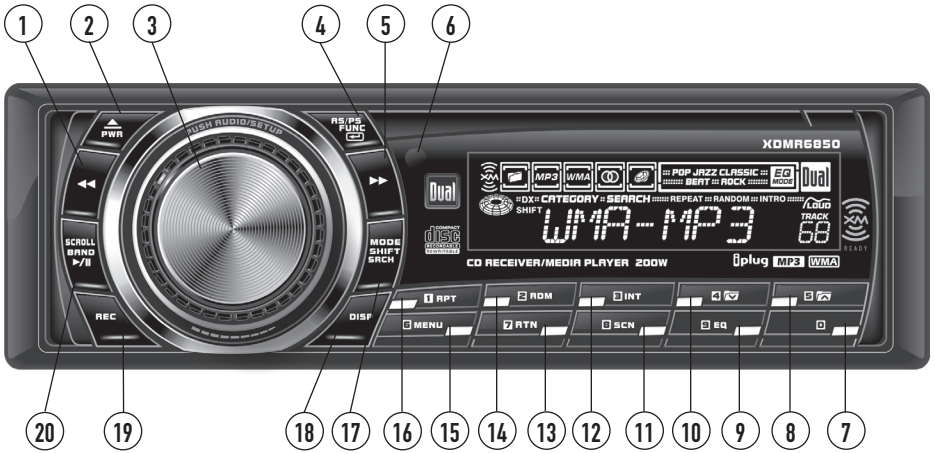

- | | |
|--------------------------|------------------------------|
| 1 Tune/Track Down | 11 *Key/Preset #8/Tuner Scan |
| 2 Power/Eject | 12 Preset #3/Intro |
| 3 Volume/Audio/Setup | 13 *Key/Preset #7/Return |
| 4 AS/PS/Enter/Function | 14 Preset #2/Random |
| 5 Tune/Track Up | 15 Preset #6/Menu |
| 6 Infrared Sensor | 16 Preset #1/Repeat |
| 7 *Key #0/Preset #10 | 17 Mode/Shift/Search |
| 8 Preset #5/Folder Up | 18 Display |
| 9 *Key/Preset #9/EQ | 19 Record |
| 10 Preset #4/Folder Down | 20 Band/Play/Pause/Scroll |

An optional XM Satellite Radio Receiver may be connected to the XDMR6850. XM subscription is required for reception. For more information, visit XM's website at www.xmradio.com or call 1-877-XM-RADIO. Not available in Alaska or Hawaii. *Function keys 7, 8, 9 and 0 apply to XM Radio and MP3/WMA operation only.

Control Locations - Remote

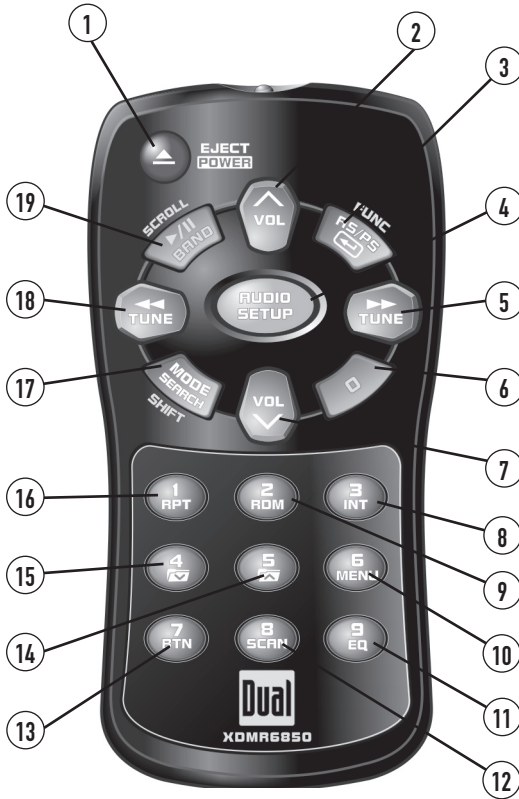

- | | |
|------------------------|-----------------------------|
| ① Power/Eject | ⑪ *Key/Preset #9/EQ |
| ② Volume Up | ⑫ *Key/Preset #8/Tuner Scan |
| ③ AS/PS/Enter/Function | ⑬ *Key/Preset #7/Return |
| ④ Audio/Setup | ⑭ Preset #5/Folder Up |
| ⑤ Tune/Track Up | ⑮ Preset #4/Folder Down |
| ⑥ *Key #0/Preset #10 | ⑯ Preset #1/Repeat |
| ⑦ Volume Down | ⑰ Mode/Search/Shift |
| ⑧ Preset #3/Intro | ⑱ Tune/Track Down |
| ⑨ Preset #2/Random | |
| ⑩ Preset #6/Menu | |



General Operation

Front Panel Note:	The front panel is semi-permanently attached during assembly. Please refer to the separate yellow instructions (before installation) to make the front panel removable.
Front Panel Removal	With the unit off, press EJECT to allow the front panel to slide down. Gently squeeze the release tab located on the bottom center underside and pull front panel down and away from unit to remove. To install, insert left side first, then push right side to secure.
Power On/Off	Press PWR for 2 seconds or any other button momentarily to turn the unit on. Inserting a disc will turn the unit on automatically. Press PWR for 2 seconds to turn the unit off.
Mode	Press MODE to select between AM/FM, *XM Radio, CD player and auxiliary input. Modes of operation are indicated in the display. *Optional XM Satellite Radio Receiver and subscription required for XM Radio operation.
Volume	Adjust volume using rotary encoder (00-46).
Shift Function (XM Radio only)	Press SHIFT for 2 seconds to activate the SHIFT function. The SHIFT icon will appear in the display. In XM Radio mode, the SHIFT function must be active to access the EQ function. Press SHIFT again for 2 seconds to cancel.
Preset EQ Curves	Press EQ to select between POP, JAZZ, CLASSIC, BEAT, ROCK and OFF (default) equalization curves. Any adjustment to the Bass or Treble settings automatically cancels the current EQ curve (if one is selected).
Display	When in AM/FM, CD or AUX mode: Press DISP to select between clock and radio frequency (tuner mode), clock and CD elapsed time/track (CD mode), or clock and AUX (AUX mode). When in XM Radio mode: Press DISP to select between channel name, artist name, song title or clock.
Set the Clock	With the unit on, press and hold DISP until the clock begins to flash, then release. Press TUNE ◀◀ to adjust the hours and TUNE ▶▶ to adjust the minutes. Press DISP momentarily to save the selected time.

General Operation - Setup Menu

12/24-hour Clock The clock will display 12-hour AM/PM time in USA frequency spacing mode (PM 10:00). In European frequency spacing mode, the clock will display 24-hour time (22:00).

Setup Menu Press and hold the **rotary encoder** for more than 3 seconds to access the setup menu. Press the **rotary encoder** momentarily to select between the menu functions and rotate the **rotary encoder** left/right to adjust or activate the desired function.

Menu Function	Options	Action
Loudness Curve	LOUD OFF	Disables the loudness function.
	LOUD ON	Enables the loudness function. Activating this feature will enhance the bass and treble frequencies when listening to music at low volumes.
Clock Display Priority	FUNC PRI	Radio frequency (tuner mode), XM information (XM mode), CD elapsed time/track or MP3/WMA file information (CD mode) or AUX (AUX mode) will be displayed by default. Clock is accessed by pressing DISP momentarily.
	CLK PRI	Clock will be displayed by default. Radio frequency (tuner mode), XM information (XM mode), CD elapsed time/track or MP3/WMA file information (CD mode) is accessed by pressing DISP momentarily.
Tuner Frequency Spacing	FREQ USA	Programs the unit to USA tuner spacing. (200kHz for FM and 10kHz for AM)
	FREQ EUR	Programs the unit to European tuner spacing. (50kHz for FM and 9kHz for AM)
Clock Display	CLK OFF	Programs the unit to not display the clock when the power is off.
	CLK ON	Programs the unit to display the clock when the power is off.
Auxiliary Mode	AUX ON	Enables access to auxiliary mode.
	AUX OFF	Disables access to auxiliary mode.
Beep Confirmation	BEEP OFF	Disables the confirmation beep.
	BEEP ON	Enables the confirmation beep.
Local/Distance Tuning	LOC OFF	Activates Distance tuning.
	LOC ON	Activates Local tuning for strong station reception only.



General Operation

Audio	<p>Press rotary encoder momentarily to select between Volume (default), Bass, Treble, Balance, & Fader.</p> <p>➤VOLUME →BASS→TREBLE→BALANCE→FADER</p>
Bass	<p>Press rotary encoder until BAS appears then rotate encoder left/right to adjust (-6 minimum / +6 maximum).</p>
Treble	<p>Press rotary encoder until TRE appears then rotate encoder left/right to adjust (-6 minimum / +6 maximum).</p>
Balance	<p>Press rotary encoder until BAL appears then rotate encoder left/right to adjust (BAL L 12-BAL 00-BAL R 12). BAL 00 represents equal balance</p>
Fader	<p>Press rotary encoder until FAD appears then rotate encoder left/right to adjust (FAD F 12-FAD 00-FAD R 12). FAD 00 represents equal fader</p>
Source Audio Memory	<p>Individual Bass and Treble settings are retained in memory for AM, FM, CD, XM, and AUX modes. This allows you to save the Bass and Treble settings separately for each mode.</p> <p>Note: Any adjustment to the Bass or Treble settings automatically cancels the current EQ curve (if one is selected).</p>
Reset	<p>Press RESET upon initial installation or if abnormal operation occurs. The reset button is located behind the faceplate.</p>
Record	<p>This feature is available when used with the EAUSB20 Media Link Adapter (sold separately).</p>
Menu	<p>This feature is available when used with the EAUSB20 Media Link Adapter (sold separately).</p>
Return	<p>This feature is available when used with the EAUSB20 Media Link Adapter (sold separately).</p>

AM/FM Tuner Operation

Seek Tuning	Press TUNE ◀◀ or TUNE ▶▶ momentarily to seek the next strong station.
Manual Tuning	Press TUNE ◀◀ or TUNE ▶▶ for more than 2 seconds, then release. "MANUAL" will momentarily appear in the display. Press TUNE ◀◀ or TUNE ▶▶ momentarily to move radio frequency up or down one step at a time. Press and hold to advance quickly. If tuning is not adjusted for 5 seconds, the unit will return to seek tuning mode (default). "AUTO" will momentarily appear in the display.
Scan Tuning	Press SCN to preview strong stations on the current band, pausing for 5 seconds at each. Press SCN again to cancel.
Band	Press BAND to select between FM1, FM2, FM3, AM1 and AM2 bands.
Storing and Recalling Station Presets	Up to 18 FM stations and 12 AM stations can be stored. To store a station, select the desired band and station. Press and hold the desired preset button (1-6) for more than 2 seconds. When stored, the preset number will appear in the display. The station can be recalled anytime by pressing the corresponding preset button.
	<p>Note: Function keys 7, 8, 9 and 0 apply to XM Radio and MP3/WMA operation only.</p>
Automatically Store Stations	Press AS/PS for more than 2 seconds to automatically store the six strongest stations in the current band. Automatic Local tuning is activated during the initial band scan.
Preset Scan	Press AS/PS for less than 2 seconds to scan presets 1-6 on the current band, pausing for 5 seconds at each. Press AS/PS again to cancel.



XM Radio Activation

Activating Your XM Receiver (when connected)

1. Press **MODE** to select XM Radio.
2. Verify channel 1 (XM Preview Channel) is playing.
3. Select Channel 0. The XM receiver's eight character Radio ID number will appear on the XDMR6850 display.
The Radio ID number is also located on the XM receiver unit (sold separately).
4. Record the number here for future reference:

□	□	□	□	□	□	□	□
---	---	---	---	---	---	---	---

5. Activate your XM Satellite Radio service.
To subscribe, log onto <http://www.xmradio.com/activation> or call 1-800-967-2346.

Note:





You will need to keep your XDMR6850 turned on for at least one hour after requesting activation to receive the full channel line-up.

XM Radio Operation





Tuning Modes	Press BAND to select between XM DIRECT, XM1 and XM2 bands.
Basic Channel Selection	Press TUNE ◀◀ or TUNE ▶▶ momentarily to select the next available channel. Press and hold to advance quickly.
Direct Channel Selection	Press BAND to select XM DIRECT channel entry band. "DIRECT" will momentarily appear in the display. Enter the desired channel using buttons 1-0, then press FUNC for 3 seconds to confirm the selected channel. If the channel is not available, the current channel will be retained.
Category Recall	Press FUNC once to display the category of the currently selected channel for 2 seconds. The CATEGORY icon will appear on the display.

XM Radio Operation

Channel Search by Category

Press **FUNC** once, the **CATEGORY** icon will appear on the display. Press  or  to choose a different category, then press **TUNE**  or **TUNE**  to choose a channel within that category. Press **FUNC** for 3 seconds to select the desired channel. If you do not select a channel, the channel search will time out after several seconds and the current channel will be retained.

Channel Search by Name

Press **FUNC** twice, the **SEARCH** icon will appear on the display. Use the rotary encoder to select the desired alphanumeric channel name. Press  to enter each character or  to clear the entry. Press **FUNC** for more than 3 seconds to begin the channel name search. Press **TUNE**  or **TUNE**  to review the channel search results. Press **FUNC** for 3 seconds to select the desired channel. If you do not select a channel, the channel search will time out after several seconds and the current channel will be retained. If the search results are not valid, "NOTFOUND" will momentarily appear on the display and current channel will be retained.

Storing and Recalling Preset Channels

Up to 20 XM channels can be stored. To store a channel, select XM1 or XM2 band and the desired channel. Press and hold the desired preset button (1-0) for more than 2 seconds. When stored, the preset number will momentarily appear in the display. The channel can be recalled anytime by pressing the corresponding preset button.

Note:

Presets 7, 8, 9 and 0 apply to XM Radio operation only.

Display Options

Press **DISP** to select between the following display options:

 Channel Name  Artist Name  Song title  Clock

The selected display option will be retained in memory (when changing channels for instance).

Text Scrolling

Press **SCROLL** for more than 3 seconds to activate continuous text scrolling. The current channel name, artist name or song title will scroll continuously (if more than 8 characters). Press **SCROLL** for more than 3 seconds again to cancel continuous text scrolling.



CD Player Operation

Insert CD	With the label facing up, insert a standard size CD into the CD slot. The CD will automatically begin playback.
Eject CD	Press EJECT to eject the CD. The unit will change to previous mode of operation (AM, FM, XM, or auxiliary input). If the disc is not removed within 10 seconds, the unit will reload the disc. The unit does not have to be turned on to eject CD.
Track Select	Press TRACK ▶▶ to skip to the beginning of the next track. Press TRACK ◀◀ to return to the beginning of the current track. Pressing TRACK ◀◀ again skips to the beginning of the previous track.
Fast Forward and Reverse	Press and hold TRACK ▶▶ or TRACK ◀◀ to fast forward or reverse a track.
Pause	Press ▶/ to temporarily stop CD playback. Press ▶/ again to resume playback.
Scan	Press INT to play the first 10 seconds of each track. Press INT again to cancel.
Repeat	Press RPT to continuously repeat selected track. Press RPT again to cancel.
Random	Press RDM to play all tracks in random order. Press RDM again to cancel. Random mode is retained in memory when selecting between AM/FM tuner, XM Radio, CD player and auxiliary input modes and when the unit is turned on/off.
CD-R/CD-RW Compatibility	<p>Some CD-Rs and CD-RWs may be incompatible with this unit, depending on media type and recording method. In addition, the following CDs may be incompatible with this unit:</p> <p>CDs exposed to extreme temperatures or direct sunlight for extended periods of time, CDs recorded in which a recording session failed or a re-recording was attempted and, or encrypted or copy-protected CDs which do not conform to the audio CD-DA red book recording standard.</p>

CD Player Operation - MP3/WMA Files

Playing an MP3/WMA Disc

When an MP3/WMA encoded disc is first inserted, "READING" will appear in the display. Depending on the number of files and folders, this may take several seconds.

MP3 Icon

The  icon will illuminate anytime a valid MP3 encoded disc is inserted and flash in MP3 search/navigate modes.

WMA Icon

The  icon will illuminate anytime a valid WMA encoded disc is inserted and flash in WMA search/navigate modes.

Folder Icon

The  icon will illuminate anytime a folder is selected in the file/folder search modes.

Displaying Information

Press **DISP** to select between track number/elapsed time (default), clock, track name, directory name, title, artist, album, year and comment.

"NO ID3 TAG" will be displayed if the MP3 file contains no ID3 tag information.

"UNKNOWN" will be displayed if the WMA file contains no WMA tag information.

"ROOT" will be displayed if the directory name of a root folder is not labeled.

Character Support

Maximum character display information

- Track name – 32 character maximum
- Directory name – 32 character maximum
- *Song title – 30 character maximum
- *Artist name – 30 character maximum
- *Album name – 30 character maximum
- *Year – 4 character maximum
- *Comment – 28 character maximum

*Song title, Artist Name, Album name, Year and Comment will only be displayed if included with the MP3/WMA file.

When referring to MP3/WMA playback, the following terms are synonymous:

- File name and track name
- Folder name and directory name

CD Player Operation - MP3/WMA Files

Refer to the following button function table when selecting, searching or navigating MP3/WMA files and folders:

MP3/WMA Button Function Table	
Button	Function
SRCH	Direct Select, Search and Navigate Modes
	Enter/Confirm
Preset #1	A, B, C, 1
Preset #2	D, E, F, 2
Preset #3	G, H, I, 3
Preset #4	J, K, L, 4
Preset #5	M, N, O, 5
Preset #6	P, Q, R, 6
Key #7	S, T, U, 7
Key #8	V, W, X, 8
Key #9	Y, Z, /, 9
Key #0	-, _, +, 0
Rotary Encoder (push)	Character Shift
Rotary Encoder (rotate)	Character Select (A, B, C ~ 8, 9, 0)

Direct Select, Search and Navigate Modes

Press **SRCH** for more than 3 seconds, to select between the following modes:

- Direct File Select
- Alphanumeric File or Folder Search
- File or Folder Navigate

Direct File Select Step 1

Press **SRCH** for more than 3 seconds, then release. "MP3 T*" or "WMA T*" will flash in the display. Use the buttons in the above table (3 keystroke maximum input), or the rotary encoder to enter the desired file number.

Step 2

Press  to confirm the selected file number or wait for the input cycle to time out (approximately 5 seconds). If the file is not available, "NO FILE" will be displayed momentarily and the current file will continue to play.

CD Player Operation - MP3/WMA Files

Alphanumeric File or Folder Search

Step 1

Press **SRCH** for more than 3 seconds, then release. Press **SRCH** again, an "*" will flash in the display. Use the buttons in the table on page 14 (32 character maximum input) or the rotary encoder to enter the desired alphanumeric search characters. Press the **rotary encoder** to advance one character to the right.

Step 2

Press  to initiate the selected alphanumeric search.

Step 3

Turn the rotary encoder to preview the search results. If the search returns a folder, the  icon will illuminate.

Step 4

Press  to select the desired file or folder. If a folder is selected, "/" will be displayed. Turn the rotary encoder to the right to begin searching files in the folder.

Step 5

Press  to select the desired file within the folder.

Note:

If the file is not available, "NO FILE" will be displayed momentarily and the current file will continue to play.

File/Folder Navigate

Step 1

Press **SRCH** for more than 3 seconds, then release. Press **SRCH** again two times to navigate files/folders on the disc. The current folder name will scroll one time followed by available files and folders.

Step 2

Turn the rotary encoder to preview files/folders in the current folder. If a folder is selected, the  icon will illuminate.

Step 3

Press  to select the desired file or folder. If a folder is selected, "/" will be displayed. Turn the rotary encoder to the right to begin searching files in the folder.

Step 4





Press  to select the desired file within the folder.

*Folder Access (Up one level)

When navigating folders (and "/" is displayed), press the **rotary encoder** to access the previous level (up one level).
*Only available on MP3/WMA discs recorded with more than one folder.



CD Player Operation - MP3/WMA Files

Navigating Note	After navigating by direct select, alphanumeric search or file/folder navigate modes, the track number and elapsed time will be displayed by default. Press DISP momentarily to select clock, track name, directory name, title, artist, album, year or comment.
*Folder Access	Press  to select the previous folder. Press  to select the next folder. *Folder access is only available on MP3/WMA discs recorded with more than one folder.
File Repeat	Press RPT momentarily to continuously repeat selected file. Press RPT again to cancel.
File Repeat (Current Folder Only)	Press RPT for more than 2 seconds to consecutively repeat all files in the current folder only. The  icon will appear in the display when in folder repeat mode. Press RPT again to cancel.
Disc Random	Press RDM momentarily to play all files on entire disc in random order. Press RDM again to cancel.
Folder Random	Press RDM for more than 2 seconds to play all files in current folder only in random order. The  icon will appear in the display when in folder random mode. Press RDM again to cancel.
Disc Intro	Press INT momentarily to play the first 10 seconds of each file on the entire MP3/WMA disc. Press INT again to cancel.
Folder Intro	Press INT for more than 2 seconds to play the first 10 seconds of each file in the current folder only. The  icon will appear in the display when in folder intro mode. Press INT again to cancel.
	Note: File repeat (current folder only), folder random and folder intro is only available on MP3/WMA discs recorded with more than one folder.

CD Player Operation - MP3/WMA Files

Media Compatibility

The following types of discs/files are compatible:

- CD-ROM (ISO), CD-R, CD-RW
- CD-DA
- MP3 data
- WMA data

The following types of discs/files are not compatible:

- WMA files that are protected by DRM (Digital Rights Management).
- WMA lossless format
- Discs recorded with Track At Once or packet writing
- MP3 PRO format
- MP3 playlists
- WAV format

Playback Order

MP3/WMA playback sequence is based on recorded order of files and begins in the root folder of the disc. Any empty folders or folders that do not include MP3/WMA files are skipped. This unit may not play files in the order they were recorded in. Refer to your recording software's user's manual for more information.

Compatible Recording Formats

- ISO9660 level 1
- ISO9660 level 2
- Yellow Book MODE 1
- Yellow Book MODE 2 FORM 1
- Multi session
- Maximum folders and files - 256
- Maximum folder levels - 8
- MPEG-1/2/2.5 Audio Layer-3

ISO9660 standards:

- Maximum nested folder depth is 8 (including the root folder).
- Valid characters for folder/file names are letters A-Z (all caps), numbers 0-9, and "_" (underscore). Some characters may not be displayed correctly, depending on the character type.
- This device can play back discs in Joliet, Romeo, and other standards that conform to ISO9660. MP3/WMA written in the formats other than the above may not play and/or their file names or folder names may not be displayed properly.



CD Player Operation - MP3/WMA Files

Additional MP3/WMA Information	<p>An internal buffer provides ESP (Electronic Skip Protection) to virtually eliminate skipping.</p> <p>When playing a disc recorded with regular audio files (CD-DA or .WAV) and MP3/WMA files, the unit will play the MP3/WMA files only.</p> <p>Only MP3 files with filename extension (.mp3) can be played. Only WMA files with filename extension (.wma) can be played.</p> <p>Do not attempt to play discs which contain non-MP3/WMA files with the MP3/WMA extension.</p>
Sampling Frequency Rates	
MP3	8kHz ~ 48kHz
WMA	32kHz ~ 48kHz
Transfer Bit rates	
MP3	8kbps ~ 320kbps constant Variable bit rates
WMA	32kbps ~ 192kbps constant Variable bit rates
	<p>Note: Some files may not play or be displayed correctly, depending on sampling rates and bit rates.</p>
MP3 Tag Display	<p>ID3 tags Version 1.x This model will not display ID3 Version 2.0 or greater tags.</p>
Recommended Settings	<p>For best results, use the following settings when burning an MP3 disc: 128kbps or higher constant bit rate 44.1kHz or higher sampling frequency</p> <p>For best results, use the following settings when burning a WMA disc: 64kbps or higher constant bit rate 32kHz or higher sampling frequency</p>

Limited One Year Warranty

This warranty gives you specific legal rights. You may also have other rights which vary from state to state.

Dual Electronics Corp. warrants this product to the original purchaser to be free from defects in material and workmanship for a period of one year from the date of the original purchase.

Dual Electronics Corp. agrees, at our option, during the warranty period, to repair any defect in material or workmanship or to furnish an equal new, renewed or comparable product (whichever is deemed necessary) in exchange without charges, subject to verification of the defect or malfunction and proof of the date of purchase. Subsequent replacement products are warranted for the balance of the original warranty period.

Who is covered? This warranty is extended to the original retail purchaser for products purchased and used in the U.S.A.

What is covered? This warranty covers all defects in material and workmanship in this product. The following are not covered: installation/removal costs, damage resulting from accident, misuse, abuse, neglect, product modification, improper installation, incorrect line voltage, unauthorized repair or failure to follow instructions supplied with the product, or damage occurring during return shipment of the product.

What to do?

1. Before you call for service, check the troubleshooting guide in your owner's manual. A slight adjustment of any custom controls may save you a service call.
2. If you require service during the warranty period, you must carefully pack the product (preferably in the original package) and ship it by prepaid transportation with a copy of the original receipt from the retailer to an authorized service center.
3. Please describe your problem in writing and include your name, a return UPS shipping address (P.O. Box not acceptable), and a daytime phone number with your shipment.
4. For more information and for the location of the nearest authorized service center please contact us by one of the following methods:

- Call us toll-free at 1-866-382-5476
- E-mail us at cs@dualav.com

Exclusion of Certain Damages: This warranty is exclusive and in lieu of any and all other warranties, expressed or implied, including without limitation the implied warranties of merchantability and fitness for a particular purpose and any obligation, liability, right, claim or remedy in contract or tort, whether or not arising from the company's negligence, actual or imputed. No person or representative is authorized to assume for the company any other liability in connection with the sale of this product. In no event shall the company be liable for indirect, incidental or consequential damages.



Specifications

CD Player	Frequency response: 10Hz-20kHz Channel separation @ 1kHz: >65dB D/A converter: 1 Bit
FM Tuner	Tuning range: 87.5MHz-107.9MHz Usable sensitivity: 8.5dBf 50dB quieting sensitivity: 10dBf Stereo separation @ 1kHz: 40dB Frequency response: 30Hz-13kHz
AM Tuner	Tuning range: 530kHz-1710kHz Usable sensitivity: 22uV Frequency response: 30Hz-2.2kHz
General	Operating voltage: 11-16 VDC, negative ground Speaker output impedance: 4~8 ohms Line output voltage: 2 Volts Dimensions: 7" x 7" x 2" (178 x 178 x 51 mm)

Design and specifications subject to change without notice.



CEA-2006 Power Standard Specifications (reference: 14.4VDC +/- 0.2V, 20Hz~20kHz)

Power Output: 17 Watts RMS x 4 channels at 4 ohms and $\leq 1\%$ THD+N
Signal to Noise Ratio: 80dBA (reference: 1 watt into 4 ohms)

Troubleshooting - General

Problem	Cause	Action
Unit will not turn on (no power)	Yellow wire not connected or incorrect voltage Red wire not connected or incorrect voltage	Check connections for proper voltage (11~16VDC)
	Black wire not connected	Check connection to ground
	Fuse blown	Replace fuse
Unit has power (but no sound)	Speaker wires not connected	Check connections at speakers
	One or more speaker wires touching each other or touching chassis ground	Insulate all bare speaker wires from each other and chassis ground
Unit blows fuses	Yellow or red wire touching chassis ground	Check for pinched wire
	Speaker wires touching chassis ground	Check for pinched wire
	Incorrect fuse rating	Use fuse with correct rating
Excessive skipping	Unit is not mounted correctly or backstrap is not secure	Check mounting sleeve and backstrap support
	Physical defect in media (CD, CD-R or CD-RW)	Check media for scratches
ERROR-01 appears on display	Disc read error	Press eject or RESET
ERROR-02 appears on display	Focus error or disc is in upside down	Press eject or RESET
ERROR-03 appears on display	FAT error	Press eject or RESET
ERROR-04 appears on display	MP3/WMA decode error	Press eject or RESET
PROTECT appears on display	The WMA file is copy-protected by DRM (Digital Rights Management)	Write disc using WMA files that are not copy-protected
NO FILE appears on display	Selected file is not available in direct or alphanumeric search modes	Repeat search using valid parameters
INVALID appears on display	The file format is incompatible	Write disc using valid audio files with .mp3 or .wma file extensions
Unit will not accept a disc	CD mechanism position out of alignment	Press and hold DISP and TUNE ►► for 3 seconds to reset CD mechanism position
	CD transit screws still in place	Remove 2 transit screws located on top of the unit



Troubleshooting - XM Radio

Problem	Cause	Action
You can not receive any XM channels	Your XM Radio receiver is not activated	Contact XM as described on page 10
You can not tune into a specific XM channel	You may not be authorized to receive that channel	Verify your subscription with XM Contact XM as described on page 10
NO SIGNL appears on display	The XM signal is blocked	Move vehicle from obstructed area (such as inside a tunnel or a garage)
	This message may appear when driving inside a tunnel or under obstacles	Make sure the antenna has a clear view of the sky
ANTENNA appears on display	The XM antenna is not connected	Check XM antenna connection
	The antenna cable is damaged	Check for pinched or cut antenna cable
OFF AIR appears on display	The selected channel is not in service	Try another channel
No song title or artist name is displayed	This information may not be available for some music channels, news channels, or when there is no song playing	This condition is normal, there is nothing wrong with your receiver





Dual Electronics Corp.
Toll Free: 1-866-382-5476

www.dualav.com

©2006 Dual Electronics Corp. All rights reserved.

Windows Media and the Windows logo are trademarks, or registered trademarks of Microsoft Corporation in the United States and or other countries. The XM name and related logos are trademarks of XM Satellite Radio Inc.
NSA0906-V02

Free Manuals Download Website

<http://myh66.com>

<http://usermanuals.us>

<http://www.somanuals.com>

<http://www.4manuals.cc>

<http://www.manual-lib.com>

<http://www.404manual.com>

<http://www.luxmanual.com>

<http://aubethermostatmanual.com>

Golf course search by state

<http://golfingnear.com>

Email search by domain

<http://emailbydomain.com>

Auto manuals search

<http://auto.somanuals.com>

TV manuals search

<http://tv.somanuals.com>