



XHD6425

INSTALLATION/OWNER'S MANUAL

AM/FM/CD/MP3/WMA/USB/3.5mm Bluetooth® Ready Receiver
with Built-In HD Radio™ and Detachable Face



Bluetooth®
READY

HD Radio®



Preparation

Please read entire manual before installation.

Before You Start

- Disconnect negative battery terminal. Consult a qualified technician for instructions.
- Avoid installing the unit where it would be subject to high temperatures, such as from direct sunlight, or where it would be subject to dust, dirt or excessive vibration.

Getting Started

- Remove trim ring from unit.
- Remove 2 transit screws located on top of the unit.
- Insert the supplied keys into the slots as shown, and slide the unit out of the mounting sleeve.
- Install mounting sleeve into opening, bending tabs to secure.
- Connect wiring harness and antenna. Consult a qualified technician if you are unsure.
- Certain vehicles may require an installation kit and/or wiring harness adapter (sold separately).
- Test for correct operation and slide unit into mounting sleeve to secure.
- Snap trim ring into place.

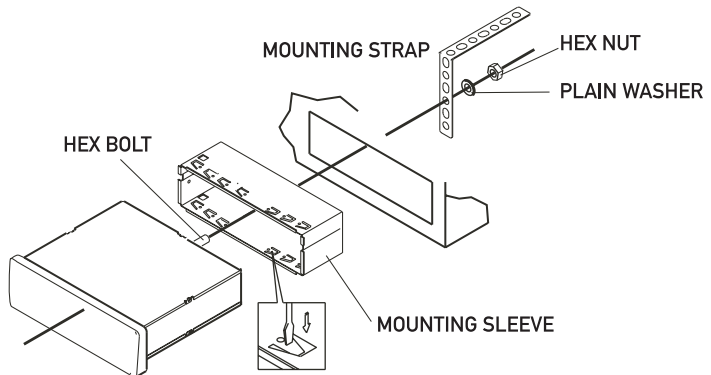
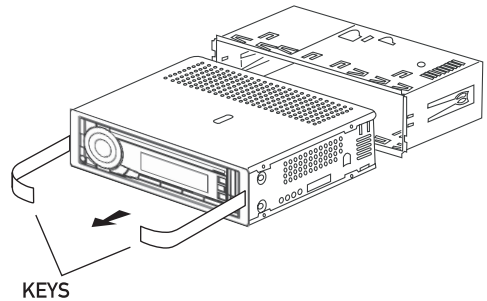

TYPICAL FRONT-LOAD DIN MOUNTING METHOD

Wiring Diagram

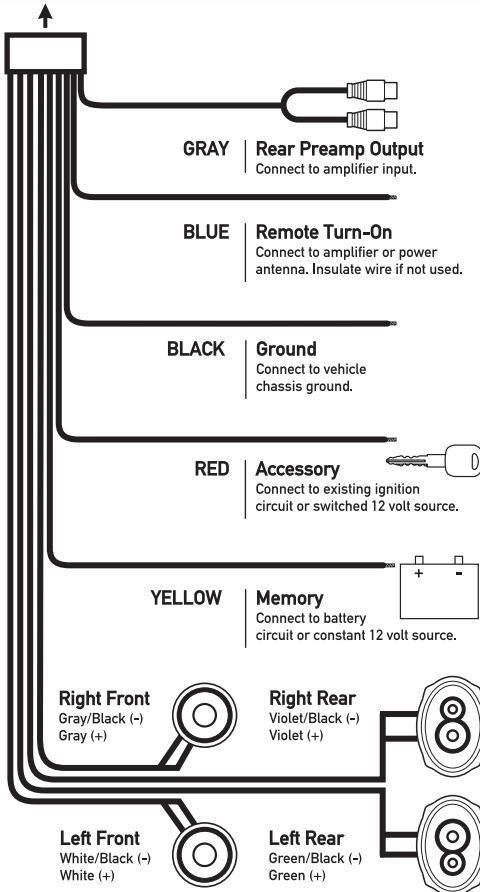
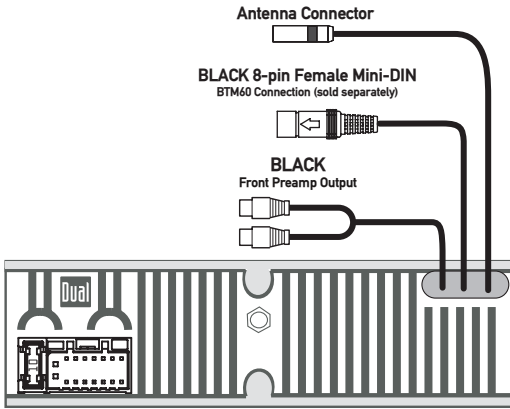

FUSE

When replacing the fuse, make sure new fuse is the correct type and amperage. Using an incorrect fuse could damage the radio. The XHD6425 uses one 10 amp ATM fuse located beside the wiring connector.

Control Locations - Receiver

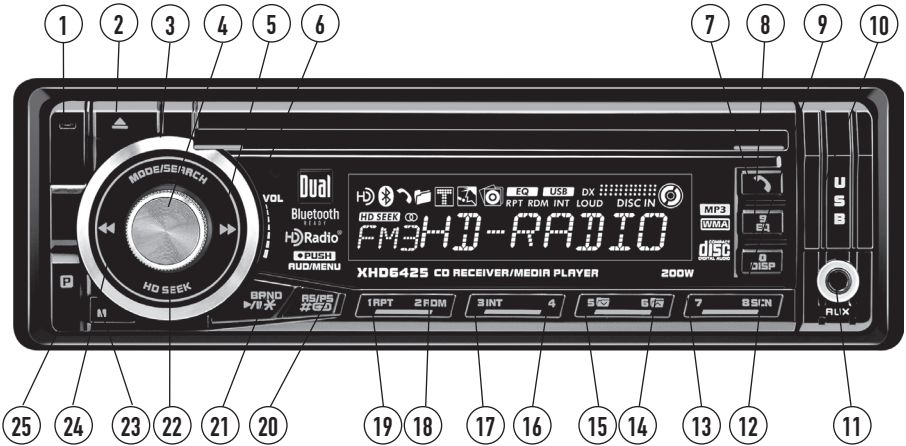

- | | |
|----------------------|----------------------------------|
| ① Release | ⑭ Preset 6/Folder Up |
| ② Eject | ⑮ Preset 5/Folder Down |
| ③ Mode/Search | ⑯ Preset 4 |
| ④ Volume/Audio/Setup | ⑰ Preset 3/Intro |
| ⑤ Tune/Track Up | ⑱ Preset 2/Random |
| ⑥ IR Remote Sensor | ⑲ Preset 1/Repeat |
| ⑦ Talk/Redial | ⑳ Auto Store/Prescan/Enter/Key # |
| ⑧ EQ/Key 9 | ㉑ Band/Play/Pause/Key * |
| ⑨ Display/Key 0 | ㉒ HD Seek |
| ⑩ USB Port (Covered) | ㉓ Mute/End Call |
| ⑪ Auxiliary Input | ㉔ Tune/Track Down |
| ⑫ Tuner Scan/Key 8 | ㉕ Power |
| ⑬ Key 7 | |

The XHD6425 allows playback of your favorite MP3 and WMA files recorded on CD-R and CD-RW discs. Its powerful on-board DSP processor decodes the compressed audio while maintaining near-CD sound quality. An internal SRAM buffer provides ESP (Electronic Skip Protection) to virtually eliminate skipping and allows alphanumeric or direct track search - even while a song is currently playing!

Function keys 7, 8, 9 and 0 apply to Bluetooth, USB and MP3/WMA operation only.

Control Locations - Remote

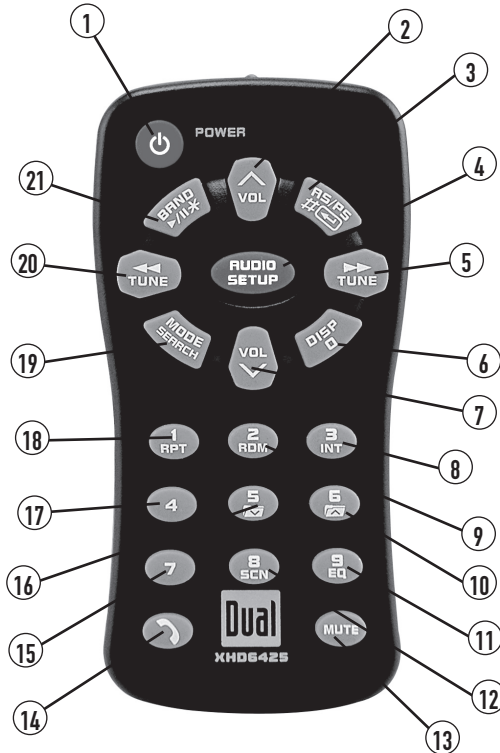

- | | |
|----------------------|-------------------------|
| ① Power | ⑪ Key 9/EQ |
| ② Volume Up | ⑫ Key 8/Scan |
| ③ AS/PS/Enter/Key # | ⑬ Mute |
| ④ Audio/Setup | ⑭ Talk/Redial |
| ⑤ Tune/Track Up | ⑮ Key 7 |
| ⑥ Display/Key 0 | ⑯ Preset 5/Folder Down |
| ⑦ Volume Down | ⑰ Preset 4 |
| ⑧ Preset 3/Intro | ⑱ Preset 1/Repeat |
| ⑨ Preset 2/Random | ⑲ Mode/Search |
| ⑩ Preset 6/Folder Up | ⑳ Tune/Track Down |
| | ㉑ Band/Play/Pause/Key * |



General Operation

Faceplate Removal	Press RELEASE and pull away from the left side to remove. To re-install, insert right side of faceplate first then push left side to secure.
Semi-Permanent Faceplate Installation	Remove trim ring and install supplied #1 x 7/32" Phillips head screw through left side of mounting frame into faceplate.
Power On/Off	Press POWER or any other button (except eject) to turn the unit on. Inserting a disc will turn the unit on automatically. Press POWER to turn the unit off.
Mode	Press MODE to select between AM/FM, CD player, USB, auxiliary input and Bluetooth (optional). Modes of operation are indicated in the display. NOTE: CD and Bluetooth modes will not appear unless a CD is inserted or BTM60 (Bluetooth module - sold separately) is attached.
Auxiliary Input	Insert 3.5 mm plug to connect your portable audio device.
Volume	Adjust volume using rotary encoder (00-46).
Programmable Turn-On Volume	Press and hold POWER for 3 seconds to program currently selected volume level. "P-VOL" and the current volume level will momentarily appear in the display.
Mute	Press MUTE to silence the audio. "MUTE" will flash in the display. Press MUTE again to cancel.
Preset EQ Curves	Press EQ to select between POP, JAZZ, CLASSIC, BEAT, ROCK and OFF (default) equalization curves. Any adjustment to the Bass or Treble settings automatically cancels the current EQ curve (if one is selected).
Reset	Press to RESET the unit upon initial installation or if abnormal operation occurs. The reset button is located behind the faceplate.
Display	Press DISP to select between clock and different types of information, such as radio frequency, HD Radio song information, CD track/elapsed time, or MP3/WMA/USB song information.

General Operation

Set the Clock	With the unit on, press and hold DISP until the clock begins to flash, then release. Press TUNE ◀◀ to adjust the hours and TUNE ▶▶ to adjust the minutes. Press DISP momentarily to save the selected time.
Setup Menu	Press and hold the rotary encoder for more than 3 seconds to access the setup menu. Press the rotary encoder momentarily to select between the menu functions and rotate the rotary encoder left/right to adjust or activate the desired function.

Setup Menu

Menu Function	Options	Action
Loudness Curve	LOUD OFF	Disables the loudness function.
	LOUD ON	Enables the loudness function. Activating this feature will enhance the bass and treble frequencies when listening to music at low volumes.
Clock Display	CLK OFF	Programs the unit to not display the clock when the power is off.
	CLK ON	Programs the unit to display the clock when the power is off.
Auxiliary Input	AUX ON	Enables the front panel 3.5mm auxiliary input.
	AUX OFF	Disables the auxiliary input.
Beep Confirmation	BEEP OFF	Disables the confirmation beep.
	BEEP ON	Enables the confirmation beep.
Local/Distance Tuning	LOC OFF	Activates distance tuning.
	LOC ON	Activates local tuning for strong station reception only.
Power on Message	MSG OFF	Disables power on message.
	MSG ON	Enables power on message to be displayed.
Demonstration Mode	DEMO OFF	Disables the demonstration mode.
	DEMO ON	Enables the "BUILT IN HD RADIO AND BT READY" message.
Display Scrolling	SCRL ON	Programs the unit to scroll display information continuously.
	SCRL OFF	Disables the display scroll feature.



General Operation

Audio Press **rotary encoder** momentarily to select between Volume (default), Bass, Treble, Balance, & Fader.

→VOLUME →BASS→TREBLE→BALANCE→FADER

Bass Press **rotary encoder** until **BAS** appears then rotate encoder left/right to adjust (-6 minimum / +6 maximum).

Treble Press **rotary encoder** until **TRE** appears then rotate encoder left/right to adjust (-6 minimum / +6 maximum).

Balance Press **rotary encoder** until **BAL** appears then rotate encoder left/right to adjust (BAL L 12-BAL 00-BAL R 12).
BAL 00 represents equal balance

Fader Press **rotary encoder** until **FAD** appears then rotate encoder left/right to adjust (FAD F 12-FAD 00-FAD R 12).
FAD 00 represents equal fader

Source Audio Memory Individual Bass and Treble settings are retained in memory for AM, FM, CD, AUX, USB and Bluetooth modes. This allows you to save the Bass and Treble settings separately for each mode.

Note:

Any adjustment to the Bass or Treble settings automatically cancels the current EQ curve (if one is selected).

HD Radio™ AM/FM Tuner Operation

Analog and Digital Tuning	The following tuning functions will access both analog and digital stations. Refer to the HD SEEK mode section on page 10 for instructions on tuning to only digital stations.
Seek Tuning	<p>Press TUNE ◀◀ or TUNE ▶▶ momentarily to seek the next strong station.</p> <p>When an HD Radio station is selected, an HD Radio logo will begin to flash on the display. In about five seconds, HD or HD1 will illuminate after the radio frequency.</p> <ul style="list-style-type: none"> • If "HD" appears, the radio station is broadcasting a higher quality sound. No additional stations are available. • If "HD1" appears, additional multicast channels (HD2 and/or HD3) are available. Press TUNE ◀◀ or TUNE ▶▶ to tune to other available multicast channels.
Manual Tuning	Press TUNE ◀◀ or TUNE ▶▶ for more than two seconds, then release. "MANUAL" will momentarily appear in the display. Press TUNE ◀◀ or TUNE ▶▶ momentarily to move radio frequency up or down one step at a time. Press and hold to advance quickly. If tuning is not adjusted for five seconds, the unit will return to seek tuning mode (default). "AUTO" will momentarily appear in the display.
Scan Tuning	Press SCN to preview strong stations on the current band, pausing for five seconds at each. Press SCN again to cancel.
Storing and Recalling Station Presets	<p>Up to 18 FM stations and 12 AM stations can be stored, including HD Radio stations. To store a station, first select the desired band and station. Press and hold the desired preset button (1-6) for more than two seconds. When stored, the preset number appears in the display. The station can be recalled by pressing the corresponding preset button.</p> <p>Note: Function keys 7, 8, 9 and 0 apply to MP3/WMA, USB and Bluetooth operation only.</p>



HD Radio™ AM/FM Tuner Operation

Automatically Store Stations

Press **AS/PS** for more than two seconds to automatically store the six strongest stations in the current band. Automatic local tuning is activated during initial band scan.

Preset Scan

Press **AS/PS** momentarily to scan presets 1-6 on the current band, pausing for five seconds at each. Press **AS/PS** again to cancel.

Band

Press **BAND** to select FM1, FM2, FM3, AM1 or AM2.

Display

When the unit is tuned to an analog station, press **DISP** to toggle the display between the following options:



When the unit is tuned to an HD Radio station, press **DISP** to toggle the display between the following options:



When information is unavailable, "NO DATA" appears in the display.

HD Seek Mode

Press **HD SEEK** to activate digital-only tuning mode. The **HD SEEK** icon will appear on the display, indicating that the unit will skip over analog stations and tune to HD Radio stations only. Follow the instructions on page 9 to access seek, manual and scan tuning.

• Storing and Recalling Station Presets

HD Radio multicast stations (HD2 and HD3) can also be stored as presets. When a preset multicast station is recalled, "LINKING" appears in the display until the download process is complete (approximately 5 seconds).

Note: If the HD radio signal on the preset is unavailable, the unit reverts to the previous analog or digital station.

• Automatically Store Stations

While in **HD SEEK** mode, press **AS/PS** to automatically store HD Radio stations to presets 1-6. Multicast channels (HD2 and/or) HD3 are not stored but can be accessed by pressing **TUNE** ►► from the HD1 station.

CD Player Operation

Insert CD	With the label facing up, insert a standard size CD into the CD slot. The CD will automatically begin playback.
Eject CD	Press EJECT to eject the CD. The unit will change to previous mode of operation (tuner, AUX, USB or Bluetooth). If the disc is not removed within 10 seconds, the unit will reload the disc. The unit does not have to be turned on to eject CD.
Track Select	Press TRACK ►► to skip to the beginning of the next track. Press TRACK ◄◄ to return to the beginning of the current track. Pressing TRACK ◄◄ again skips to the beginning of the previous track.
Fast Forward and Reverse	Press and hold TRACK ►► or TRACK ◄◄ to fast forward or reverse a track.
Pause	Press ►/ to temporarily stop CD playback. Press ►/ again to resume playback.
Scan	Press INT to play the first 10 seconds of each track. Press INT again to cancel.
Repeat	Press RPT to continuously repeat selected track. Press RPT again to cancel.
Random	Press RDM to play all tracks in random order. Press RDM again to cancel. Random mode is retained in memory when selecting between AM, FM, CD, AUX, USB and Bluetooth modes and when the unit is turned on/off.
CD-R/CD-RW Compatibility	<p>Some CD-Rs and CD-RWs may be incompatible with this unit, depending on media type and recording method. In addition, the following CDs may be incompatible with this unit:</p> <p>CDs exposed to extreme temperatures or direct sunlight for extended periods of time, CDs recorded in which a recording session failed or a re-recording was attempted and, or encrypted or copy-protected CDs which do not conform to the audio CD-DA red book recording standard.</p>

CD Player Operation - MP3/WMA Files

Playing an MP3/WMA Disc

When an MP3/WMA encoded disc is first inserted, "READING" will appear in the display. Depending on the number of files and folders, this may take several seconds.

Displaying Information

Press **DISP** to select between track number/elapsed time (default), clock, track name, directory name, title, artist and album.

"NO ID3 TAG" will be displayed if the MP3 file contains no ID3 tag information.

"UNKNOWN" will be displayed if the WMA file contains no WMA tag information.

"ROOT" will be displayed if the directory name of a root folder is not labeled.

Title Icon 

This icon will illuminate when the song title is displayed.

Artist Icon 

This icon will illuminate when the artist name is displayed.

Album Icon 

This icon will illuminate when the album name is displayed.

Folder Icon 

This icon will illuminate when the folder name is displayed.

Character Support

Maximum character display information

- Track name – 32 character maximum
- Directory name – 23 character maximum
- *Song title – 30 character maximum
- *Artist name – 30 character maximum
- *Album name – 30 character maximum

*Song title, Artist Name and Album name will only be displayed if included with the MP3/WMA file.

When referring to MP3/WMA playback, the following terms are synonymous:

- File name and track name
- Folder name and directory name

CD Player Operation - MP3/WMA Files

Refer to the following button function table when selecting, searching or navigating MP3/WMA files and folders:

MP3/WMA Button Function Table	
Button	Function
SEARCH	Direct Select, Search and Navigate Modes
	Enter/Confirm
Preset #1	A, B, C, 1
Preset #2	D, E, F, 2
Preset #3	G, H, I, 3
Preset #4	J, K, L, 4
Preset #5	M, N, O, 5
Preset #6	P, Q, R, 6
Key #7	S, T, U, 7
Key #8	V, W, X, 8
Key #9	Y, Z, /, 9
Key #0	-, _, +, 0
Rotary Encoder (push)	Character Shift
Rotary Encoder (rotate)	Character Select (A, B, C ~ 8, 9, 0)
MUTE	Character Backspace

Direct Select, Search and Navigate Modes

Press **SEARCH** for more than 3 seconds, to select between the following modes:

- Direct File Select
- Alphanumeric File or Folder Search
- File or Folder Navigate

Direct File Select Step 1

Press **SEARCH** for more than 3 seconds, then release. "MP3 T*" or "WMA T*" will flash in the display. Use the buttons in the above table (3 keystroke maximum input), or the rotary encoder to enter the desired file number.

Step 2

Press  to confirm the selected file number or wait for the input cycle to time out (approximately 5 seconds). If the file is not available, "NO FILE" will be displayed momentarily and the current file will continue to play.

CD Player Operation - MP3/WMA Files

Alphanumeric File or Folder Search

Step 1

Press **SEARCH** for more than 3 seconds, then release. Press **SEARCH** again, an "*" will flash in the display. Use the buttons in the table on page 12 (32 character maximum input) or the rotary encoder to enter the desired alphanumeric search characters. Press the rotary encoder to advance one character to the right.

Step 2

Press  to initiate the selected alphanumeric search.

Step 3

Turn the rotary encoder to preview the search results. If the search returns a folder, the  icon will illuminate.

Step 4

Press  to select the desired file or folder. If a folder is selected, "/" will be displayed. Turn the rotary encoder to the right to begin searching files in the folder.

Step 5

Press  to select the desired file within the folder.

Note:

If the file is not available, "NO FILE" will be displayed momentarily and the current file will continue to play.

File/Folder Navigate

Press **SEARCH** for more than 3 seconds, then release.

Step 1

Press **SEARCH** again two times to navigate files/folders on the disc. The current folder name will scroll one time followed by available files and folders.

Step 2

Turn the rotary encoder to preview files/folders in the current folder. If a folder is selected, the  icon will illuminate.

Step 3

Press  to select the desired file or folder. If a folder is selected, "/" will be displayed. Turn the rotary encoder to the right to begin searching files in the folder.

Step 4





Press  to select the desired file within the folder.

*Folder Access (Up one level)

When navigating folders (and "/" is displayed), press **MUTE** to access the previous level (up one level).

*Only available on MP3/WMA discs recorded with more than one folder.

CD Player Operation - MP3/WMA Files

Navigating Note	After navigating by direct select, alphanumeric search or file/folder navigate modes, the track number and elapsed time will be displayed by default. Press DISP momentarily to select clock, track name, directory name, title, artist and album.
*Folder Access	Press  to select the previous folder. Press  to select the next folder. *Folder access is only available on MP3/WMA discs recorded with more than one folder.
File Repeat	Press RPT momentarily to continuously repeat selected file. Press RPT again to cancel.
File Repeat (Current Folder Only)	Press RPT for more than 2 seconds to consecutively repeat all files in the current folder only. The  icon will appear in the display when in folder repeat mode. Press RPT again to cancel.
Disc Random	Press RDM momentarily to play all files on entire disc in random order. Press RDM again to cancel.
Folder Random	Press RDM for more than 2 seconds to play all files in current folder only in random order. The  icon will appear in the display when in folder random mode. Press RDM again to cancel.
Disc Intro	Press INT momentarily to play the first 10 seconds of each file on the entire MP3/WMA disc. Press INT again to cancel.
Folder Intro	Press INT for more than 2 seconds to play the first 10 seconds of each file in the current folder only. The  icon will appear in the display when in folder intro mode. Press INT again to cancel.
	Note: File repeat (current folder only), folder random and folder intro is only available on MP3/WMA discs recorded with more than one folder.



CD Player Operation - MP3/WMA Files

Media Compatibility

The following types of discs/files are compatible:

- CD-ROM (ISO), CD-R, CD-RW
- CD-DA
- MP3 data
- WMA data

The following types of discs/files are not compatible:

- WMA files that are protected by DRM (Digital Rights Management).
- WMA lossless format
- Discs recorded with Track At Once or packet writing
- MP3 PRO format
- MP3 playlists
- WAV format

Playback Order

MP3/WMA playback sequence is based on recorded order of files and begins in the root folder of the disc. Any empty folders or folders that do not include MP3/WMA files are skipped. This unit may not play files in the order they were recorded in. Refer to your recording software's user's manual for more information.

Compatible Recording Formats

- ISO9660 level 1
- ISO9660 level 2
- Yellow Book MODE 1
- Yellow Book MODE 2 FORM 1
- Multi session
- Maximum folders and files - 256
- Maximum folder levels - 8
- MPEG-1/2/2.5 Audio Layer-3

ISO9660 standards:

- Maximum nested folder depth is 8 (including the root folder).
- Valid characters for folder/file names are letters A-Z (all caps), numbers 0-9, and “_” (underscore). Some characters may not be displayed correctly, depending on the character type.
- This device can play back discs in Joliet, Romeo, and other standards that conform to ISO9660. MP3/WMA written in the formats other than the above may not play and/or their file names or folder names may not be displayed properly.

CD Player Operation - MP3/WMA Files

Additional MP3/WMA Information	<p>An internal buffer provides ESP (Electronic Skip Protection) to virtually eliminate skipping.</p> <p>When playing a disc recorded with regular audio files (CD-DA or .WAV) and MP3/WMA files, the unit will play the MP3/WMA files only.</p> <p>Only MP3 files with filename extension (.mp3) can be played. Only WMA files with filename extension (.wma) can be played.</p> <p>Do not attempt to play discs which contain non-MP3/WMA files with the MP3/WMA extension.</p>
Sampling Frequency Rates	<p>MP3 8kHz ~ 48kHz</p> <p>WMA 32kHz ~ 48kHz</p>
Transfer Bit rates	<p>MP3 32kbps ~ 320kbps constant Variable bit rates</p> <p>WMA 32kbps ~ 192kbps constant Variable bit rates</p> <p>Note: Some files may not play or be displayed correctly, depending on sampling rates and bit rates.</p>
MP3 Tag Display	<p>ID3 tags Version 1.x This model will not display ID3 Version 2.0 or greater tags.</p>
Recommended Settings	<p>For best results, use the following settings when burning an MP3 disc: 128kbps or higher constant bit rate 44.1kHz or higher sampling frequency</p> <p>For best results, use the following settings when burning a WMA disc: 64kbps or higher constant bit rate 32kHz or higher sampling frequency</p>

USB Operation - MP3/WMA Files (Optional)

Connecting a USB Device (sold separately)

Play MP3/WMA files from most mass storage devices by connecting them to the XHD6425's USB port. To connect a USB device, lift the protective cover to expose the USB port. Line up the connectors, and insert the USB device into the port. The USB icon will appear in the display.

Playing Music

When a USB device is first connected, press **MODE** to access USB mode. "READING" will appear momentarily in the display. Depending on the number of files and folders, this may take several seconds. If no valid MP3/WMA files are detected, "NO FILE" will be displayed and the last mode will be resumed.

Displaying Information

Press **DISP** to select between elapsed time (default), track number, clock, track name, directory name, title, artist and album.

"NO TITLE" will be displayed if no song title information is available.

"NO ARTIST" will be displayed if no artist information is available.

"NO ALBUM" will be displayed if no album information is available.

Title Icon

This icon will illuminate when the song title is displayed.

Artist Icon

This icon will illuminate when the artist name is displayed.

Album Icon

This icon will illuminate when the album name is displayed.

Folder Icon

This icon will illuminate when the folder name is displayed.







Character Support

Maximum character display information

- Track name – 32 character maximum
- Directory name – 32 character maximum
- *Song title – 32 character maximum
- *Artist name – 32 character maximum
- *Album name – 32 character maximum

*Song title, artist name and album name will only be displayed if included with the MP3/WMA file.

USB Operation - MP3/WMA Files (Optional)

File Navigation	Press SEARCH for more than three seconds, then release. "T*" will appear in the display. Use the rotary encoder to select the desired track number and press  to confirm.
Direct File Select	Press SEARCH for more than three seconds, then release. "T*" will appear in the display. Use the number buttons (0-9) or the rotary encoder to enter the desired file number. Press  to confirm or wait for the input cycle to time out (approximately five seconds). If the file is not available, "NO FILE" will be displayed momentarily and the current file will continue to play.
*Folder Access	Note: When a file is accessed, the elapsed time will be displayed. Press DISP momentarily to select track number, clock, track name, directory name, title, artist or album. Press  to select the previous folder. Press  to select the next folder. *Folder access is only available on USB devices with more than one folder.
File Repeat	Press RPT momentarily to continuously repeat selected file. Press RPT again to cancel.
File Repeat (Current Folder Only)	Press RPT for more than two seconds to consecutively repeat all files in the current folder only. The  icon will appear in the display. Press RPT again to cancel.
Random	Press RDM momentarily to play all files on entire USB device in random order. Press RDM again to cancel.
Folder Random	Press and hold RDM for more than 2 seconds to play all files in current folder only in random order. The  icon will appear in the display. Press RDM again to cancel.
Intro	Press INT momentarily to play the first 10 seconds of each file on the entire USB device. Press INT again to cancel.





USB Operation - MP3/WMA Files (Optional)

Folder Intro

Press **INT** for more than two seconds to play the first 10 seconds of each file in the current folder only. The  icon will appear in the display. Press **INT** again to cancel.

Note: File repeat (current folder only), folder random and folder intro are only available on USB devices with more than one folder.



Track Select

Press **TRACK**  to skip to the beginning of the next track. Press **TRACK**  to return to the beginning of the current track. Pressing **TRACK**  again skips to the beginning of the previous track.

Fast Forward and Reverse

Press and hold **TRACK**  or **TRACK**  to fast forward or reverse a track.

Pause

Press  to temporarily stop USB playback. Press  again to resume playback.

Media Compatibility

The following types of files are compatible:

- MP3 data
- WMA data

The following types of files are not compatible:

- WMA files that are protected by DRM (Digital Rights Management).
- WMA lossless format
- MP3 PRO format
- MP3 playlists
- WAV format

Playback Order

MP3/WMA playback sequence is based on the order in which the files are copied to the USB device and begins in the root folder. Any empty folders or folders that do not include MP3/WMA files are skipped. Depending on your software, the playback order may vary.

USB Operation - MP3/WMA Files (Optional)

Playback Capacity

- Maximum number of files: 48896
- Maximum number of folders: 127 plus the root directory
- Maximum number of files in each folder and root: 382
- Maximum number of folder levels (sub folders): 8
(7 levels plus the root)

Note: If the number of files/folders exceeds the maximum outlined above, the additional files/folders will be ignored.

Additional MP3/WMA Information

Only MP3 files with filename extension (.mp3) can be played. Only WMA files with filename extension (.wma) can be played. Do not attempt to play non-MP3/WMA files with the MP3/WMA extension.

Sampling Frequency

Rates

MP3

8kHz ~ 48kHz

WMA

32kHz ~ 48kHz

Transfer Bit rates

MP3

32kbps ~ 320kbps constant
Variable bit rates

WMA

32kbps ~ 192kbps constant
Variable bit rates

Note:

Some files may not play or be displayed correctly, depending on sampling rates and bit rates.

MP3 Tag Display

ID3 tags Version 1.x

This model will not display ID3 Version 2.0 or greater tags.

Note: If an invalid ID3 tag version is detected, "NO SUPPORT" will scroll on the display.

USB Charging

Charge a cell phone, portable MP3 player or other device through the unit's USB port.

Note: The unit does not need to be in USB mode in order to charge; it can charge from any mode.



Bluetooth® Operation (Optional)

Overview

Connecting a Bluetooth device requires first connecting the **Dual BTM60** module (sold separately). When connected to a Dual Bluetooth Ready head unit, the BTM60 supports the HFP (hands-free profile), A2DP (advanced audio distribution profile) and AVRCP (audio video remote control profile).

Preparation

Before you can use a mobile device with this head unit, it must be connected and authenticated - commonly referred to as "pairing" a device. Please make sure that Bluetooth is activated on your mobile device before you begin the pairing process. Refer to the owner's manual of your mobile device for more details.

Bluetooth Pairing

- 1) To pair a Bluetooth enabled mobile phone to your head unit, press **↶** on the head unit or BTM60, or press **MODE** until "DUAL_BT60" is displayed.
- 2) Press and hold **↶** on the head unit or the BTM60 for 5 seconds, until "PAIRING" is displayed, the Bluetooth icon will flash every second. The head unit will begin to broadcast a signal for 60 seconds.
- 3) Complete the pairing from the Bluetooth menu of your mobile device by searching for new devices. Please refer to your mobile device instructions for further information on Bluetooth pairing and connections. The Bluetooth icon will illuminate solid.

The BTM60 device name is "DUAL_BT60."

The password for the DUAL BT60 is 1234.

Connection Notes

- If **ACNT** is set to **OFF**, you must press **↶** to connect after pairing.
- From Bluetooth standby mode, press **MUTE** to disconnect your mobile device from the BTM60.
- From Bluetooth standby mode, press **↶** to reconnect your mobile device to the BTM60.
- To connect a different mobile device, the currently connected mobile device must be disconnected. If this device has been paired previously, you may reconnect using the mobile device's Bluetooth menu, or repeat the above pairing instructions.

General Notes



- Due to the differences in Bluetooth technology, some mobile devices may be incompatible or function improperly when used with the BTM60.
- The BTM60 will store the last eight (8) devices that have been paired in its memory. If more than eight devices are paired, the head unit will remove the oldest device from its memory and that device will have to be paired again.

Bluetooth® Operation (Optional)

Function	Description
Making a Phone Call	Press ↵ once. An "_" will appear on the display.
	Input the desired phone number using the 0-9, *, # buttons on the head unit front panel. Press ↵ to begin dialing.
	A phone call may also be placed from your mobile device using the keypad, phone book or speed dial.
Last Number Dialing	To enter last number dialing mode, press ↵ , then press ↵ a second time. The head unit will display "Last Number Dialing."
	Press KEY 0 to cycle through the received, dialed or missed call categories. Rotate the rotary encoder to cycle through the last 5 calls in the selected category. Note: You have 8 seconds to make a choice before the head unit returns to Bluetooth standby mode.
	Press ↵ to begin dialing the selected number.
Receiving a Phone Call	If an incoming call is detected, the head unit will automatically switch to Bluetooth mode, muting any current audio.
	The incoming phone number will appear on the display, the phone icon will flash on the display, and a ring tone will be audible from the vehicle speakers. See Bluetooth Settings for speaker configurations.
	NOTE: The ring audio level will depend the mobile device and head unit ring volume and audio settings. If the ringer on the mobile device is off, you may not hear an incoming ring tone.
	Press ↵ on the head unit or BTM60 to receive a call. The phone icon will illuminate solid.
Refusing a Call	To refuse an incoming phone call, press and hold MUTE for 3 seconds.
During a Phone Call	The head unit will display the elapsed time of the phone call.
	The rotary encoder will adjust the volume of the call.
	Press MUTE to select between microphone on (MIC ON) and microphone off (MIC OFF).
Audio Transfer	To transfer the phone call between the head unit and the mobile device, press and hold DISP for 3 seconds during a call. Tip: transfer audio to your mobile device before turning the head unit off.
Call Waiting	When a second call is incoming, press ↵ to activate call waiting. The current call will be placed on hold, and the second call will be active. Press ↵ again to return to the first call.
Ending a Phone Call	Hold MUTE for 3 or more seconds to end a call.
	If the phone call was received, the head unit will return to previous mode when call is ended.



Bluetooth® Settings (Optional)

Menu Function	Options	Action
Bluetooth Mode	BT ON	Enables the BTM60 Bluetooth Interface Module (sold separately). The Bluetooth icon will flash every 10 seconds.
	BT OFF	Disables Bluetooth support.
Auto Connect	ACNT ON	Allows the BTM60 to automatically (re)connect to the most recently connected mobile device. Note: Some mobile devices do not support this feature.
	ACNT OFF	Disables the auto connect feature. You must press  every time to connect a mobile device.
Auto Answer	AANS OFF	Disables the auto answer feature. Press  to receive an incoming call.
	AANS ON	All incoming calls will be answered automatically - without notification.
Bluetooth Audio	SPK 2-CH	Directs the Bluetooth audio to the front speakers.
	SPK 4-CH	Directs the Bluetooth audio to all 4 speakers.



Bluetooth Streaming Audio Operation (AV MODE)

The BTM60 supports A2DP wireless streaming audio from your Bluetooth mobile device directly to your head unit. You can also control your music from the front panel of the head unit using AVRCP.

To stream music to your head unit, your mobile device must support the following criteria:

- A2DP profile to stream audio
- AVRCP profile to control your music. Check the owner's manual or manufacturer of your device for compatibility.
- Streaming audio must be enabled from your mobile device. This option will vary depending on the device. Example: "Set as wireless stereo."
- Disabling AV MODE must be done from your mobile device.

After enabling streaming audio from a compatible mobile device, the head unit will display "AV MODE." The following functions can be used to control music:

- The  button will skip to the next available audio track.
- The  button will skip to the previous audio track.
- The  button will toggle between play and pause during playback.
- The **MUTE** button will stop the audio playback.

NOTE: If you are experiencing problems with these functions, try playing music from the mobile device. On some mobile devices, it may be necessary to control the music from the device.

Limited One Year Warranty

This warranty gives you specific legal rights. You may also have other rights which vary from state to state.

Dual Electronics Corp. warrants this product to the original purchaser to be free from defects in material and workmanship for a period of one year from the date of the original purchase.

Dual Electronics Corp. agrees, at our option, during the warranty period, to repair any defect in material or workmanship or to furnish an equal new, renewed or comparable product (whichever is deemed necessary) in exchange without charges, subject to verification of the defect or malfunction and proof of the date of purchase. Subsequent replacement products are warranted for the balance of the original warranty period.

Who is covered? This warranty is extended to the original retail purchaser for products purchased and used in the U.S.A.

What is covered? This warranty covers all defects in material and workmanship in this product. The following are not covered: installation/removal costs, damage resulting from accident, misuse, abuse, neglect, product modification, improper installation, incorrect line voltage, unauthorized repair or failure to follow instructions supplied with the product, or damage occurring during return shipment of the product.

What to do?

1. Before you call for service, check the troubleshooting guide in your owner's manual. A slight adjustment of any custom controls may save you a service call.
2. If you require service during the warranty period, you must carefully pack the product (preferably in the original package) and ship it by prepaid transportation with a copy of the original receipt from the retailer to an authorized service center.
3. Please describe your problem in writing and include your name, a return UPS shipping address (P.O. Box not acceptable), and a daytime phone number with your shipment.
4. For more information and for the location of the nearest authorized service center please contact us by one of the following methods:
 - Call us toll-free at 1-866-382-5476
 - E-mail us at cs@dualav.com

Exclusion of Certain Damages: This warranty is exclusive and in lieu of any and all other warranties, expressed or implied, including without limitation the implied warranties of merchantability and fitness for a particular purpose and any obligation, liability, right, claim or remedy in contract or tort, whether or not arising from the company's negligence, actual or imputed. No person or representative is authorized to assume for the company any other liability in connection with the sale of this product. In no event shall the company be liable for indirect, incidental or consequential damages.

Troubleshooting - General

Problem	Cause	Action
Unit will not turn on (no power)	Yellow wire not connected or incorrect voltage	Check connections for proper voltage (11~16VDC)
	Red wire not connected or incorrect voltage	
	Black wire not connected	Check connection to ground
	Fuse blown	Replace fuse
Unit has power (but no sound)	Speaker wires not connected	Check connections at speakers
	One or more speaker wires touching each other or touching chassis ground	Insulate all bare speaker wires from each other and chassis ground
Unit blows fuses	Yellow or red wire touching chassis ground	Check for pinched wire
	Speaker wires touching chassis ground	Check for pinched wire
	Incorrect fuse rating	Use fuse with correct rating
Excessive skipping	Unit is not mounted correctly or backstrap is not secure	Check mounting sleeve and backstrap support
	Physical defect in media (CD, CD-R or CD-RW)	Check media for scratches
ERROR-01 appears on display	Disc read error	Press EJECT or RESET
ERROR-02 appears on display	Focus error or disc is in upside down	Press EJECT or RESET
PROTECT appears on display	The WMA file is copy-protected by DRM (Digital Rights Management)	Write disc using WMA files that are not copy-protected
NO FILE appears on display	Selected file is not available in direct or alphanumeric search modes	Repeat search using valid parameters
INVALID appears on display	The file format is incompatible	Write disc using valid audio files with .mp3 or .wma file extensions
Unit will not accept a disc	CD mechanism position out of alignment	Press and hold EJECT for 3 seconds to reset CD mechanism position
	CD transit screws still in place	Remove 2 transit screws located on top of the unit
PAIRING FAILED appears on the display	Pairing attempt has exceeded 60 seconds	Retry pairing sequence. Pairing must complete within 60 seconds
	Phone is not setup correctly to connect to a bluetooth hands free device	Check the owners manual for instructions on enabling bluetooth
	Bluetooth device is not compatible with the BTM60	Call 1-866-382-5476 for the latest compatibility information
BTM60 reset	Reset the BTM60 to clear the memory of previously paired mobile devices and to clear recent dialed/missed/received phone calls from memory	From Bluetooth standby mode, press and hold MODE for BTM60 reset.
NO SUPPORT appears on display	An invalid ID3 tag version is present	Version 1.x ID3 tags are supported. Version 2.0 or greater are not supported

Specifications

CD Player	<p>Frequency response: 10Hz-20kHz Channel separation @ 1kHz: >65dB D/A converter: 1 Bit</p>
FM Tuner	<p>Tuning range: 87.5MHz-108.1MHz Usable sensitivity: 8.5dBf 50dB quieting sensitivity: 10dBf Stereo separation @ 1kHz: 40dB HD radio stereo separation @ 1kHz: 85dB Frequency response: 30Hz-13kHz HD radio frequency response: 30Hz-20kHz</p>
AM Tuner	<p>Tuning range: 530kHz-1710kHz Usable sensitivity: 22uV Frequency response: 240~3KHz HD radio frequency response: 30~4.4KHz HD radio stereo separation @ 1kHz: 85dB</p>
USB	<p>Operating voltage: 5 Volts DC Supplied current: 500mA</p>
General	<p>Operating voltage: 11-16 VDC, negative ground Speaker output impedance: 4~8 ohms Line output voltage: 2 Volts Dimensions: 7" x 7" x 2" (178 x 178 x 51 mm)</p>

Design and specifications subject to change without notice.



CEA-2006 Power Standard Specifications (reference: 14.4VDC +/- 0.2V, 20Hz~20kHz)

Power Output: 17 Watts RMS x 4 channels at 4 ohms and \leq 1% THD+N
 Signal to Noise Ratio: 80dBA (reference: 1 watt into 4 ohms)



Dual Electronics Corp.
Toll Free: 1-866-382-5476

www.dualav.com
©2007 Dual Electronics Corp. All rights reserved.

Windows Media and the Windows logo are trademarks, or registered trademarks of Microsoft Corporation in the United States and or other countries.

The Bluetooth® word mark and logos are owned by the Bluetooth SIG, Inc. and any use of such marks by Movon is under license.

HD Radio™ Technology Manufactured Under License from iBiquity Digital Corporation. U.S. and Foreign Patents. HD Radio™ and the HD Radio logo are proprietary trademarks of iBiquity Digital Corp.

Other trademarks and trade names are those of their respective owners.

NSA0807-V02

Free Manuals Download Website

<http://myh66.com>

<http://usermanuals.us>

<http://www.somanuals.com>

<http://www.4manuals.cc>

<http://www.manual-lib.com>

<http://www.404manual.com>

<http://www.luxmanual.com>

<http://aubethermostatmanual.com>

Golf course search by state

<http://golfingnear.com>

Email search by domain

<http://emailbydomain.com>

Auto manuals search

<http://auto.somanuals.com>

TV manuals search

<http://tv.somanuals.com>