



# XR4110

## INSTALLATION/OWNER'S MANUAL

AM/FM/MP3/WMA Receiver with Auxiliary Input,  
USB Port and SD Card Input



**USB**

**AUX**

Front Panel Input



## Preparation

Please read entire manual before installation.

### Before You Start

- Disconnect negative battery terminal. Consult a qualified technician for instructions.
- Avoid installing the unit where it would be subject to high temperatures, such as from direct sunlight, or where it would be subject to dust, dirt or excessive vibration.

### Getting Started

- Insert the supplied keys into the slots as shown, and slide the unit out of the mounting sleeve.
- Install mounting sleeve into opening, bending tabs to secure.
- Connect wiring harness and antenna. Consult a qualified technician if you are unsure.
- Certain vehicles may require an installation kit and/or wiring harness adapter (sold separately).
- Test for correct operation and slide into the mounting sleeve to secure.
- Snap trim ring into place.

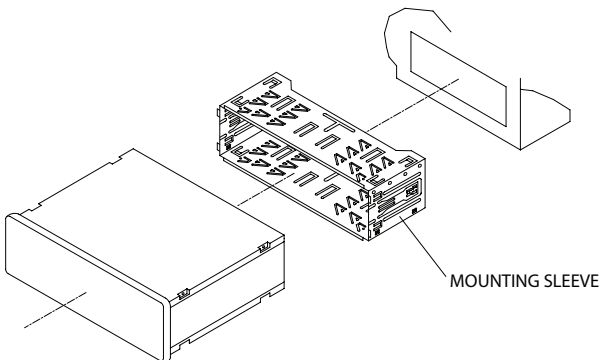
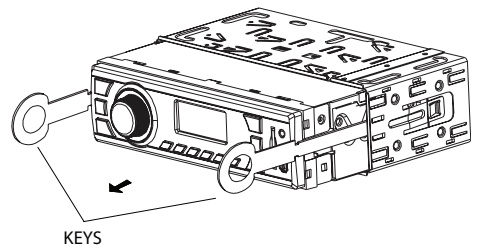

### TYPICAL MOUNTING METHOD

# Wiring Diagram

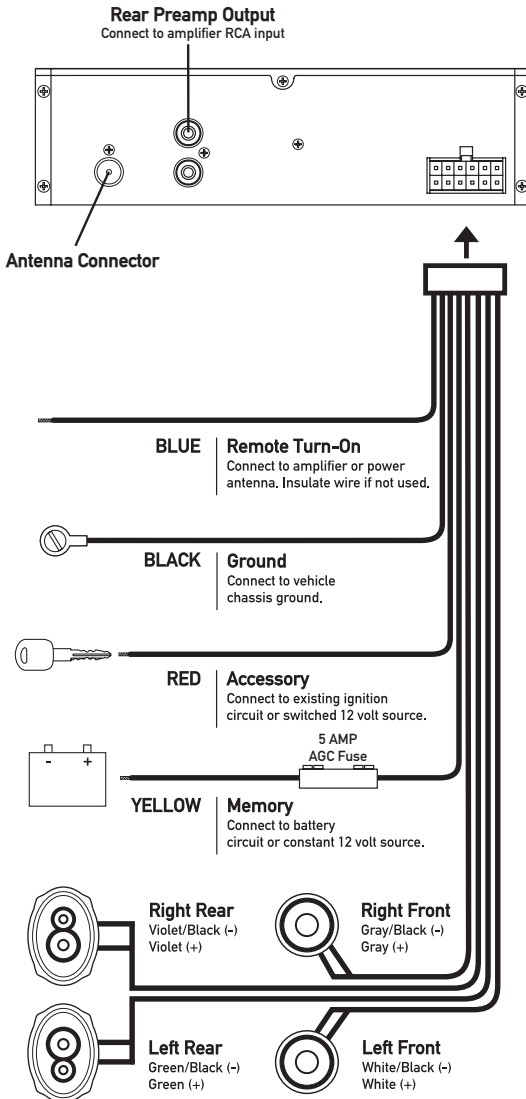

**FUSE**

When replacing the fuse, make sure new fuse is the correct type and amperage. Using an incorrect fuse could damage the radio. The XR4110 uses one 5 amp AGC fuse located in-line.



**\* Caution - Do not attach any speaker leads to ground as severe damage will occur.**

# Control Locations



- |                             |                           |
|-----------------------------|---------------------------|
| ① Power / Source            | ⑨ Tune / Track Down       |
| ② Mute / Loud               | ⑩ Preset 6                |
| ③ Volume                    | ⑪ Preset 5 / Folder Up    |
| ④ Tune / Track Up           | ⑫ Preset 4 / Folder Down  |
| ⑤ Band / Auto Station Store | ⑬ Preset 3 / Play / Pause |
| ⑥ SD Card Slot              | ⑭ Preset 2 / Random       |
| ⑦ Auxiliary Input           | ⑮ Preset 1 / Repeat       |
| ⑧ USB Port                  | ⑯ Audio / EQ              |

## General Operation



<b>Power On/Off</b>	Press  to turn the unit on. Press and hold  for more than two seconds to turn the unit off.
<b>Source</b>	Press <b>SOURCE</b> to select between AM/FM, auxiliary input, USB or SD Card modes. Modes of operation are indicated in the display. SD and USB modes will not appear unless an SD Card or USB device is connected.
<b>Loud</b>	Press and hold <b>LOUD</b> for more than 2 seconds to activate and deactivate the loudness feature. Activating this feature will enhance the bass and treble frequencies when listening to music at low volumes.
<b>Auxiliary Input</b>	Insert a 3.5mm connector in the front panel AUX port. Connect the other end of the 3.5mm connector to the headphone output of an audio device, MP3 player, etc.
<b>Volume</b>	Adjust volume using the <b>volume knob</b> (00-42).
<b>Select Audio</b>	Press <b>AUDIO</b> to select between Bass, Treble, Balance and Fader.  <div style="border: 1px solid black; padding: 5px; width: fit-content; margin: 10px auto;">       → BASS → TREBLE → BALANCE → FADER →     </div>
<b>Bass</b>	Press <b>AUDIO</b> until <b>BASS</b> appears Rotate the <b>volume knob</b> left/right to adjust (-7 minimum / 7 maximum)
<b>Treble</b>	Press <b>AUDIO</b> until <b>TRE</b> appears Rotate the <b>volume knob</b> left/right to adjust (-7 minimum / 7 maximum)
<b>Balance</b>	Press <b>AUDIO</b> until <b>B 00</b> appears Rotate the <b>volume knob</b> left/right to adjust <b>BL 15</b> (left) to <b>BR 15</b> (right)
<b>Fader</b>	Press <b>AUDIO</b> until <b>F 00</b> appears Rotate the <b>volume knob</b> left/right to adjust <b>FR 15</b> (rear) to <b>FF 15</b> (front)
<b>Preset EQ Curves</b>	Press <b>EQ</b> for more than two seconds to activate the first preset EQ, then press and hold <b>EQ</b> again to select between POP, CLASSIC, ROCK and USER. Manual adjustments to the bass and treble settings are saved as USER.



## Tuner Operation

<b>Seek Tuning</b>	Press <b>TUNE</b> ◀◀ or <b>TUNE</b> ▶▶ for more than 2 seconds to seek the next strong station.
<b>Manual Tuning</b>	Press <b>TUNE</b> ◀◀ or <b>TUNE</b> ▶▶ momentarily to change one radio station at a time. Press and hold to advance quickly.
<b>Band</b>	Press <b>BAND</b> to select between FM1, FM2, FM3 and AM1, AM2 bands. Six presets can be saved in each band.
<b>Storing and Recalling Station Presets</b>	Up to 18 FM stations and 12 AM stations can be stored. To store a station, select the desired band and station. Press and hold the desired preset button for more than 2 seconds. When stored, the preset number will appear in the display. The station can be recalled anytime by pressing the corresponding preset button.
<b>Automatically Store Stations</b>	Press <b>AST</b> for more than 2 seconds to automatically store the six strongest stations in the current band.  After the six strongest stations are set, a scan of each stored preset will begin. Press <b>AST</b> or <b>TRACK</b> ▶▶ to cancel.

## USB/SD Card Operation

<b>Connecting a USB Device</b> (sold separately)	Play MP3/WMA files from many mass storage devices by connecting them to the XR4110's USB port.
<b>Inserting an SD Card</b> (sold separately)	To play MP3/WMA files from an SD card, insert an SD card into the XR4110's SD card slot with the label facing left. It will click into place when properly inserted. To remove the card, press in until it clicks, then pull to remove.
<b>Playing Music</b>	When a USB or SD card device is first connected, playback will begin automatically. Depending on the number of files and folders, the device may take several seconds to begin playback. If no valid MP3/WMA files are detected, "USB" or "SD" will continually be displayed.
<b>Track Select</b>	<p>Press <b>TRACK</b> ►► to skip to the beginning of the next track. Press <b>TRACK</b> ◄◄ to return to the beginning of the current track. Pressing <b>TRACK</b> ◄◄ again skips to the beginning of the previous track.</p> <p><b>Note:</b> Track numbers are specific to the current folder and will restart at 1 for each folder.</p>
<b>Fast Forward and Reverse</b>	Press and hold <b>TRACK</b> ►► or <b>TRACK</b> ◄◄ to fast forward or reverse a track.
<b>Pause</b>	Press ►/   to temporarily stop USB playback. Press ►/   again to resume playback.
<b>Folder Access</b>	<p>Press  to select the previous folder. Press  to select the next folder.</p> <p><b>Note:</b> Any files that are located on the root directory of the USB/SD card device will be accessed as folder 1 (F01).</p>
<b>Repeat</b>	Press <b>RPT</b> to continuously repeat the current track. Press <b>RPT</b> again to cancel.
<b>Random</b>	Press <b>RDM</b> to play all the tracks in the current folder in random order. Press <b>RDM</b> again to cancel.



## USB/SD Card Operation

### Media Compatibility

The following types of files are compatible:

- MP3 data
- WMA data

The following types of files are not compatible:

- WMA files that are protected by DRM (Digital Rights Management).
- WMA lossless format
- MP3 PRO format
- MP3 playlists
- WAV format

### Playback Order

MP3/WMA playback sequence is based on order the files are copied to the USB/SD card device and begins in the root folder. Any empty folders or folders that do not include MP3/WMA files are skipped. Depending on your software, the playback order may vary. Files in the root directory are located in Folder 1.

### Playback Capacity

- Maximum number of files: 65535
- Maximum number of folders: 65535
- Maximum number of files in each folder: 65535
- Maximum number of folder levels (sub folders): 7

**Note:** If the number of files/folders exceeds the maximum outlined above, the additional files/folders will be ignored.

### Device Compatibility

USB and SD card device capacity limit:  $\leq 16$  gigabytes. Any devices greater than 16 gigabytes are not compatible.

Due to the differences of USB and SD card devices, some devices may not be compatible. Devices must be 'mass storage class' and formatted to the FAT or FAT32 file system in order to ensure compatibility.

### Sampling Frequency Rates

#### MP3

8kHz ~ 48kHz

#### WMA

8kHz ~ 48kHz

### Transfer Bit Rates

#### MP3

32kbps ~ 320kbps constant  
Variable bit rates

#### WMA

32kbps ~ 384kbps constant  
Variable bit rates

**Note:** Some files may not play or be displayed correctly, depending on sampling rates and bit rates.



## Troubleshooting

Problem	Cause	Action
Unit will not turn on (no power)	Yellow wire not connected or incorrect voltage Red wire not connected or incorrect voltage	Check connections for proper voltage (11-16VDC)
	Black wire not connected	Check connection to ground
	Fuse blown	Replace fuse
Unit has power (but no sound)	Speaker wires not connected	Check connections at speakers
	One or more speaker wires touching each other or touching chassis ground	Insulate all bare speaker wires from each other and chassis ground
Unit blows fuses	Yellow or red wire touching chassis ground	Check for pinched wire
	Speaker wires touching chassis ground	Check for pinched wire
	Incorrect fuse rating	Use fuse with correct rating
"ER" appears on display	USB or SD card compatibility issue	Device capacity must be less than 16GB.
		File system is incompatible - it must be FAT or FAT32.

## Specifications

FM Tuner	Tuning range: 87.5MHz-107.9MHz Usable sensitivity: 10dBf 50dB quieting sensitivity: 25dBu Stereo separation @ 1kHz: 40dB Frequency response: 30Hz-18kHz
AM Tuner	Tuning range: 530kHz-1710kHz Usable sensitivity: 35dBu Frequency response: 80Hz-2kHz
General	Speaker output impedance: 4~8 ohms Line output voltage: 1.5 Volts RMS Fuse: 5 amp AGC Dimensions: 7" x 2" x 4.2" (178 x 50 x 107 mm)
	Design and specifications subject to change without notice.



### CEA-2006 Power Standard Specifications

(reference: 14.4VDC +/- 0.2V, 20Hz~20kHz)

Power Output: 5 Watts RMS x 4 channels at 4 ohms and  $\leq$  1% THD+N  
Signal to noise ratio: 60dBA (reference: 1 watt into 4 ohms)



## Limited One Year Warranty

This warranty gives you specific legal rights. You may also have other rights which vary from state to state.

Dual Electronics Corp. warrants this product to the original purchaser to be free from defects in material and workmanship for a period of one year from the date of the original purchase.

Dual Electronics Corp. agrees, at our option, during the warranty period, to repair any defect in material or workmanship or to furnish an equal new, renewed or comparable product (whichever is deemed necessary) in exchange without charges, subject to verification of the defect or malfunction and proof of the date of purchase. Subsequent replacement products are warranted for the balance of the original warranty period.

**Who is covered?** This warranty is extended to the original retail purchaser for products purchased and used in the U.S.A.

**What is covered?** This warranty covers all defects in material and workmanship in this product. The following are not covered: installation/removal costs, damage resulting from accident, misuse, abuse, neglect, product modification, improper installation, incorrect line voltage, unauthorized repair or failure to follow instructions supplied with the product, or damage occurring during return shipment of the product.

### What to do?

1. Before you call for service, check the troubleshooting guide in your owner's manual. A slight adjustment of any custom controls may save you a service call.
2. If you require service during the warranty period, you must carefully pack the product (preferably in the original package) and ship it by prepaid transportation with a copy of the original receipt from the retailer to an authorized service center.
3. Please describe your problem in writing and include your name, a return UPS shipping address (P.O. Box not acceptable), and a daytime phone number with your shipment.
4. For more information and for the location of the nearest authorized service center please contact us by one of the following methods:
  - Call us toll-free at 1-866-382-5476
  - E-mail us at [cs@dualav.com](mailto:cs@dualav.com)

**Exclusion of Certain Damages:** This warranty is exclusive and in lieu of any and all other warranties, expressed or implied, including without limitation the implied warranties of merchantability and fitness for a particular purpose and any obligation, liability, right, claim or remedy in contract or tort, whether or not arising from the company's negligence, actual or imputed. No person or representative is authorized to assume for the company any other liability in connection with the sale of this product. In no event shall the company be liable for indirect, incidental or consequential damages.

---

## FCC Compliance

This device complies with Part 15 of the FCC Rules. Operation is subject to the following two conditions:

- (1) this device may not cause harmful interference, and
- (2) this device must accept any interference received, including interference that may cause undesired operation.

**Warning:** Changes or modifications to this unit not expressly approved by the party responsible for compliance could void the user's authority to operate the equipment.

**Note:** This equipment has been tested and found to comply with the limits for a Class B digital device, pursuant to Part 15 of the FCC Rules. These limits are designed to provide reasonable protection against harmful interference in a residential installation. This equipment generates, uses and can radiate radio frequency energy and, if not installed and used in accordance with the instructions, may cause harmful interference to radio communications. However, there is no guarantee that interference will not occur in a particular installation. If this equipment does cause harmful interference to radio or television reception, which can be determined by turning the equipment off and on, the user is encouraged to try to correct the interference by one or more of the following measures:

- Reorient or relocate the receiving antenna.
- Increase the separation between the equipment and receiver.
- Connect the equipment into an outlet on a circuit different from that to which the receiver is connected.
- Consult the dealer or an experienced radio/TV technician for help.



Dual Electronics Corp.  
Toll Free: 1-866-382-5476

Windows Media and the Windows logo are trademarks, or registered trademarks of Microsoft Corporation in the United States and or other countries.

The SD logo is a trademark of the SD Card Association.

Other trademarks and trade names are those of their respective owners.

[www.dualav.com](http://www.dualav.com)  
©2009 Dual Electronics Corp. All rights reserved.  
NSA0809-V02

## Free Manuals Download Website

<http://myh66.com>

<http://usermanuals.us>

<http://www.somanuals.com>

<http://www.4manuals.cc>

<http://www.manual-lib.com>

<http://www.404manual.com>

<http://www.luxmanual.com>

<http://aubethermostatmanual.com>

Golf course search by state

<http://golfingnear.com>

Email search by domain

<http://emailbydomain.com>

Auto manuals search

<http://auto.somanuals.com>

TV manuals search

<http://tv.somanuals.com>