



XDVD8265

INSTALLATION/OWNER'S MANUAL DVD Multimedia Receiver with 6.5" Touch Screen Display



Safety Note:

The DVD video display of the in-dash unit will not operate while the vehicle is moving. This is a safety feature to prevent driver distraction. In-dash DVD video functions will only operate when vehicle is in Park and the parking brake is engaged. It is illegal in most states for the driver to view video while the vehicle is in motion.



Table of Contents

	Page
DVD Region Management	2
Safety Information/Precautions	3
Mounting/Wiring	4-8
Control Locations -Receiver	9
Control Locations - Remote	10
General Operation	11
General Setup Menu	12-16
DVD Setup Menu	17-19
System Setup Menu	20-21
AM/FM Tuner Operation	22-23
DVD Operation	24-27
CD Operation	28-29
MP3/WMA Operation	30
DVD/MP3/WMA Information	31-32
Navigation/Auxiliary Modes	33
Warranty	34
Troubleshooting	35
Specifications	Back Cover

DVD Region Management

Some DVD discs can be played only in certain playback modes according to the intentions of the software. As the XDVD8265 plays discs according to their intentions, some functions may not work as intended. Please be sure to read the instructions provided with each disc. This player has been designed to play back DVD software that has been encoded for specific region areas. It cannot play back DVD software encoded for other region areas than the region areas for which it has been designed.

The XDVD8265 will play discs labeled "Region 1" or "All".

DVD region codes:

- 1 - USA, Canada
- 2 - Japan, Europe, South Africa, Middle East
- 3 - Rep. of Korea, Taiwan, Hong Kong, Parts of Southeast Asia
- 4 - Australia, New Zealand, Mexico, South America
- 5 - Eastern Europe, Russia, India, Africa
- 6 - China



Safety Information

Please read all instructions carefully before attempting to install or operate.

Due to its technical nature, it is highly recommended that your DUAL XDVD8265 is installed by a professional installer or an authorized dealer. This product is only for use in vehicles with 12VDC negative ground only.

Safety Notes:

The DVD video display of the in-dash unit will not operate while the vehicle is moving. This is a safety feature to prevent driver distraction. In-dash DVD video functions will only operate when vehicle is in Park and the parking brake is engaged. It is illegal in most states for the driver to view video while the vehicle is in motion.

To prevent damage or injury:

1. Make sure to ground the unit securely to the vehicle chassis ground.
2. Do not remove the top or bottom covers of the unit.
3. Do not install the unit in a spot exposed to direct sunlight or excessive heat or the possibility of water splashing.
4. Do not subject the unit to excessive shock.
5. When replacing a fuse, only use a new one with the prescribed rating. Using a fuse with the wrong rating may cause the unit to malfunction.
6. To prevent short circuits when replacing a fuse, disconnect the wiring harness first.
7. Use only the provided hardware and wire harness.
8. You cannot view video while the vehicle is moving. Find a safe place to park and engage the parking brake.
9. If you experience problems during installation, consult your nearest DUAL dealer.
10. If the unit malfunctions, press the reset button first. If the problem still persists, consult your nearest DUAL dealer or call tech assistance @ 1-866-382-5476.
11. To clean the monitor, wipe only with a dry silicone cloth or soft cloth. Do not use a stiff cloth, or volatile solvents such as paint thinner and alcohol. They can scratch the surface of the panel and/or remove the printing.
12. When the temperature of the unit falls (as in winter), the liquid crystal inside the screen will become darker than usual. Normal brightness will return after using the monitor for a while.

Additional notes:

1. When extending the ignition, battery or ground cables, make sure to use automotive-grade cables or other cables with an area of 0.75mm (AWG 18) or more to prevent voltage drops.
2. Do not touch the liquid crystal fluid if the LCD is damaged or broken. The liquid crystal fluid may be hazardous to your health or fatal. If the liquid crystal fluid from the LCD contacts your body or clothing, wash it off with soap immediately.

This device complies with part 15 of the FCC rules and regulations.

Operation is subject to the following two conditions:

- 1) This device may not cause harmful interference, and
- 2) This device must accept any interference received, including interference that may cause undesired operation.

Preparation

Please read entire manual before installation.

Before You Start

- Disconnect negative battery terminal. Consult a qualified technician for instructions.
- Avoid installing the unit where it would be subject to high temperatures, such as from direct sunlight, or where it would be subject to dust, dirt or excessive vibration.

Getting Started

Insert the supplied keys into the left and right sides as shown, and slide the unit out of the mounting sleeve.

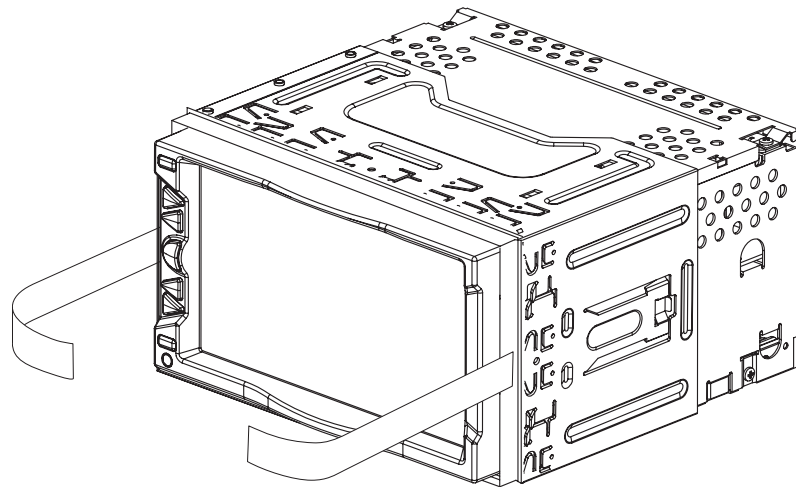

Mounting Options

1. Rear ISO-DIN (using OEM factory radio mounting brackets):
 - Remove factory radio mounting brackets and attach to the left and right sides of the XDVD8265 chassis.
 - See diagram on page 5.
 2. Rear ISO-DIN (using included universal mounting brackets):
 - Attach left and right mounting brackets to the left and right sides of the XDVD8265 chassis.
 - See diagram on page 5.
 3. Front load (using mounting sleeve):
 - Install mounting sleeve into opening, bending tabs to secure.
- Connect wiring harness and antenna as shown on pages 6-7. Consult a qualified technician if you are unsure.
 - Certain vehicles may require a wiring harness adapter (sold separately).
 - Test for correct operation and mount the XDVD8265 according to your application.
 - The trim ring may be required for some applications. Using a utility knife, score the trim ring on the back side to trim the depth and width as needed. Use the supplied 4 strips of double-sided tape to attach the trim ring.
 - Mount the iplug™ adapter to any smooth clean surface using the supplied double-sided tape or #2 x 3/8" Phillips head screws.

Mounting Options

TYPICAL REAR-LOAD ISO-DIN MOUNTING

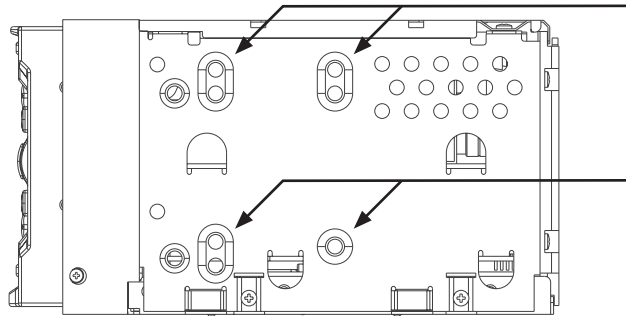

Mount factory radio brackets to the chassis using the supplied M5 x 6 mm screws.

TYPICAL REAR-LOAD MOUNTING USING UNIVERSAL MOUNTING BRACKETS

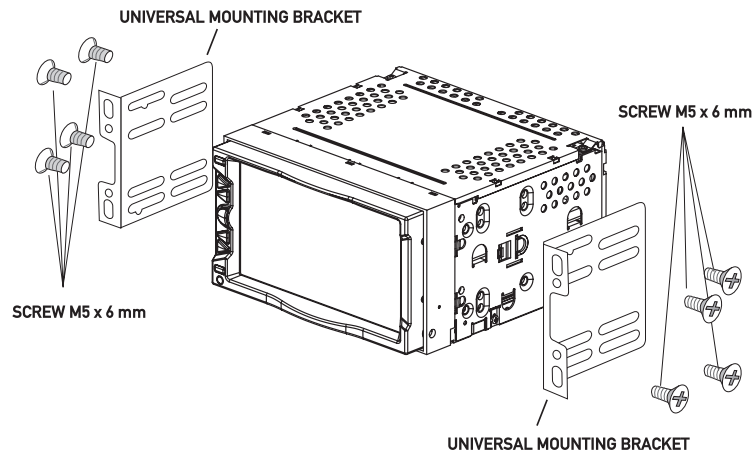

TYPICAL FRONT-LOAD MOUNTING USING MOUNTING SLEEVE AND TRIM RING

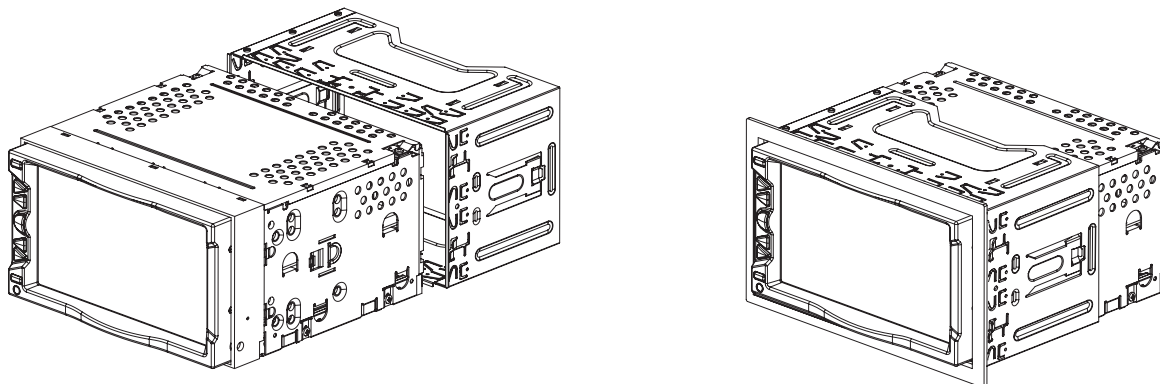

Wiring Diagram - Inputs/Outputs

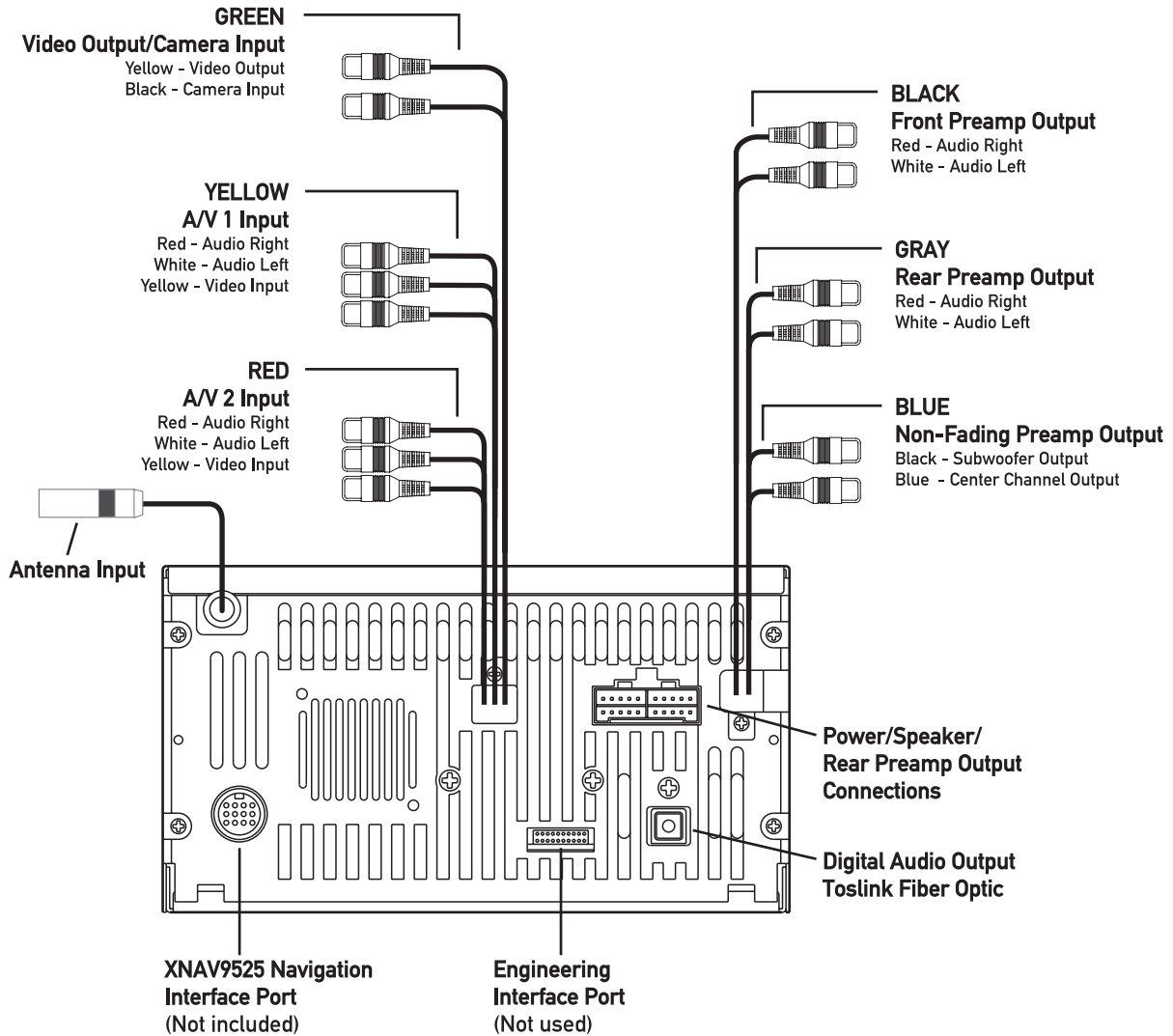

Wiring Notes:

Center channel output

The center channel audio output (Blue RCA) must be connected to an external amplifier (not included) to hear center channel audio.

Subwoofer output

The subwoofer audio output (Black RCA) is active in all audio modes.

Video output

The video output (Yellow RCA) provides composite video output for rear monitors, etc.

Rear view camera

The rear camera input (Black RCA) can be connected to an optional rear view camera.

Wiring Diagram - Power/Speakers

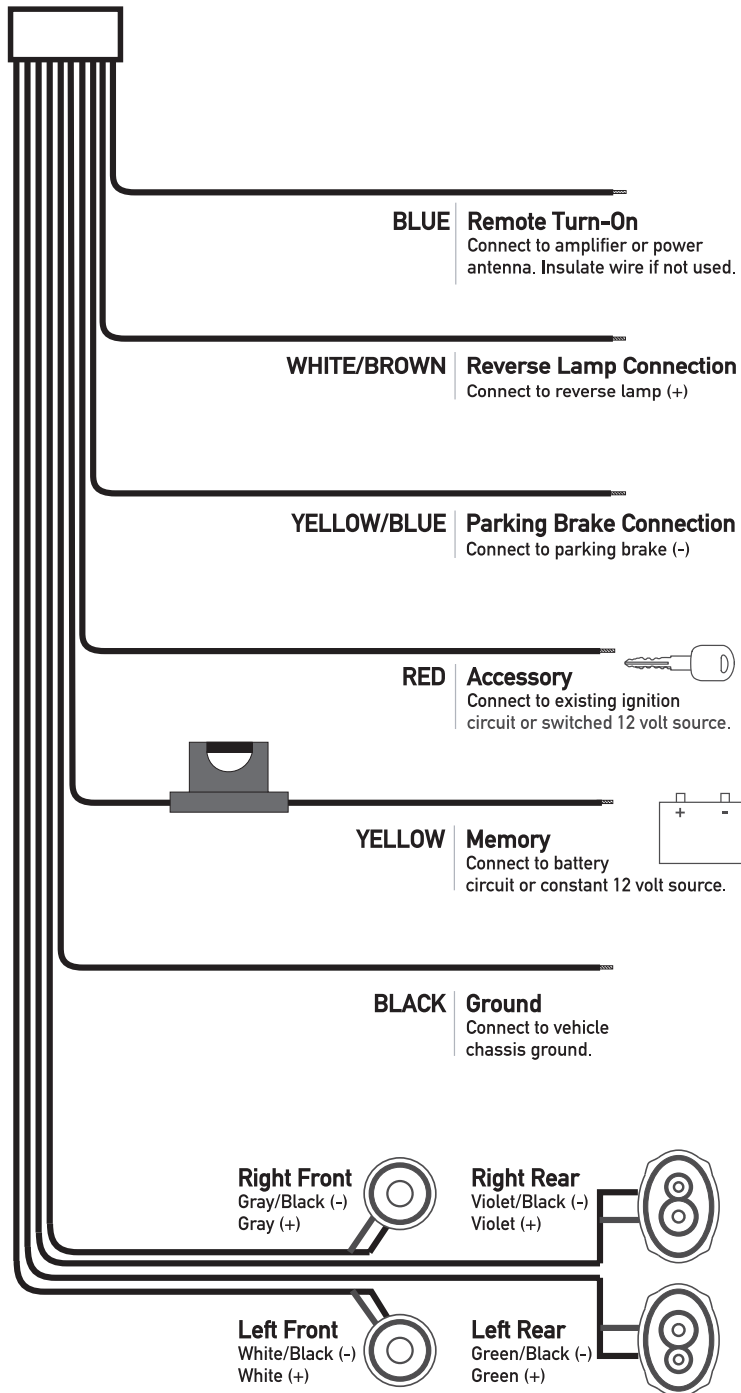

Connecting the parking brake lead (Yellow/Blue -)
The Yellow/Blue lead MUST be connected for the in-dash monitor to operate properly. The DVD video display of the in-dash unit will not operate while the vehicle is moving. This is a safety feature to prevent driver distraction. In-dash DVD video functions will only operate when vehicle is in Park and the parking brake is engaged. It is illegal in most states for the driver to view video while the vehicle is in motion. This wire must be connected in accordance with all local, state and federal laws in your area.

Connecting the reverse lamp lead (White/Brown +)
The White/Brown lead connects to the vehicle reverse lamp circuit (optional). When reverse gear is selected, the unit will automatically select rear view mode and display the image on screen. This will allow the driver to view images from a back-up camera (optional) connected to the dedicated rear camera input.
Note: The **Rear View** camera must be set to ON to view images when reverse gear is selected. See page 20 for details.

Speaker Connections

Do not connect any speaker leads to chassis ground or each other as severe damage will occur. Use 4 ohm speakers with a 60 watt (minimum) power rating only.

Fuses

When replacing a fuse, make sure new fuse is the correct type and amperage. Using an incorrect fuse could damage the unit. To prevent accidental shorts, insulate any unused wires.

Wiring Diagram - Optional A/V Connections

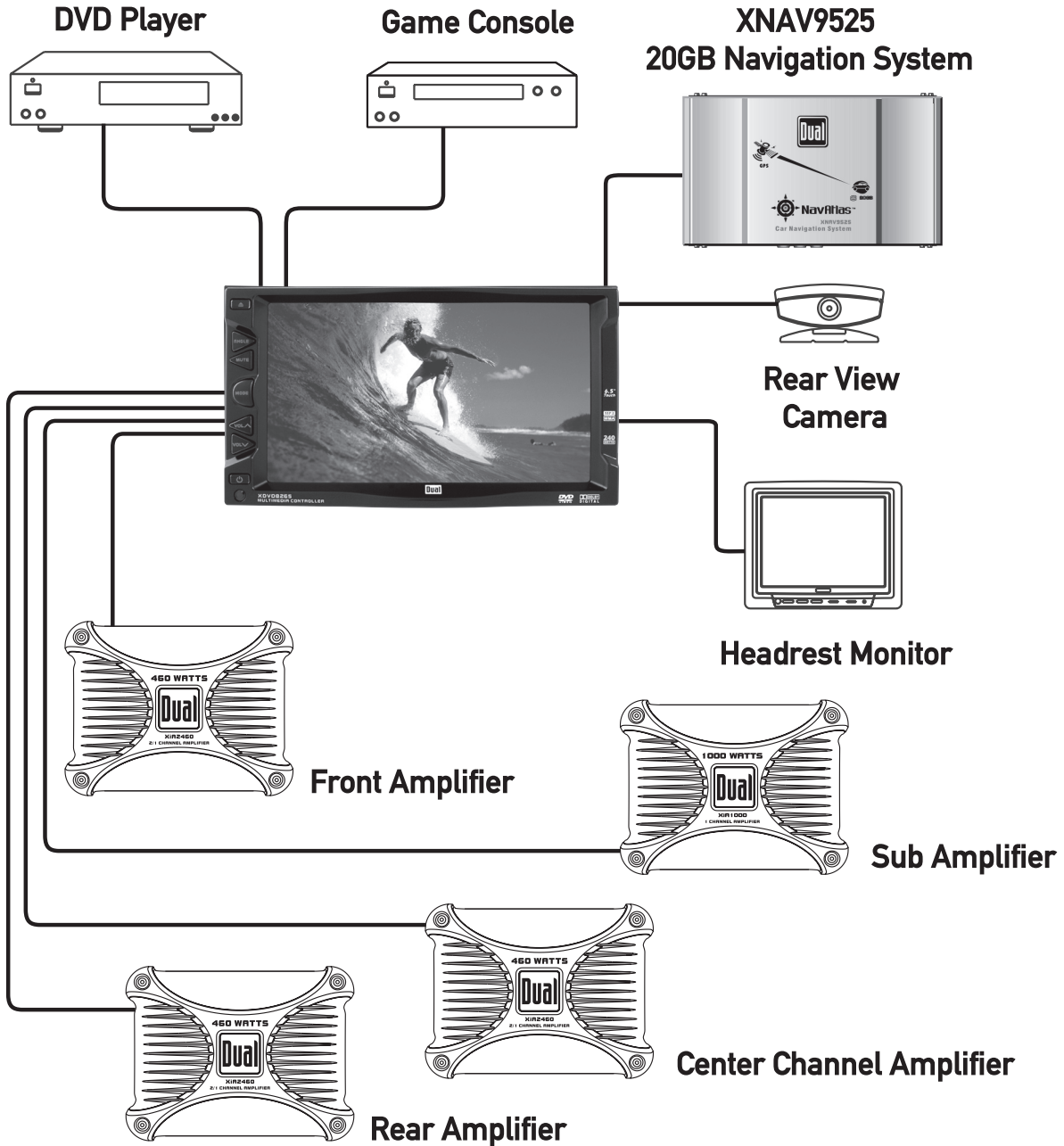



The diagram above illustrates the connection capabilities of the XDVD8265. Two separate Audio/Video inputs allow the connection of a DVD player or game console. A dedicated video output provides video signal for external monitors while a rear view camera can be connected to provide assistance when backing up your vehicle. Visit your local DUAL dealer for more details.

* All items shown above are optional and sold separately.

Control Locations - Receiver



- ① Eject - Press  to allow the front panel to slide down to insert/eject discs.
- ② Reset - Press and hold the **RESET** button to reset the main unit upon initial installation or if abnormal operation occurs. The reset button is located to the right side of the disc slot.
- ③ Angle - Press to select between 4 different monitor view angles.
- ④ Mute - Press to silence the audio, press again to cancel.
- ⑤ Mode - Press to select between various modes of operation.
- ⑥ Volume Up - Press to increase the volume level.
- ⑦ Volume Down - Press to decrease the volume level.
- ⑧ Power - Press  to turn the unit on/off.
- ⑨ Infrared Sensor
- ⑩ TFT Touch Screen LCD

Caution

- Due to its highly technological design, the XDVD8265 faceplate is **NOT** removable. Do not attempt to remove the faceplate.
- This model incorporates a motorized moving monitor. Before final installation, make sure the monitor will not obstruct the dash or shifter.
- Upon installation, do not attempt to move the monitor by hand. Use the **ANGLE** button on the faceplate or the remote control only.



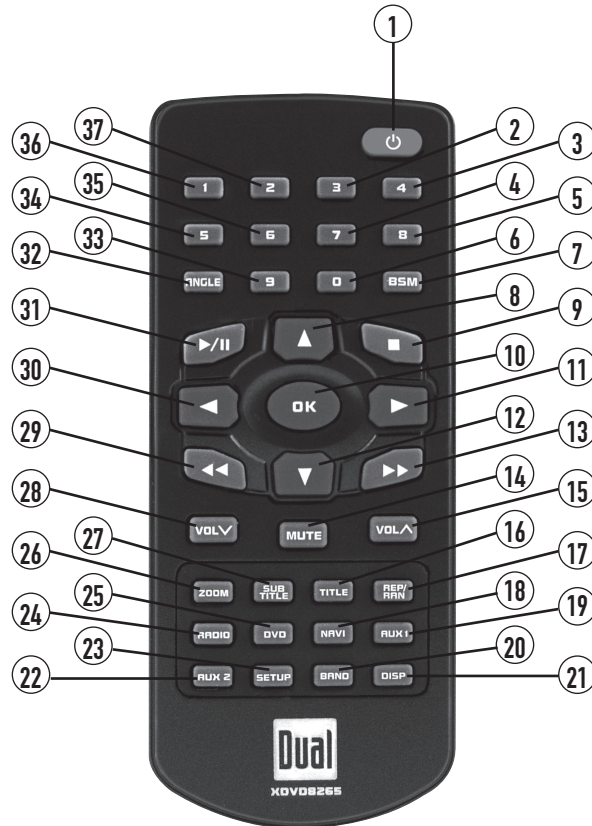





Control Locations - Remote



- | | | |
|-------------------------------|-----------------|---------------------------------|
| ① Power | ⑭ Mute | ⑳ Subtitle |
| ② Preset #3 | ⑮ Volume Up | ㉑ Volume Down |
| ③ Preset #4 | ⑯ Title | ㉒ Fast Forward/Manual Tune Down |
| ④ Preset #7 | ⑰ Repeat/Random | ⑳ 4-Way - Left |
| ⑤ Preset #8 | ⑱ Navi | ㉓ Play/Pause |
| ⑥ Key #0 | ㉒ Aux 1 | ㉔ Angle |
| ⑦ BSM (Best Station Memory) | ㉓ Band | ㉕ Key #9 |
| ⑧ 4-Way - Up | ㉔ Display | ㉖ Preset #5 |
| ⑨ Stop | ㉕ Aux 2 | ㉗ Preset #6 |
| ⑩ OK/Enter | ㉖ Setup Menu | ㉘ Preset #1 |
| ⑪ 4-Way - Right | ㉗ Radio | ㉙ Preset #2 |
| ⑫ 4-way - Down | ㉘ DVD | |
| ⑬ Fast Forward/Manual Tune Up | ㉙ Zoom | |

* The remote control uses one 3 volt Lithium CR2025 battery. For best performance, replace only with CR2025 or equivalent.

General Operation

Power On/Off	Press  to turn the unit on/off. Due to its use of advanced microprocessors, if the unit is on, then turned off, it can not be turned on again for 18 seconds (microprocessor sleep/boot time).
Eject	Press  to allow the front panel to slide down and access the disc slot.
Monitor Angle Position	<p>Press ANGLE momentarily to select between 4 different monitor view angles. Press ANGLE for more than 1 second to return the monitor to the fully open or fully closed positions.</p> <p>Notes:</p> <ul style="list-style-type: none"> • The color of the LCD monitor varies between viewing angles. Select the angle with the most optimum view for your location. • The last position of the monitor is saved in memory. The monitor will return to its last position automatically the next time it is opened.
Mute	Press MUTE to silence the audio;  will appear in the OSD (On Screen Display). Press MUTE again to cancel.
Mode	<p>From the front panel or remote control: Press MODE to select between tuner, DVD player, Navi (optional), AV1 and AV2 inputs. Modes of operation are indicated in the OSD.</p> <p>Using the touch screen: Gently press the upper right corner of the screen to display the OSD menu bar and press RADIO, DVD, AV1 or AV2 in the OSD menu bar to select the desired source. The OSD menu bar appears all the time in radio mode.</p> <p>Notes:</p> <ul style="list-style-type: none"> • The vehicle must be in park and the parking brake applied to view video on the in-dash monitor. • As a safety feature, “WARNING! PICTURE OFF FOR YOUR SAFETY” will show on the display when the vehicle's parking brake is not engaged. DVD, AV1 and AV2 audio can be heard while the vehicle is in motion. • The video display of the in-dash unit will not operate while the vehicle is moving. This is a safety feature to prevent driver distraction. In-dash video functions will only operate when vehicle is in Park and the parking brake is engaged. It is illegal in most states for the driver to view video while the vehicle is in motion. Refer to local laws in your area.
Volume	<p>From the front panel or remote control: Press VOL  to increase the volume level (00-46). Press VOL  to decrease the volume level.</p> <p>Using the touch screen: Press the screen to display the OSD menu bar and press  to display the volume level bar. Press  or  to adjust the volume.</p>

OSD Menu/General Setup Menu

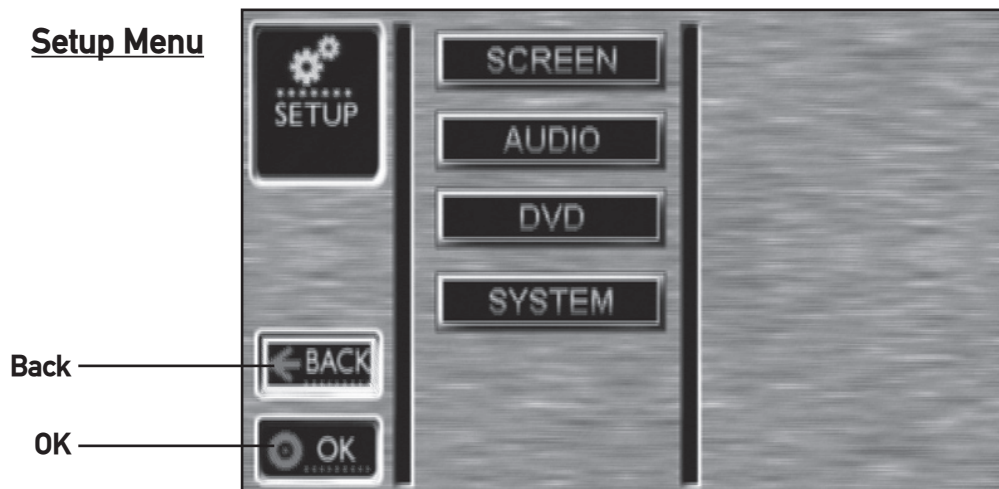
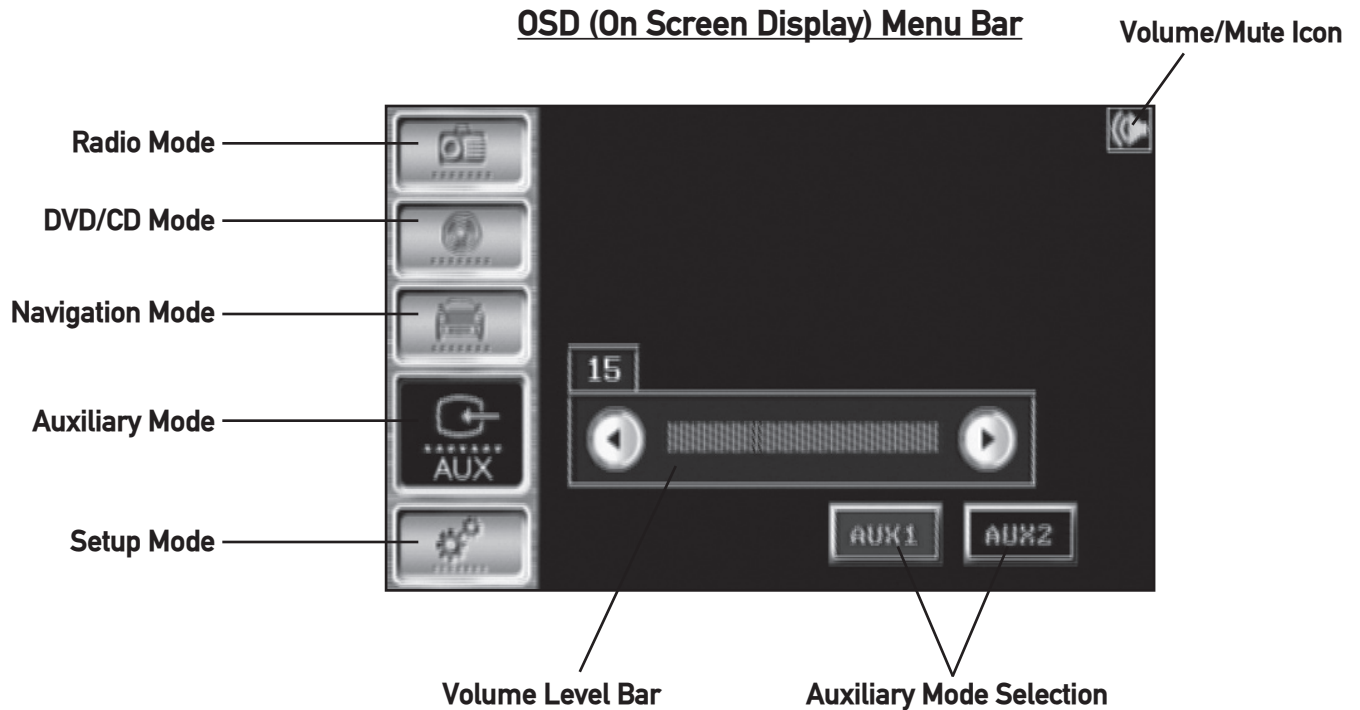

General Setup Menu



Gently press the upper right corner of the screen to display the OSD menu bar. Press the **SETUP** icon to enter general setup menu. Press **BACK** or **OK** to exit the general **SETUP** menu. The OSD menu bar appears all the time in radio mode.

General Setup Menu

Screen Menu Page

Press **SCREEN** to access screen menu page and adjust the following screen settings. Press **▲** or **▼** to adjust settings and levels. When selected, the menu item will be highlighted in blue. The current level setting is indicated by a red bar.

Brightness

Press **BRIGHT** to adjust the brightness (-15 minimum / +15 maximum).

Contrast

Press **CONT** to adjust the contrast (-15 minimum / +15 maximum).

Sub-Red (Color)

Press **S-RED** to adjust the sub-red color (-15 minimum / +15 maximum).

Sub-Blue (Color)

Press **S-BLUE** to adjust the sub-blue color (-15 minimum / +15 maximum).

Default Settings

Press **DEFAULT** to load default factory settings.

Press **BACK** to return to the previous menu page.

Press **OK** to save settings and exit the system setup menu.

**Screen Menu Page
(Brightness Shown)**

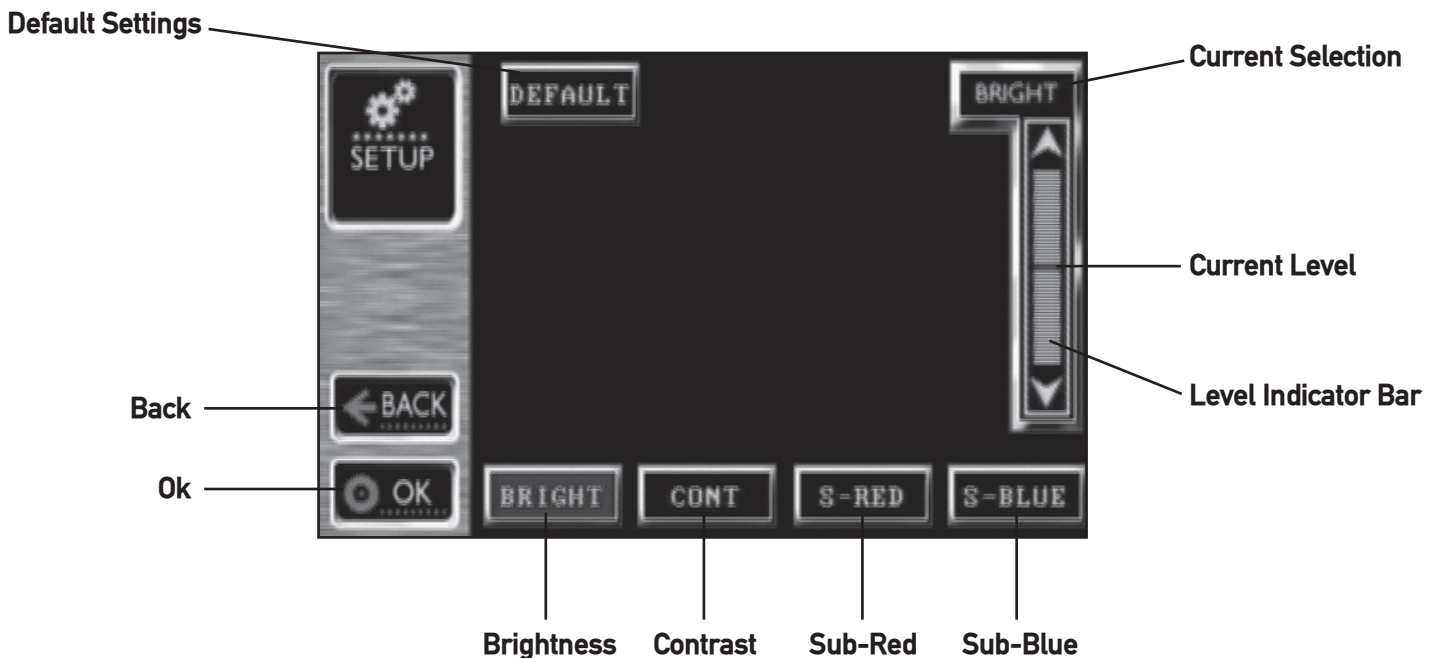

General Setup Menu

Audio Menu Page

Press **AUDIO** to access audio menu page and press **BASS/TREBLE** to access bass/treble adjustment page. Press **◀** or **▶** to adjust bass/treble levels. When selected, the menu item will be highlighted in blue. The current bass/treble level is indicated by a red bar.

Bass

Press **BASS** to adjust the bass (-6 minimum / +6 maximum).

Treble

Press **TREBLE** to adjust the treble (-6 minimum / +6 maximum).

Press **BACK** to return to the previous menu page.

Press **OK** to save settings and exit the system setup menu.

Audio Menu Page

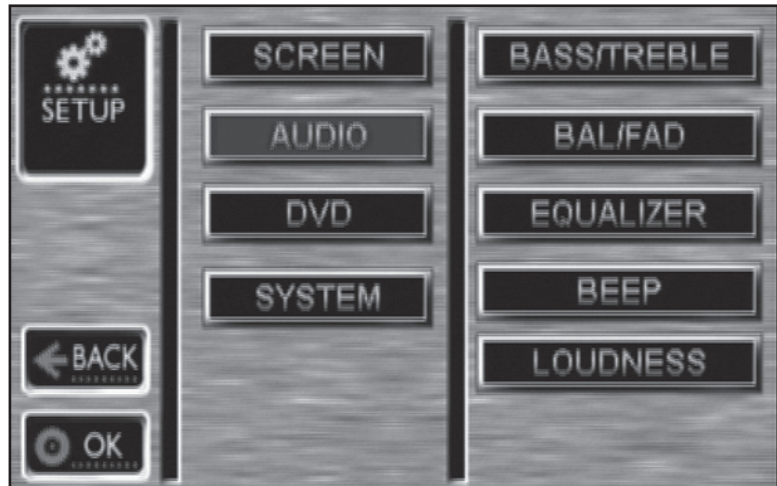

Bass/Treble Adjustment Page



General Setup Menu

Balance/Fader

Press **BAL/FAD** to access balance/fader adjustment page.

Press **F-L** to hear Front Left output only.

Press **F-R** to hear Front Right output only.

Press **R-L** to hear Rear Left output only.

Press **R-R** to hear Rear Right output only.

Press **ALL** to hear all channels (default setting).

Press **BACK** to return to the previous menu page.

Press **OK** to save settings and exit the system setup menu.

Optional Adjustment Method

Use the OSD 4-way navi to adjust the balance and fader.



From the remote control:

Use **▶** to move yellow box to **POS**. Press **OK** to select **POS**, then use **▲/▼/◀/▶** to adjust the balance and fader.

Balance/Fader Adjustment Page

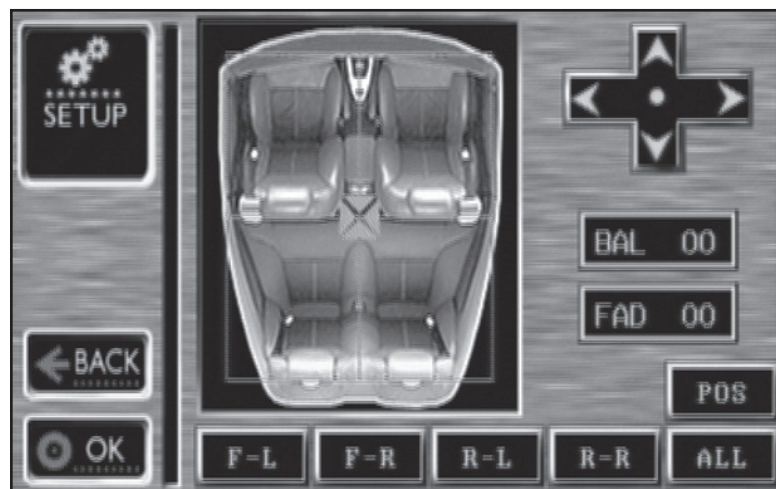

General Setup Menu

Equalizer	Press EQUALIZER to access equalizer adjustment page. Press desired preset EQ curve - POP , JAZZ , CLASSIC , ROCK or FLAT .
Confirmation Beep	Press BEEP to access the beep adjustment page. Press ON to hear confirmation beeps.
Loudness	Press LOUDNESS to access the loudness adjustment page. Press ON to activate the loudness curve at low volumes.
	Press BACK to return to the previous menu page. Press OK to save settings and exit the system setup menu.

Equalizer Adjustment Page

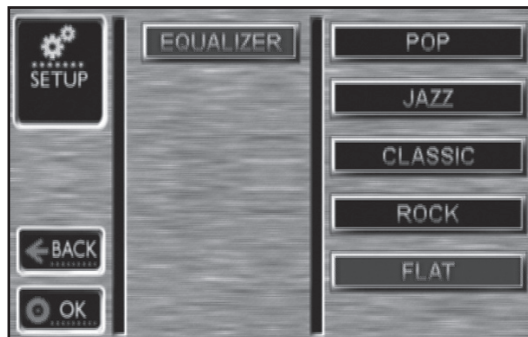

Confirmation Beep Adjustment Page



Loudness Adjustment Page



DVD Setup Menu

DVD Menu Page	Press DVD to access DVD menu page.
DVD Audio	Press DVD AUDIO to access DVD audio adjustment page.
Downmix	Press DOWNMIX to access audio downmix adjustment page. Press adjustment bar to select between LO/RO , LT/RT , 3D SURROUND and OFF .
SPDIF	Press SPDIF to access SPDIF adjustment page. Press desired digital output mode - OFF , RAW or PCM .
	Press BACK to return to the previous menu page. Press OK to save settings and exit the system setup menu.

DVD Menu Page

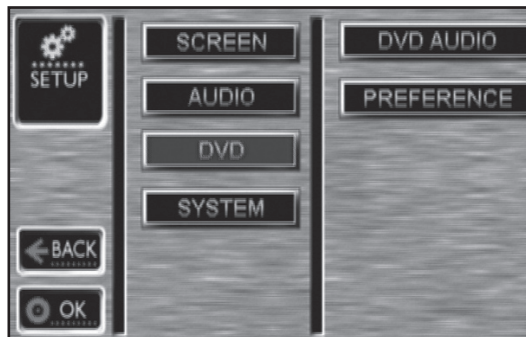

DVD Audio Adjustment Page



SPDIF Adjustment Page



DVD Setup Menu

DVD Preference	Press PREFERENCE to access DVD preferences page.
Disc Audio	Press desired disc audio language - ENGLISH, FRENCH, SPANISH, CHINESE, JAPANESE, KOREAN, RUSSIAN or THAI.
Disc Menu	Press desired disc menu language - ENGLISH, FRENCH, SPANISH, CHINESE, JAPANESE, KOREAN, RUSSIAN or THAI.

Notes:
Some DVD discs can be played only in certain playback modes according to the intentions of the software. As the XDVD8265 plays discs according to their intentions, some functions may not work as intended. Please be sure to read the instructions provided with each disc.

DVD Preference Page

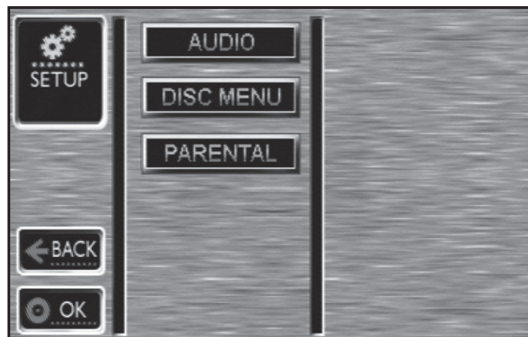

Disc Audio Adjustment Page



Disc Menu Adjustment Page



DVD Setup Menu

Parental Control	Press PARENTAL and enter the 4-digit password to access the parental control settings. Press desired parental control level - Kid Safe, G, PG, PGB, PGR, R, NC17 or ADULT . The default password is 1234 .
Change Password	Press PARENTAL then N to change the password. 1. Enter old 4-digit password then enter a new 4-digit password. 2. Enter the new 4-digit password again to confirm. Press C to clear the entry. Press BACK to return to the previous menu page. Press OK to save settings and exit the system setup menu.

Parental Control Page



Change Password Page



Confirm Password Page



System Setup Menu

<u>System Menu Page</u>	Press SYSTEM to access system preferences page.
Rear View Camera	Press REAR VIEW to access rear view camera adjustment page. Press ON to automatically select rear view mode and display the image on screen when the vehicle is in reverse.
Mirror Image (Rear View Camera Input)	Press MIRROR to access mirror image (rear view camera input) adjustment page. Press ON to mirror the image displayed on screen when the vehicle is in reverse.
Revision Page	Press REVISION to access the system revisions page.
System Reset (Load default DVD settings)	Press RESET to access the system reset page. Press YES to load default DVD settings. The system reset function resets the DVD settings only. See page 9 to reset the main unit.
Dimmer	Press DIMMER to access the dimmer adjustment page. Press ON to decrease the level of TFT LCD backlighting.
Navigation (XNAV9525 integration)	Press NAVI to access the navigation operation page. Press INTEGRATED to simultaneously view map and listen to another audio source. Press SEPARATE for independent operation (XNAV9525 sold separately).
Grid (OSD)	Press GRID to access grid OSD adjustment page. Press ON to activate the OSD grid. Press OFF to hide the OSD grid.

System Menu Page



Rear View Camera Adjustment Page

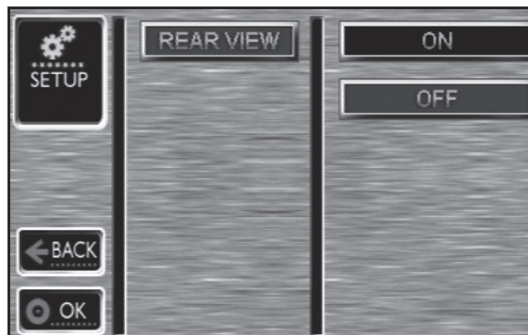

System Setup Menu

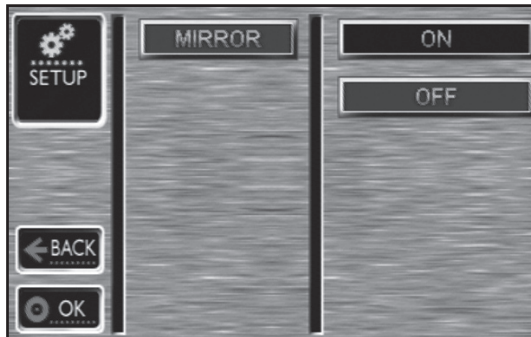

Mirror Image Adjustment Page

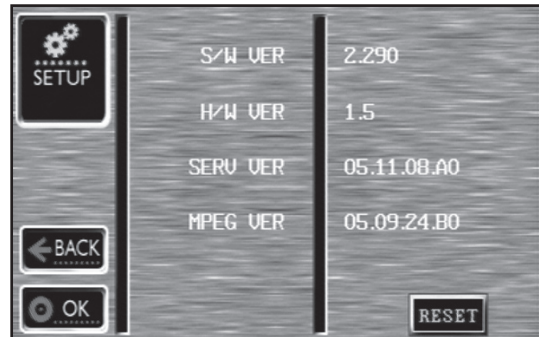

Revision Page



System Reset Page



Dimmer Adjustment Page

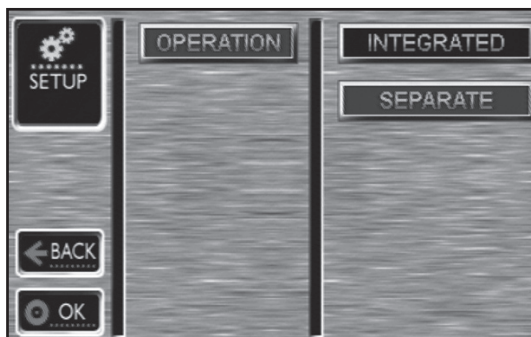

Navigation Operation Page



Grid OSD Adjustment Page

AM/FM Tuner Operation



- Tuner Mode** | The default mode is AM/FM tuner when the unit is first initialized or reset. Press **RADIO** icon to select AM/FM tuner mode.

 From the remote control:
 Press **RADIO** to select AM/FM tuner mode.
- Seek Tuning** | Press ◀ or ▶ momentarily to seek the next strong station. **SEEK** will illuminate blue.
- Manual Tuning** | Press ◀ or ▶ more than 2 seconds, then release. Press ◀ or ▶ momentarily to move radio frequency up or down one step at a time. **TUNE** will illuminate blue.

 From the remote control:
 Press ◀◀ or ▶▶ to perform manual tuning.
- Band** | Press **FM1**, **FM2**, or **AM** to select desired band.

 From the remote control:
 Press **BAND** to select desired band.

AM/FM Tuner Mode

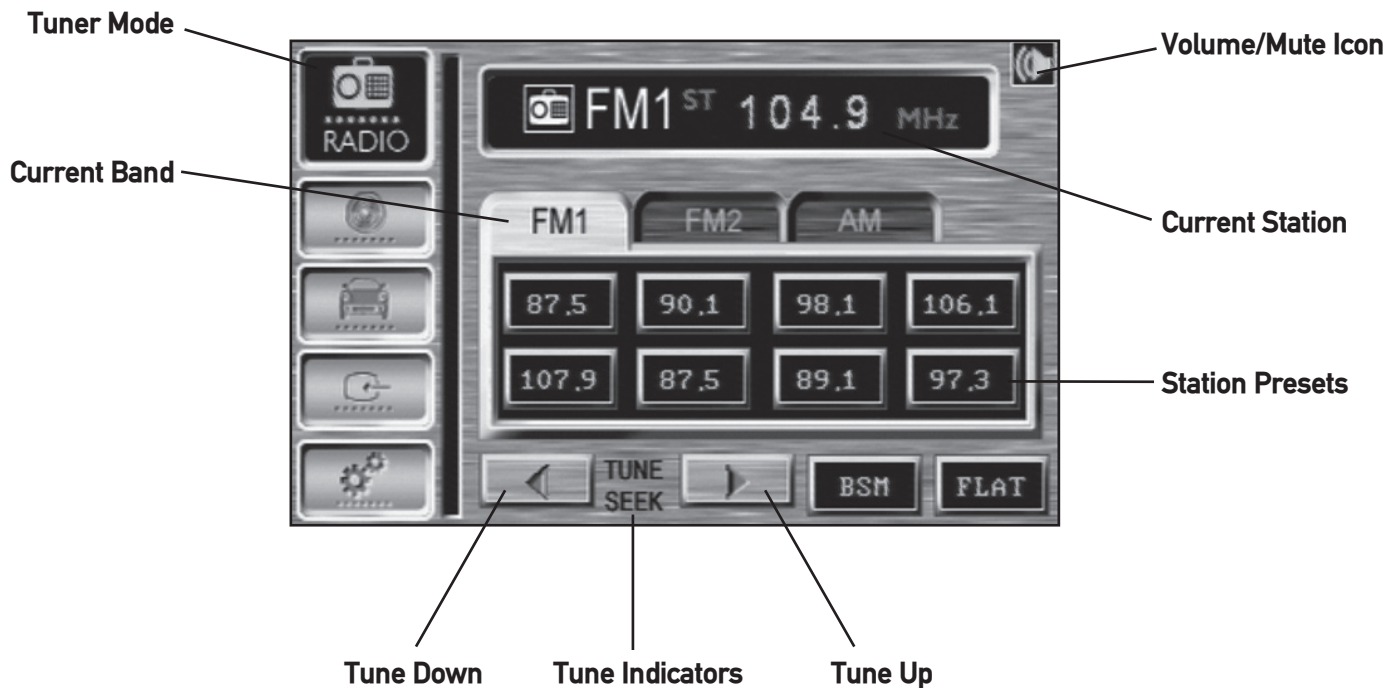

AM/FM Tuner Operation

Storing and Recalling Station Presets

Up to 16 FM stations and 8 AM stations can be stored. To store a station, select the desired band and station. Press and hold the desired station button in the OSD for more than 2 seconds. When stored, the station color will change to blue in the OSD. The station can be recalled anytime by pressing the corresponding station button.

From the remote control:

Press and hold the desired preset button (1~8) for more than 2 seconds. The station can be recalled anytime by pressing the corresponding preset button (1~8).

Best Station Memory

Press **BSM** in the OSD to automatically store the eight strongest stations in the current band.

Preset EQ Curves

Press **FLAT** (default) or current equalization curve to select desired preset EQ curve - **POP, JAZZ, CLASSIC, ROCK** or **FLAT**.

AM/FM Tuner Mode

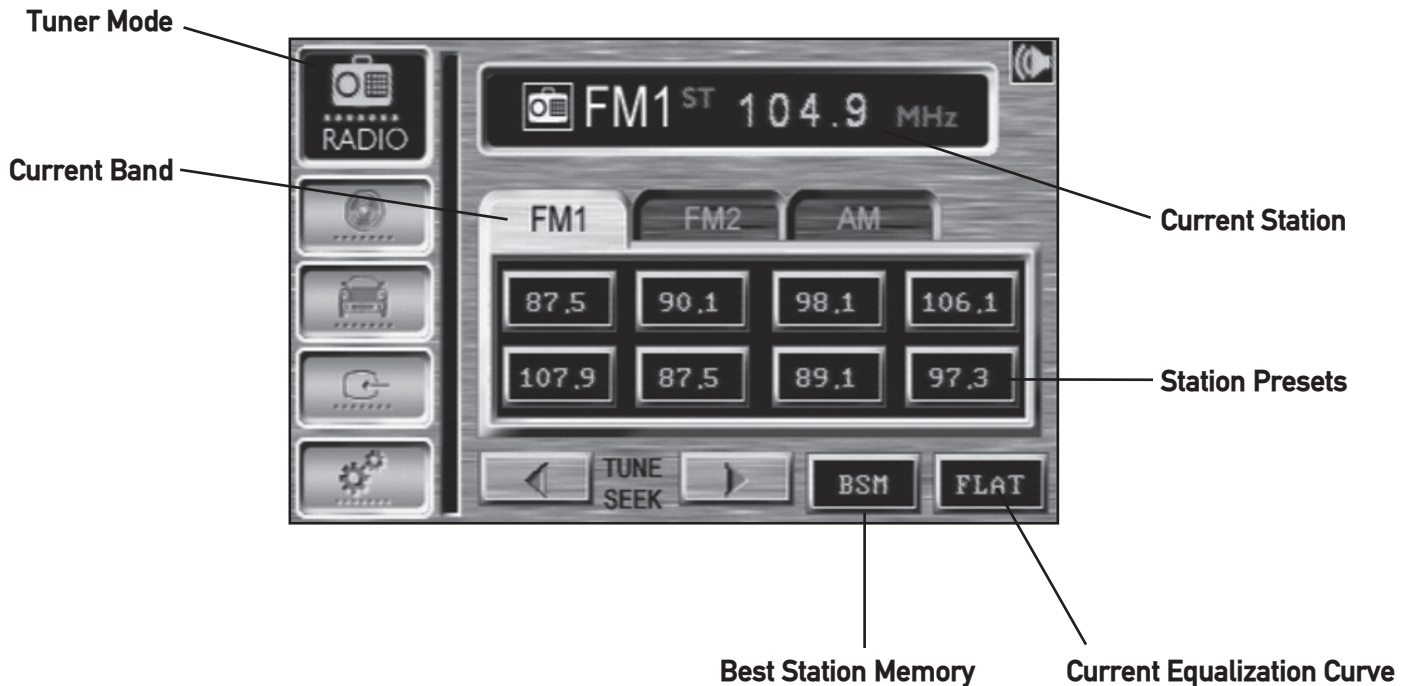

DVD Operation - OSD Menu



Insert Disc

Press  to allow the front panel to slide down. With the label facing up, insert a disc. The front panel will return to the last position in memory and the disc will automatically begin playback.

Eject Disc

Press  to allow the front panel to slide down and eject the disc. If the disc is not removed within 10 seconds, the unit will reload the disc. The unit does not have to be turned on.



OSD Menu

Gently press the upper right corner of the screen to display the DVD OSD menu for 5 seconds. In general, pressing /|| or **OK** will start disc playback. Some discs will play automatically when inserted.



OSD Grid Menu

The OSD grid menu appears for 5 seconds after the OSD menu - providing an overview of the screen controls. Gently press the screen in the appropriate area to perform desired function. The OSD grid menu can be turned off in the system setup menu. See page 20 for details.

Playback Start

"" may appear on the display during operation. "" means that feature or operation is not permitted by the DVD player at this time.

Playback Stop

Press  momentarily. The unit will return to the DVD logo and display . If /|| is pressed, the unit will resume operation from the last position in memory.

DVD OSD Menu

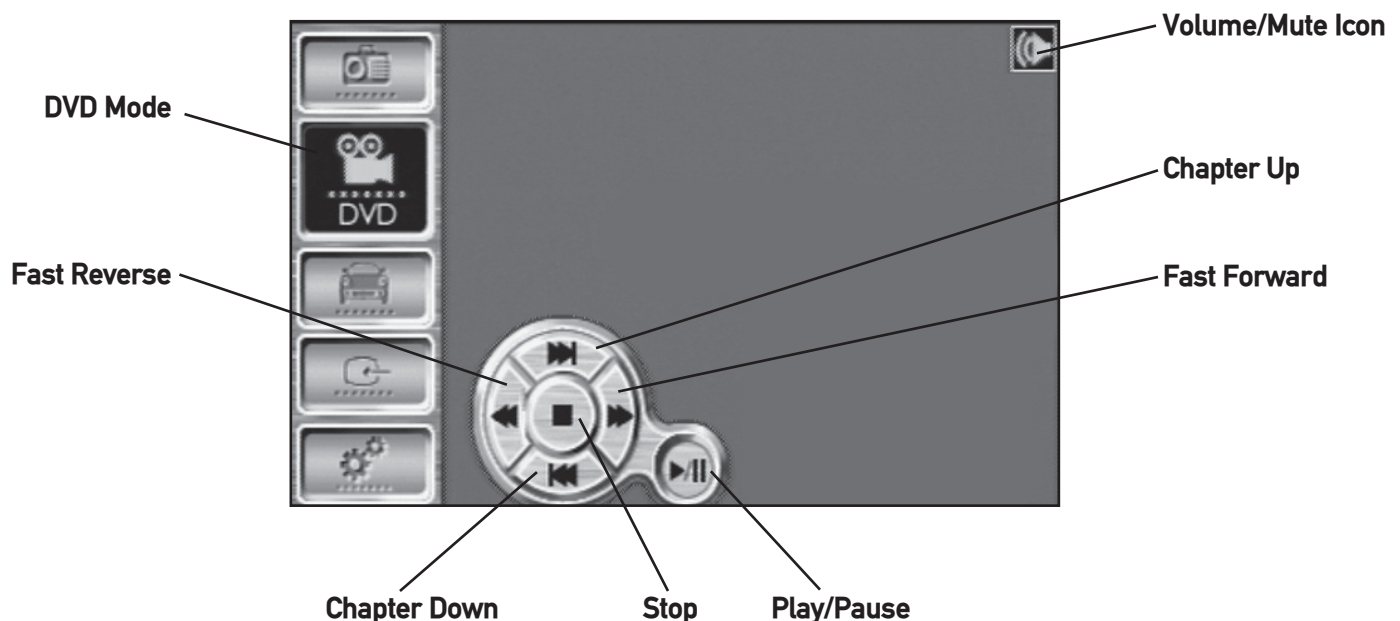

DVD Operation - OSD Menu

Playback Full Stop	Press ■ two times. The unit will return to the DVD logo and display ■. If ►/■ is pressed, the unit will resume operation from the beginning of the disc.
Pause	Press ►/■ to temporarily stop playback. Press ►/■ to resume playback.
Chapter Select	Press ►► to skip to the beginning of the next chapter. Press ◄◄ to return to the beginning of the current chapter. Pressing ◄◄ again skips to the beginning of the previous chapter. From the remote control: Press ► to perform the ►► function. Press ◄ to perform the ◄◄ function.
Fast Forward and Reverse	Press ◄◄ or ►► to fast forward or fast reverse in 2x, 4x, 8x, 16x and 32x modes. Press ►/■ to cancel fast forward or fast reverse. There is no audio output during fast forward or reverse modes.
Slow	Press ►/■, then press ◄◄ or ►► to activate slow playback. Slow playback speed includes ► 1/2, 1/4, 1/8 and 1/16 in forward and ► 1/2, 1/4, 1/8 and 1/16 in reverse. Press ►/■ to resume playback. There is no audio output during slow mode.

DVD Grid OSD Menu

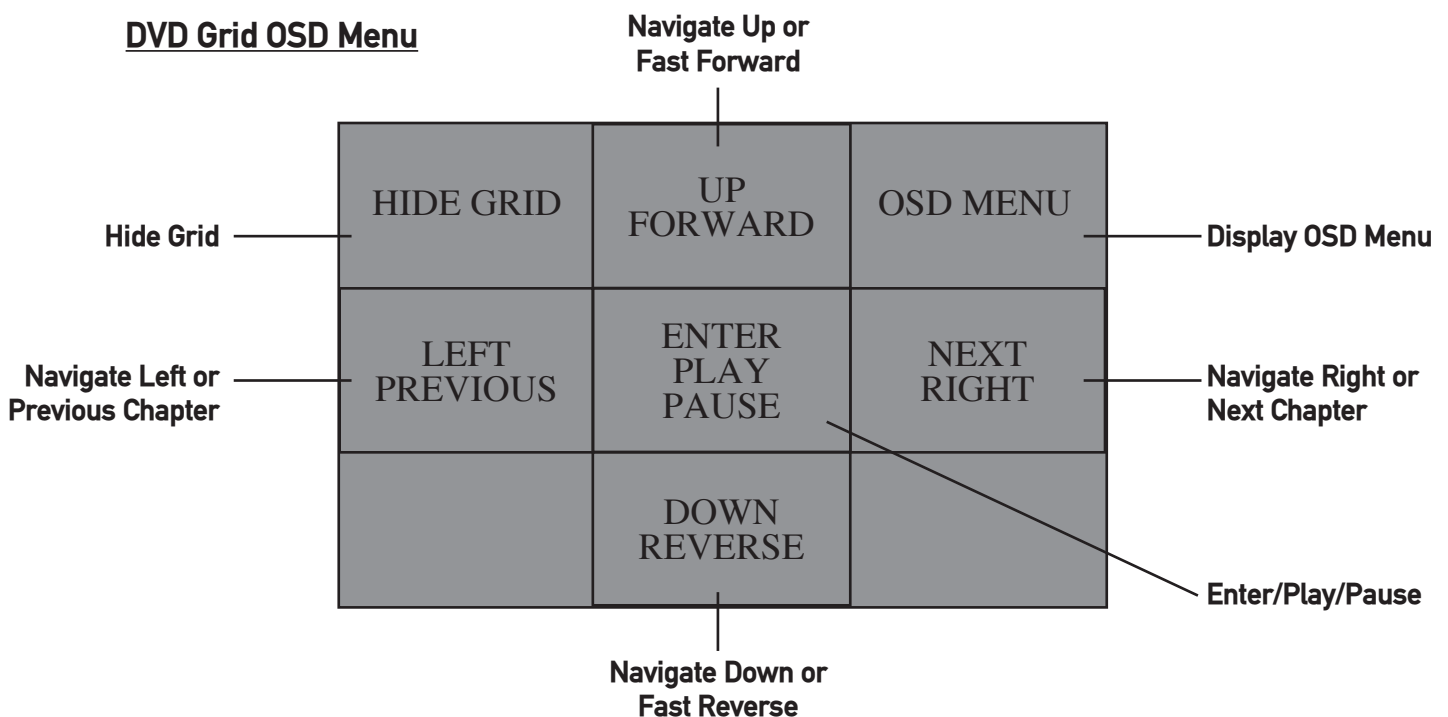

DVD Operation

Root Menu (Main Menu)

Press **ROOT** to select main menu. Press **▲/▼/◀/▶** to select between menu settings and **OK/ENTER** to select/confirm.
Press **▶/||** to resume playback from the last position.

Title Menu

Press **TITLE** to show available titles. Press **▲/▼/◀/▶** to select between titles and **OK/ENTER** to select/confirm.

Repeat

Press **REP** once to repeat the current chapter.
Press **REP** twice to repeat the current title.
Press **REP** three times repeat the entire disc.
Press **REP** again to cancel repeat function.

Selecting DVD Subtitle Language

Press **SUB-T** while playing to switch between available subtitle languages.
Press **SUBTITLE** from the remote control.

Selecting DVD View Angles

Press **ANG** while playing to switch between available viewing angles.

Selecting DVD Audio Languages

Press **AUDIO** while playing to switch between available audio languages.

Notes:

The subtitle language, view angle and audio language features are only available when they are included on the disc. The language and subtitle functions may not work with some discs and they may require some time when selecting between them.

DVD OSD Menu

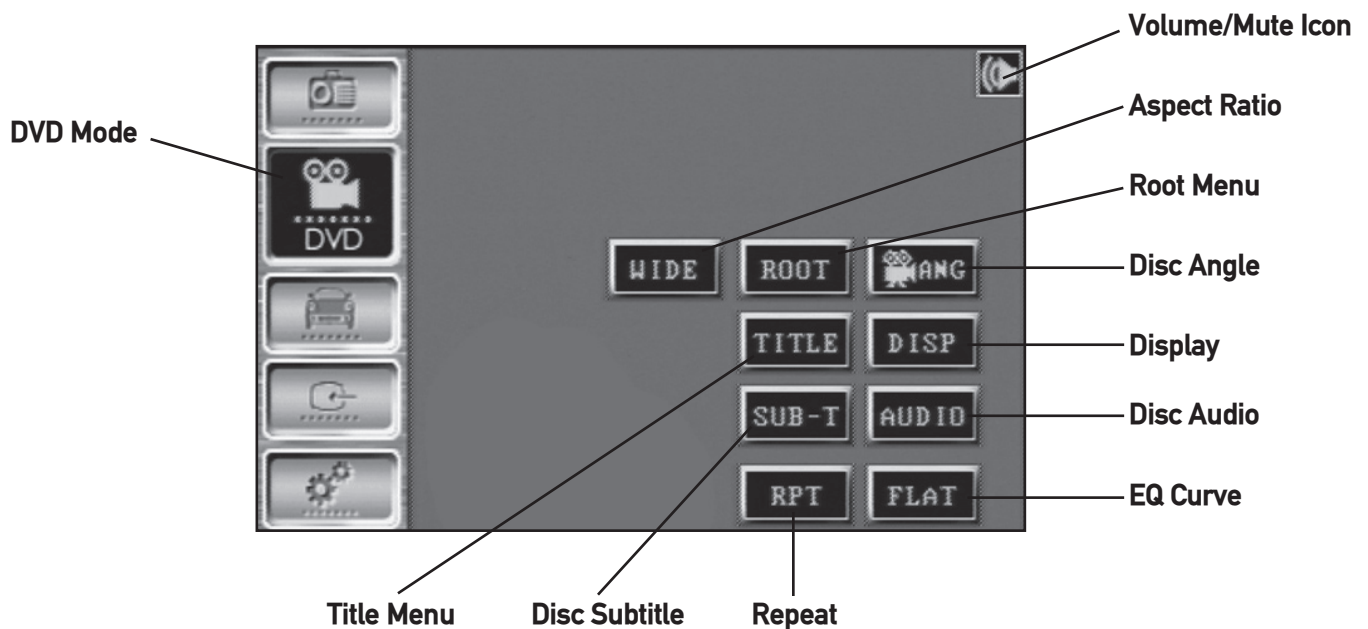

DVD Operation

Display Status	<p>Press DISP to select between the following:</p> <p>TT --/-- CH ---/--- with elapsed title time TT --/-- CH ---/--- with remaining title time TT --/-- CH ---/--- with elapsed chapter time TT --/-- CH ---/--- with remaining chapter time Display Off</p>
Zoom	<p>Press ZOOM to increase/decrease the image size from 2X, 3X, 4X or 1/2, 1/3, 1/4 size.</p>
Direct Title Access	<p>When the disc is stopped, use 1~0 on the remote control to enter the desired title.</p>
Direct Chapter Access	<p>When the disc is playing, use 1~0 on the remote control to enter the desired chapter.</p>
Aspect Ratio	<p>Press WIDE (default) or current aspect ratio to select between WIDE, L-4:3, or P-4:3 aspect ratio. Changing the aspect ratio affects the in-dash monitor and the video output signal.</p>



WIDE - 16:9



L-4:3 - Letterbox



P-4:3 - Pan & Scan

CD Operation



- Play** | Insert a standard size CD into the disc slot. The CD will automatically begin playback when inserted. The currently playing track is shown in green and highlighted in blue.

- Stop** | Press **■**; the unit will stop and display **STOP**.
 Press **▶/||** to resume operation from the beginning of the disc.

- Pause** | Press **▶/||** to temporarily stop playback.
 Press **▶/||** to resume playback.

- Track Select** | Press **▶▶I** to skip to the beginning of the next track.
 Press **I◀◀** to skip to the beginning of the previous track.

From the remote control:
 Press **▶** to perform the **▶▶I** functions.
 Press **◀** to perform the **I◀◀** functions.
 Press **▲/▼** to select desired track and press **OK** to confirm.

- Direct Track Access** | Gently press the screen to select desired track.

From the remote control:
 Enter the desired track using the 1~0 buttons on the remote.

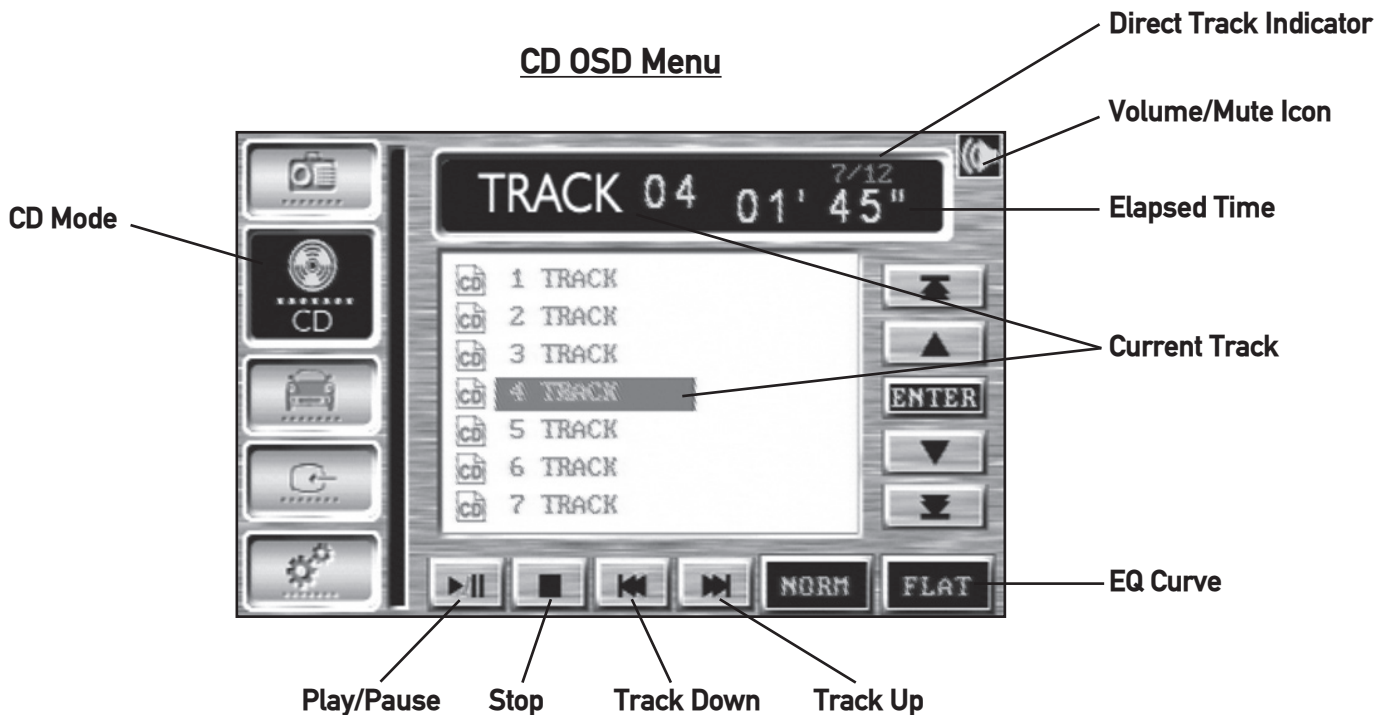

CD Operation

Fast Forward and Reverse

Press ◀◀ or ▶▶ fast forward or fast reverse in 2x, 4x, 8x, 16x and 32x modes. Press ▶/|| to cancel fast forward or fast reverse.

Repeat/Random

Press **NORM** (default) or current playback mode to select between **NORM**, **RPT**, or **RAND** playback modes.

Track Repeat

Select **REP** to repeat the current track.

Track Random

Select **RAND** to play all tracks in random order. Random mode is retained in memory when selecting between modes and when the unit is turned on/off.

Optional Navigation Method

Press ▲ or ▼ to select desired page.
Press ▲ or ▼ to highlight desired track in blue and press **ENTER** to confirm. The currently playing track is shown in green and highlighted in blue.

CD-R/RW Compatibility

Some CD-Rs and CD-RWs may be incompatible with this unit, depending on media type and recording method.

CD OSD Menu

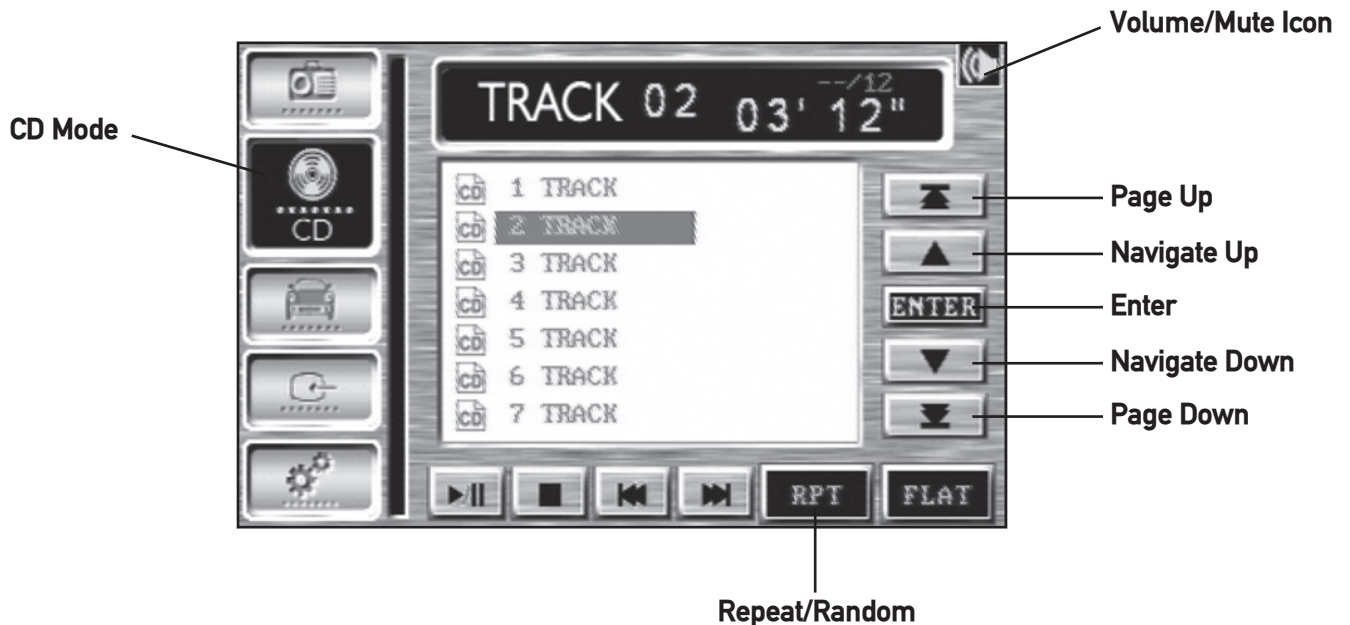

MP3/WMA Operation

Playing an MP3/WMA disc

When an MP3/WMA encoded disc is first inserted, playback will automatically begin with the first file in the root folder. A file must be selected first if there are no files in the root folder.

The current filename is displayed at the top of the screen.

MP3/WMA operation is similar to normal CD operation. See pages 28-29 for details.

Navigation Method

Press **▲** or **▼** to select desired page.
 Press **▲** or **▼** to highlight desired file in blue and press **ENTER** to confirm.
 The currently playing file is shown in green and highlighted in blue.



Press **..** to navigate up one level.

Repeat/Random

Press **NORM** (default) or current playback mode to select between **NORM**, **RPT**, or **RAND** playback modes.

Track Repeat

Select **REP** to repeat the current file.

Track Random

Select **RAND** to play all files in the current folder in random order. Random mode is retained in memory when selecting between modes and when the unit is turned on/off.

MP3/WMA OSD Menu

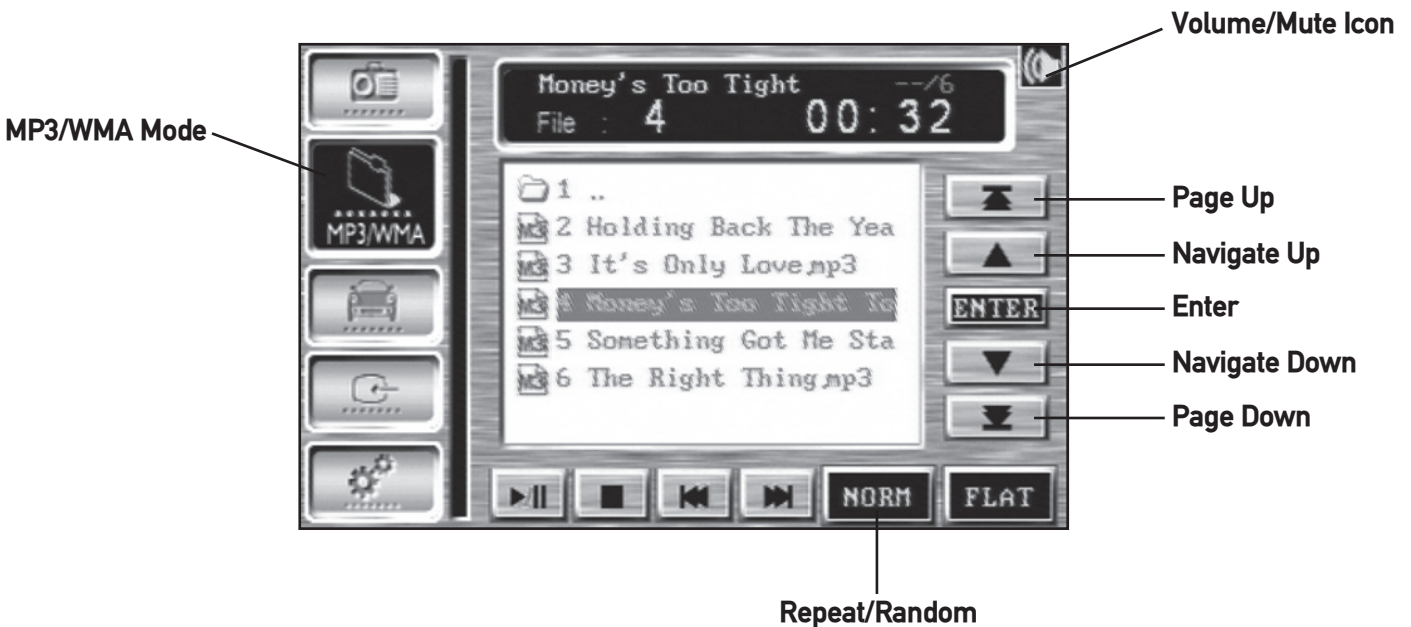

DVD/MP3/WMA Information

Media Compatibility

The following types of discs/files are compatible:

- CD-ROM (ISO), CD-R, CD-RW, DVD+R/RW, DVD-R/RW
- CD-DA, DVD Video
- MP3 data
- WMA data

The following types of discs/files are not compatible:

- WMA files that are protected by DRM (Digital Rights Management)
- WMA lossless format
- Discs recorded with Track At Once or packet writing
- MP3 PRO format
- MP3 playlists
- WAV format
- WMV format
- JPG format
- DivX format
- AVI format
- MPG format

Some recordable DVDs and CDs may be incompatible with this unit, depending on media type and recording method.

Playback Order

MP3/WMA playback sequence is based on recorded order of files and begins in the root folder of the disc. Any empty folders or folders that do not include MP3/WMA files are skipped. This unit may not play files in the order they were recorded in. Refer to your recording software's user's manual for more information.

Compatible Recording Formats

- ISO9660 level 1
- ISO9660 level 2
- Yellow Book MODE 1
- Yellow Book MODE 2 FORM 1
- Multi session
- Maximum files - 999
- Maximum folder levels - 15
- MPEG-1/2 Audio Layer-3

ISO9660 standards:

- Maximum nested folder depth is 8 (including the root folder).
- Valid characters for folder/file names are letters A-Z (all caps), numbers 0-9, and “_” (underscore). Some characters may not be displayed correctly, depending on the character type.
- This device can play back discs in Joliet and other standards that conform to ISO9660. MP3/WMA written in the formats other than the above may not play and/or their file names or folder names may not be displayed properly.



DVD/MP3/WMA Information

Additional MP3/WMA Information

An internal buffer provides ESP (Electronic Skip Protection) to virtually eliminate skipping.

When playing a disc recorded with regular audio files (CD-DA or .WAV) and MP3/WMA files, the unit will play the MP3/WMA files only.

Only MP3 files with filename extension (.mp3) can be played.
Only WMA files with filename extension (.wma) can be played.

Do not attempt to play discs which contain non-MP3/WMA files with the MP3/WMA extension.

Sampling Frequency Rates

MP3 11kHz ~ 48kHz

WMA 44kHz ~ 48kHz

Transfer Bit rates

MP3 32kbps ~ 320kbps constant
Variable bit rates

WMA 64kbps ~ 192 kbps constant
Variable bit rates

Note:

Some files may not play or be displayed correctly, depending on sampling rates and bit rates.

MP3/WMA Tag Display

This model does not display MP3/WMA tag information.

Recommended Settings

For best results, use the following settings when burning an MP3 disc:
128kbps or higher constant bit rate
44.1kHz or higher sampling frequency

For best results, use the following settings when burning a WMA disc:
64kbps or higher constant bit rate
44kHz or higher sampling frequency

Navigation Mode



NAVI Mode

Press **NAVI** icon to select navigation mode. The audio will mute when commands are received from the XNAV9525 navigation system (sold separately). Refer to the XNAV9525 owner's manual for more information.

XNAV9525 operation can be set to integrated or separate. See page 20 for details.

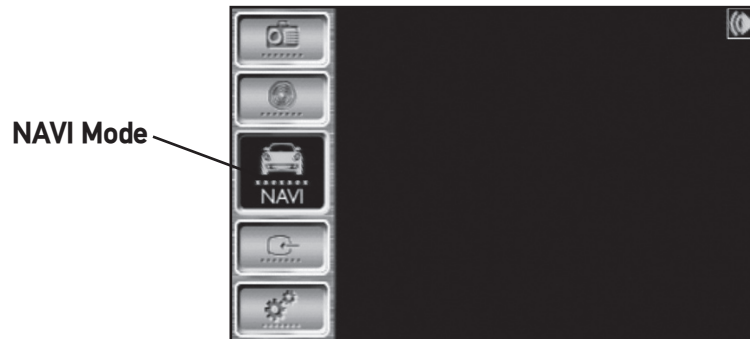

Auxiliary Input Mode



AUX Mode

Press **AUX** icon to select auxiliary input mode.

From the remote control:
Press **AUX 1** or **AUX 2** to select an auxiliary input.

Notes:

The vehicle must be in park and the parking brake applied to view video on the in-dash monitor.

As a safety feature, "WARNING! PICTURE OFF FOR YOUR SAFETY" will show on the display when the vehicle's parking brake is not engaged.

AV1 and AV2 audio can be heard while the vehicle is in motion.

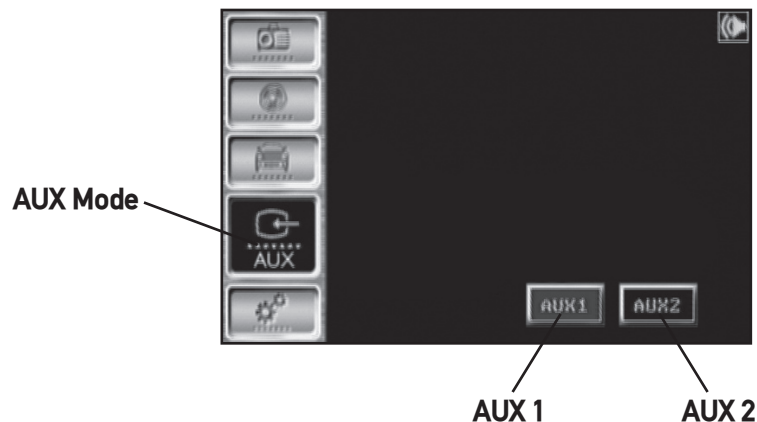



Limited One Year Warranty

This warranty gives you specific legal rights. You may also have other rights which vary from state to state.

Dual Electronics Corp. warrants this product to the original purchaser to be free from defects in material and workmanship for a period of one year from the date of the original purchase.

Dual Electronics Corp. agrees, at our option, during the warranty period, to repair any defect in material or workmanship or to furnish an equal new, renewed or comparable product (whichever is deemed necessary) in exchange without charges, subject to verification of the defect or malfunction and proof of the date of purchase. Subsequent replacement products are warranted for the balance of the original warranty period.

Who is covered? This warranty is extended to the original retail purchaser for products purchased and used in the U.S.A.

What is covered? This warranty covers all defects in material and workmanship in this product. The following are not covered: installation/removal costs, damage resulting from accident, misuse, abuse, neglect, product modification, improper installation, incorrect line voltage, unauthorized repair or failure to follow instructions supplied with the product, or damage occurring during return shipment of the product.

What to do?

1. Before you call for service, check the troubleshooting guide in your owner's manual. A slight adjustment of any custom controls may save you a service call.
2. If you require service during the warranty period, you must carefully pack the product (preferably in the original package) and ship it by prepaid transportation with a copy of the original receipt from the retailer to an authorized service center.
3. Please describe your problem in writing and include your name, a return UPS shipping address (P.O. Box not acceptable), and a daytime phone number with your shipment.
4. For more information and for the location of the nearest authorized service center please contact us by one of the following methods:
 - Call us toll-free at 1-866-382-5476
 - E-mail us at cs@dualav.com

Exclusion of Certain Damages: This warranty is exclusive and in lieu of any and all other warranties, expressed or implied, including without limitation the implied warranties of merchantability and fitness for a particular purpose and any obligation, liability, right, claim or remedy in contract or tort, whether or not arising from the company's negligence, actual or imputed. No person or representative is authorized to assume for the company any other liability in connection with the sale of this product. In no event shall the company be liable for indirect, incidental or consequential damages.

Troubleshooting

Problem	Cause	Action
Unit will not turn on (no power)	Yellow wire not connected or incorrect voltage Red wire not connected or incorrect voltage	Check connections for proper voltage (11~16VDC)
	Black wire not connected	Check connection to ground
	Fuse blown	Replace fuse
Unit has power (but no sound)	Speaker wires not connected	Check connections at speakers
	One or more speaker wires touching each other or touching chassis ground	Insulate all bare speaker wires from each other and chassis ground
Unit blows fuse	Yellow or red wire touching chassis ground	Check for pinched wire
	Speaker wires touching chassis ground	Check for pinched wire
	Incorrect fuse rating	Use fuse with correct rating
Unit has audio (but no video)	Parking brake safety circuit not connected Parking brake not applied	Check connections at parking brake Apply parking brake
	No video display (when in reverse)	Reverse circuit not connected Vehicle is not in reverse
DVD does not start playback	Physical defect in media Parental lock activated Wrong region	Check media for scratches Change the parental lock level. (Default password is 1234.) Use discs labeled "Region 1" or "All" only.
IR remote does not work	Dead battery	Replace battery
Excessive skipping	Unit is not mounted correctly	Check mounting sleeve
	Physical defect in media	Check media for scratches
BAD DISC appears on display	Mechanism error	Press eject or RESET
WRONG DISC appears on display	Focus error or disc is in upside down	Press eject or RESET
REGION ERROR appears on display	Region code error	Use only DVDs labeled "Region 1" or "All" only.

Copyright Notes

This product incorporates copyright protection technology that is protected by method claims of certain U.S. patents and other intellectual property rights owned by Macrovision Corporation and other rights owners. Use of this copyright protection technology must be authorized by Macrovision Corporation, and is intended for home and other limited viewing uses only unless otherwise authorized by Macrovision Corporation. Reverse engineering or disassembly is prohibited.

Manufactured under license from Dolby Laboratories. "Dolby" and the double-D symbol are trademarks of Dolby Laboratories.

Confidential unpublished works. ©1992-1997 Dolby Laboratories, Inc. All rights reserved.

Windows Media and the Windows logo are trademarks, or registered trademarks of Microsoft Corporation in the United States and or other countries.



XDVD8265 OPERATION

Specifications

DVD Player	Frequency response: 10Hz-20kHz Channel separation @ 1kHz: >65dB D/A converter: 24 Bit
FM Tuner	Tuning range: 87.5MHz-107.9MHz Usable sensitivity: 8.5dBf 50dB quieting sensitivity: 10dBf Stereo separation @ 1kHz: 40dB Frequency response: 30Hz-13kHz
AM Tuner	Tuning range: 530kHz-1710kHz Usable sensitivity: 22uV Frequency response: 30Hz-2.2kHz
Monitor	Panel size: 6.5" (165.1 mm) diagonal measurement View angle (up/down/left/right): 40/55/60/60 Resolution: 400 x R.G.B x 234 Brightness (cd/m ²): 500 Contrast ratio: 300:1 Elements: 280.800
General	Operating voltage: 11-16 VDC, negative ground Speaker output impedance: 4~8 ohms Line output voltage: 2 Volts Line output impedance: 200 ohms Chassis dimensions: 7.13" x 6.57" x 4" (181 x 167 x 101 mm) Faceplate dimensions: 6.85" x .67" x 3.85" (174 x 17 x 97.5 mm) Design and specifications subject to change without notice.



CEA-2006 Power Standard Specifications
(reference: 14.4VDC +/- 0.2V, 20Hz~20kHz)

Power Output: 17 Watts RMS x 4 channels at 4 ohms and $\leq 1\%$ THD+N
Signal to Noise Ratio: 80dB (reference: 1 watt into 4 ohms)

Dual Electronics Corp.
Toll Free: 1-866-382-5476

www.dualav.com
©2006 Dual Electronics Corp. All rights reserved.
NSA0206-V01

Free Manuals Download Website

<http://myh66.com>

<http://usermanuals.us>

<http://www.somanuals.com>

<http://www.4manuals.cc>

<http://www.manual-lib.com>

<http://www.404manual.com>

<http://www.luxmanual.com>

<http://aubethermostatmanual.com>

Golf course search by state

<http://golfingnear.com>

Email search by domain

<http://emailbydomain.com>

Auto manuals search

<http://auto.somanuals.com>

TV manuals search

<http://tv.somanuals.com>