



XDMA6540

INSTALLATION/OWNER'S MANUAL

AM/FM/CD Receiver



Preparation

Please read entire manual before installation.

Before You Start

- Disconnect negative battery terminal. Consult a qualified technician for instructions.
- Avoid installing the unit where it would be subject to high temperatures, such as from direct sunlight, or where it would be subject to dust, dirt or excessive vibration.

Getting Started

- Remove trim ring from unit.
- Insert the supplied keys into the slots as shown, and slide the unit out of the mounting sleeve.
- Install mounting sleeve into opening, bending tabs to secure.
- Connect wiring harness and antenna. Consult a qualified technician if you are unsure.
- Certain vehicles may require an installation kit and/or wiring harness adapter (sold separately).
- Test for correct operation and slide into mounting sleeve to secure.
- Snap trim ring into place.

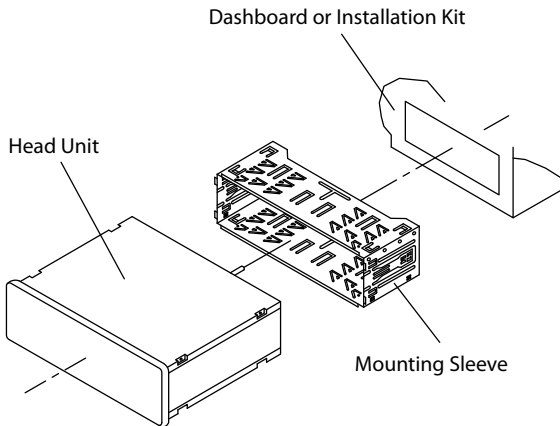
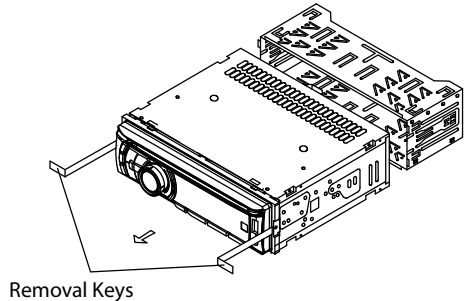

TYPICAL FRONT-LOAD DIN MOUNTING METHOD

Wiring Diagram

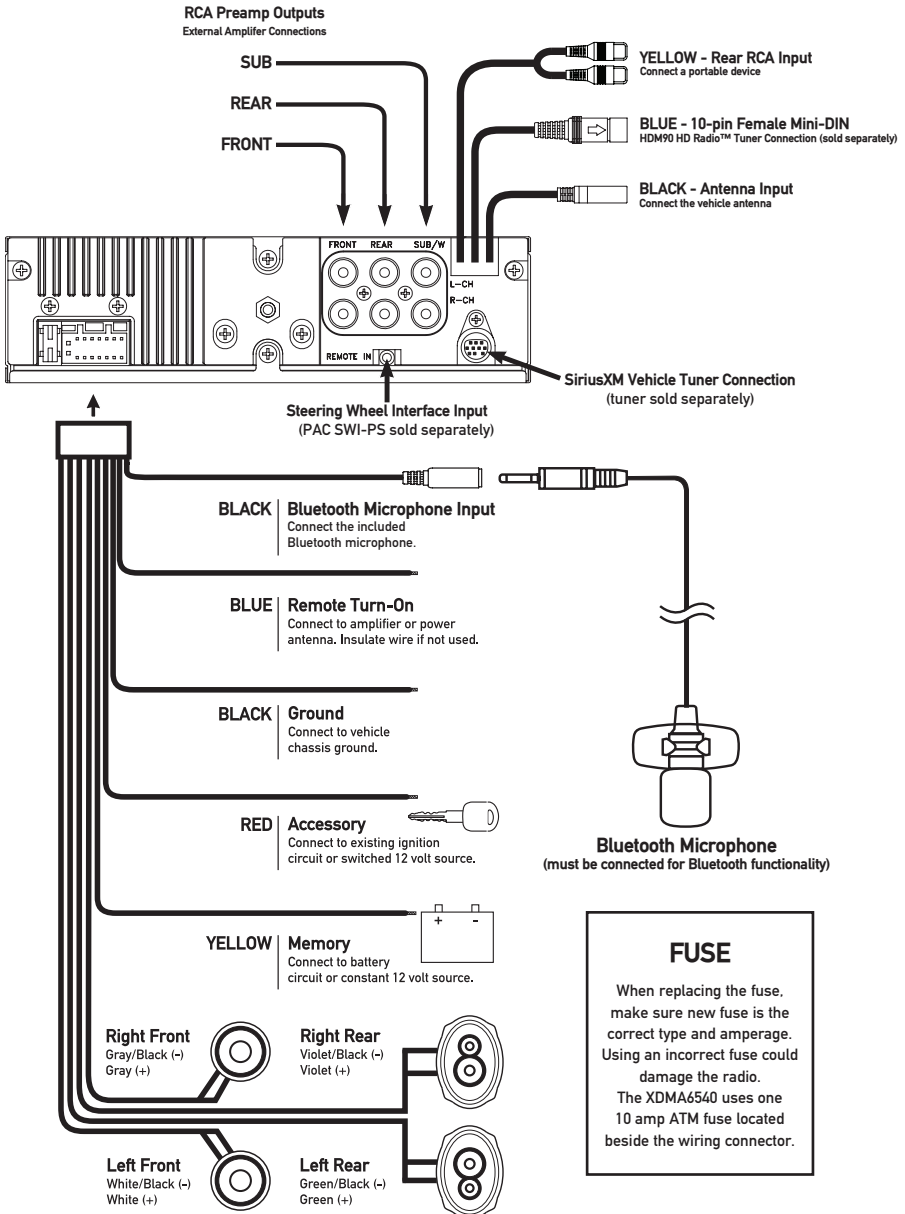

Control Locations - Receiver

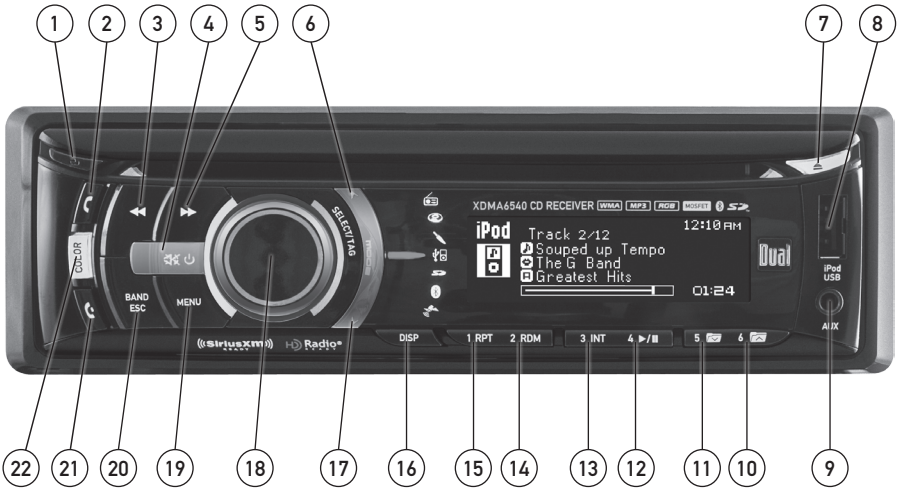

- | | |
|--------------------------|-----------------------------|
| ① Release | ⑫ Preset 4 / Play / Pause |
| ② Bluetooth Talk | ⑬ Preset 3 / Intro |
| ③ Tune / Track Down | ⑭ Preset 2 / Random |
| ④ Mute / Power | ⑮ Preset 1 / Repeat |
| ⑤ Tune / Track Up | ⑯ Display |
| ⑥ Mode Up | ⑰ Mode Down |
| ⑦ CD Eject | ⑱ Volume knob / Select/ Tag |
| ⑧ USB Port | ⑲ Menu |
| ⑨ Auxiliary Input | ⑳ Band / Escape |
| ⑩ Preset 6 / Folder Up | ㉑ Bluetooth End Call |
| ⑪ Preset 5 / Folder Down | ㉒ Color |

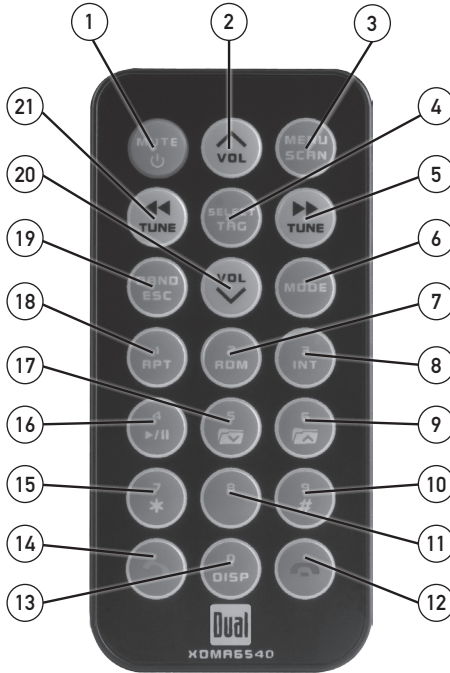

Control Locations - Remote



- | | |
|------------------------|---------------------------|
| ① Mute / Power | ⑫ Bluetooth End Call |
| ② Volume Up | ⑬ Key 0 / Display |
| ③ Menu / Scan | ⑭ Bluetooth Talk |
| ④ Select / Tag | ⑮ Key 7 / Key * |
| ⑤ Tune / Track Up | ⑯ Preset 4 / Play / Pause |
| ⑥ Mode | ⑰ Preset 5 / Folder Down |
| ⑦ Preset 2 / Random | ⑱ Preset 1 / Repeat |
| ⑧ Preset 3 / Intro | ⑲ Band / Escape |
| ⑨ Preset 6 / Folder Up | ⑳ Volume Down |
| ⑩ Key 9 / Key # | ㉑ Tune / Track Down |
| ⑪ Key 8 | |

General Operation

Power On/Off

Press  or any other button to turn unit on. Press and hold  to turn unit off.

Faceplate Removal

Press **RELEASE** and pull away from the left side to remove. To re-install, insert right side of faceplate first then push left side to secure.

Semi-permanent Faceplate Installation

Remove trim ring and install supplied #1 x 7/32" Phillips head screw through left side of mounting frame into faceplate.

Changing Modes

Press **MODE DOWN** to cycle down or press **MODE UP** to cycle up through the below operating modes. A mode indicator located to the left of the LCD will point to the current mode of operation.



AM/FM Tuner Mode



CD Player Mode



Auxiliary Input (front/rear) Modes



USB and Operation of iPod®/iPhone® Modes



SD Card Mode



Bluetooth Mode



SiriusXM Satellite Radio Mode

Available Modes

SiriusXM mode will not appear unless the SiriusXM Connect Vehicle Tuner (sold separately) is connected.

Operation of iPod mode will not appear unless an iPod device (sold separately) has been connected.

CD, USB and SD modes will not appear unless a CD, USB device or SD card (sold separately) have been connected.

HD Radio™ mode will replace AM/FM tuner mode when the Dual HDM90 HD Radio tuner (sold separately) is connected.



General Operation

Volume	Adjust volume using volume knob (00-46).
Mute	Press MUTE to silence the audio. "MUTE" will flash in the display. Press MUTE again to cancel.
Display	Press DISP to toggle between items such as ID3 tag song information, file/folder information or the clock.
Select / Tag	Push the volume knob inward to activate the SELECT function. Push and hold the volume knob inward to activate the TAG function.
Steering Wheel Interface Input	<p>The steering wheel interface input located on the back of the head unit allows connection to the PAC (Pacific Accessory Corporation) SWI-PS interface module (sold separately). Visit www.pac-audio.com for details.</p> <p>To configure steering wheel controls, follow the instructions provided with the PAC SWI-PS interface module. After installing the interface module, insert the module's 3.5mm jack into the port labeled "REMOTE IN" on the back of the head unit.</p>
Auxiliary Inputs	The XDMA6540 features two auxiliary inputs. Insert a 3.5mm connector in the front panel AUX port, or connect RCA-type cables into the rear AUX port. Press MODE UP/DOWN to select Aux Front or Aux Rear modes.
Reset	Press the RESET button, located behind the front panel, to reset the unit back to the factory settings if abnormal operation occurs.
Setting the Clock	<p>With the unit on, press and hold DISP until the clock begins to flash, then release. Press TUNE ◀◀ to adjust the hours and TUNE ▶▶ to adjust the minutes. Press DISP momentarily to save the selected time.</p> <p>Note: The clock can also be set in the GENERAL menu. See page 11 for details.</p>
12/24-Hour Clock	<p>The clock will display 12-hour AM/PM time in USA frequency spacing mode (PM 10:00). In European frequency spacing mode, the clock will display 24-hour time (22:00).</p> <p>Note: 24-hour time and European frequency spacing are not available if the HDM90 HD Radio™ tuner are connected.</p>

Setup Menu

Press **MENU** to access the setup menu, then turn the volume knob to cycle through menu categories: **Audio, Color, Display, Tuner, iPod, Bluetooth, SiriusXM and General.**

- When desired category appears in the display, press **SELECT**, then rotate the **volume knob** left/right to cycle through the options in each category.
- When desired option appears in the display, press **SELECT**, then rotate the **volume knob** left/right to adjust or activate desired function. **Note:** Some functions are toggled by pressing **SELECT** and may not require turning the volume knob.
- Press **ESC** to return to the previous menu, or exit the menu while the main menu is displayed.

Audio Menu

Function	Options	Action
Bass	Level	Adjust the bass frequency output from -6 to +6.
Treble	Level	Adjust the treble frequency output from -6 to +6.
Balance	Left - Right	Shift the speaker output from the left (-12) to the right (+12).
Fader	Front - Rear	Shift the speaker output from the front (-12) to the rear (+12).
Equalizer	Preset EQs	Select between Flat, Pop, Jazz, Classic, Beat, Rock, User. • Any Bass or Treble adjustments are saved as the "User" EQ.
Subwoofer	Level	Adjust the level of the subwoofer output from 0 (off) to +12.
Loudness	Off/On	Set the loud setting to On or Off. • Enhances the bass and treble frequencies at low volumes.
Source Level	-6 to +6	Adjusts the output level for each mode individually from -6 to +6.

Color Menu

Menu Function	Options
Auto Change	Sets the unit to rotate between all illumination colors automatically. Setting a preset or user color will cancel the automatic color change.
Set Color	Adjust the color of the button and LCD illumination between 31 preset colors. <ul style="list-style-type: none"> • Off: sets the color to white. (default) • Day/Night: sets the color to change to different colors during the day or night. The day and night colors must be set in the Day/Night color menu below. • User: sets the color to the custom color. The custom color must be set in the menu below. • 1-31: choose from any of the 31 preset colors.
Set Custom Color	Individually select the level of Red, Green and Blue from 1 - 32. Any combination of these colors can be selected. Important Note: Setting each Red, Green and Blue levels to 1 will turn off set turn off the illumination for the LCD and buttons. If this color is set, press COLOR to change to a color.
Set Day/Night Color	Sets individual colors for the day or night. (The clock must be set for proper function). <ul style="list-style-type: none"> • Day Color: sets the daytime color to a preset or custom color. • Night Color: sets the nighttime color to a preset or custom color. • Time: adjusts the night time span. Turn the volume knob to adjust. (default is 7pm to 7am).



Setup Menu

Display Menu

Menu Function	Options
Scrolling	Changes the scrolling style used for displayed information on the LCD between: <ul style="list-style-type: none"> • Off: information will not scroll. • Once: information will scroll one time per song. • 15 seconds: information will scroll once per 15 seconds. • Page: information will cycle instead of scrolling. (default) • On: information will constantly scroll.
Dimmer	Adjusts the illumination level for the buttons and LCD between: <ul style="list-style-type: none"> • High: brightest illumination level. (default) • Medium: middle illumination level. • Low: dimmest illumination level. • NA: illumination level is locked and cannot be changed when day/night color is enabled.
LCD Type	Sets the LCD illumination type <ul style="list-style-type: none"> • Positive: Color background with black text. • Negative: Black background with color text. • Automatic: Switches to positive during the daytime, and negative during the night. (default)

Tuner Menu

Menu Function	Options
Auto Station Store	Press SELECT to begin storing strong radio stations to the 1 - 6 preset buttons in the current band.
Local	Allow only strong radio stations to be received, blocking stations with weak signal.
Frequency Sp.	Changes the tuner to receive USA (default) or European radio frequencies.
Tune/Seek Priority	Switches the function of the seek/tune up and down buttons: <ul style="list-style-type: none"> • Seek: Quick press will seek to the next strong channel. Press and hold to activate manual tuning. • Tune: Quick press will manually tune to the next station. Press and hold to seek to the next strong channel. (default)

HD Radio™ Tuner Menu

When the optional HDM90 HD Radio tuner (sold separately) is connected, the following additional menu options will appear in the Tuner menu.

Menu Function	Options
HD Seek	Limits the seek and auto station store functions to only access HD Radio channels. <ul style="list-style-type: none"> • On: Seek and Auto Station Store will only access digital HD Radio channels. • Off: All analog and digital channels will be accessed. (default)
Delete All Tags	Press SELECT to erase all Tags that are saved in memory. (Does not affect Tags that have been transferred to an iPod device.)
Tuner Mode	Enables/disables the digital HD Radio channel reception. <ul style="list-style-type: none"> • Analog: Limits the reception to standard analog channels only. • Digital: Allows both digital and analog channels to be received. (default)



Setup Menu

iPod Menu

Menu Function	Options
iPod Control	Switches the control between the head unit and the iPod/iPhone device. <ul style="list-style-type: none">• Full: Enables total control of the iPod device from the XDMA6540. (default)• Manual: Releases the control of the iPod device. Music searches and track selections must be done from the device. The iPod device will continue to charge.

Bluetooth™ Menu

Menu Function	Options
Bluetooth	Enables/disables Bluetooth functionality.
Auto Answer	Answers all incoming calls automatically without requiring a button press. <ul style="list-style-type: none">• On: Automatically accepts all incoming calls after 2-3 rings without pressing the TALK button.• Off: Incoming calls can be accepted by pressing the TALK button, or refused by pressing the END button. (default)
Auto Connect	Connects the most recently paired Bluetooth device automatically. <ul style="list-style-type: none">• On: Connects automatically when the XDMA6540 is powered on and the Bluetooth device is in range. (default)• Off: Will not connect to any Bluetooth device unless you manually select the device from the "paired devices" menu.
Speaker Output	Directs the Bluetooth audio to only the front speakers (default) or to all four speakers.

SiriusXM Tuner Menu

When the optional SiriusXM Satellite Radio tuner (sold separately) is connected, the following additional menu options will appear in the Setup Menu.

Menu Function	Options
Parental Control (default code: 0000)	Press SELECT to enter the Parental Control menu. This menu is locked by a 4 digit code, and a prompt will appear to enter the code. Unless changed using the Edit Code menu (see below), the default code is "0000". Enter this code using one of these two methods: <ul style="list-style-type: none">• Enter "0000" using the remote control, by pressing the numbers directly. Press SELECT to confirm.• Turn the volume knob to select the first digit, then press SELECT. Continue with the remaining digits until the code is entered.
	Once the code is entered, choose from the below menu options:
	Edit Code: Choose this option to program a new 4-digit code. Enter the new code using the input method described above.
	Channel Lock: Once selected, the channel list will appear. Turn the volume knob to cycle through the list of channels. Press SELECT to lock the desired channel; a locked channel will not be available in the channel lineup. A lock icon will appear next to the channel name when the channel is locked. Pressing SELECT on a locked channel will unlock it.
	Clear All: Choose this option to reset the locked channels back to the factory default. All currently subscribed channels will be unlocked.
Delete All Tags	Press SELECT to erase all Tags that are saved in memory. (Does not affect Tags that have been transferred to an iPod device.)



Setup Menu

General Menu

Menu Function	Options
Clock	Enables/disables the clock to be displayed on the LCD when the XDMA6540 is powered off using the power button.
Aux Front	Enables/disables the 3.5mm auxiliary input on the front panel. <ul style="list-style-type: none"> • On: The auxiliary input is enabled. (default) • Off: Auxiliary input mode is removed from the list of available modes.
Aux Rear	Enables/disables the RCA auxiliary input located behind the head unit. <ul style="list-style-type: none"> • On: The auxiliary input is enabled. (default) • Off: Auxiliary input mode is removed from the list of available modes.
Beep	When enabled, every button press will output a beep tone. <ul style="list-style-type: none"> • On: Every button press will output a single beep tone. • Off: Only press-and-hold button functions will output a double beep tone. (default)
Prog. Volume	Sets the XDMA6540 to power-on to the same volume level every time. <ul style="list-style-type: none"> • Off: The unit will turn on at the last volume level that was set. (default) • 1-30: Choosing a volume level will program the unit to always turn on at that volume.
Power-on Message	Allows the "Good Morning/Afternoon/Evening" message that may be shown when the unit is powered on.
Demo mode	Enables/disables the demonstration mode for display purposes.
Set Clock	Adjusts the time for the internal clock. <ul style="list-style-type: none"> • Press ◀◀ to adjust the hours. • Press ▶▶ to adjust the minutes.

AM/FM Tuner Operation

Display	Press DISP to toggle the display between the frequency and clock. Note: when using the HDM90 HD Radio™ tuner, refer to page 12.
Seek Tuning	Press TUNE ◀◀ or TUNE ▶▶ for more than one second to seek the next strong station.
Manual Tuning	Press TUNE ◀◀ or TUNE ▶▶ momentarily to move radio frequency up or down one step at a time. Press and hold to advance quickly. Note: Tuning options can be changed in the tuner setup menu.
Scan Tuning	Press SCAN on the remote control momentarily to preview strong stations on the current band, pausing for five seconds at each. Press SCAN on the remote control again to cancel.
Band	Press BAND to select between FM1, FM2, FM3, AM1 and AM2 bands. Up to six presets can be programmed for each band.
Storing and Recalling Station Presets	Up to 18 FM stations and 12 AM stations can be stored in memory. To store a station, select the desired band and station. Press and hold the desired preset button (1-6) for more than two seconds. When stored, the preset number will appear in the display. The station can be recalled by pressing the corresponding preset button.



HD Radio™ AM/FM Tuner Operation

**Connecting the HDM90
(sold separately)**

HD Radio operation requires connecting the HDM90 HD Radio tuner (sold separately). Refer to the HDM90 instructions for connection details.

Display

When the unit is tuned to an HD Radio station, press **DISP** to toggle the display between artist/title and program type/station name.

HD Radio Tuning

Seek, manual and scan tuning functions are performed as described for AM/FM tuning on page 11.

When HD Radio station is selected, an HD Radio logo will begin to flash on the display. After about five seconds, HD or HD1 will illuminate after the radio frequency.

- If "HD" appears, the radio station is broadcasting a higher quality sound. No additional stations are available.
- If "HD1" appears, additional multicast channels (HD2 and/or HD3) are available. Press **TUNE ►►** to tune to other available multicast channels.

HD Seek Mode

To activate HD Seek, refer to the HD Radio setup menu on page 9. Once enabled, the HD SEEK icon will appear on the display, indicating that the unit will skip over analog stations and tune to HD Radio stations only.

Select "HD Seek Off" from the HD Radio menu to cancel.

Auto Station Store

While in HD SEEK mode, the AUTO STORE menu option will automatically store only HD Radio stations, beginning from the lowest frequency.

Note: Multicast channels (HD2 and/or HD3) are not automatically stored with this feature but can be stored by holding the desired preset number (1-6) for 3 seconds.

Setting HD Radio Presets

HD Radio multicast stations (HD2 and HD3) can be stored as presets in the same way as analog radio stations. Press and hold a preset button until it beeps to store the preset.

**Recalling an HD Radio
Multicast Preset**

When selecting a preset multicast station, "LINKING" will appear in the display for approximately 5 seconds while the multicast station information is received.

Note: If the HD Radio signal on the preset is unavailable, the unit reverts to the previous analog or digital station.



SiriusXM Vehicle Tuner Connections

Connecting the SiriusXM Vehicle Tuner (sold separately)

SiriusXM Satellite Radio operation requires the connection of the SiriusXM-Connect Vehicle Tuner (sold separately).

Note: The SiriusXM-Connect Vehicle Tuner must have the SiriusXM logo to be compatible with the XDMA6540.

To connect the SiriusXM Vehicle Tuner, follow the instructions provided with the tuner. When connecting the tuner to the XDMA6540, the cable orientation should be connected as shown below.

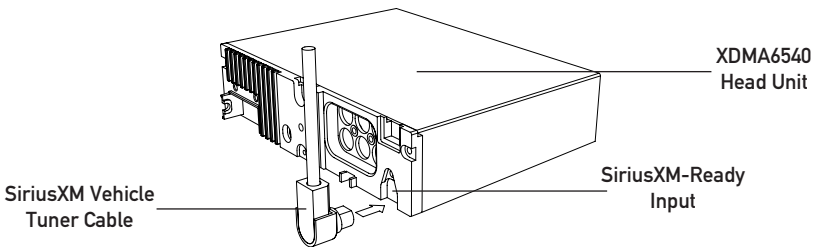

Line up the connector with the pins on the cable. It can only be inserted as shown above. Push the cable into the head unit's connector until it clicks. Attempting to insert the cable differently from shown above may cause damage to the cable or head unit.

SiriusXM Vehicle Tuner Operation

SiriusXM Satellite Radio Overview

Everything worth listening to is on SiriusXM, getting over 130 channels, including the most commercial-free music, plus the best sports, news, talk and entertainment. A SiriusXM Vehicle Tuner (sold separately) and Subscription are required. For more information, visit www.siriusxm.com.

Sirius, XM and all related marks and logos are trademarks of Sirius XM Radio Inc. and its subsidiaries. All other marks and logos are the property of their respective owners. All rights reserved.

Listening to SiriusXM Satellite Radio

After installation of the SiriusXM Vehicle Tuner, press **SOURCE** until SiriusXM mode appears to begin listening to SiriusXM Satellite Radio.

Tuner Activation

To listen to SiriusXM Satellite Radio, a subscription is required. Activate the SiriusXM Vehicle Tuner using one of the two methods below:

- **Online:** Go to www.siriusxm.com and choose **ACTIVATE RADIO**.
- **Phone:** Call 1-800-XM-RADIO (1-800-967-2346).

Activation typically takes 10-15 minutes, but may take up to an hour. It is recommended to leave your vehicle on until the "Subscription Updated" message appears.

Radio ID

To view the Radio ID on the LCD, press **TUNE** ◀◀ or **TUNE** ▶▶ until channel 0 appears. The 8 character Radio ID will appear on the display. The Radio ID is also printed on the underside of the SiriusXM Vehicle Tuner. **Note:** The Radio ID does not use the letters I, O, S, F.



SiriusXM Vehicle Tuner Operation

Changing Channels	<p>Press TUNE ◀◀ or TUNE ▶▶ to select the next channel up or down.</p> <p>Hold down TUNE ◀◀ or TUNE ▶▶ to quickly change channels. Release the button to stop on the desired channel.</p>
Band	<p>Press BAND to select between the SXM1, SXM2 and SXM3 bands. Up to six presets can be programmed for each band.</p>
Presets	<p>Up to 18 SiriusXM Satellite Radio channels can be stored in memory. To store a channel, select the desired band and channel. Press and hold the desired preset button (1-6) on the front panel or remote control for more than two seconds. When stored, the preset number will appear in the display. The channel can be recalled by pressing the corresponding preset button.</p> <p>Note: Buttons 7,8,9,0 on the remote control are not associated with channel presets.</p>
Parental Control	<p>See the SiriusXM setup menu on page 10 for parental control instructions.</p>

Channel Search

Begin Your Search	<p>Press SELECT to start searching for a specific channel. Choose between Channel List, Category Search or Direct Channel Input.</p>
Channel List	<p>Displays a list of all available channels.</p> <ul style="list-style-type: none">• Highlight "Channel List" and press SELECT.• Turn the volume knob to cycle through the list of channels.• Press DISP to change between the channel name and the currently playing artist or song title.• Press SELECT to begin listening to the highlighted channel.
Category Search	<p>Searches for channels in a certain category.</p> <ul style="list-style-type: none">• Highlight "Category Search" and press SELECT.• Turn the volume knob to cycle through the list of categories.• Press SELECT to choose a category and display the channels in that category.• Press DISP to change between the channel name and the currently playing artist or song title.• Press SELECT to begin listening to the highlighted channel.
Direct Channel Input	<p>Input a channel number to directly tune to that channel.</p> <ul style="list-style-type: none">• Highlight "Direct Channel Input" and press SELECT.• Use one of the two methods below to enter the channel number:<ol style="list-style-type: none">1) Enter the 1, 2 or 3-digit channel number using the remote control 0-9 keys and press SELECT. Press ESC to delete a digit.2) Use the unit volume knob to select 0-9 for the number digits. If applicable, use TUNE ▶▶ to advance to the next digit and press SELECT to tune to the entered channel. Press ESC or TUNE ◀◀ to delete a digit. <p>Example: To tune to channel 12, select "1" using the volume knob, press TUNE ▶▶ to advance, then select "2" with the volume knob and press SELECT.</p>



SiriusXM Vehicle Tuner Operation

Displayed Information

- | | |
|---|---|
| <p>Display</p> <p>Channel Name Icon </p> <p>Artist Name Icon </p> <p>Song Title Icon </p> <p>Category Icon </p> <p>Content Info Icon </p> | <p>Press DISP to cycle between: Channel Name/Artist Name/Song Title → Category Name/Artist Name/Song Title → Artist Name/Song Title/Content Info → Clock.</p> <p>Displays the name of the SiriusXM channel.</p> <p>Displays the artist's name from the currently playing song.</p> <p>Displays the song title from the currently playing song.</p> <p>Displays the category type of the current channel.</p> <p>Displays special channel information from the current channel.</p> |
|---|---|

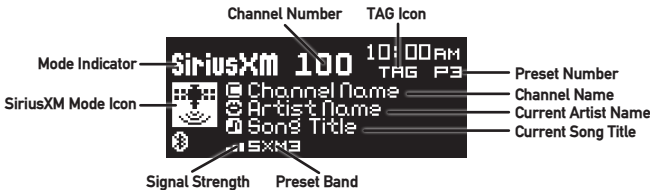

Default display layout for SiriusXM mode

SiriusXM Advisory Messages

Message	Description
Check Tuner	<ul style="list-style-type: none"> Check the SiriusXM tuner connection behind the XDMA6540 to ensure that its correctly connected.
Check Antenna	<ul style="list-style-type: none"> Ensure the SiriusXM antenna cable is connected to the SiriusXM tuner correctly. Check the SiriusXM antenna wire for breaks or sharp bends. Replace the antenna if necessary. Press RESET located behind the front panel. If the message remains, the antenna may have been damaged.
No Signal	<ul style="list-style-type: none"> The vehicle must be outside, and the antenna must have a clear view of the southern sky. The magnetic antenna must be mounted on the outside of the vehicle for the best reception.
Channel Not Subscribed	<ul style="list-style-type: none"> This channel is not included in your SiriusXM subscription plan. Call 1-800-XM-RADIO (1-800-967-2346) to subscribe.
Channel Not Available	<ul style="list-style-type: none"> This channel is not a valid SiriusXM channel. The channel number has been entered incorrectly, or the channel was removed from the SiriusXM channel lineup. The XDMA6540 will resume SiriusXM channel 1.
Channel Locked	<ul style="list-style-type: none"> The selected channel has been locked by the parental control option. A prompt to enter the unlock code will appear. Enter the unlock code as described on page 10.
Subscription Updated	<ul style="list-style-type: none"> An update to your SiriusXM subscription has been received by the SiriusXM tuner. Press any key to continue.



iTunes® Tagging Operation

Requirements	The iTunes Tagging feature of the XDMA6540 requires the optional HDM90 HD Radio™ tuner (sold separately) or SiriusXM Vehicle Tuner (sold separately).
Overview	iTunes Tagging allows the user to "Tag" songs that are playing on an HD Radio station or SiriusXM Satellite Radio channel and enables them to be purchased later through iTunes. With the touch of a button the unit will remember the title and artist song information, and then transfer that information to your iPod device the next time you connect it to the XDMA6540. A new list called "Tagged" will appear in iTunes, giving you the option to purchase each song.

Tagging Music

Step 1	Tune to an HD Radio station or SiriusXM channel. The TAG icon must appear, indicating that a valid artist name and song title are available.
Step 2	Press and hold the SELECT/TAG button. A confirmation will be displayed, indicating that the song information has been saved. The song information will be saved in memory until an iPod device is plugged in. Up to 64 HD Radio Tags and 64 SiriusXM Tags can be saved before they must be transferred or deleted.
Step 3	Plug in an iPod device. All the Tags currently in memory will be automatically transferred, deleting the Tags from the head unit's memory. See page 25 for connection details. Note: The XDMA6540 must remain in HD Radio tuner, SiriusXM or operation of iPod modes until the Tags are successfully transferred. Tags cannot be transferred from SD Card, USB, Bluetooth or Auxiliary input modes. If an iPod device is plugged in when a song is tagged, press MODE UP/DOWN until the XDMA6540 is in operation of iPod mode. Tags will transfer automatically. (see page 17 for compatibility with iPod devices).
Step 4	Sync with iTunes. A list named "Tagged" will appear on the left in the iTunes software. Click on the "Tagged" list to view all the songs that have been tagged and click the "view" button for purchase information.
Deleting All Tags	Press MENU to enter the setup menu. Select the HD Radio or SiriusXM menu, and select the "Delete Tags" option. HD Radio Tags and SiriusXM Tags are saved separately, and must be deleted separately. See pages 9-10 for details. Note: Once transferred, Tags are managed from the iTunes software.



iTunes® Tagging Operation

Troubleshooting

Displayed Message	Description
Check iPod Version	There is a compatibility issue with the iPod device that is connected. Check the list of compatible iPod devices below. If the attached iPod device is compatible, update the firmware to the latest version using iTunes.
Sending Tags	Tags are being sent to the iPod device. This process can take several minutes depending on the number of Tags being sent.
iPod Device is Full	There is not enough space on the connected iPod device to transfer the iTunes Tags. Free up space using iTunes.
Tag Transfer Failed	Connection error. Ensure the iPod device is powered on and reconnect the iPod device until a confirmation is displayed.
Song Already Tagged	The same song has already been tagged from the same radio station, and is currently saved in memory. The same song cannot be tagged twice - unless the song is tagged on a different radio station, the Tags are sent to an iPod device or the tags are erased.
Internal Memory Full - Connect iPod	The internal memory will hold 64 HD Radio™ Tags and 64 SiriusXM Tags. An iPod device must be connected to transfer the Tags, or the Tags must be deleted before more songs can be tagged.
No Tag Information	There is not sufficient information (artist or title) to tag the song. Some HD Radio stations or SiriusXM channels or certain songs may not fully support iTunes Tagging.
Tagging Failed Try Again	There was an error saving the Tag information to the internal memory. Press and hold the SELECT/TAG button again.
No Tags Stored	There are no tags saved in the internal memory. The Delete Tags function can only delete Tags that are saved in the internal memory.

Device Compatibility with iTunes Tagging

- Compatible with
- *iPod touch (4th generation)
 - iPod nano (6th generation)
 - *iPod touch (3rd generation)
 - iPod nano (5th generation)
 - *iPod touch (2nd generation)
 - iPod nano (4th generation)
 - iPod classic
 - *iPod touch (1st generation)
 - iPod nano (3rd generation)
 - *iPhone 4
 - *iPhone 3GS
 - *iPhone 3G
 - *iPhone

*Some iPod devices may require you to select 'transfer purchases' in the context menu from the name of your iPod device to transfer Tags to iTunes.

Go to www.apple.com/itunes for the latest version of the iTunes software.



CD Player Operation

Insert CD	With the label facing up, insert a standard size CD into the CD slot. The CD will automatically begin playback.
Eject CD	Press EJECT to eject the CD. The unit will change to previous mode of operation. If the disc is not removed within 10 seconds, the unit will reload the disc. The unit does not have to be turned on to eject CD.
Track Select	Press TRACK ►► to skip to the beginning of the next track. Press TRACK ◀◀ to return to the beginning of the current track. Pressing TRACK ◀◀ again skips to the beginning of the previous track.
Fast Forward/Reverse	Press and hold TRACK ►► or TRACK ◀◀ to fast forward or reverse a track.
Pause	Press ►/ to temporarily stop CD playback. Press ►/ again to resume playback.
Intro	Press INT to enter the Intro menu, then turn the volume knob to select one of the following options: <ul style="list-style-type: none">• OFF - Cancels the INT function.• ALL SONGS - Plays the first 10 seconds of each track.
Repeat	Press RPT to enter the Repeat menu, then turn the volume knob to select one of the following options: <ul style="list-style-type: none">• ALL SONGS - Plays all tracks on CD.• CURRENT SONG - Continuously repeats selected track.
Random	Press RDM to enter the Random menu, then turn the volume knob to select one of the following options: <ul style="list-style-type: none">• OFF - Cancels the RDM function.• ALL SONGS - Plays all tracks in random order.
CD-R/CD-RW Compatibility	<p>Some CD-Rs and CD-RWs may be incompatible with this unit, depending on media type and recording method. In addition, the following CDs may be incompatible with this unit:</p> <p>CDs exposed to extreme temperatures or direct sunlight for extended periods of time. CDs recorded in which a recording session failed or a re-recording was attempted and, or encrypted or copy-protected CDs which do not conform to the audio CD-DA red book recording standard.</p>



CD Player Operation - MP3/WMA

<p>Playing an MP3/WMA Disc</p>	<p>When an MP3/WMA encoded disc is first inserted, "READING" will appear in the display. Depending on the number of files and folders, this may take several seconds.</p>
<p>Folder Access</p>	<p>Press to select the next folder. Press to select the previous folder.</p> <p>*Folder access is only available on discs recorded with more than one folder.</p>
<p>Repeat</p>	<p>Press RPT to enter the Repeat menu, then turn the volume knob to select one of the following options:</p> <ul style="list-style-type: none"> • All Songs - Plays all tracks on CD. • Current Song - Continuously repeats selected track. • Current Folder - Continuously repeats all files in the folder.
<p>Random</p>	<p>Press RDM to enter the Random menu, then turn the volume knob to select one of the following options:</p> <ul style="list-style-type: none"> • Off - Cancels the RDM function. • All Songs - Plays all tracks in random order. • Current Folder - Plays all tracks in the folder in random order. <p>Note: Random mode is retained in memory when selecting between other modes and when the unit is turned on/off.</p>
<p>Intro</p>	<p>Press INT to enter the Intro menu, then turn the volume knob to select one of the following options:</p> <ul style="list-style-type: none"> • Off - Cancels the INT function. • All Songs - Plays first 10 seconds of each track. • Current Folder - Plays first 10 seconds of each track in folder. <p>Note: Folder repeat, random and intro options only function on MP3/WMA discs recorded with more than one folder.</p>

CD Player Operation - MP3/WMA

Displayed Information

Press **DISP** to select between displayed information such as ID3 tag information and file/folder names.

Display layout for MP3/WMA CD's

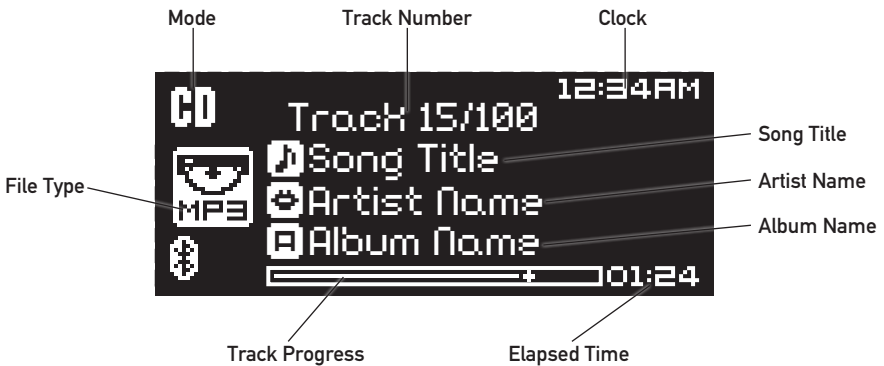

File/Folder Search

Begin Searching	Press SELECT to enter the file/folder search mode. A list of all the folders from the CD will be displayed. Note: Any files located in the root directory will be located in the folder named "ROOT".
Choose a song	Turn the volume knob to cycle through all the folders on the disc and press SELECT to choose the desired folder. The list of files in the selected folder will be displayed. Turn the volume knob to cycle through the list of files.
Menu Navigation	Pressing ESC when viewing the contents of a folder will return to the list of folders. Press ESC again to exit the search menu.
Playing a song	Once the desired song is displayed, press SELECT to begin playback of the desired song.

CD Player Operation - MP3/WMA

File/Folder Search (continued)

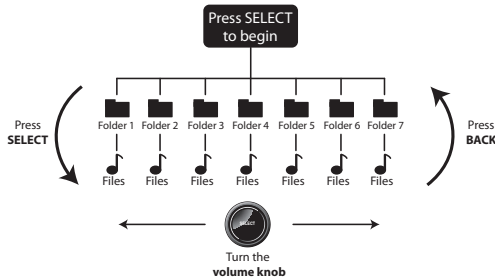

File/Folder Compatibility and Support

Compatible File Types	<ul style="list-style-type: none"> • CD-ROM (ISO), CD-R, CD-RW • CD-DA (digital audio) • MP3 data (.mp3) • WMA data (.wma)
Incompatible File Types	<ul style="list-style-type: none"> • DRM protected files • WMA lossless • Apple lossless • WMA Pro • MP3 Pro • MP3 playlists • WAV lossless • M4A/AAC files
Recording Format Compatibility	<ul style="list-style-type: none"> • ISO9660 level 1 & level 2 • Yellow book MODE 1 & MODE 2 FORM 1 • Multi session
Sampling Frequency Rate Compatibility	<ul style="list-style-type: none"> • MP3: 8kHz - 48kHz • WMA: 32kHz - 48kHz
Transfer Bit Rate Compatibility	<ul style="list-style-type: none"> • MP3: 32kbps - 320kbps • WMA: 32kbps - 192kbps
Character Support	<ul style="list-style-type: none"> • Song Title: 32 characters • Artist Name: 32 characters • Album Name: 32 characters • File Name: 32 characters • Folder Name: 32 characters
ID3 Tag Support	<ul style="list-style-type: none"> • MP3 Tags: Version 1.0 - 2.4 • WMA Tags
File/Folder Limit	<ul style="list-style-type: none"> • Maximum files: 999 • Maximum folders: 255 • Maximum folder levels: 8



USB/SD Card Operation

Connect a USB Device (sold separately)	To play MP3/WMA files from most mass storage devices, connect a device to the XDMA6540's USB port.
Connect an SD Card (sold separately)	To play MP3/WMA files from an SD Card, insert an SD card into the XDMA6540's SD card slot, located behind the front panel. Insert the SD card with the label facing up, and press the card until it clicks into place. Remove the SD card by pressing in until it clicks, then pull to remove.
Playing Music	When a USB or SD card device is first connected, playback will begin momentarily. Depending on the number of files and folders, it may take several seconds for the device to begin playing. If no valid MP3/WMA files are detected, "NO FILE" will be displayed and the last mode will be resumed.
Track Select	Press ▶▶ to skip to the beginning of the next song. Press ◀◀ to return to the beginning of the current song. Pressing ◀◀ again skips to the beginning of the previous song.
Fast Forward and Reverse	Press and hold TRACK ▶▶▶ or TRACK ◀◀◀ to fast forward or reverse a track.
Pause	Press ▶/ to temporarily stop USB playback. Press ▶/ again to resume playback.
Folder Access	Press ◀ to select the previous folder. Press ▶ to select the next folder. Note: Folder access is only available on USB/SD Card devices with more than one folder.
Repeat	Press RPT to enter the Repeat menu, then turn the volume knob to select one of the following options: <ul style="list-style-type: none">• All Songs - Plays all tracks on the USB/SD Card device.• Current Song - Continuously repeats selected track.• Current Folder - Continuously repeats all files in selected folder.
Random	Press RDM to enter the Random menu, then turn the volume knob to select one of the following options: <ul style="list-style-type: none">• Off - Cancels the RDM function.• All Songs - Plays all tracks in random order.• Current Folder - Plays all tracks in folder in random order. Note: Random mode is retained in memory when selecting between other modes and when the unit is turned on/off.
Intro	Press INT to enter the Intro menu, then turn the volume knob to select one of the following options: <ul style="list-style-type: none">• Off - Cancels the INT function.• All Songs - Plays first 10 seconds of each track.• Current Folder - Plays first 10 seconds of each track in folder.

USB / SD Card Operation

File and Folder Search

USB and SD card modes features a file and folder search mode. This search allows navigating through folders to find a specific file for playback.

Begin Searching	Press SELECT to enter the file/folder search mode. A list of all the folders from the USB device will be displayed. Note: Any files located in the root directory will be located in the folder named "ROOT".
Choose a song	Turn the volume knob to cycle through all the folders on the device and press SELECT to choose the desired folder. The list of files in the selected folder will be displayed. Turn the volume knob to cycle through the list of files.
Menu Navigation	Pressing ESC when viewing the contents of a folder will return to the list of folders on the USB device. Press ESC again to exit the search menu.
Playing a song	Once the desired song is displayed, press SELECT to begin playback of the desired song.

Search menu navigation

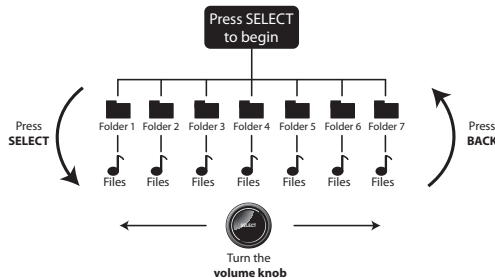

Controls for File/Folder search:

- **Volume knob:** Turn to cycle through the list of folders, or list of files in the current folder.
- **SELECT:** View the contents of the highlighted folder, or to play the highlighted file.
- **ESC:** Return to the previous folder, or to exit out of the menu while the root folder is being viewed.

USB / SD Card Operation

Displayed Information

Press **DISP** to select between displayed information such as ID3 tag information and file/folder names.

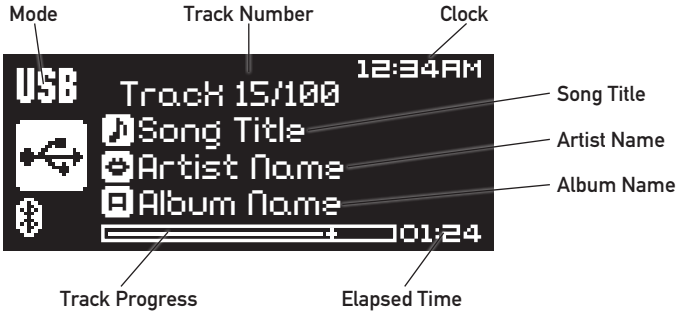

File/Folder Compatibility and Support

Compatible File Types	<ul style="list-style-type: none"> • MP3 data (.mp3) • WMA data (.wma)
Incompatible File Types	<ul style="list-style-type: none"> • DRM protected files • WMA lossless • Apple lossless • WMA Pro • MP3 Pro • MP3 playlists • M4A/AAC data • WAV lossless
Sampling Frequency Rate Compatibility	<ul style="list-style-type: none"> • MP3: 8kHz - 48kHz • WMA: 32kHz - 48kHz
Transfer Bit Rate Compatibility	<ul style="list-style-type: none"> • MP3: 32kbps - 320kbps • WMA: 32kbps - 192kbps
Character Support	<ul style="list-style-type: none"> • Song Title: 32 characters • Artist Name: 32 characters • Album Name: 32 characters • File Name: 32 characters • Folder Name: 32 characters
ID3 Tag Support	<ul style="list-style-type: none"> • MP3 Tags: Version 1.0 - 2.4 • WMA Tags
File/Folder Limit	<ul style="list-style-type: none"> • Maximum number of files: 50000 • Maximum number of folders: 255 (plus the root folder) • Maximum number of files in each folder: 50000 <p>Note: For devices with more than the maximum number of files/folders, some files will be ignored and may not function properly.</p>
USB/SD File System	<ul style="list-style-type: none"> • FAT/FAT32 file system supported. • HFS/NTFS/EXT2/EXT3 not supported.
SD Card Capacity	16GB or less supported.

Connecting an iPod/iPhone Device

Connecting an iPod or iPhone Device (sold separately)



To play music from an iPod/iPhone device using the direct USB interface, connect the USB cable (included with your iPod/iPhone device) to the XDMA6540's USB port. Once connected, playback will begin automatically.

Note: If a song is playing on the iPod or iPhone device before it is connected, it will continue to play after being connected.

Controlling a Device: Full Control

When the control of iPod/iPhone feature is set to "FULL" in the setup menu, use the following functions to control the device:

Song Select	Press ▶▶ to skip to the beginning of the next song. Press ◀◀ to return to the beginning of the current song. Pressing ◀◀ again skips to the beginning of the previous song.
Fast Forward and Reverse	Press and hold ▶▶ or ◀◀ to fast forward or reverse a song.
Pause	Press ▶/ to temporarily stop playback. Press ▶/ again to resume playback.
Repeat	Press RPT to enter the Repeat menu, then turn the volume knob to select one of the following options: <ul style="list-style-type: none"> • Off - Repeats all tracks. • Current Song - Repeats selected track.
Random	Press RDM to enter the Random menu, then turn the volume knob to select one of the following options: <ul style="list-style-type: none"> • Off - Cancels the RDM function. • All Songs - Plays all tracks in random order. • Current Album - Plays all tracks in the selected album in random order.
Intro	Press INT to enter the Intro menu, then turn the volume knob to select one of the following options: <ul style="list-style-type: none"> • Off - Cancels the INT function. • On - Plays first 10 seconds of each track.



Operation of iPod/iPhone

Controlling a Device: Full Control - Music Search

The XDMA6540 features a powerful music search that simplifies the searching process. Follow the steps below to find the desired song:

- Begin Searching** | Press **SELECT** to begin the search. The main search menu will appear.
- Select a Category** | Turn the **volume knob** to select between **artist, album, songs, playlist, podcast and audiobook**. Press **SELECT** to select the desired search category. Some categories have subcategories to navigate through. See the table below for details.

Search Category	Menu Navigation
Artist	Menu → Artists → Albums → Songs
Album	Menu → Albums → Songs
Songs	Menu → Songs
Playlist	Menu → Playlists → Songs
Audiobook	Menu → Audiobooks
Podcast	Menu → Podcasts

- Step Backwards** | Press **ESC** to return to the previous menu, or exit the search menu when the main menu is shown.
- Playing a Song** | Navigate to the desired song/podcast/audiobook and press **SELECT** to begin playback.

Note: If a specific category is selected, the iPod/iPhone device playback will be limited to that category until another category is selected in the search menu.

Device Compatibility

- Made for**
- iPod touch (4th generation)
 - iPod nano (6th generation)
 - iPod touch (3rd generation)
 - iPod nano (5th generation)
 - iPod touch (2nd generation)
 - iPod nano (4th generation)
 - iPod classic
 - iPod touch (1st generation)
 - iPod nano (3rd generation)
 - iPod nano (2nd generation)
 - *iPod nano (1st generation)
 - *iPod with video
 - iPhone 4
 - iPhone 3GS
 - iPhone 3G
 - iPhone

*These devices are not compatible with manual control mode.

Note: See page 17 for iPod and iPhone device compatibility with iTunes Tagging.

Operation of iPod/iPhone

Controlling a Device: Manual Control

When the control of iPod/iPhone feature is set to "MANUAL" in the iPod Menu, use the following functions to control the device:

Manual Control for iPod	When "MANUAL" control is selected from the iPod Menu, the iPod or iPhone device can be controlled directly from the device's interface. All functions except for volume can be used from the iPod or iPhone device.
Basic Head Unit Control	In addition to manual control of the iPod/iPhone device, the following basic functions are still active:
Song Select	Press ►► to skip to the beginning of the next song. Press ◀◀ to return to the beginning of the current song. Pressing ◀◀ again skips to the beginning of the previous song.
Pause	Press ►/ to temporarily stop playback. Press ►/ again to resume playback.
Volume	When playing an iPod device, the volume is adjustable using the volume knob on the front.
Compatibility	The firmware of the iPod must be updated to the latest version to be compatible with manual control mode.

Displaying Information

Press the DISP button to change between different types of information such as ID3 song information and the clock. Below is the default display for iPod mode.

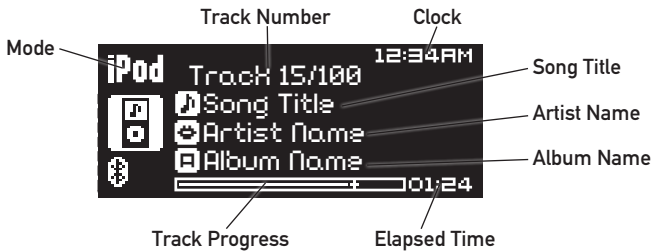

Character Support

Only alphanumeric characters can be displayed (ASCII type).

- "NO SUPPORT" will be displayed if the file contains characters that can not be displayed.
- "NO FILE" will be displayed if there are no songs in the selected playlist.

Maximum character display information

- *Song title – 32 character maximum
- *Artist name – 32 character maximum
- *Album name – 32 character maximum

*Song Title, Artist Name and Album name will only be displayed if included with the file.



Bluetooth® Operation

Pairing a Device

Preparation

Before you can use a Bluetooth device, it must be paired and connected. Make sure that Bluetooth is activated on your device before you begin the pairing process.

Pairing a New Device

The XDMA6540 broadcasts the pairing signal constantly when no devices are currently connected. Complete the pairing sequence from your Bluetooth device. Refer to the owner's manual for your device for more details.

**The device name is "DUAL BT"
The Bluetooth passcode "1234"**



Note: The XDMA6540 can be in any mode of operation when pairing is performed.

Pairing Additional Devices

If a device is currently connected, press and hold  to disconnect the current device before a new device can be paired. Then begin the pairing sequence from the new Bluetooth device.

(Re)Connecting a Paired Device

Most Bluetooth devices support the auto-connect feature, and will connect automatically if the device is in range when the XDMA6540 is powered-on. If your device was previously paired but does not connect, use these instructions below. Some devices require authorization to allow the auto connect feature.

- If your most recently connected Bluetooth device becomes disconnected or does not reconnect, press  from Bluetooth mode to reconnect your mobile device.
- To connect a previously paired device that was not recently connected:
 - 1) If applicable, press and hold  to disconnect any connected mobile devices.
 - 2) From Bluetooth mode, press **SELECT**. "Paired Devices" will appear on the LCD.
 - 3) Turn the volume knob to cycle through the list of devices.
 - 4) Press **SELECT** or  to connect to the desired device. It must be in range to connect.

Note: If the **Auto Connect** setup menu setting is set to **OFF**, you must press  to connect you device after pairing, and each time the XDMA6540 is powered-on.

Disconnecting a Device

Press and hold  for 3 seconds to disconnect a connected device. The device will remain paired and appear in the PAIRED DEVICES menu, but not be connected.



Bluetooth® Operation

Making a Phone Call

Manual Dialing

- Press once. "Enter Phone Number" will be shown, then an "_" will appear on the display.
- Using the remote control, enter the phone number using the 0-9 buttons. Press on the remote control or XDMA6540 front panel to begin dialing.

Note: Placing a phone call from your cell phone will also use the Bluetooth function of the XDMA6540.

Recent Calls List

- Press twice from Bluetooth mode to view the 10 most recent phone calls that were dialed, received or missed while connected to the XDMA6540.
- Turn the volume knob to cycle through the recent phone numbers. Press **SELECT** or to dial the phone number.

Redialing the last number

To redial the last phone number, press three times from Bluetooth mode. Dialing will begin automatically.

Receiving and Ending Phone Calls

Receiving a Phone Call

Incoming phone calls will automatically appear on the display and a ring tone will be heard.

Note: The volume of the ring tone depends on the volume level of the XDMA6540. The incoming ring tone may not be heard if the volume is set to a low level or mute is activated.

- Press to receive the incoming phone call.
- Press to refuse the incoming phone call.

Note: If **Auto Answer** is set to **ON** in the setup menu, all phone calls will be received automatically.





Ending a Phone Call

During an active phone call, press to end a phone call. If the phone call was received when listening to music in another mode, the XDMA6540 will resume the previous mode.



Bluetooth® Operation

During a Phone Call

Volume	Turn the volume knob to adjust the volume level during a phone call. Bluetooth mode has a separate volume level from the main volume of other modes. The XDMA6540 will remember the volume level in Bluetooth mode and always return to the last volume level for each phone call.
Microphone Mute	Press MUTE during a phone call to turn the XDMA6540's external microphone off. Press MUTE again to resume microphone operation.
Audio Transfer	Press DISP during a phone call to transfer the call from the XDMA6540 to the cell phone. Press DISP again to toggle the audio back to the XDMA6540.
Call Waiting	During a phone call, if there is a second incoming call, press  to place the first call on hold and switch to the second phone call. Press  again to switch back to the first call.
Call Hold	During a phone call, when there are no additional incoming calls, press  to place the call on hold. Press  again to resume the phone call.

Note: Audio transfer, call waiting and call hold must be supported by the mobile phone and service provider to function properly.

Bluetooth® Operation

Streaming Audio Operation

The XDMA6540 supports A2DP (advanced audio distribution profile) wireless streaming audio from your Bluetooth mobile device directly to your head unit. You can also control your music from the front panel of the head unit using AVRCP (audio video remote control profile).

Notes:

- To stream music to your head unit, your mobile device must support the A2DP and AVRCP Bluetooth profiles. Check the owner's manual of your mobile device for details.
- Streaming audio must be enabled from your mobile device. This option will vary depending on the device. Some devices allow streaming audio to be disabled.

After pairing, connecting and enabling streaming audio from a compatible mobile device, begin playing music using the music player on your mobile device. Once the music is playing, the following functions can be used to control the music:

- The ►► button will skip to the next available audio track.
- The ◀◀ button will skip to the previous audio track.
- The ►/|| button will toggle between play and pause during playback.
- The ⏻ button will stop the audio playback.

Note: Some Bluetooth devices may not fully support these commands.

Bluetooth Reset

Resetting the Bluetooth module will remove the list of paired phones and delete the list of recent calls from memory.

To reset Bluetooth, perform the following steps:

- 1) Press **MODE UP/DOWN** until the head unit is in Bluetooth mode.
- 2) Press and hold **MENU** for 3 seconds to reset the Bluetooth settings back to the factory default.

Compatibility Note:

Due to the differences in Bluetooth technology, some mobile devices may be incompatible, function improperly or may not support all features when used with the XDMA6540.



Troubleshooting - General

Problem	Cause	Action
Unit will not turn on (no power)	Yellow wire not connected or incorrect voltage Red wire not connected or incorrect voltage	Check connections for proper voltage (11-16VDC)
	Black wire not connected	Check connection to ground
	Fuse blown	Replace fuse
Unit has power (but no sound)	Speaker wires not connected	Check connections at speakers
	One or more speaker wires touching each other or touching chassis ground	Insulate all bare speaker wires from each other and chassis ground
Unit blows fuses	Yellow or red wire touching chassis ground	Check for pinched wire
	Speaker wires touching chassis ground	Check for pinched wire
	Incorrect fuse rating	Use fuse with correct rating
Excessive Skipping	Unit is not mounted correctly or backstrap is not secure	Check mounting sleeve and backstrap support
	Physical defect in CD, CD-R/RW disc	Check media for scratches
ERROR-02 appears on display	Disc read error or disc is in upside down	Press EJECT or RESET
CD will not eject	CD mechanism error	Hold EJECT for 3 seconds to force eject the CD
PROTECT appears on display	The WMA file is copy-protected by DRM (Digital Rights Management)	Write disc using WMA files that are not copy-protected
NO FILE appears on display	Selected file is not available in direct or alphanumeric search modes	Repeat search using valid parameters
NO SUPPORT appears on display	An invalid ID3 tag version is present, or a non-ASCII character is included	Version 1.0 to 2.4 ID3 tags and only ASCII characters are supported.
Parental Control Lock Code Reset	If the parental control lock code has been forgotten or lost, press RESET located behind the front panel to reset the code to "0000".	



Limited One Year Warranty

This warranty gives you specific legal rights. You may also have other rights which vary from state to state.

Dual Electronics Corp. warrants this product to the original purchaser to be free from defects in material and workmanship for a period of one year from the date of the original purchase.

Dual Electronics Corp. agrees, at our option, during the warranty period, to repair any defect in material or workmanship or to furnish an equal new, renewed or comparable product (whichever is deemed necessary) in exchange without charges, subject to verification of the defect or malfunction and proof of the date of purchase. Subsequent replacement products are warranted for the balance of the original warranty period.

Who is covered? This warranty is extended to the original retail purchaser for products purchased from an authorized Dual dealer and used in the U.S.A.

What is covered? This warranty covers all defects in material and workmanship in this product. The following are not covered: software, installation/removal costs, damage resulting from accident, misuse, abuse, neglect, product modification, improper installation, incorrect line voltage, unauthorized repair or failure to follow instructions supplied with the product, or damage occurring during return shipment of the product. Specific license conditions and copyright notices for the software can be found via www.dualav.com.

What to do?

1. Before you call for service, check the troubleshooting guide in your owner's manual. A slight adjustment of any custom controls may save you a service call.
2. If you require service during the warranty period, you must carefully pack the product (preferably in the original package) and ship it by prepaid transportation with a copy of the original receipt from the retailer to an authorized service center.
3. Please describe your problem in writing and include your name, a return UPS shipping address (P.O. Box not acceptable), and a daytime phone number with your shipment.
4. For more information and for the location of the nearest authorized service center please contact us by one of the following methods:

- Call us toll-free at 1-866-382-5476
- E-mail us at cs@dualav.com

Exclusion of Certain Damages: This warranty is exclusive and in lieu of any and all other warranties, expressed or implied, including without limitation the implied warranties of merchantability and fitness for a particular purpose and any obligation, liability, right, claim or remedy in contract or tort, whether or not arising from the company's negligence, actual or imputed. No person or representative is authorized to assume for the company any other liability in connection with the sale of this product. In no event shall the company be liable for indirect, incidental or consequential damages.



Specifications

FM Tuner	Tuning range: 87.5MHz-107.9MHz Usable sensitivity: 8.5dBf 50dB quieting sensitivity: 10dBf Stereo separation @ 1kHz: 40dB Frequency response: 30Hz-13kHz
AM Tuner	Tuning range: 530kHz-1710kHz Usable sensitivity: 22uV Frequency response: 30Hz-2.2kHz
General	Speaker output impedance: 4~8 ohms Line output voltage: 2 Volts RMS Dimensions: 7" x 7" x 2" (178 x 178 x 51 mm)
USB/SD Card	File system: FAT, FAT32 File extension support: .mp3, .wma SD Card maximum device capacity: 16GB
Bluetooth® Profiles	HFP (hands-free profile) A2DP (advanced audio distribution profile) AVRCP (audio video remote control profile)

Design and specifications subject to change without notice.



CEA-2006 Power Standard Specifications (reference: 14.4VDC +/- 0.2V, 20Hz~20kHz)

Power Output: 18 Watts RMS x 4 channels at 4 ohms and $\leq 1\%$ THD+N
Signal to Noise Ratio: 80dBA (reference: 1 watt into 4 ohms)



FCC Compliance

This device complies with Part 15 of the FCC Rules. Operation is subject to the following two conditions:

- (1) this device may not cause harmful interference, and
- (2) this device must accept any interference received, including interference that may cause undesired operation.

Warning: Changes or modifications to this unit not expressly approved by the party responsible for compliance could void the user's authority to operate the equipment.

Note: This equipment has been tested and found to comply with the limits for a Class B digital device, pursuant to Part 15 of the FCC Rules. These limits are designed to provide reasonable protection against harmful interference in a residential installation. This equipment generates, uses and can radiate radio frequency energy and, if not installed and used in accordance with the instructions, may cause harmful interference to radio communications. However, there is no guarantee that interference will not occur in a particular installation. If this equipment does cause harmful interference to radio or television reception, which can be determined by turning the equipment off and on, the user is encouraged to try to correct the interference by one or more of the following measures:

- Reorient or relocate the receiving antenna.
- Increase the separation between the equipment and receiver.
- Connect the equipment into an outlet on a circuit different from that to which the receiver is connected.
- Consult the dealer or an experienced radio/TV technician for help.



Dual Electronics Corp.
Toll Free: 1-866-382-5476

www.dualav.com

©2011 Dual Electronics Corp. All rights reserved.

iPhone, iPod, iPod classic, iPod nano, and iPod touch are trademarks of Apple Inc., registered in the U.S. and other countries.

"Made for iPod" and "Made for iPhone" mean that an electronic accessory has been designed to connect specifically to iPod or iPhone, respectively, and has been certified by the developer to meet Apple performance standards. Apple is not responsible for the operation of this device or its compliance with safety and regulatory standards. Please note that the use of this accessory with iPod or iPhone may affect wireless performance.

The Bluetooth® word mark and logos are owned by the Bluetooth SIG, Inc. and any use of such marks by Namsung is under license.

Sirius, XM and associated marks are registered trademarks of Sirius XM Inc. all rights reserved.

HD Radio™, HD Radio Ready™, and the HD Radio Ready logo are proprietary trademarks of iBiquity Digital Corporation.

The SD logo is a trademark of the SD Card Association.

Other trademarks and trade names are those of their respective owners.

NSA0811-V01

Download from Www.Somanuals.com. All Manuals Search And Download.

Free Manuals Download Website

<http://myh66.com>

<http://usermanuals.us>

<http://www.somanuals.com>

<http://www.4manuals.cc>

<http://www.manual-lib.com>

<http://www.404manual.com>

<http://www.luxmanual.com>

<http://aubethermostatmanual.com>

Golf course search by state

<http://golfingnear.com>

Email search by domain

<http://emailbydomain.com>

Auto manuals search

<http://auto.somanuals.com>

TV manuals search

<http://tv.somanuals.com>