

DVD/CD/MP3 PLAYER

DVD-427 USER'S MANUAL

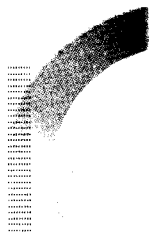

Please read this manual before connection and use.



English

IMPORTANT SAFETY INSTRUCTIONS

1. Read these instructions.
2. Keep these instructions.
3. Heed all warnings.
4. Follow all instructions.
5. Do not use this apparatus near water.
6. Clean only with a damp cloth.
7. Do not block any of the ventilation openings. Install in accordance with the manufacturers Instructions.
8. Do not install near any heat sources such as radiators, heat registers, stoves, or other apparatus (including amplifiers) that generate heat.
9. Do not defeat the safety purpose of the polarized or grounding- type plug. A polarized plug has two blades with one wider than the other. A grounding type plug has two blades and a third grounding prong. The wide blade or the third prong are provided for your safety. When the provided plug does not fit into your outlet, consult an electrician for replacement of the obsolete outlet.
10. Protect power cord from being walked on or pinched particularly at plugs, convenience receptacles, and the point where they exit from the apparatus.
11. Only use attachments/accessories specified by the manufacturer.
12. Use only with a cart, stand, tripod, bracket, or table specified by the manufacturer, or sold with the apparatus. When a cart is used, use caution when moving the cart/apparatus combination to avoid injury from tip-over.



Portable Cart Warning

13. Unplug this apparatus during lightning storms or when unused for long periods of time.
14. Refer all servicing to qualified service personnel. Servicing is required when the apparatus has been damaged in any way, such as power-supply cord or plug is damaged, liquid has been spilled or objects have fallen into the apparatus, the apparatus has been exposed to rain or moisture, does not operate normally, or has been dropped.

SAFETY INFORMATION

TO REDUCE THE RISK OF FIRE AND ELECTRIC SHOCK, DO NOT EXPOSE THIS UNIT TO RAIN OR MOISTURE.



CAUTION: To reduce the risk of fire and electric shock, do not remove the cover (or back) of the unit. Refer servicing only to qualified service personnel.



The lightning flash with arrowhead symbol, within an equilateral triangle, is intended to alert the user to the presence of uninsulated "dangerous voltage" within the product's enclosure that may be of sufficient magnitude to constitute a risk of electric shock.



The exclamation point within an equilateral triangle is intended to alert the user to the presence of important operation and servicing instructions in the literature accompanying the appliance.

WARNING: TO REDUCE THE RISK OF FIRE OR ELECTRIC SHOCK, DO NOT EXPOSE THIS APPLIANCE TO RAIN OR MOISTURE.

CAUTION: TO PREVENT ELECTRIC SHOCK, MATCH WIDE BLADE OF PLUG TO WIDE SLOT, FULLY INSERT.

IMPORTANT SAFE GUARDS

In addition to the careful attention devoted to quality standards in the manufacture of your video product, safety is a major factor in the design of every instrument. However, safety is your responsibility, too. This sheet lists important information that will help to assure your enjoyment and proper use of the video product and accessory equipment. Please read them carefully before operation and using your video product.

Installation

1. Read and Follow Instructions-All the safety and operation instructions should be read before the video product is operated. Follow all operating instructions.
 2. Retain Instructions-The safety and operating instructions should be retained for future reference.
 3. Heed all Warnings-Comply with all warnings on the video product and in the operating instructions.
 4. Polarization-This video product is equipped with a polarized alternating-current line plug. This plug will fit into the power outlet, try reversing the plug. If the plug still fails to fit, contact your electrician to replace your obsolete outlet. To prevent electric shock, do not use this polarized plug with an extension cord, receptacle, or other outlet unless the blades can be fully inserted without blade exposure. If you need an extension cord, use a polarized cord.
 5. Power Sources- This video product should be operated only from the type of power source indicated on the marking label. If you are not sure of the type of power supply to your home, consult your video dealer or local power company. For video products intended to operate from battery power, or other sources, refer to the operating instructions.
 6. Overloading- Do not overload wall outlets or extension cords as this can result in a risk of fire or electric shock. Overloaded AC outlets, extension cords, frayed power cords, damaged or cracked wire insulation, and broken plugs are dangerous. They may result in a shock or fire hazard. Periodically examine the cord, and if its appearance indicates damage or deteriorated insulation, have it replaced by your service technician.
 7. Power- Cord Protection- Power-supply cords should be routed so that they are not likely to be walked on or pinched by items placed upon or against them, paying particular attention to cords at plugs, convenience receptacles, and the point where they exit from the video product.
 8. Ventilation- Slots and openings in the case are provided for ventilation to ensure reliable operation of the video product and to protect it from overheating. These openings must not be blocked or covered. The openings should never be blocked by placing the video product on a bed, sofa, rug, or heat register. This video product should not be placed in a built-in installation such as a book case or rack, unless proper ventilation is provided or the video product manufacturer's instructions have been followed.
 9. Attachments- Do not use attachments unless recommended by the video product manufacturer as they may cause hazards.
 10. Water and Moisture- do not use this video product near water for example, near a bath tub, wash bowl, kitchen sink or laundry tub, in a wet basement, or near a swimming pool and the like. Caution: Maintain electrical safety. Powerline operated equipment or accessories connected to this unit should bear safety certification mark on the accessory itself and should not be modified so as to defeat the safety features. This will help avoid any danger and should not be modified so as to defeat the safety features. This will help avoid any potential hazard from electrical shock or fire. If in doubt, contact qualified service personnel.
 11. Accessories- Do not place this video product on an unstable cart, stand, tripod, bracket, or table. The video product may fall, causing serious injury to a child or adult as well as serious damage to the video product. Use this video product only with a cart, stand, tripod, bracket, or table recommended by the manufacturer's or sold with the video product. Any mounting of the product should follow the manufacturer's instructions and use of a mounting accessory recommended by the manufacturer.
 12. A video product and cart combination should be moved with care. Quick stops, excessive force, and uneven surfaces may cause the video product and cart combination to overturn.
Note to CATV system installer
This reminder is provided to call the CATV system installer's attention to Section 820-40 of the NEC which provides guidelines for proper grounding and in particular, specifies that the cable ground shall be connected to the grounding system of the building, as close to the point of cable entry as practical.
 13. Outdoor Antenna Grounding: If an outside antenna or cable system is connected to the video product, be sure the antenna or cable system is grounded so as to provide some protection against voltage surges and built-up static charges. Section 810 of the National Electrical Code, ANSI/NFPA No. 70-1984 (Section 54 of Canadian Electrical Code Part 1) provides information with respect to proper grounding of the mast and supporting structure, grounding of the lead-in wire to an antenna-discharge unit, connection to grounding electrodes, and requirements for the grounding electrode.
 14. Power Lines- An outside antenna system should not be located in the vicinity of overhead power lines, other electric light or power circuits, or where it can fall in to such power lines or circuits. When installing an outside antenna system, extreme care should be taken to keep from touching or approaching such power lines or circuits, as contact with them might be fatal. Installing an outdoor antenna can be hazardous and should be left to a professional antenna installer.
- ### Use
15. Cleaning- Unplug this video product from the wall outlet before cleaning. Do not use liquid cleaners or aerosol cleaners. Use a soft dry cloth for cleaning.
 16. Objects that may touch dangerous voltage points or "short-out" parts could result in a fire or electric shock. Never spill liquid of any kind on the video product.
 17. Lightning- For added protection for this video product during a lightning storm, or when it is left unattended and unused for long periods of time, unplug it from the wall outlet and disconnect the antenna or cable system. This will prevent damage to the video product due to lightning and power line surges.
- ### Service
18. Servicing- Do not attempt to service this video product yourself, as opening or removing covers may expose you to dangerous voltage or other hazards. Refer all servicing to qualified service personnel.
 19. Conditions requiring service- unplug this video product from the wall outlet, refer servicing to qualified service personnel under the following conditions:
 - A. When the power- supply cord or plug is damaged.
 - B. If liquid has been spilled, or objects have fallen in to the video product.
 - C. If the video product has been exposed to rain or water.
 - D. If the video does not operate normally by following the instruction manual. Adjust only those controls that are covered by operating instructions. Improper adjustment of other controls may result in damage and will often require extensive work by a qualified technician to restore the video product to its normal operation.
 - E. If the video product has been dropped or cabinet has been damaged.
 - F. When the video product exhibits a distinct change in performance-this indicates a need for service.
 20. Replacement Parts- When replacement parts are required, have the service technician verify that the replacements he uses have the same safety characteristics as the original parts. Use of replacements specified by the video product manufacturer can prevent fire, electric shock or other hazards.
 21. Safety Check- Upon completion of any service or repairs to this video product, ask the service technician to perform safety checks recommended by the manufacturer to determine that the video product is in safe operating condition.
 22. Wall or Ceiling Mounting- The product should be mounted to a wall or ceiling only as recommended by the manufacturer.
 23. Heat- The product should be situated away from heat sources such as radiators, heat registers, stoves, or other products (including amplifiers) that products heat.

FEATURES

DVD, CD, MP3 compatible
CD-R, CD-RW capable

TV format:

PAL / NTSC color system
4:3 / 16:9 screen format select

Video output:

Composite Video output
S-Video output
Component Video (Y Pb/Cb Pr/Cr) output

Audio output:

Down-mix stereo output
Digital audio output (coaxial)
Dolby Digital output
DTS Digital output

DVD features:

Multi Subtitle select
Multi Language select
Multi Angle select

Other features:

On screen display menu
Digital zooming
Slow motion
Parental control
JPEG picture view

Manufactured under license from Dolby Laboratories.
Dolby and the double-D symbol are trademarks of
Dolby Laboratories. Confidential Unpublished Works.
© 1992-1997 Dolby Laboratories.
All rights reserved.

This product incorporates copyright protection technology that is
protected by method claims of certain U.S. patents and other
intellectual property rights owned by Macrovision Corporation and
other rights owners. Use of this copyright protection technology
must be authorized by Macrovision Corporation, and is intended for
home and other limited viewing uses only unless otherwise
authorized by Macrovision Corporation. Reverse engineering or
disassembly is prohibited.



The player has built in copyright
protection technology that
prevents copying from a DVD
disc to any media.

**If a video recorder is connected to
the player, the video output image
will be distorted during recording.**

CONTENTS

IMPORTANT SAFETY INSTRUCTIONS Page

SAFETY INFORMATION

FEATURES

CONTENTS

INTRODUCTION

About DVD 1-4
About MP3 1-2
About the player 2
Front panel 3
Rear panel 3
Remote control 4

SYSTEM CONNECTION

System connection figure 5-7
Connecting to a TV set 5
Connecting to stereo amplifier 6
Connecting to digital amplifier 7

GETTING STARTED

Play a disc 8-9
Problem disc message 8
Power management 9

ON SCREEN DISPLAY

DVD mode 10-11
CD mode 10
MP3 mode 11

FUNCTION BUTTONS

12-15

SETUP MENU

LANGUAGE 16-17
AUDIO SETUP 16
SCREEN SETUP 17
CUSTOM SETUP 18

TROUBLE SHOOTING

19-20

SPECIFICATIONS



21

INTRODUCTION

About DVD



DVD (Digital Versatile Disc) is a digital video medium under the MPEG II format, featuring a variety of revolutionary entertainment capabilities. The MPEG II video compression technology provides capacity for an excellent picture of minimum 500 lines resolution on screen, up to 8 language soundtracks, up to 9 views from different camera angles and up to 32 language subtitles (provided by the DVD disc itself which supports these features).

Disc information

Disc types	DVD	CD
Decoding Method	Digital / MPEG II	Digital
Capacity	Single-layer / Single side 4.7GB=2hr Single-layer / Double sides 8.5GB=4hr Double-layers / Single side 9.4GB =4.5 hr Double-layers / Double sides 17GB = 8 hr	650MB = 74 min
Disc size	12cm / 8cm	12cm / 8cm
Horizontal Resolution	500 lines up	-
Sub-titles	32	-
Sound tracks	8	1
Symbol		

DVD features symbols

Each DVD disc contains various features depending on production of the disc. Below are some of the symbols representing the features:

-  Number of Audio Tracks
-  Screen Format
-  Number of Subtitles
-  Zoom
-  Angle Indicator

 The player has built in copyright protection technology that prevents copying from a DVD disc to any media.

If a video recorder is connected to the player, the video output image will be distorted during recording.

REMARK

Some features contained in this DVD player are related to the DVD disc's software.

Some features cannot be performed if the disc does not support the feature, or requires special settings.

Check the features printed on the disc's packing or follow the instructions of the Disc's on screen menu.

Select a DVD disc

DVD Region Code

DVD discs and DVD players are manufactured under the worldwide agreed DVD Regional Code System that the player will operate only with corresponding disc of the same Regional Code.

Region code	Region
1	Canada, USA
2	Europe (incl. Poland, Romania, The Czech republic), Japan, Middle East (incl. Saudi Arabia, Egypt, Iran, South Africa)
3	East Asia (incl. HongKong, Taiwan, South Korea), South-East Asia
4	Australia, Caribbean, Central & South America, Mexico, New Zealand
5	Africa, Former Soviet Union, India, North Korea, Pakistan, Turkmenistan
6	China

Care of disc

Video disc contains high-density compressed data that needs proper handling

- Hold the disc with fingers. Hold the disc's outer edge and/or the center spindle hole. Do not touch the disc surface.



- Do not bend or press the disc. Do not expose the disc to direct sunlight or heating sources.



- Store discs in cabinet vertically, in dry condition.

- Prevent exposure to:
- Direct sunlight
 - Heat or exhaust from a heating device.
 - Extreme humidity.

- Clean the disc surface with a soft, dry cleaning cloth. Wipe the disc surface gently, radially, from center toward the outer edge.

- Do not apply thinner, alcohol chemical solvent, or sprays when cleaning. Such cleaning fluids will permanently damage the disc surface.

This player is compatible to the following disc types:

DVD single sided / double sided
single layered / double layered

CD-DA
CD-MP3
CD-R / CD-RW*
PICTURE CD

***NOTE:** Some PC application files on CD-R or CD-RW **CANNOT** be accepted by the unit, e.g. CD-ROM under PC Windows, etc. (CD-R/CD-RW writing format may be different, some discs are not acceptable)

About MP3

MP3 (MPEG 1, Audio Layer3) is a digital audio format for quick down loading files that sound as good as CDs. MP3 uses entropy encoding to reduce the number of redundant sounds in an audio signal to a minimum. It takes music from a CD and reduces it by a factor of 12, with no noticeable loss of quality. On a normal CD of 74 minutes you can store over 130 songs.

Disc information

Sampling rate should be 44.1 kHz and bit rate is recommended within the range from 128 Kbps to 256 Kbps, in order to achieve the best performance. In general, higher quality settings result in larger file sizes.

MP3 Format

Sampling rate	Bit rate	Quality
44.1 kHz	56 Kbps	↓ FM Radio Quality
44.1 kHz	64 Kbps	
44.1 kHz	80 Kbps	↓ Near CD Quality
44.1 kHz	96 Kbps	
44.1 kHz	112 Kbps	
44.1 kHz	128 Kbps	↓ Good CD Quality
44.1 kHz	160 Kbps	
44.1 kHz	192 Kbps	↓ Better than CD Quality
44.1 kHz	224 Kbps	
44.1 kHz	256 Kbps	↓ Studio Quality

No-play disc

The following discs are **NOT** acceptable by the DVD player:

- DVD disc with Region code that does not match the player's Region code. The player will not recognize the format. (Check the disc's region code printed on the disc packing. Region code "ALL" will be acceptable by all players.)
- Some DVD discs that were purchased outside the application country
- PC application on CD-R/CD-RW
- CD-ROM for PC interface only
- CD-MP3 under Windows format
- MP3 CD-R/CD-RW of not proper format (see "Tips for making a good MP3 CD" below)

Tips for making a good MP3 CD

- Use good quality CD-RW disc, CD-R Gold Ultima is recommended. Up to 650 MB (74-minute CD) of MP3 files can be recorded.
- Select a high quality CD Recorder (Writer). HP CD-Write+9200 is recommended.
- Select an advance CD burning software. Easy CD Creator 4.0 or higher version is recommended.
- MP3 is data and not WAV information as such Mode1 must be selected when compiling and burning your discs.
- Drag and drop (Direct CD) must not be used to compile the disc. The player will not recognise this format.
- Only single session recordings can be used. Multi session recordings are not recognised and will not be played.
- Select Data CD Project (software user interface), file system should comply with the standard of ISO 9660 or Joliet. OR select MP3 CD Project for convenience operation (available in Easy CD Creator 5.0)
- It is advised to finalize the CD after burning.

About the player

Front panel

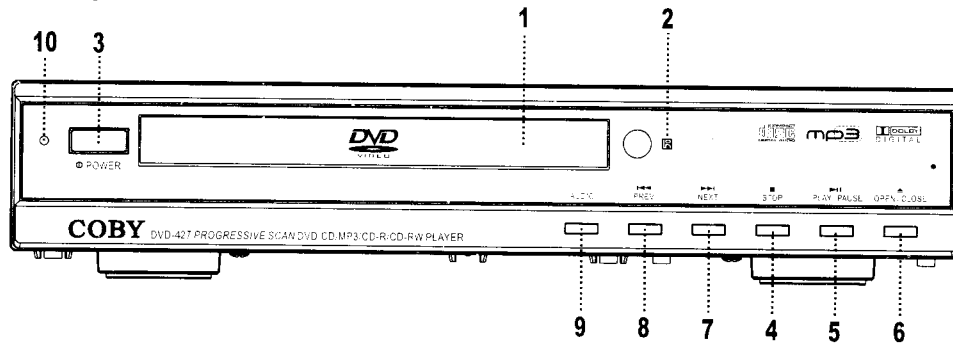

- | | |
|--------------------------|-----------------------------|
| 1. Disc tray | 6. Open/close button |
| 2. Remote control sensor | 7. Next button |
| 3. Power button | 8. Previous button |
| 4. Stop button | 9. Audio button |
| 5. Play/pause button | 10. Power standby indicator |

Rear panel

Y/Cb/Cr Component Video Output for Progressive Scan

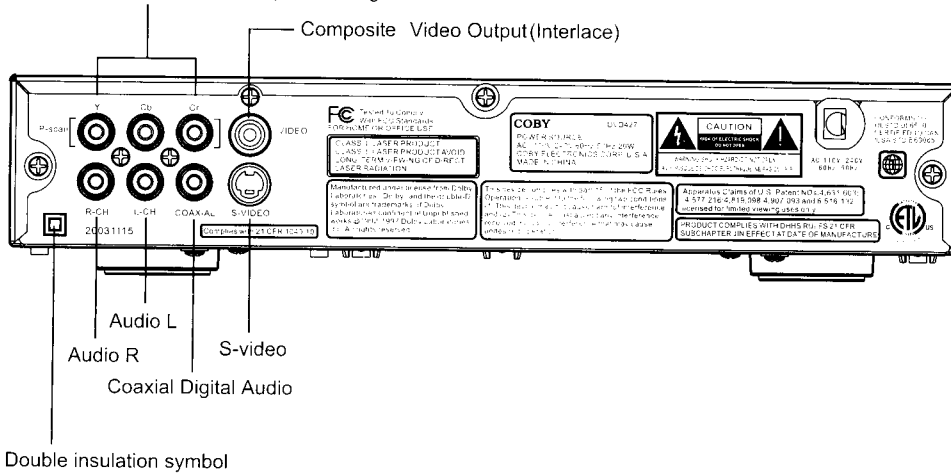

Double insulation symbol

Remote control surface

1. POWER button
2. PBC button
3. SUBTITLE button
4. NUMERIC buttons
5. CLEAR button
6. STEP button
7. SLOW button
8. CURSOR buttons
9. SETUP button
10. MUTE button
11. FAST FORWARD/
FAST BACKWARD button
12. MENU button
13. TITLE button
14. OPEN/CLOSE button
15. OSD button
16. TV.SYS button
17. ANGLE button
18. AUDIO button
19. PROGRAM button
20. VOLUME button
21. GOTO button
22. REPEAT A-B button
23. REPEAT button
24. ZOOM button
25. ENTER button
26. RETURN button
27. PAUSE button
28. PLAY button
29. STOP button
30. SKIP button
31. PSCAN button

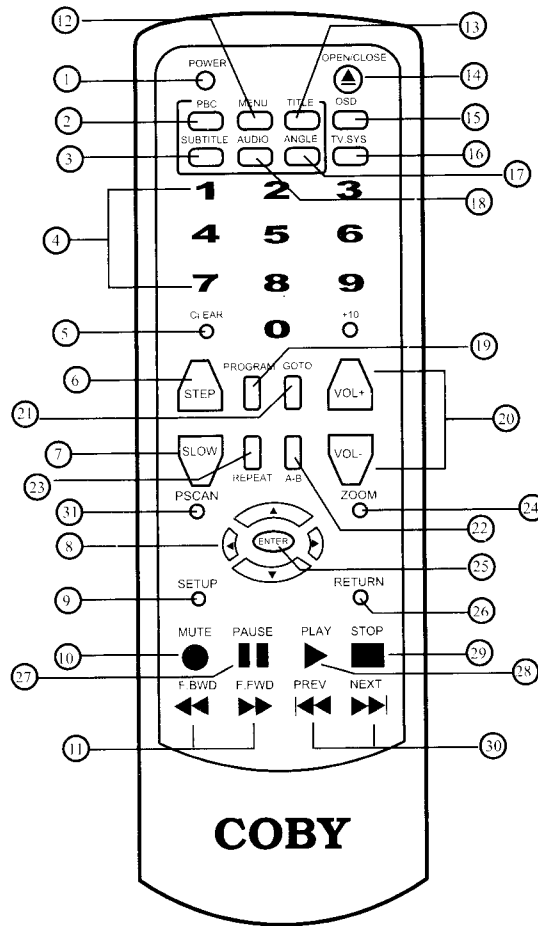

Notes

The remote control transmits a directional infrared beam. Be sure to aim the remote control directly at the infrared sensor during operation. When the sensor is covered or there is a large object between the remote control and the sensor, the sensor cannot receive signals. The sensor may not be able to receive signals properly when it is exposed to direct sunlight or a strong artificial light (such as fluorescent or strobe light). In this case, change the direction of the light or reposition the unit to avoid direct lighting.

SYSTEM CONNECTION
System connection figure

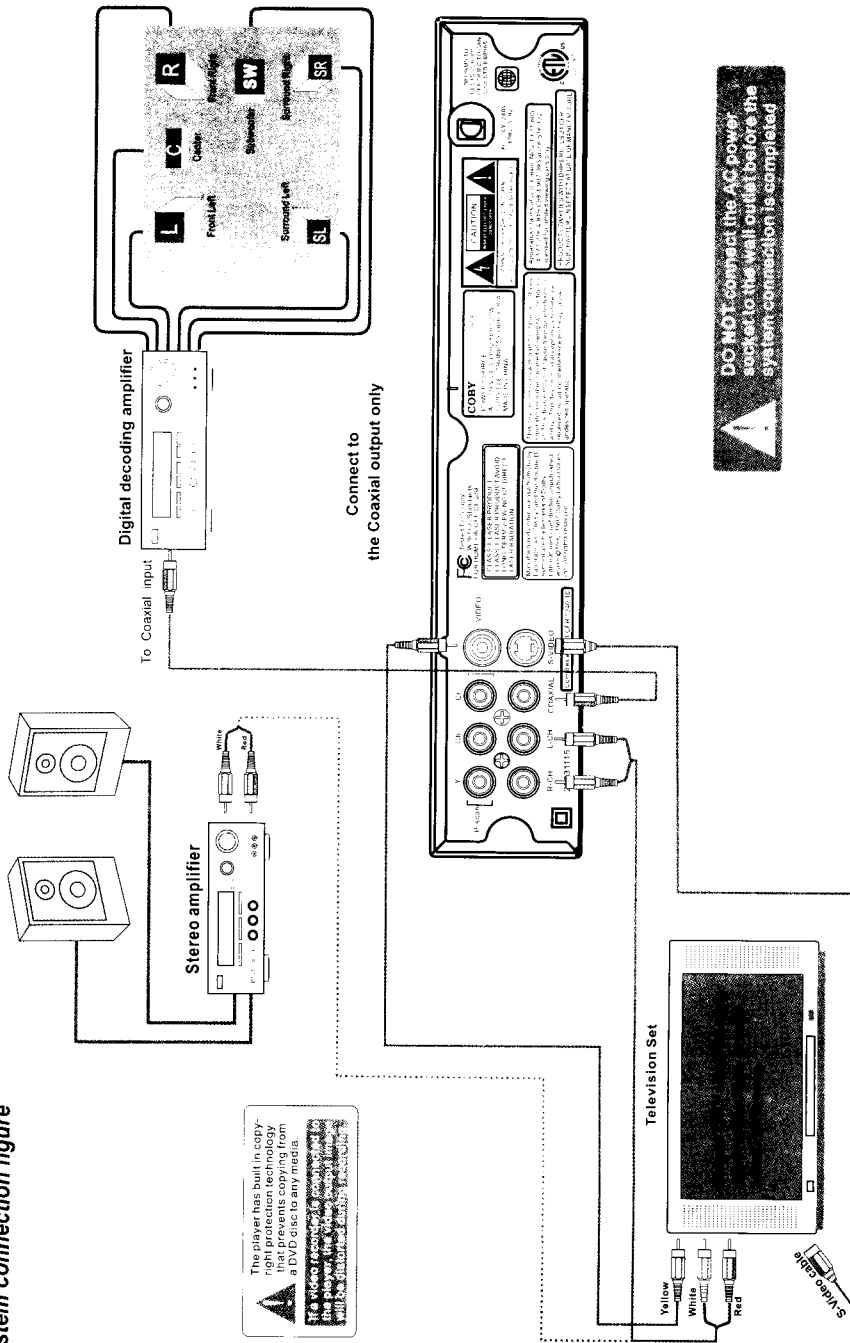

System connection to a TV set

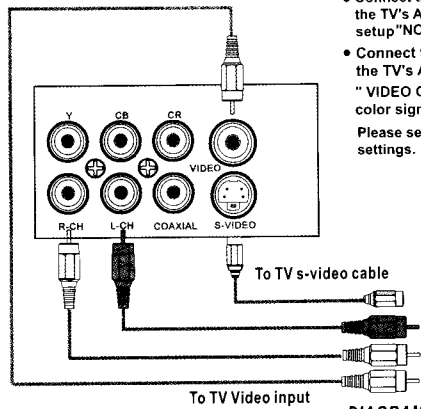

DIAGRAM1

- Select **ONE** of the below connections **ONLY**:
- Connect the player's L and R Audio and Video (or S-Video) Outputs to the TV's Audio L&R Audio and Video (or S-Video) Inputs. "VIDEO OUT" setup "NORMAL", see Diagram 1.
 - Connect the player's L and R Audio and Y, Cb, Cr Video Outputs to the TV's Audio L&R Audio and Y, Cb, Cr Video Inputs. "VIDEO OUT" setup "YUV", "Y" is brightness signal, "Cb" & "Cr" color signals, see Diagram 2.
- Please see the Set Up Menu on Page 17 for the correct Video Output settings.

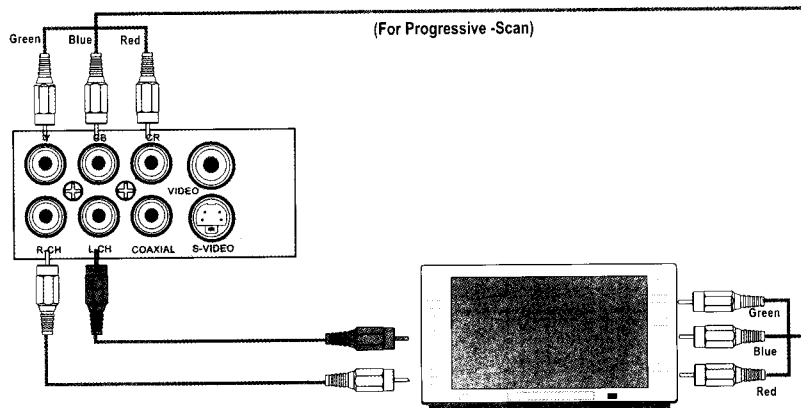

DIAGRAM2

NOTE Connect ONE of the above options ONLY, to avoid picture interference.

- 1 The player is equipped with composite A/V outputs at the rear of the player. Your TV will require at least one set of A/V inputs. The patch cord supplied with the player will connect your player's A/V output to your TV'S inputs.
- 2 Please remember to push the "Line" or "Input" or "Video/TV" button on your TV remote to view the DVD signal. Depending on your brand of TV, this button will have a different name for the same function, as per the examples above.
- 3 That function will allow your TV to be switched from the broadcast reception mode to one of the A/V signals. Some TVs have more than one A/V input.
- 3 The player is equipped for stereo playback. To fully realize 2-channel sound, a Stereo TV or A/V receiver is necessary. However, a Mono TV may be used providing the TV one set of A/V Inputs. The A/V input for Mono sound. You may connect either the Left or Right audio channel from the DVD Composite audio out to the mono TV audio input.

SYSTEM CONNECTION

Audio connecting to a stereo Amplifier

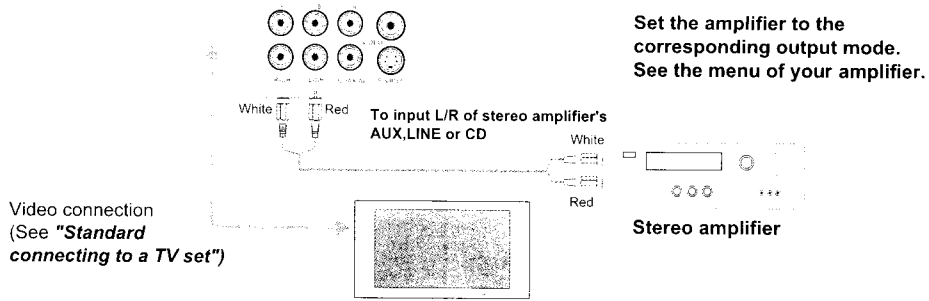

Digital audio connection to a digital Amplifier

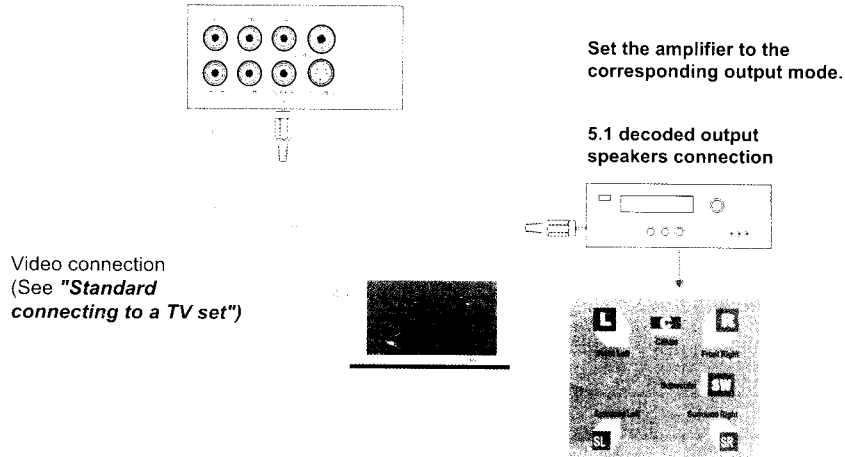

Digital output is selective in two formats: "RAW" or "PCM". See "SET UP MENU" of this manual for your amplifier for the appropriate setting of PCM or RAW.

Connecting to an active subwoofer and speakers

DVD427 supplies the accessories as following:
one Active Subwoofer and two speakers

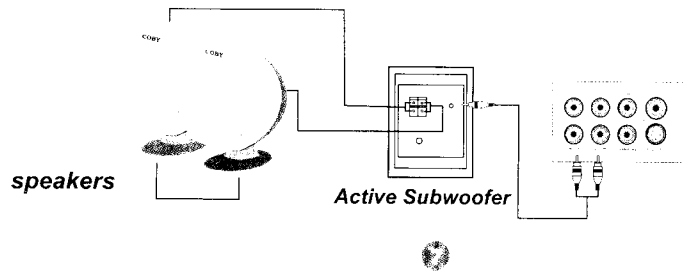

- Unpack the unit.
- Read through this owner's manual before installation and use.
- Loading batteries in the remote control.
- Connect the system, make sure the connections are secure.
- Connect the power plug to the AC power outlet.

Loading batteries in the remote control

- Remove the battery compartment cover.
- Load two AAA (UM-4 or R03) batteries into the battery compartment.
- Make sure that the batteries have been inserted in the correct polarities matching to the symbols+, - marked in the battery compartment. Close the battery compartment cover.
- When replacing batteries, replace both batteries. Do not mix new and used batteries operating together, otherwise, the operation lifetime will be much shorter than normal.
- Remove the batteries if the unit will not be used for a prolonged period of time.

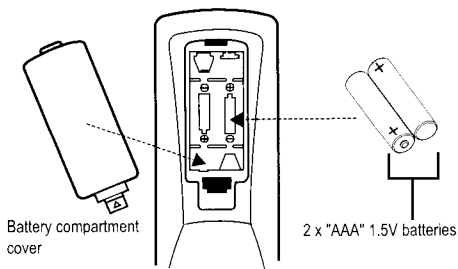

The remote control transmits a directional infrared beam. Be sure to aim the remote control directly at the infrared sensor of the unit during operation.

If the sensor has been covered or there is a large object between the remote control and the sensor, the sensor will not respond.

The sensor may not be able to receive the remote signal when it is exposed to direct sunlight or a strong artificial light (fluorescent or strobe light). In this case, change the direction of the light or reposition the unit to avoid direct lighting.

Switch on the player

Press the main power switch on the DVD player. Power on the TV set, and the amplifier is connected.

Set up the system

Select the corresponding setting of the TV set (AV1, AV2, S-Video, DVD etc.). For a RF modulator connection, select the appropriate channel to view the disc.

If amplifier has been connected, select the corresponding output mode.

Load a disc

Press OPEN / CLOSE button  on the remote control (or front panel) to eject the disc tray. Load a disc, label side up, onto the disc tray and press OPEN / CLOSE button.

Automatic playback

The unit will take a few seconds to load the disc's initial data, display the disc type logo on the left upper corner on screen, and then start playing back automatically.

NOTE Normally, when a MP3 disc is loaded, the player will take longer time to load.

If a DVD disc menu appears on screen

 Press PLAY button on the remote (or on the unit) to start playing.

 Press the ARROW buttons to select the desired feature in the menu. And then press ENTER button to confirm a selection in the menu.

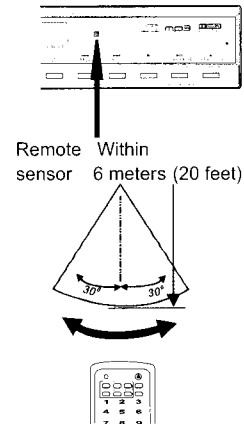

Problem disc messages

The following message will display on screen when there is a format problem with the loaded disc:

“WRONG REGIONAL DISC ”

Region code of the disc is not matching to the player's (region 1 to region6).

“WRONG PASSWORD ”

The rating level of the disc is higher than the rating level setting of the player,
The player will not play the disc.

“WRONG DISC ”

The player is equipped with automatic disc quality detection software. When the player detects a problem or damaged disc, the unit may play the disc at a lower quality or stop completely, depending on the damaged level of the disc.

Production qualities of DVD discs vary, some discs may deviate from the industry standard. Some incorrectly formatted discs may play. However, the playback and operational quality may be substandard.

DTS DISC

For DTS digital audio stream only
No analog audio output.

This player does not have a DTS decoder built-in. It may result in no analog audio output if you select DTS sound output.

- Make sure you select Dolby 5.1 or 2 channel down mix instead of DTS setting.
- Connect the digital audio output (coaxial) to a digital amplifier, in order to enjoy DTS audio system.

Power management

If the player will not be in use for a long period of time, unplug the player for safety.

An On Screen Display (OSD) indicator will be displayed at the upper part of the TV screen when certain functions are executed, or when pressing the OSD button on the remote control.

The OSD indicator is a user friendly interface designed to display the status of playback type. When a different disc is loaded (DVD, CD, MP3), the OSD indicator bar will be different.

The OSD bar will appear automatically if it is activated by pressing the OSD button. Press the OSD button again and a new status bar will appear. Press OSD button a third time and the OSD bar will disappear. When OSD indicator bar appears, press other button, the OSD indicator bar will disappear automatically.

DVD mode-OSD

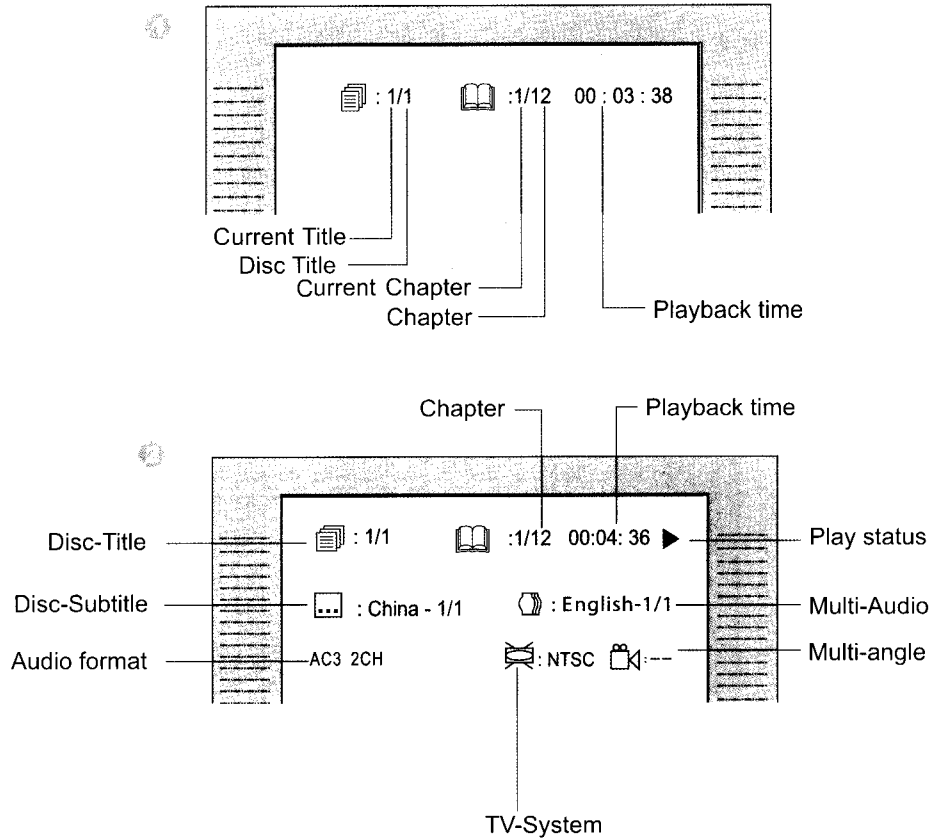

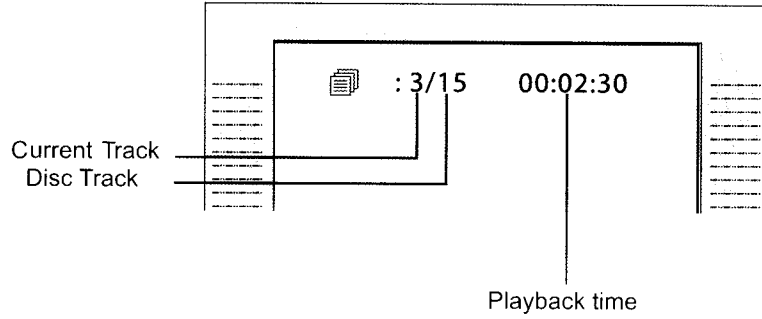

ON SCREEN DISPLAY

CD mode-OSD

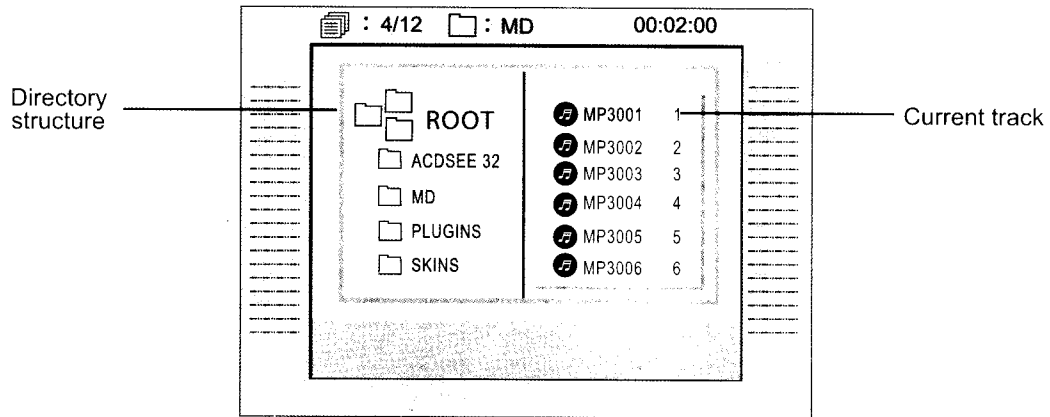

MP3 mode-OSD





OSD  Press OSD button.
To show the time and status information.

Open/Close Disc Tray  To open and close the disc tray.
Press OPEN button on the front panel or the remote.

Play/Pause/Stop

 Press PLAY button to play the disc.

 Press PAUSE button to pause(still Picture).

 Press PLAY button to resume normal playback.

 Press STOP button to stop in two modes.
a) Press the STOP button once and the STOP function memorizes the position. The OSD will show "Prestop". Press the PLAY button to resume playback.
b) Press the STOP button twice to completely Stop disc.the OSD shows "STOP". Pressing PLAY will start the disc from the beginning.

Skip Forward/Backward

 Press **▶▶** button to skip advance DVD chapter or CD track.

 Press **◀◀** button to skip backward DVD chapter or CD track.

NOTE
Player will not skip forward or backward during "WARNING" section of a DVD disc.
Single chapter DVD or single track CD cannot skip.

Fast forward/backward

 Press **▶▶▶** button to fast forward through the disc. Repeatedly pressing the button will increase the search speed.
Normal → X2 → X4 → X8 → X16 → X32

 Press **◀◀◀** button to fast backward through the disc. Repeatedly pressing the button will increase the search speed.
Normal → X2 → X4 → X8 → X16 → X32

 Press PLAY button to resume normal playback.

NOTE
The player is muted in fast forward or fast backward mode.
Player will not fast forward or fast backward during WARNING section of a DVD disc.

Slow  The player is muted in SLOW mode.

Press SLOW button to play at slow motion.Repeatedly pressing the button will decrease the slow speed.
Normal → X1/2 → X1/4 → X1/8 → X1/16 → X1/32

DISC TITLE/ MENU

MENU  While playing a DVD,
Press the MENU button return to the DVD disc start menu.

 Press PLAY button to resume play from where you previously stopped it.

TITLE  While playing a DVD, press the TITLE button return to the beginning of the DVD disc.

NOTE
Some DVD disc refuse the TITLE function.

FUNCTION BUTTONS

Select an item in the menu

In the DVD disc start menu or in the player's Set Up Menu



Press DIRECTION button to highlight function icons.



Press ENTER button to confirm a selection.

CLEAR



Press CLEAR button to cancel an entry.

RETURN



Press RETURN button returning to the upper level menu.

Numeric Key Pad

(Random Program access)

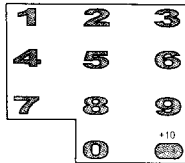

1) To directly access a DVD Chapter or a CD track, input the desired DVD Chapter or CD Track number using the numeric key pad.

2) Input data for the DVD disc start menu or the player's setup menu.

NOTE

Some DVD discs do not allow direct access function.

MUTE



Press MUTE button to select mute on or mute off.

Goto

To search for a desired Title, Chapter, Time or Track.

GOTO



In DVD mode pressing the GOTO button once appears

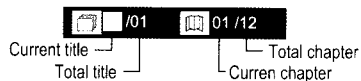

pressing the button twice appears GOTO

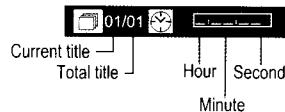

Press ENTER button to execute the search.

NOTE

Some DVD and MP3 discs do not allow the Search function to be performed during program play.

Repeat section A-B

To repeat playback a specific section of a disc.

A-B



Press the A-B button at the starting point of the desired section. "A" display on screen.

A-B



Press the A-B button again, at the end of the desired section, "A-B" display on screen. The play will start repeating playback the desired section from A to B until the function is cancelled.

A-B



To cancel the function. Press the A-B button again return to normal play.

NOTE

Some DVD discs do not allow the A-B function playback. This function does not apply to MP3 discs.

Repeat

This function allows repeated playback of a Title, Chapter or Track.

REPEAT



Press REPEAT button repeatedly to select the repeat mode.

In DVD mode

REP. CHAPTER

REP. TITLE

REP. DISC

REP. OFF

In CD mode

REP. TRK

REP. DISC

REP. OFF

In Mp3 mode

REP. TRK

REP. FOLDER

REP. DISC

REP. OFF

Repeat chapter

Repeat title

Repeat all disc

Repeat off

Repeat track

Repeat disc

Repeat off

Repeat track

Repeat folder

Repeat disc

Repeat off

NOTE

Some DVD discs do not allow REPEAT function.

Multi - Angle / Subtitle / Audio

- ANGLE** While playing back a DVD disc , press ANGLE button to view different camera angles on the disc. A DVD disc may contain up to 9 selectable camera angles.
- SUB TITLE** While playing back a DVD disc , press SUBTITLE button to select the language of the viewable subtitle. A DVD disc may contain up to 32 selectable subtitles.
- AUDIO** While playing back a DVD disc , press AUDIO button to select the language of the audio sound track. A DVD disc may contain up to 8 selectable audio sound tracks.

NOTE Some DVD discs do not have multiple ANGLES, SUBTITLES or AUDIO features.

Volume Up / Down

-  While playing back a disc, press the VOLUME button - or + to adjust the volume output. Volume level will display on screen.

VOLUME 16

The Volume level control does not apply to digital audio output level when a DVD disc is playing.

- STEP** (STEP)---Press STEP button when playing, it steps frame by frame. Press PLAY button to quit the STEP mode.

- PLAYING DVD**
ZOOM Press the ZOOM button repeatedly and the TV Screen will display:
ZOOM X2 --> ZOOMX4 --> ZOOMX1

- PLAYING JPEG**
Press the ZOOM button repeatedly and the TV Screen will display:
25%-->50%-->100%-->150%-->200%
While at 100%, press the direction button to rotate picture.
While at 150% or 200%, press the direction button to move the picture position.

NOTE The picture quality decreases as the picture size increases.

SETUP

- SETUP** Press the SETUP button to enter the player's setup menu.
The Set Up Menu allows the viewer to adjust the setting details of the player .Please read the SET UP MENU contents of the manual, for further directions on how to utilize the Set Up Menu.

PROGRAM

- To program play a disc in a desired sequence.
PROG In PBC off mode, Press PROG button to enter the program menu.

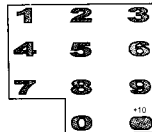

- In DVD mode**
When the program menu appears , input the Title number and press ENTER. input the Chapter number and press ENTER button to complete the programming.

ENTER



- (PLAY)---Press PLAY button to start program play.

CLEAR



- (CLEAR) --- Press CLEAR button to cancel incorrect input information. Press CLEAR again to cancel all tracks.

PROG



- (PROG)--- Press PROG button to quit the program menu.

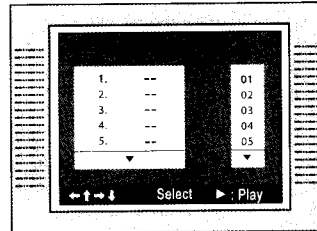



ENTER

In CD mode

- When the program menu appears, input the Track number and press ENTER to complete the programming.

 (PLAY)---Press PLAY button to start program play.

 (STOP)---Press STOP button twice to quit the program mode.

 (CLEAR)---Press CLEAR button if you want to cancel the wrong information you input before or cancel the desired track. Press CLEAR again to cancel all the tracks.

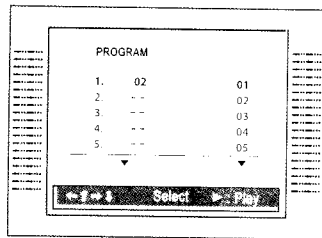

In MP3 mode

 When the program menu appears, press up/down CURSOR button to select the desired track and then press right CURSOR button to confirm.

 (PLAY)---Press PLAY button to start program play.

 (STOP)---Press STOP button twice to quit the program mode.

 (CLEAR) --- Press CLEAR button to cancel incorrect input information or cancel the desired track. Press CLEAR again to cancel all tracks.

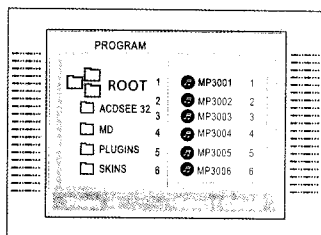

NOTE

Some DVD discs do not allow program setting. Neither single track nor mp3 disc can be programmed.

Various features of the player can be adjusted in the SETUP menu:

1. Press SETUP button **SETUP**
SETUP menu appears.

2. Press the UP/DOWN button to highlight the desired menu.

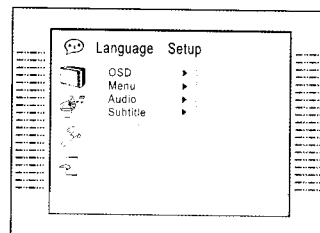
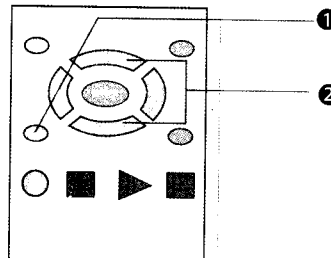

NOTE

Make sure the DVD player is in STOP mode before selecting items in the Set Up Menu.

LANGUAGE MENU

In STOP mode, press SETUP button. SETUP
 Highlight LANGUAGE with the directional keys and press ENTER. The screen will display the submenu.

Press the directional keys to highlight the desired LANGUAGE menu.

Press **ENTER** to confirm your selected item.
 OSD → ENGLISH

Select the player's OSD.

Press **ENTER** to confirm the selection.

Press SETUP button **SETUP** to quit.

Default setting ENGLISH

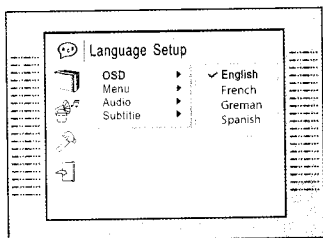

MENU → ENGLISH
 CHINESE
 JAPANESE
 FRENCH
 GERMAN
 ITALIAN
 SPANISH
 PORTUGUESE
 INDIAN
 THAI
 RUSSIAN
 KOREAN

Select the disc language setting.
 Press **ENTER** to confirm the selection.
 Press SETUP button **SETUP** to quit.

Default setting English

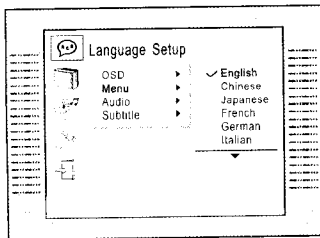

AUDIO

Select the disc audio setting.

Press **ENTER** to confirm the selection.

Press SETUP button **SETUP** to quit.

AUDIO → ENGLISH
 CHINESE
 JAPANESE
 FRENCH
 GERMAN
 ITALIAN
 SPANISH
 PORTUGUESE
 INDIAN
 THAI
 RUSSIAN
 KOREAN
 OTHERS

Default setting ENGLISH

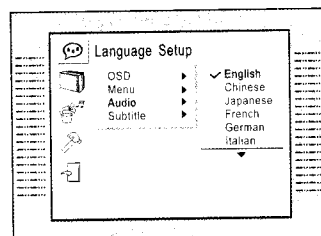

SUBTITLE → ENGLISH
 CHINESE
 JAPANESE
 FRENCH
 GERMAN
 ITALIAN
 SPANISH
 PORTUGUESE
 INDIAN
 THAI
 RUSSIAN
 KOREAN
 OTHERS
 OFF

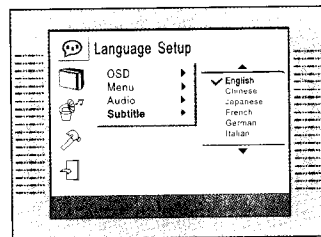

Select the disc subtitle setting.
 Press **ENTER** to confirm the selection.
 Press SETUP button **SETUP** to quit.

Default setting English



SETUP MENU(Press SETUP button)

SCREEN MENU

In STOP mode, press SETUP button  to highlight SCREEN SETUP.
Press directional keys  to highlight the desired item in the SCREEN menu.
Press  to confirm the selection.

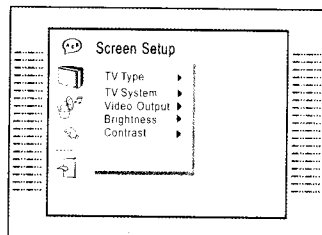

Adjust TV screen viewable format

TV TYPE → 4:3 PS (PanScan)
4:3 LB (LetterBox)
16:9 (WideScreen)

Default setting 4:3 LB

TV SYSTEM → NTSC
PAL
AUTO
Default setting NTSC

VIDEO OUT → CVBS+S+Video
CVBS+YUV
YUV P-SCAN
Default setting CVBS+S+Video



BRIGHTNESS → NORMAL
BRIGHT
SOFT
Default setting NORMAL

CONTRAST → -4
-3
-2
-1
0
1
2
3
4
Default setting 0

NOTE



- 1.Certain DVD discs are formatted in wide screen (16:9) or letter box (4:3) only. Adjusting the setting of the disc player will not alter the screen size for these "Format-only" discs.
- 2.The PS/IS Button on remote control, in normal status uneffect.
- 3.If the TV without Y Cb Cr function, please do not set from normal to Y Cb Cr

AUDIO SETUP

In STOP mode. Press SETUP button  to highlight AUDIO SETUP.
Press  to enter next sub-menu.

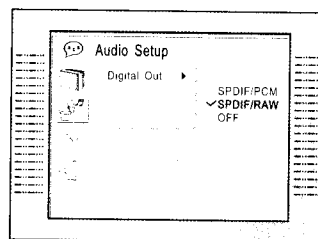
OUTPUT



Press  to confirm the selections, or
Press SETUP button  to quit.

Default setting SPDIF/RAW

NOTE

When digital output is NOT in use, it is recommended to turn "OFF" the digital output setting for the purpose on minimizing circuit interference.

CUSTOM SETUP

After entering the main menu, select and confirm "CUSTOM setup" and then the following window will appear on the TV screen.

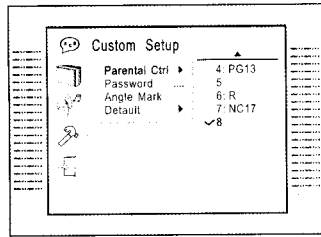

A) " Parental Ctrl "

There are 8 levels of Parental Control, as follows:
Level one opens discs to people of all ages. Level eight is suitable only for adults.
If you want to change the Parental Control setting, enter the level number and then the four digit pass code. The default code is 8888. (If you are using the player for the first time, there is the code that is needed.) When the input code has been confirmed, the level setting menu will appear. Move the cursor to the appropriate level and press ENTER to confirm. Press Set Up to exit the Menu.

B) " PASSWORD "

Move the cursor to the PASSWORD prompt and press ENTER. Input the password 8888 if this is your first use. After confirmation, you will be required to input a new 4 digit pass code. After entering your new pass code, press ENTER to confirm.

WARNING: Please keep a copy of the new pass code in a safe place, otherwise you will not be able to change the Parental Control. Please remember your Password, as the DEFAULT setting will revert everything BUT the PASSWORD to the factory defaults.

C) " ANGLE MARK "

You can choose to have the ANGLE MARK function ON or OFF. In the ON mode, an ICON will display on the screen when a disc has multiple angle shots available for viewing. Press ANGLE on the remote to enjoy these scenes.

D) " DEFAULT "

This function allows you to change the player back to the factory default settings. All settings will be changed back to the original settings. If you have changed the default PASSWORD of 8888, this will not revert.

Should your DVD player develop a problem, please check below before requesting service:

Symptom	Check and Action
No Power	<ul style="list-style-type: none"> • Make sure the unit has been powered on manually. • Check if the power cord has been properly connected to the power outlet. • Check if the main power has been switched on.
Does not play	<ul style="list-style-type: none"> • No disc, load a disc. • Disc has been loaded upside down. Place the disc with the label side up. • Disc's region code does not match to the player's. • Disc's rating level is higher than the player's setting. • Disc is incorrect type for the player. • Disc is damaged or dirty. Clean the disc or try another one. • Moisture may be condensed inside the player. Remove the disc and leave the unit power on for one or two hours.
No Picture	<ul style="list-style-type: none"> • Check if the TV set has been powered on, use TV remote to select A/V signal for DVD rather than broadcast. • Check if the system connection is proper and secure. • Check if the connection cables are damaged. • Clean the disc. • Please press OPEN button, then press PROGRAM and ZOOM button to return factory default status.
Picture noisy / distorted	<ul style="list-style-type: none"> • The disc is dirty or damaged. Clean the disc or try another disc. • Reset the color system of the TV set. • Make sure the DVD is not connected through a VCR, Cable or Satellite dish.
Picture not full screen	<ul style="list-style-type: none"> • Select the screen format from the player's Set Up Menu. see " Set Up Menu. " of this manual. • Select the screen setup from DVD disc menu.
Problem message displayed on screen	<p>Following messages will be displayed when there is a problem with the loaded disc:</p> <ul style="list-style-type: none"> • "<u>WRONG REGIONAL DISC</u>": Disc's region code does not match to the player's • "<u>WRONG PASS WORD</u>": The player refuses to play a disc with a rating level higher than the player's rating level setting. • "<u>WRONG DISC</u>" : The player is equipped with automatic disc quality detection software. When the player detects a problem or damaged disc, the player may keep playing the disc at lower quality or stop playing, depending on the damage level of the disc.
Malfunction	<ul style="list-style-type: none"> • Press and hold the standby button (if any) for about 5 seconds to power off. • Should the player develop a malfunction, unplug the player for 30 minutes. After 30 minutes, power on the player and the restore function should reset the player.



CAUTION : To reduce the risk of fire and electric shock, do not remove the cover (or back) of the unit. Refer servicing only to qualified service personnel.

Symptom	Check and Action
Cannot SKIP or SEARCH	<ul style="list-style-type: none"> • Some discs are programmed that do not allow users to SKIP or SEARCH at some sections, especially at the beginning WARNING section. • Single Chapter disc cannot apply SKIP function.
No sound or sound output not complete	<ul style="list-style-type: none"> • Check if the TV and Amplifier have been switched on, and correctly set. • Check if the TV and Amplifier system connections are secured. • Press AUDIO button to select other audio tracks output of disc. • Check if the MUTE function of the TV or Amplifier has been activated. • There will be no sound output during REVERSE PLAY / PAUSE / STEP / SLOW and SEARCH.
MP3 disc no sound or noisy	<ul style="list-style-type: none"> • When PC program files or other data files are mixed with MP3 files in the same disc, the player may play the non-MP3 files with noise or no sound. • Check the disc, if all the files on disc are MP3 files. Skip the file and try other ones.
Remote control does not function	<ul style="list-style-type: none"> • Make sure the Power button on the unit has been turned on manually. • Remove the obstacles between the remote control and the player. • Point the remote control towards the remote sensor on the player. • Check if the batteries of the remote control have been loaded with correct polarities. • Replace the batteries of the remote control.
Type of Disc	<p>DVD CD-DA CD-MP3 CD-R / CD-RW</p>

Video Format	MPEG 2
Audio Format	MPEG 1, LAYER 1, LAYER 2, LAYER 3
Signal Output	Color System: PAL / NTSC Audio System: DOLBY DIGITAL down mix stereo DOLBY DIGITAL digital output Audio DAC 18bit/48KHz Video Output: 1Vpp (at 75ohm) Audio Output (Stereo): 2Vrms (1KHz, 0dB)
Frequency Response	CD: 2Hz-20KHz(EIAJ) DVD: 4Hz-22KHz(48K) 4Hz-22KHz(96K)
S / N ratio	CD audio: 115dB(EIAJ)
THD	CD audio: 0.01%(EIAJ)
Output Terminals	Video (composite) output x 1 S-Video output x 1 component Video (Y Pb/Cb Pr/Cr) output Down Mix Stereo output (Left and Right) x 1 Digital audio (coaxial) output x 1
Power input	AC110-240V~50/60Hz 20W(Max.)
Dimensions	Body size: 270x180x48mm Packing size: 340x316x95mm Net weight: 1.8kg
Pickup	Wave length: 655nm
Laser power	CLASS1
Accessories	Subwoofer(1 pcs) Speakers (2 pcs) 

Free Manuals Download Website

<http://myh66.com>

<http://usermanuals.us>

<http://www.somanuals.com>

<http://www.4manuals.cc>

<http://www.manual-lib.com>

<http://www.404manual.com>

<http://www.luxmanual.com>

<http://aubethermostatmanual.com>

Golf course search by state

<http://golfingnear.com>

Email search by domain

<http://emailbydomain.com>

Auto manuals search

<http://auto.somanuals.com>

TV manuals search

<http://tv.somanuals.com>