

6700001

Model 670, 678

Hot Drink

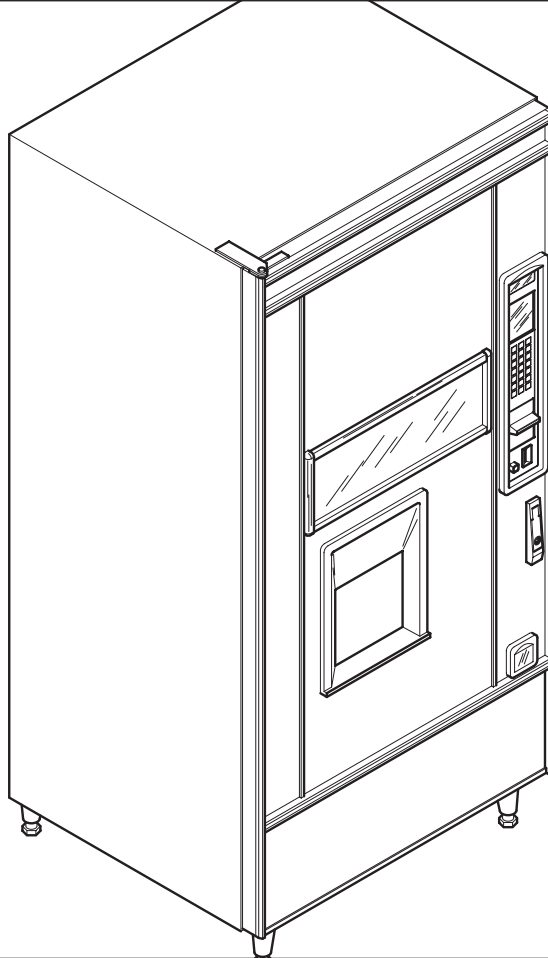

Set-Up / Programming Guide

CRANE MERCHANDISING SYSTEMS A Crane Co. Company

12955 Enterprise Way
Bridgeton, Missouri 63044-1200
(314) 298-3500
www.CraneMS.com



Copyright© 11-02

6700001

This machine has been engineered to our own rigid safety and performance standards. It has been designed to comply with sanitation and health guidelines recommended by the Automatic Merchandising Health-Industry Council (AMHIC) and it conforms with all other NAMA safety recommendations.

This machine has been manufactured in accordance with the safety standards of both Underwriter's Laboratories and the Canadian Standards Association. To maintain this degree of safety and to continue to achieve the level of performance built into this machine, it is important that installation and maintenance be performed so as to not alter the original construction or wiring and that replacement parts are as specified in the Parts and Service Manual. Your investment in this equipment will be protected by using this Operator's Guide and the Parts and Service Manual in your operation, service and maintenance work. By following prescribed procedures, machine performance and safety will be preserved.

This Merchandiser is warranted for one (1) year against defective parts and workmanship. Any part or parts which are proven to be defective within one (1) year of the date of shipment will be repaired or replaced free of charge when the defective part is returned, with transportation charges prepaid, to the destination designated by the National Vendors Warranty Department.

This warranty applies only to the original purchaser of the Merchandiser and is null and void if the Merchandiser is sold during the period of warranty.

This warranty does not apply to a) electrical components, wiring, or circuits and/or for all mechanical parts or assemblies damaged as a result of operating the Merchandiser at other than the design voltage and frequency specified on the Electrical Rating Tag, or b) in event of vandalism, fire or negligence, or c) incandescent lamps, neon lamps, fluorescent lamps, ballasts, starters or other expendable items or d) when other manufactured components are installed in National Vendors Merchandisers.

National Vendors is not responsible for any cost of service rendered or repairs made by customer or its agents on Merchandiser or parts unless authorization to incur such expense has been given in writing by National Vendors prior to incurring such expense.

THIS WARRANTY IS IN LIEU OF ALL OTHER WARRANTIES EXPRESSED OR IMPLIED, INCLUDING WITHOUT LIMITATION, WARRANTIES OF MERCHANTABILITY OR FITNESS FOR A PARTICULAR PURPOSE. NATIONAL VENDORS SHALL NOT BE RESPONSIBLE FOR CONSEQUENTIAL OR PUNITIVE DAMAGES. National Vendors neither assumes nor authorizes any person to assume for it any obligation or liability in connection with the sale of said equipment or any part thereof.

HOT DRINK SETUP/PROGRAMMING GUIDE

TABLE OF CONTENTS

TABLE OF CONTENTS

SPECIFICATIONS V
MAJOR PARTS VII
CONTROLS AND INDICATORS XI
I. LOCATION PREPARATION 1
 Electrical Power Requirements 1
II. POSITIONING THE MERCHANDISER 3
III. CONNECTING EVERYTHING 3
 1. Connect the Merchandiser to the Water Supply 3
IV. FINAL MECHANICAL PREPARATION 4
 1. Level the Merchandiser 4
 2. Mount the Base Plate 5
 3. Install the Water Filter Cartridge 6
 Hydrolife Brand 8
 Installation 8
 Removal 8
 Load the Optional Filter Paper 9
 (CONTINUED) 9
 Replace The Cup Station And Grounds Bucket 11
 Install The Optional Coin Box Lock 11
 Set Up And Load The Coin Mechanism 12
 Standard Coin Mechanism 12
 MDB Coin Mechanism 12
 Fill The Tank 14
 Fill The Canisters 14
 Load Cups 15
 Cup Size(s) 16
 Set Prices 17
 Set Up The Menu 17
 Establish Time Of Day Vending Periods 17
 Customize The Drink Recipes 17
 Set Up Custom Messages 17
 Posivend™ 17
V. ADJUSTMENTS AND MINOR MAINTENANCE 19
 1. Empty the Bill Stacker 19
 2. Adjust the Water Valves 19
 3. Adjust the Air Pressure 20
 4. Install Canisters 20
 5. Adjust the Cup Mechanism 21
 VIEW A 21
 VIEW B 21
 6. Set Up the Menu Assembly 22
GETTING AROUND 23
THE SERVICE KEYPAD 23
THE SELECTION SWITCH PANEL 23
PROGRAMMING THE HOT DRINK 23
THE DISPLAYS 24
THE FUNCTION KEYS 25
OTHER KEYS 25

HOT DRINK SETUP/PROGRAMMING GUIDE

III. CONTROL PANEL SWITCHES EXPLAINED	26
PROGRAMMING PROCEDURES	28
THE SUPERVISOR MODE	28
GAIN ACCESS TO THE SUPERVISOR MODE	29
ENTER A NEW SUPERVISOR CODE	29
ENTER A FREEVEND CODE	29
THE SUPERVISOR MODE	29
LOCK OR UNLOCK MODE OR PAYOUT KEYS	30
SET PRINTER OR DEX OPTIONS	30
LOCK OR UNLOCK DATA CLEARING ACCESS	31
SELECT DISPLAY LANGUAGE	31
SELECT COIN MECHANISM AND OPTIONS	32
SELECT BILL VALIDATOR AND OPTIONS	33
BILL LIST OPERATION	33
SELECT MONETARY OPTIONS	35
SELECT CARD READER AND OPTIONS	37
SET UP WINNER MODE	38
ADVANCED OPTIONS	38
SET UP THE MUG DISCOUNT	39
SET THE PRINTER BAUD RATE	39
LOCK OR UNLOCK SELECTIONS	40
DISABLE SELECTIONS IN THE MERCHANDISER	40
ASSIGN CUP SIZES TO SELECTIONS	41
(SUPERVISOR MODE ONLY)	41
SET UP A HOT DRINK	42
WHIPPER OPTIONS	43
DIFFERENCES(OPTIONS)	44
VIEW OR SET THE HOT WATER TANK TEMPERATURE	44
SET UP LOW TEMPERATURE DISPENSING	45
TSET UP LOW POWER SETTINGS	45
SET THE RATIO OF CHOCOLATE IN CAPPUCINO	47
SET THE BREWER RINSE TIME INTERVAL	47
THE BOWL RINSE TIME	48
TURN POSIVEND™ ON OR OFF	48
OPTIONAL OR MANDATORY POSIVEND™	49
SET UP THE POSIVEND™ ANTI-JACKPOT TIMER	49
VIEW NUMBER OF MUG VENDS	50
VIEW MACHINE ID NUMBER	50
VIEW CUP RING CYCLES RELATED TO POSIVEND™	50
VIEW TIMES NO CUP WAS DETECTED AFTER A CUP RING CYCLED	51
VIEW HOME SWITCH USAGE RELATED TO POSIVEND™	51
VIEW POSIVEND™ LAST RECORDED CALIBRATION	52
VALUE	52
VIEW POSIVEND™ AVERAGE CALIBRATION VALUE	52
CONTINUE	52
CLEAR TANK ERRORS AND FILL THE TANK	52
SET THE MACHINE TYPE CONFIGURATION CODE	53
SET UP THE CUP ONLY OPTION (SUPERVISOR MODE ONLY)	55
SET UP DELIVERY DOOR OPTIONS (SUPERVISOR MODE ONLY)	55

HOT DRINK SETUP/PROGRAMMING GUIDE

COLLECTING DRY PRODUCT GRAM THROWS	56
DRY PRODUCT WEIGHT AND THROW TIME FACTORY DEFAULT	
SETTINGS	57
CAPPUCCINO RECIPE	59
CAPPUCCINO	59
MOTOR SPEED BY LOCATION	60
HINTS	60
CAFFÉ LATTE RECIPE	64
CAFFÉ LATTE	64
ENTER THE SUPERVISOR CODE	64
SET THE MACHINE TO VEND A LARGE "D" SELECTION	64
SET UP YOUR SELECTION	65
EUROPEAN CAPPUCCINO	65
RECONFIGURE THE MACHINE	65
COLLECTING WATER THROWS	67
EUROPEAN CAPPUCCINO RECIPE	67
WATER THROW DEFAULT TIMES AND VOLUMES	68
SET PRICES FOR INDIVIDUAL SELECTIONS	69
SET THE PRICE FOR A CUP ONLY	70
SET ONE PRICE FOR THE ENTIRE MACHINE	70
SET ONE PRICE FOR ALL REGULAR SIZE DRINKS	70
SET ONE PRICE FOR ALL LARGE SIZE DRINKS	71
SET THE TIME	71
SET THE DAY OF THE WEEK	71
SET THE DATE AND YEAR	72
SET TIME-OF-DAY INHIBITED VENDING	72
SET TIME-OF-DAY DISCOUNT VENDING	73
SET TIME-OF-DAY FREE VENDING	73
TIME INTERVAL EDITING	74
STAND BY	75
SELECT A STANDBY MESSAGE	76
SELECT AN OUT-OF-SERVICE MESSAGE	77
SELECT A FREEVEND MESSAGE	77
EDIT CUSTOM MESSAGES	78
THE END OF MESSAGE CHARACTER	78
ENTERING YOUR MESSAGE	79
THE CHARACTER SET	79
TEST VEND SELECTIONS AND VERIFY CREDIT ADDED	80
TEST THE DISPLAY	80
TEST THE CUP MECHANISM	81
TEST THE AUTOMATIC DOOR (OPTIONAL)	81
TEST THE WHIPPERS	81
TEST THE AIR COMPRESSOR	82
TEST THE BREWER	82
RINSE ALL MIXING BOWLS	83
VIEW FREEVEND SALES BY TIME INTERVAL	83
VIEW DISCOUNT SALES BY TIME INTERVAL	84
VIEW FREE VENDS	84
VIEW WINNERS	85
VIEW TIME DATA	85

HOT DRINK SETUP/PROGRAMMING GUIDE

VIEW TOTAL UNPAID SALES	87
VIEW TOTAL UNPAID VENDS	87
VIEW NUMBER OF TEST VENDS	87
VIEW SALES DATA BY PRICE	87
SET FREEVEND OPTIONS	88
NO MONEY REQUIRED	88
VIEW MACHINE ID NUMBER	89
VIEW NON-RESETTABLE SALES AND VEND DATA	89
VIEW DATA THREE DIFFERENT WAYS	89
RINSE THE BREWER	90
FILL THE TANK	90
TEST VARIOUS SENSORS AND SWITCHES	91
PAYOUT COINS	91
VIEW TOTAL PAID SALES	92
VIEW CARD READER PAID SALES	92
VIEW TOTAL PAID VENDS	92
CLEAR ALL RESETTABLE DATA	93
CLEAR PAID SALES DATA ONLY	93
VIEW AMOUNT IN COIN BOX	93
VIEW AMOUNT IN VALIDATOR	94
VIEW DIAGNOSTIC MESSAGES	94
DOWNLOAD DATA TO A PDCD	98
CHANGE MACHINE ID NUMBER	99
VIEW THE WATER TANK TEMPERATURE	99
VIEW THE CURRENT SOFTWARE VERSION NUMBER	99
VIEW THE SELECTION MACHINE TYPE	100
VIEW THE SELECTION CONFIGURATION	100
SANITATION	101
Basics	101
How Do I Sanitize?	101
Chemicals	101
Heat	
Food-Contact Parts	103
Non Food-Contact Parts	104
OVERALL CLEANING	104
Preventive Maintenance Cleaning	104
APPENDIX A. THE OPTIONAL PRINTER	A1
APPENDIX B. THE INFRARED MUG/CUP SENSOR	B3
Indicator Light	B3
Cleaning	B3
Calibration	B4
APPENDIX C. DEX/UCS INTERFACE OPERATION	C7
Select Data Transfer Method	C7
Download Data	C7
APPENDIX C. DEX/UCS INTERFACE OPERATION	C7
APPENDIX D. MODIFY CANISTER TO VEND 12 OZ. CUPSD9	
APPENDIX E. CLEAN THE HOT WATER TANK	E11
APPENDIX F. THE FREE VEND KEYSWITCH OPTION	F13
Using The Free Vend Key Switch	F13

HOT DRINK SETUP/PROGRAMMING GUIDE

SPECIFICATIONS

SPECIFICATIONS COMMON TO ALL MACHINES

DIMENSIONS	72" (183 cm) high 32" (81 cm) wide 28.5" (72 cm) deep
WEIGHT	475 lbs (215.5 kg)
WATER REQUIREMENTS	Minimum: 20 psi (137.8 kPa) Maximum: 80 psi (551.2 kPa)
AMBIENT TEMPERATURE	Minimum: 41° F (5° C) Maximum: 90° F (32° C)
OPERATING ENVIRONMENT	For indoor use only
CUP CAPACITIES (APPROXIMATE)	5 oz cups - 965 7 oz cups (squat) - 805 8.25 oz cups - 735 9 oz cups (squat) - 770 10 oz cups - 690 12 oz cups - 660
CANISTER CAPACITIES (APPROXIMATE)	Fresh brew coffee - 13 lbs (Model 634 only) Freeze dry coffee - 2 lbs Fresh brew decaf - 9 lbs (Model 634 only) Freeze dry decaf - 2 lbs Tea (freeze dry) 1.5 lbs Chocolate - 10 lbs Soup (or sugar substitute) - 6.7 lbs (4 lbs) Sugar - 11 lbs Lightener - 4.5 lbs
PRODUCT OPTIONS	
Model 670 Fresh Brew	Standard Configuration: Fresh brew coffee (pre-ground) Fresh brew OR freeze dry decaf Freeze dry tea Espresso, cappuccino, hot chocolate, and "cup only" selections Optional Configurations: Hot water selection Soup selection OR Sugar substitute condiment
Model 678 Freeze Dried	Standard Configuration: Freeze dry coffee Freeze dry decaf Freeze dry tea Espresso, cappuccino, hot chocolate, and "cup only" selections Optional Configurations: Hot water selection Soup selection OR Sugar substitute condiment

HOT DRINK SETUP/PROGRAMMING GUIDE

SPECIFICATIONS COMMON TO ALL MACHINES (continued)

OPTIONS	Automatic delivery door Base grille kit (1 sided) Base grille kit (3 sided) Coin box lock Data printer kit Debit card reader Door striping kit Everpure water filter kit Cuno water filter kit Hydro-Life water filter kit Soup whipper kit Flex Ace door lock and key Van door lock and key Free vend keyswitch Snap-on ingredient canister extension sleeves (4" tall) Soup or sugar substitute kit Ingredient rinse tray Cup/mug electronic sensor (cup hold switch kit) PosiVend Hot water selection kit Filter paper kit (5000 vends per roll) for brewer (Model 634 only) Choice of "Textured white" or "Textured gray" paint for cabinet door
----------------	--

SPECIFICATIONS UNIQUE TO 115 VOLT MACHINES

ELECTRICAL	115 Volts AC 60 Hertz 12 Amps Single phase
-------------------	---

OPTIONS AND ACCESSORIES

COIN MECHANISM	MARS TRC-6000 COINTRON 3000 MARS TRC-6010XV (24 V) Maka/Conlux Model USPX-004 (24 V) Coin Acceptors Model 9302-LF (24 V)
BILL VALIDATORS	MARS VFM1 pulse MARS VFM3 serial MAKA pulse COINCO MDB

SPECIFICATIONS UNIQUE TO 220 - 240 VOLT MACHINES

ELECTRICAL	220 - 240 Volts AC 50 Hertz 10 Amps 2 kW Single phase
-------------------	---

OPTIONS AND ACCESSORIES

COIN MECHANISM	Executive coin mechanism interface
-----------------------	------------------------------------

MAJOR PARTS

The diagrams on the following pages will acquaint you with the major parts of the Hot Drink merchandiser. For more detailed information, please consult your PARTS MANUAL. If you do not have a PARTS MANUAL, contact National Vendors Parts Department.

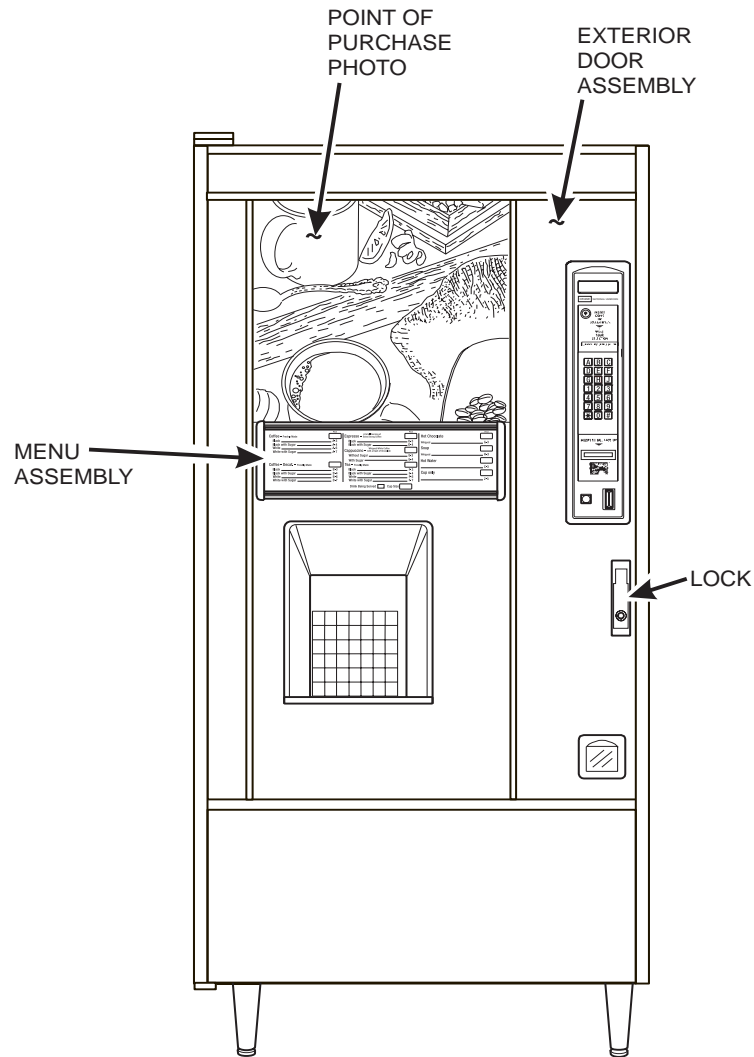

FRONT OF MERCHANDISER

HOT DRINK SETUP/PROGRAMMING GUIDE

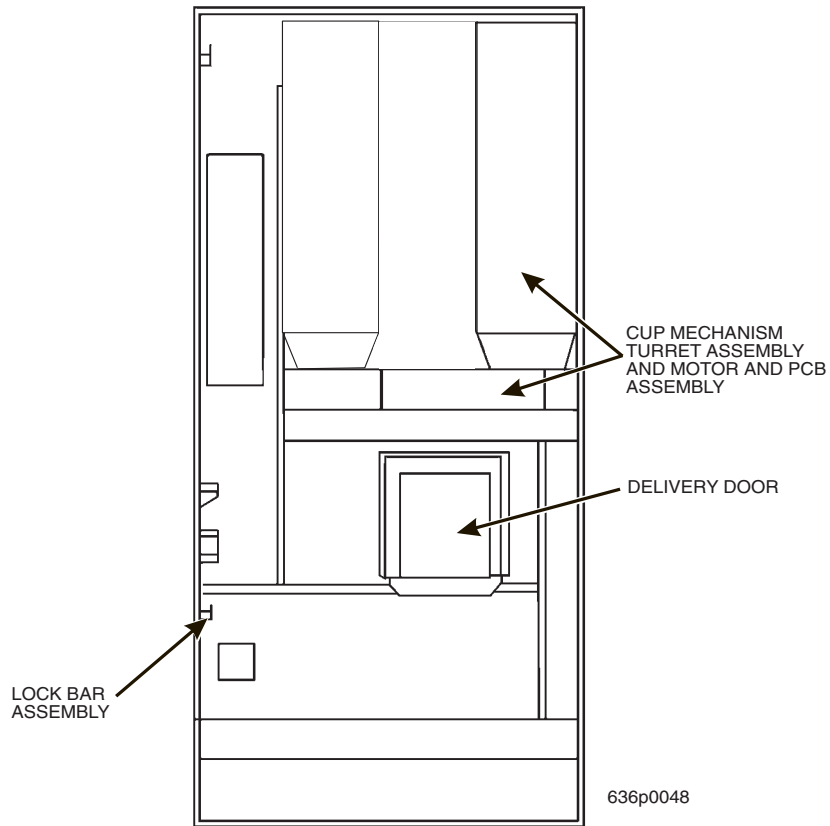

FRONT VIEW OF MERCHANDISER

BACK SIDE OF MERCHANDISER DOOR

HOT DRINK SETUP/PROGRAMMING GUIDE

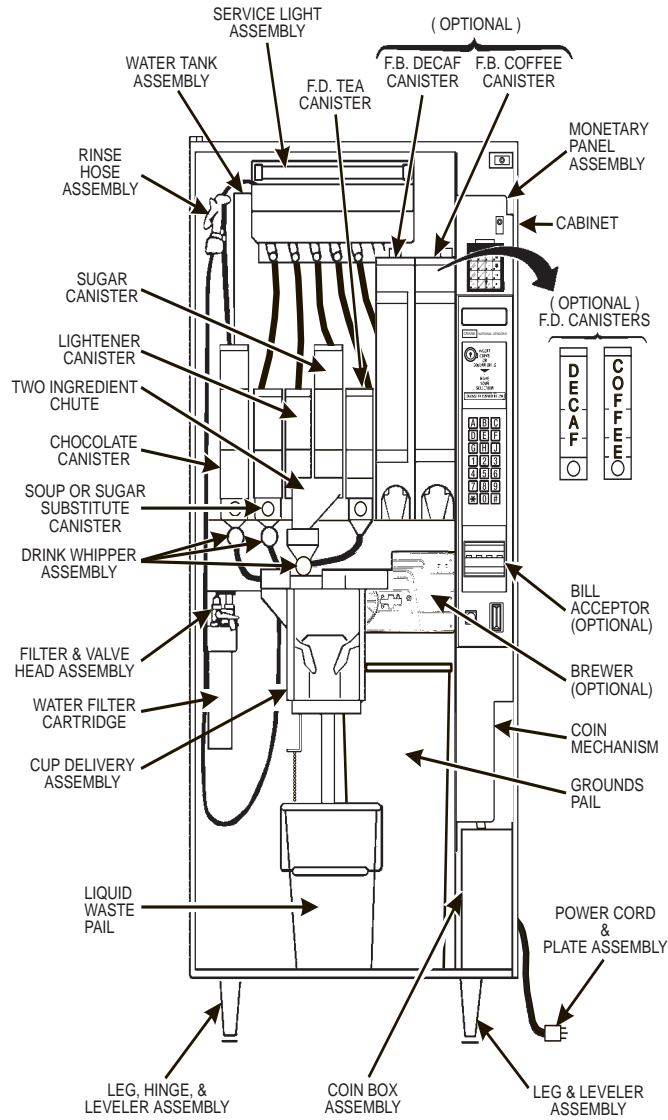

MERCHANDISER CABINET INTERIOR

HOT DRINK SETUP/PROGRAMMING GUIDE

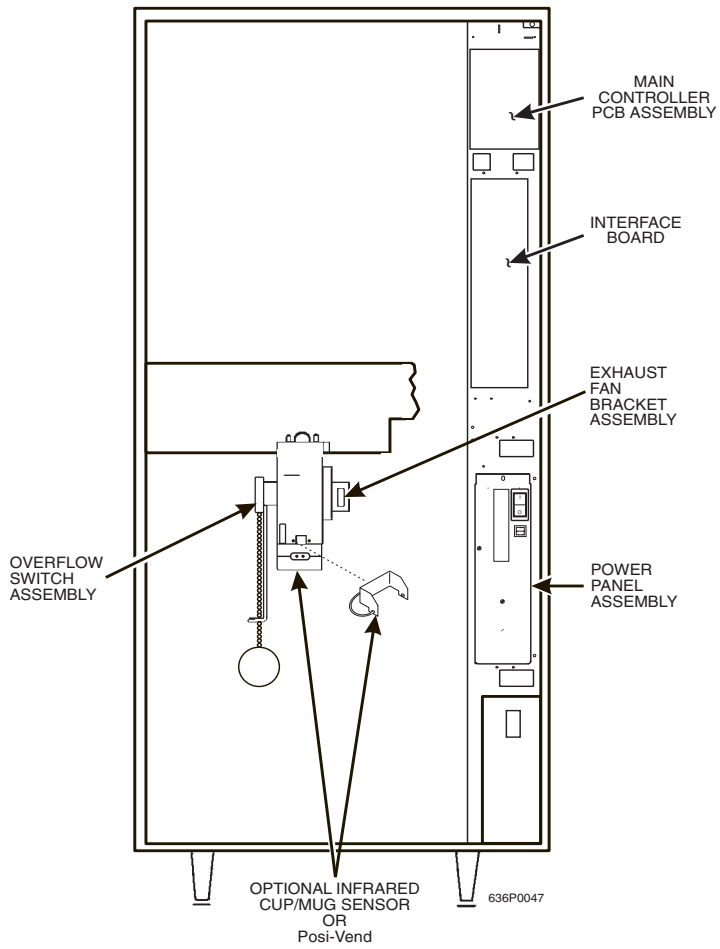

MERCHANDISER CABINET INTERIOR

CONTROLS AND INDICATORS

POWER PANEL. You may have one of three power panels, depending upon where you live. The controls are fundamentally the same, however.

Circuit Breakers. Circuit breakers protect the merchandiser against failures in the power supply or any of the electrical components. If a circuit breaker trips and cannot be reset, consult your troubleshooting manual.

Back Side of U.S./Canada Power Control Panel. The circuit board mounted on the rear of the U.S. and Canadian power control panel is a dc power supply for the coin mechanism. A fuse protects the board circuitry in the event of a coin mechanism solenoid failure. If the coin mechanism is not working, check this fuse. If the fuse is blown, a bad coin mechanism solenoid could be at fault.

Main Power Switch. This is the main ON/OFF switch for the merchandiser.

WARNING

To protect against electrical shocks and possible damage to the machine, turn this switch OFF when performing any maintenance on the merchandiser.

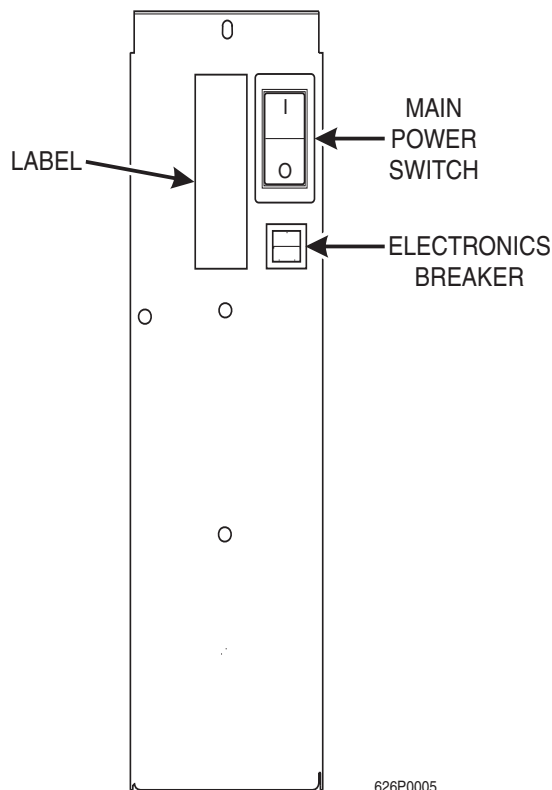

HOT DRINK SETUP/PROGRAMMING GUIDE

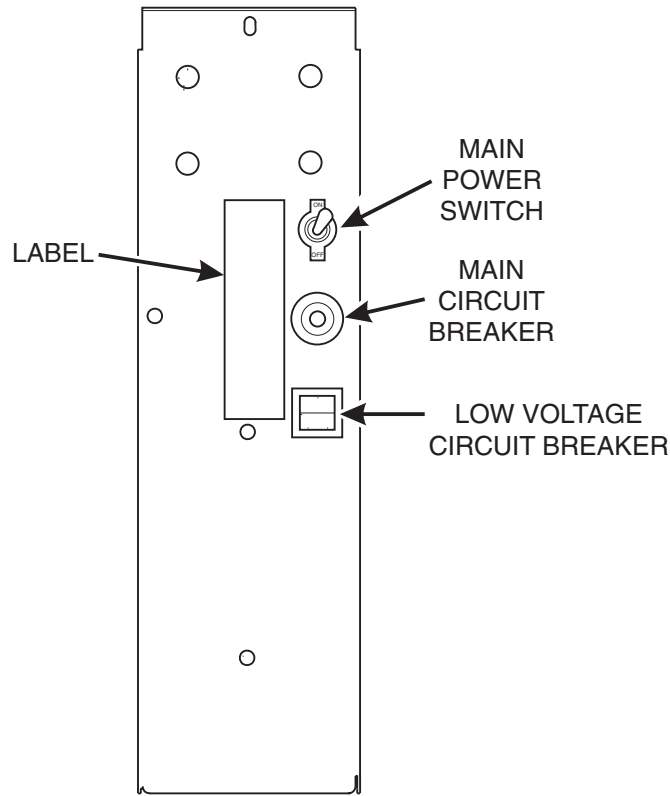

626P0006

**POWER CONTROL PANEL
(U.S./CANADA)**

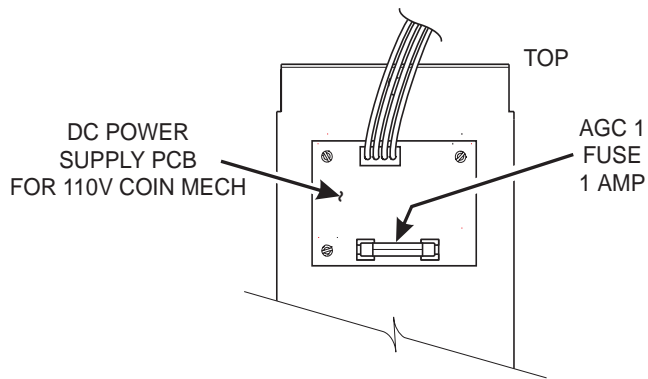

BACK SIDE OF U.S./CANADA POWER CONTROL PANEL

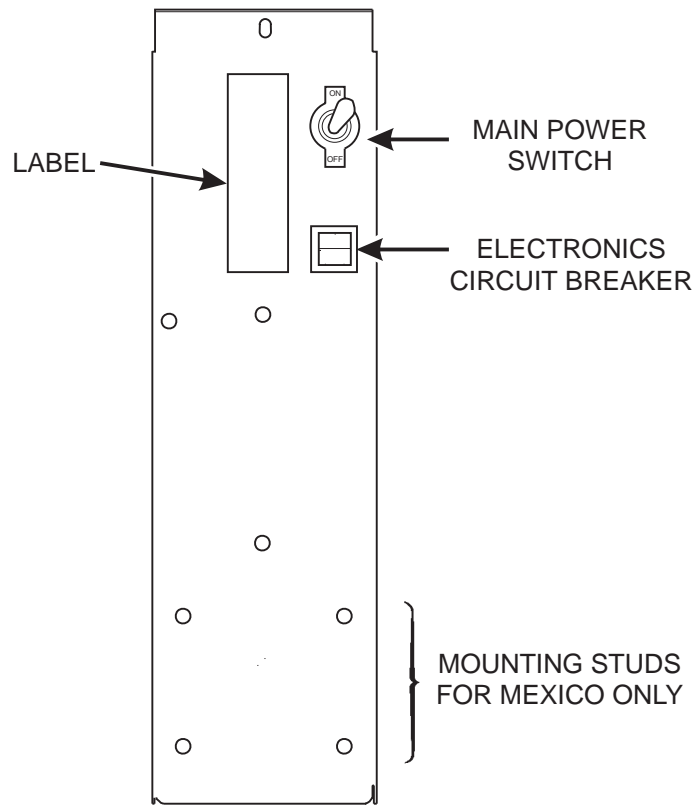

**POWER CONTROL PANEL
(U.K. / MEXICO)**

HOT DRINK SETUP/PROGRAMMING GUIDE

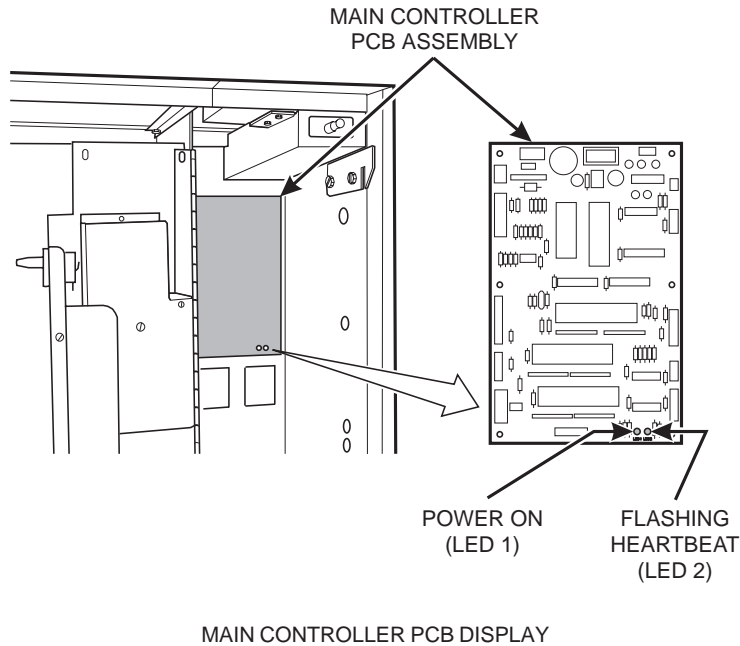

Main Controller PCB Display. This display consists of two light emitting diodes (LED) mounted on the controller PCB.

POWER ON (LED 1) When lit, this red LED indicates electrical power is applied to the controller PCB.

HEARTBEAT (LED 2) When flashing, this red LED indicates that the controller PCB is active, and the software is operating.

NORMAL CONDITIONS:

When the merchandiser is operating normally, you should see a steady red **POWER ON** indicator. The red **HEARTBEAT** indicator should be flashing with a balanced on/off pattern (on for the same length of time that it is off).

ERROR CONDITIONS:

If an error is present, the red **HEARTBEAT** indicator will flash with an unbalanced on/off pattern (on longer than it is off). The error(s) can be viewed under the **DIAGNOSTICS** mode.

HOT DRINK SETUP/PROGRAMMING GUIDE

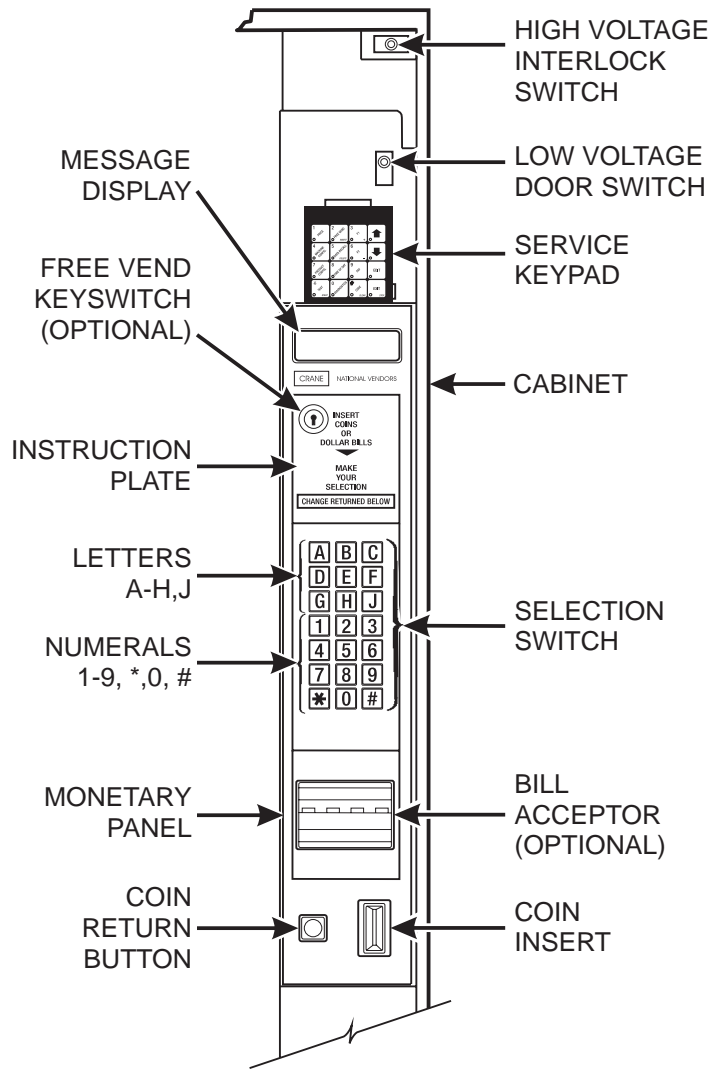

MONETARY PANEL

HOT DRINK SETUP/PROGRAMMING GUIDE

High Voltage Interlock Switch (U.S./ Canada). When the cabinet door is open, this switch turns off the optional fan and bean light (if equipped), and turns on the service light.

High Voltage Interlock Switch (International). When the cabinet door is open, this switch turns off all high voltage to the cabinet. Pulling the switch out restores high voltage for maintenance purposes.

Low Voltage Door Switch. Informs the controller software of the main door open or closed status.

Message Display. This is how the merchandiser communicates with the outside world. Customers can see messages about how much money they have put into the merchandiser. The message display also tells customers when a selection is sold out and when vending is free, inhibited, or discounted. The message display shows you what you are doing when you program the merchandiser, and can show you what is wrong if there is a failure.

Free Vend Keyswitch. This allows someone (other than maintenance people) to set the merchandiser to free vend without opening the door.

Selection Switch Panel. The customer uses these switches to make selections. Also, maintenance people may use this switch panel during programming and other support modes.

Coin Return Button. Pressing this button returns any coins that have been paid into the merchandiser prior to a vend.

Bill Acceptor (Optional). Accepts bills in various denominations, depending upon the type of bill validator, and how the machine is configured.

Service Keypad. The service keypad is located at the top of the monetary panel. It gives service personnel the means to program, retrieve data from, and view diagnostic information about, the merchandiser.

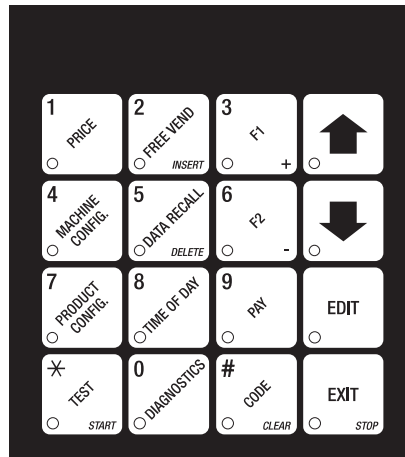

SERVICE KEYPAD

INITIAL SETUP

I. LOCATION PREPARATION

After your machine is unpacked and placed near its permanent location, you need to make sure you have the proper electrical and water service.

ELECTRICAL POWER REQUIREMENTS

This merchandiser needs electrical power as shown in the following table.

NOTE

Each merchandiser should have its own electrical circuit.

Power Requirements

Country	Volts	Frequency (Hz)	Current (Amp)
Canada	115	60	15
France	230	50	10
Germany	230	50	10
United Kingdom	230	50	10
United States	115	60	15

1. Check the Power Outlet

This merchandiser is supplied with a service cord for the country of use and is terminated in a grounding type plug. The wall receptacle used for this merchandiser must be properly polarized, grounded, and of the correct voltage. Operating the merchandiser from a source of low voltage will **VOID YOUR WARRANTY**. Each merchandiser should have its own electrical circuit and that circuit should be protected with a circuit breaker or fuse conforming to local regulations.

Voltage Check - Place the leads of a voltmeter across the LINE (LIVE) and NEUTRAL terminals of the wall receptacle. The voltmeter should indicate 110-130 volts ac for 120 volt, 60 Hz locations, or 220-240 volts ac for 230 volt, 50 Hz locations.

Polarity Check - Place the leads of a voltmeter across the LINE (LIVE) and GROUND terminals of the wall receptacle. The voltmeter should indicate 110-130 volts ac for 120 volt, 60 Hz locations, or 220-240 volts ac for 230 volt, 50 Hz locations.

Noise Potential Check - Place the leads of a voltmeter across the NEUTRAL and GROUND terminals of the wall receptacle. The voltmeter should indicate 0 volts ac. A measurement greater than 1.5-2.0 volts ac could result in problems for the merchandiser's electronic circuitry caused by electrical noise.

Any deviation from these requirements could result in unreliable performance from your merchandiser.

HOT DRINK SETUP/PROGRAMMING GUIDE

WATER REQUIREMENTS

The best type of water for coffee brewing is normal hard (tap) water. If your location has chemically softened water, you should do one of the following things:

- Have a non-softened supply line run to the merchandiser
- Contact your local water filter supplier for information and suggestions

Well water can also be used in the Hot Drink Machine. However, you should have it checked for levels of carbonates and alkalies. Contact your water filter supplier if these values are relatively high.

What is the Water Pressure at Your Location?

It should be no less than: 10 psi (69.0 KPa) at 1/2 gallon/minute

And no more than: 80 psi (522.0 KPa) at 1/2 gallon/minute

If you're not sure about the pressure and flow rate, check with your water company.

What to do With the Water Supply Line:

Locate the supply line at the rear of your merchandiser.
Equip the line with a shut-off valve.

Flush the water supply line before connecting it to the merchandiser. A minimum of five gallons is usually required before connecting the merchandiser to the supply line. **DO NOT** flush the merchandiser water system. If you do, you might introduce water line contaminants into the merchandiser.

II. POSITIONING THE MERCHANDISER

You can position this merchandiser anywhere in a bank of machines. It can even be placed on the end flush against a side wall. Be sure you leave enough room in front of the merchandiser for the door to move freely.

BESURE THE REAR OF THE MERCHANDISER IS AT LEAST 6" AWAY FROM THE WALL. THIS WILL ALLOW WARM MOIST AIR TO BE VENTED OUT OF THE MACHINE'S INTERIOR.

**WARNING:
THIS MACHINE IS ONLY RATED FOR INSTALLATION IN AN INDOOR LOCATION.**

III. CONNECTING EVERYTHING

1. Connect the Merchandiser to the Water Supply:

- a. You will need the following:
 - A coil of copper tubing with outside diameter of 3/8 inch (9.5 mm) or greater. The appropriate plastic tubing may be substituted. The tubing must be long enough to reach from the water source to your machine with enough left over to form a loop about 2 feet (60 cm) in diameter. This will allow you to move the machine without straining the water line.
 - A 3/8 inch (9.5 mm) flare fitting.
- b. Connect the merchandiser to your water supply.

2. Connect the Merchandiser to the Electrical Power Supply:

Power inside the merchandiser is controlled by the main power switch, located on the power panel.

- a. Make sure the main power switch is OFF.
- b. Connect the merchandiser's power cord to your wall outlet.

IV. FINAL MECHANICAL PREPARATION

1. Level the Merchandiser:

- a. Place a spirit level on the top front edge of the cabinet with the door fully closed. Adjust the front legs only until the cabinet is reasonably level.
- b. Hold the door open about 4 inches.

WARNING

HAVE AN ASSISTANT HOLD THE MERCHANDISER WHILE YOU ADJUST THE LEG LEVELERS.

- c. Adjust the back legs so that the back leg leveler on the hinge side is off the floor just enough so a piece of paper can slide under it with only a bit of resistance.
- d. For proper weight distribution on all four legs, raise the back leg on the hinge side by unscrewing the leveler $1\frac{1}{2}$ turns.

NOTE

You may need to use pliers or channel locks to loosen the leg levelers.

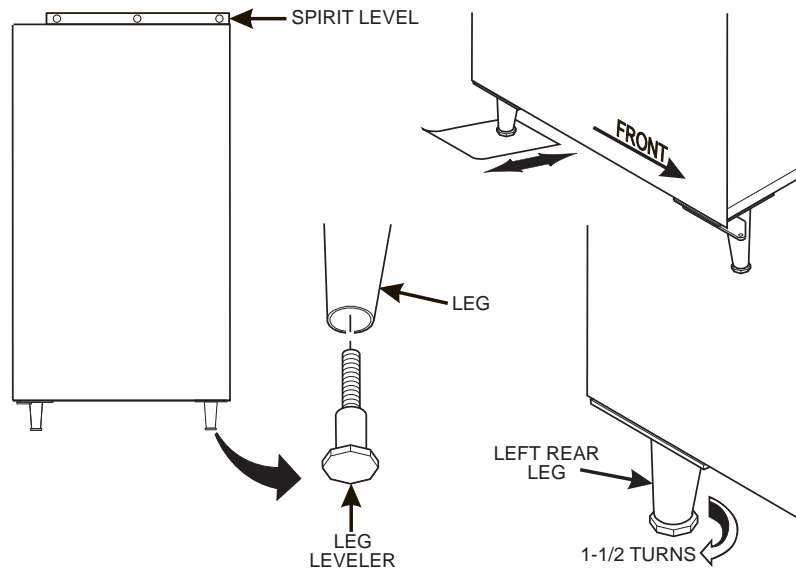

HOT DRINK SETUP/PROGRAMMING GUIDE

2. Mount the Base Plate:

WARNING

DO NOT MOVE THE CABINET WHILE HEX HEAD SCREWS AND/OR CARRIAGE BOLTS ARE LOOSENED. THE CABINET WOULD BECOME UNSTABLE AND LIKELY TO TIP AND CAUSE INJURY.

- a. Remove the pail(s) from the inside of the merchandiser.
- b. Remove the floor liner from the inside of the merchandiser.
- c. Remove the two caps as shown.
- d. Loosen the left leg assembly carriage bolts and nuts to allow mounting a base plate bracket.
- e. Secure one of the base plate brackets to the leg assembly using the two carriage bolt. Tighten the carriage bolts and nuts.
- f. Loosen the right leg assembly hex head screws to allow mounting the other base plate bracket.
- g. Secure the other base plate bracket to the right leg assembly using the two hex head screws. Tighten the hex head screws.
- h. Insert the short arms of the slides into the hinged tabs of the base plate. Position the slide so the notch near the short arm is on the bottom side.
- i. Insert the long arms of the slides into the base plate brackets.
- j. Insert and secure a cotter pin through the hole in the back of each of the slides.
- k. Push the base plate toward the merchandiser cabinet. The front tabs of the base plate brackets should seat in the notches in the long arms of the slides.
- l. Replace the caps, liner, and pail(s) removed previously.

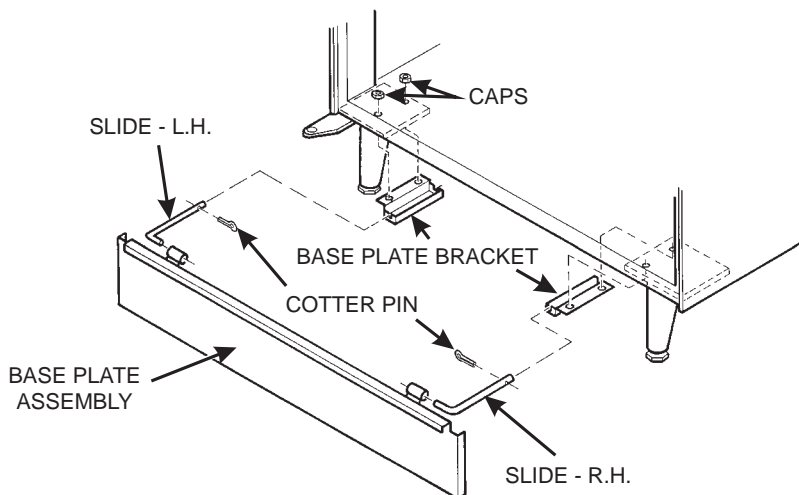

HOT DRINK SETUP/PROGRAMMING GUIDE

3. Install the Water Filter Cartridge:

IF YOUR MERCHANDISER HAS THE WATER FILTER OPTION, IT CANNOT BE OPERATED WITHOUT A PROPERLY INSTALLED WATER FILTER CARTRIDGE. If you do not have the water filter option, continue with "Fill the Tank".

CUNO BRAND ...

NOTE

Check the water filter installation record. There is a place to write the vend number on the cartridge. The cartridge is effective for a maximum of 64,000 7 oz. vends, 56,000 8 oz. vends, 50,000 9 oz. vends, or 37,000 12 oz. vends. Local conditions may require more frequent replacement.

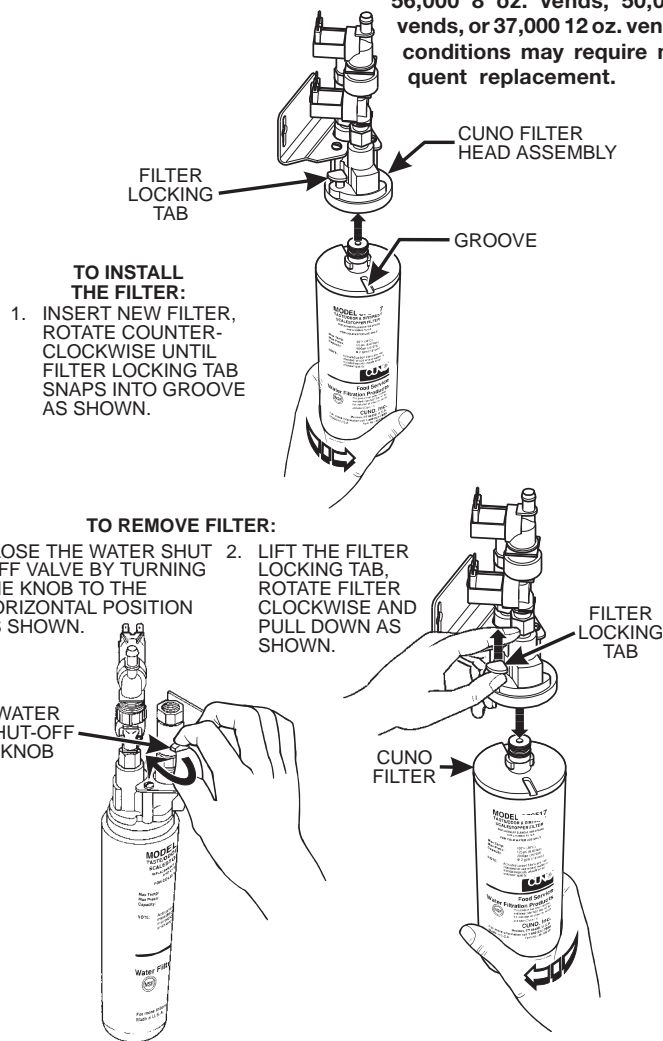

HOT DRINK SETUP/PROGRAMMING GUIDE

EVERPURE BRAND ...

NOTE

Check the water filter installation record. There is a place to write the vend number on the cartridge. The cartridge is effective for a maximum of 26,000 7 oz. vends, 22,000 8 oz. vends, 20,000 9 oz. vends, or 15,000 12 oz. vends. Local conditions may require more frequent replacement.

National Vendors recommends that you do the following procedure the **first time** you fill the tank in your EuroDrink merchandiser:

- Remove the small inner "O" ring from the filter cartridge.
- Install the filter cartridge.
- Turn on the water at its source, and perform the tank filling procedure.
- Turn off the water at its source, remove the filter cartridge, and replace the "O" ring.
- Install the filter cartridge.

TO INSTALL FILTER:

1. ALIGN RAISED RIB ON FILTER CARTRIDGE WITH MATING SLOT IN HEAD ASSEMBLY.
2. FIRMLY INSERT FILTER CARTRIDGE INTO HEAD ASSEMBLY AND ROTATE COUNTER-CLOCKWISE 1/4 TURN TO THE STOP.
3. OPEN THE WATER SHUT-OFF VALVE BY PUSHING THE HANDLE TO THE HORIZONTAL POSITION AS SHOWN BELOW.

TO REMOVE FILTER:

1. CLOSE THE WATER SHUT-OFF VALVE BY LIFTING THE HANDLE TO THE VERTICAL POSITION AS SHOWN BELOW.
2. ROTATE THE FILTER CLOCKWISE AND PULL DOWN AS SHOWN.

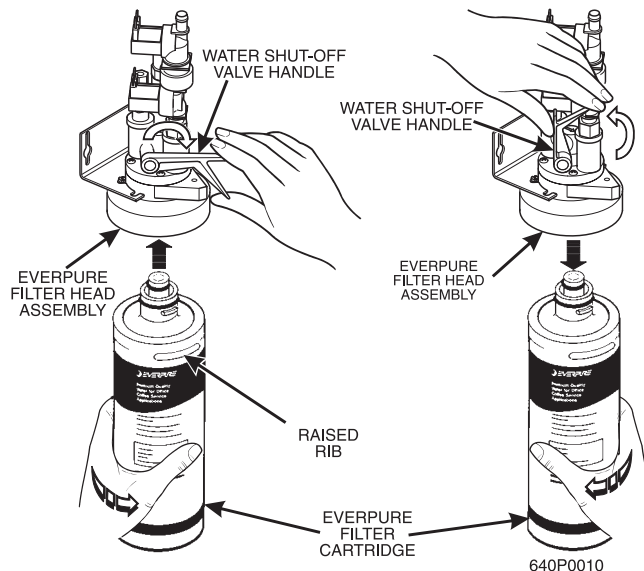

HOT DRINK SETUP/PROGRAMMING GUIDE

HYDROLIFE BRAND

INSTALLATION:

1. Place the filter inside the canister. Be sure the o-ring is seated in the canister just below the threads.
2. Screw the canister and filter assembly onto the filter head until it comes to a stop.
3. Open the water valve on the inlet line by rotating the handle to the vertical position as shown.

REMOVAL

1. Close the valve on the inlet line by rotating the handle into the horizontal position as shown.
2. Relieve water pressure by performing two or three water throws (see the programming section).
3. Unscrew the filter and canister assembly from the filter head. Remove the filter from the canister.

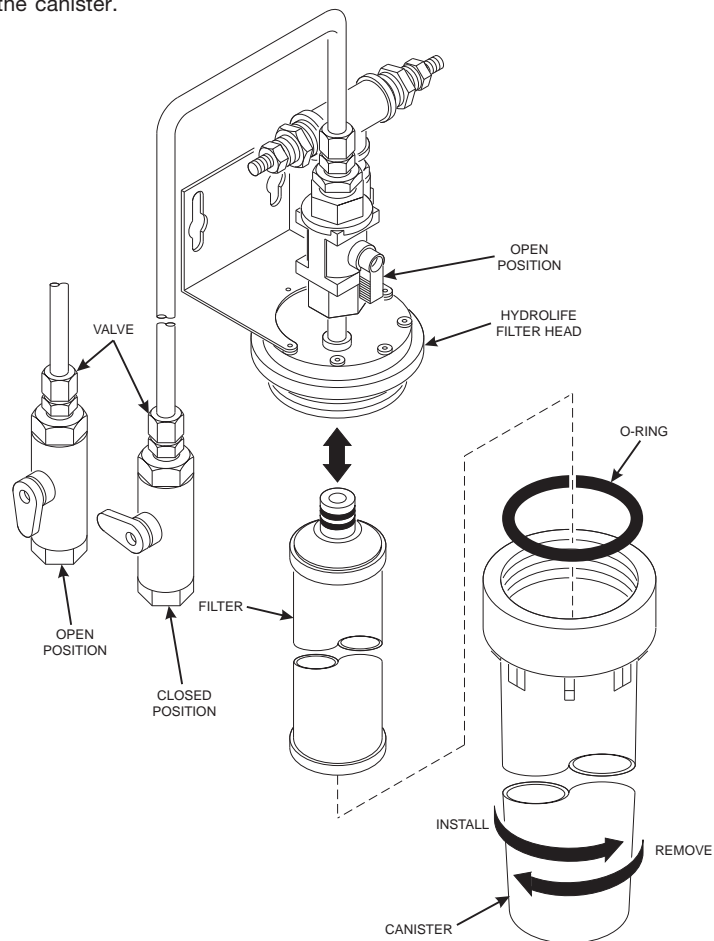

HOT DRINK SETUP/PROGRAMMING GUIDE

4. Load the Optional Filter Paper:

- Be sure the main power switch is in the *OFF* position.
- Remove the cup station and grounds bucket.
- Remove the paper holder cover by turning the fastener a quarter turn to the left.
- Insert a roll of paper into the paper holder. Route the free end of the paper to the brewer as shown.
- Replace the cover on the paper holder. Secure it by turning the fastener a quarter turn to the right.
- Feed paper over swing arm assembly and underneath pinion gear shaft.

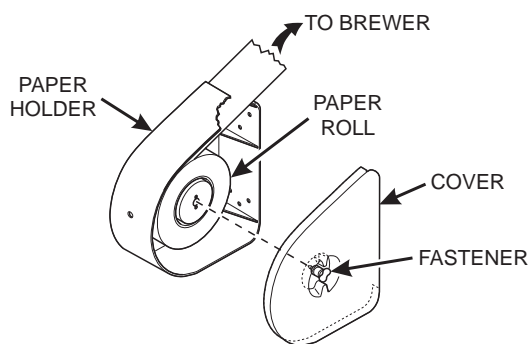

- Feed paper through the paper guides.
- Raise the basket housing assembly and feed paper over the lip of the paper mechanism housing.

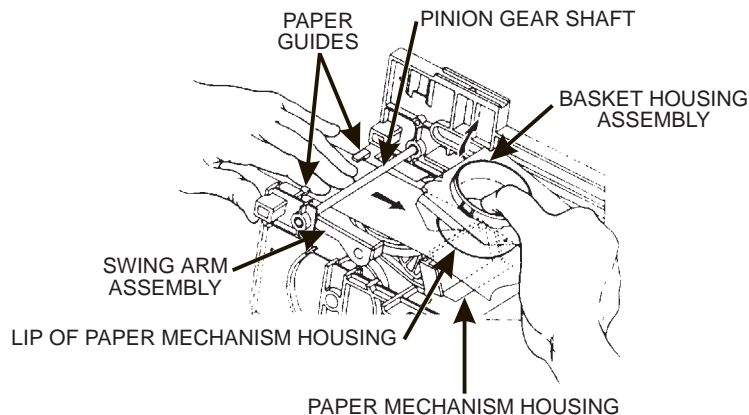

NOTE

It may be necessary to reach underneath the brewer between the paper mechanism housing and swing arm assembly to push paper over the lip of the paper mechanism housing.

(CONTINUED)

HOT DRINK SETUP/PROGRAMMING GUIDE

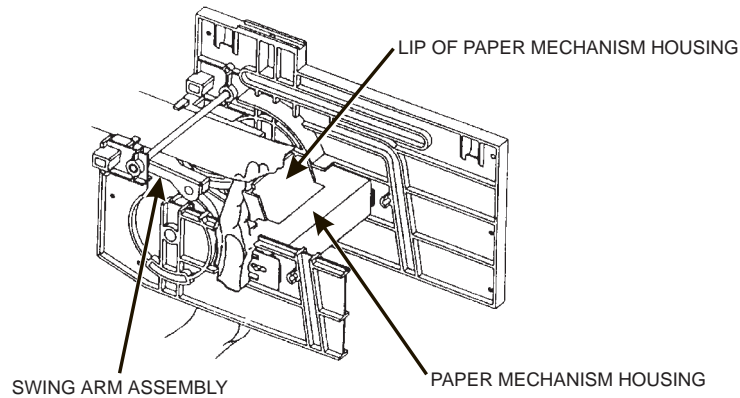

- i. Reach underneath the brewer between the paper mechanism housing and basket housing assembly and push paper into the top of the paper mechanism housing between paper rollers.

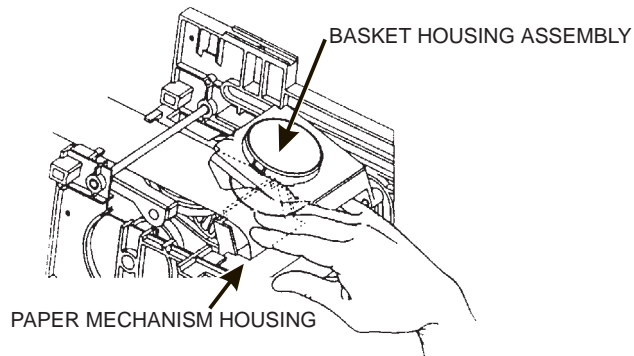

- j. Reach underneath the brewer and pull paper roller to the right.
- k. Pull paper down between the paper rollers.
- l. Release the paper roller.
- m. Place the main power switch in the *ON* position.
- n. Test the brewer to be sure the paper feeds properly:

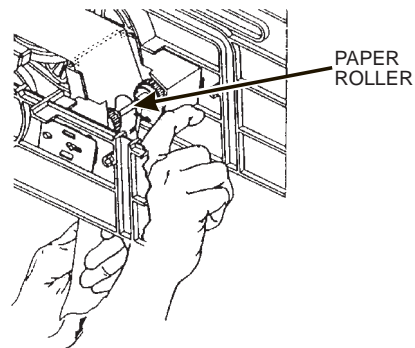

HOT DRINK SETUP/PROGRAMMING GUIDE

1. On the maintenance keypad, press , then press  until the display shows **BREW TEST**.
2. Press  to test each brewer position:

WARNING

Keep away from the brewer mechanism while it is operating. Coming into contact with moving parts could injure you.

BREW 'R BREW The brewer is in the BREW position.

BREW 'R FLIP The brewer is in the FLIP position.

BREW 'R HOME The brewer is in the HOME position.

3. Make sure the filter paper feeds properly without jamming.
4. Replace the cup station and grounds bucket.

5. Install the Optional Coin Box Lock

- a. Install the lock cylinder, washer, and nut in the order shown.
- b. Tighten the nut.
- c. Install the lock bar as shown, and secure with the screw.

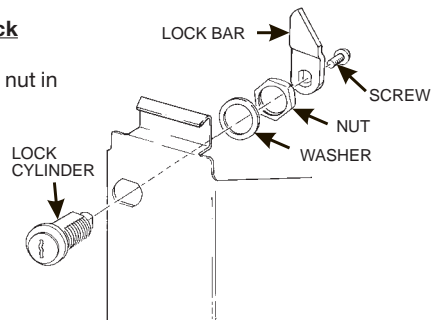

HOT DRINK SETUP/PROGRAMMING GUIDE

6. Set Up and Load the Coin Mechanism

Standard Coin Mechanism

Setting the Quarter Switch. If your coin mechanism is not a MARS TRC 6000, skip this procedure and begin **LOADING THE COIN MECHANISM**.

- a. Flip down the front of the coin mechanism as shown, and set the quarter switch.

Load the Coin Mechanism.

- a. Open the cabinet door and the monetary door.
- b. Insert coins into their respective tubes until each tube has been filled.
- c. Inspect the tubes for shingled coins and correct if necessary.

MDB Coin Mechanism

Install the coin mechanism as follows:

WARNING

Make sure the main power switch is turned OFF before you work on the merchandiser. Failure to do so could result in death or injury.

- a. Turn OFF the main power switch. Refer to the instructions provided with the coin mechanism and remove the coin validator assembly.
- b. Loosen the coin mechanism mounting screws on the merchandiser so they stand off about 1/8" (0.3 cm).
- c. Position the coin mechanism so the three keyed holes fit over the mounting screws. Pull down on the coin mechanism to seat the screws in the keyways.
- d. Tighten the mounting screws and reinstall the coin validator assembly.

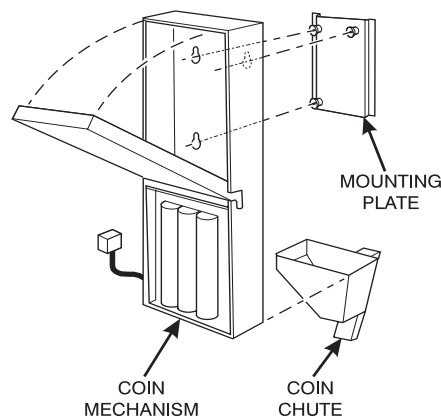

HOT DRINK SETUP/PROGRAMMING GUIDE

- e. The following figure shows a coin mechanism, bill validator, and card reader connected to one another via an MDB. Some monetary configurations may not include all of these devices. Connect your coin mechanism as shown:

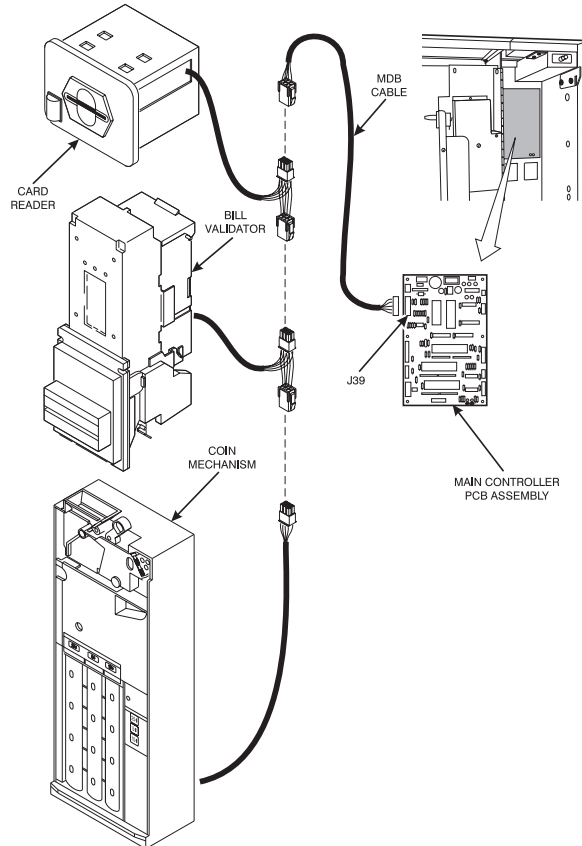

- f. Turn ON the main power switch. Select ***MDB MECH*** in the **SELECT COIN**

MECHANISM AND OPTIONS procedure on page 2-11. Press



until the

standby message is displayed, then press





. Insert enough coins through

the coin slot into the coin tubes to more than cover the empty sensor. Insert coins one at a time and ensure they lay flat in the tubes. The amount of coins you insert is internally recorded.

- g. Payout about 6 coins to ensure proper loading.
h. Finish inserting coins through the coin slot to fill all the tubes with coins.
i. Visually check the coin tubes to make sure coins are not shingled.

HOT DRINK SETUP/PROGRAMMING GUIDE

7. Fill the Tank:

- a. Make sure the main power switch is ON.
- b. Turn on the water at its source.
- c. On the maintenance keypad, press , then press  until the display shows **TANK.FILL**.
- d. Press . You should hear water running into the tank, and the display will show **FILLING**. The water will run until either the tank is full or 12 minutes go by, whichever happens first.

NOTE

The inlet water valve only stays open for 12 minutes at a time. This is a safety feature to prevent water from running into a leaky system and making a mess. It is possible for your tank to take longer than 12 minutes to fill if your location has low water pressure. To be on the safe side, check for leaks if the water runs a long time. If you find none, everything is normal; you just have low water pressure.

- e. When you hear the water stop running, repeat steps 3 and 4. Under normal circumstances, nothing will happen. If water starts running and the display shows **FILLING** again, your pressure is low and it is just taking a long time to fill the tank. Repeat this step if necessary to be sure your water tank is full.

8. Fill the Canisters:

Open the lid as shown, and carefully pour the appropriate product into the canister. Repeat for all canisters in the machine.

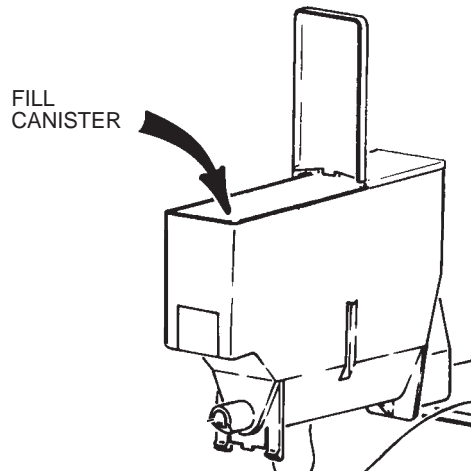

HOT DRINK SETUP/PROGRAMMING GUIDE

9. Load Cups:

CAUTION

Use only cups which have been designed for use in a hot beverage vending machine.

- a. Support the cup mechanism in the upright position.
- b. Push the latch forward to release the cup mechanism. Continue to support the cup mechanism while you lower it into the loading position.
- c. Remove the turret cover.

OBSERVE PROPER HYGIENE - DO NOT TOUCH THE CUPS!

- d. Open the bottom of the wrapper on a stack of cups.
- e. Insert the wrapped cups into the turret and pull the wrapper out.

DO NOT FILL CUPS ABOVE THE LEVEL MARKED ON THE OUTSIDE OF THE CUP TURRETS OR ABOVE THE "FILL LINE" LABEL INSIDE EACH TURRET, OR MOTOR JAMS WILL OCCUR. USE ONLY THE SAME SIZE AND BRAND OF HOT DRINK CUPS IN EACH TURRET; DO NOT INTERMIX!



- f. Replace the turret cover after the turrets have been loaded.
- g. Be sure the cup mechanism is locked into the upright position.

HOT DRINK SETUP/PROGRAMMING GUIDE

10. Cup Size(s):

a. Make sure the cup sizes you select agree with the cups you have actually loaded during setup.

b. Press , the display shows *X. Y. OZ.* *OXO* is the currently selected drink size for the cups in turret 2 (normally large cups), “Y” is the currently selected drink size for the cups in turret 1. (Normally regular cups).

c. Press  to change the #1 cup ring size; press  to change the #2 cup ring size.

d. Any changes made to the cup sizes must be “locked in”. There are two ways to do this:

1) If you are keeping some cup sizes the same, or putting the cups in different cup

rings, press and hold . The display momentarily shows *CLEARING*, two beeps sound, then shows *FINISHED*. This will reassign the old throw times to the new cup ring, if possible.

2) If you are loading all different size cups, or want to load all new default times, press

and hold . The display momentarily shows *CLEARING*, two beeps sound, then shows *FINISHED*. This will reload the factory default times you have established. (See the tables on the following pages for the factory default times).

e. CONTINUE

HOT DRINK SETUP/PROGRAMMING GUIDE

11. Test the Machine:

Your Hot Drink merchandiser is now ready to vend coffee, just as soon as the water in the tank reaches its operating temperature. Press , and a reading of the tank temperature is displayed. When the display shows 94° C (202° F), it is ready for vending.

a. Close the door, make a selection, and enjoy your cup of coffee!
b. You will now need to do the following before your machine is ready to start earning money:

- Set prices
- Set up the menu
- Establish time of day vending periods (if desired)
- Customize the drink recipes (if desired)
- Set up custom messages (if desired)

Refer to the Programming section for details on these and other procedures.

12. PosiVend™

PosiVend™ ensures that a cup is always available in the cup station before any money is collected or product delivered. The sensing system is a beam of infra-red light across the cup station which is broken by the cup when it falls into position.

The PosiVend™ software monitors the cup station sensor during the time the cup ring is cycled and for three seconds afterward. If a cup is not detected, the software will first determine if a second cup ring with the same size cups exists and will then try to drop a cup from the second ring. If the second ring also fails to drop a cup or is not usable, the software will repeat the attempt from the first cup ring to attempt to clear any jams in the cup delivery area. Each ring will be tried up to two times. If a cup is still not detected by the infrared sensor then several things happen:

- Any ring that failed twice in a row is placed temporarily out-of-service for a length of time that is determined by the user,
- The customer's credit is either restored for another vend attempt or is returned automatically,
- Three beeps are sounded and the message *SELECT ANOTHER SIZE* is flashed if another size cup ring is available, or the message *INSERT MUG* is flashed in the event that no other cups are available. The customer may always get his money back by pressing the coin return button.

INSERT MUG is the default message.

You may customize this message if desired.

HOT DRINK SETUP/PROGRAMMING GUIDE

Special rules exist to protect both the customer and the operator from loss. First and foremost, the customer is protected because no drink is spoiled nor money lost because a cup fails to fall to the cup station. The customer is given every chance to get his original choice of cup size by trying at least twice per ring to eject a cup. If two rings are available with the same cup size, the system will alternately try to vend a cup from each ring until the cup is delivered or both rings are placed out-of-service.

The operator is protected by the anti-jackpot program of the system. It is conceivable that a customer could prevent cups from reaching the sensing area of the cup station in order to steal the cups and then get his or her money back for the vend. Under the PosiVend™ Anti-Jackpot system, the operator can lose no more than two cups in a row per ring. Then that ring is temporarily placed out-of-service both to protect the customer and to discourage theft. The amount of time that the cup ring is out-of-service is programmable from 0 to 99 minutes. After the time has elapsed, the cup ring will return to service but the count of the two failures is kept. If the previous problem was theft, then the next vend attempt from that ring will be successful and the count of the two previous failures will be erased. If the problem is an actual system failure, then the third failure will permanently place that cup ring out of service until a service technician visits the machine.

Alternate cup vends and mug vends still work as before. If a cup ring is out of service due to PosiVend™ the alternate vend will only be from a selected large cup to a small cup at the small cup price. An induced PosiVend™ failure cannot cause an alternate vend from a selected small cup to a large cup at the small cup price. This protects the operator from customers trying to get large cup drinks at a small cup price. (PosiVend™ will not automatically switch to a different cup size in mid-vend because it cannot be ensured that correct change will be returned for the new price.)

PosiVend™ can be turned off if desired, (See **TURN POSIVEND™ ON OR OFF** page 49).

V. ADJUSTMENTS AND MINOR MAINTENANCE

1. Empty the Bill Stacker

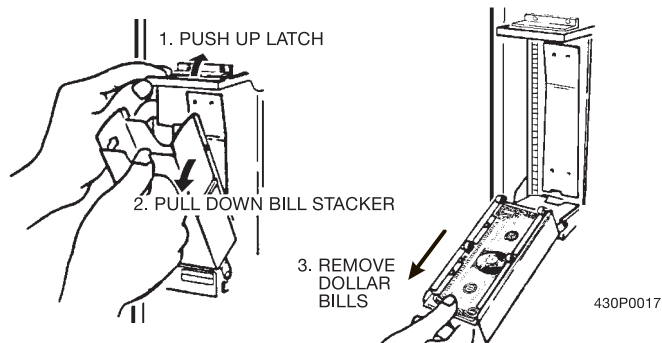

2. Adjust the Water Valves

Water valves do not usually require adjustment, but in some cases adequate water volume cannot be achieved by the throw time setting alone (see the programming section). **IF ABSOLUTELY NECESSARY**, adjust the valves in conjunction with setting the factory default timers during the Product Configuration programming mode.

1. Using a slotted screwdriver, turn the adjustment screw clockwise to decrease the water flow rate.
2. Turn the adjustment screw counterclockwise to increase the water flow rate.

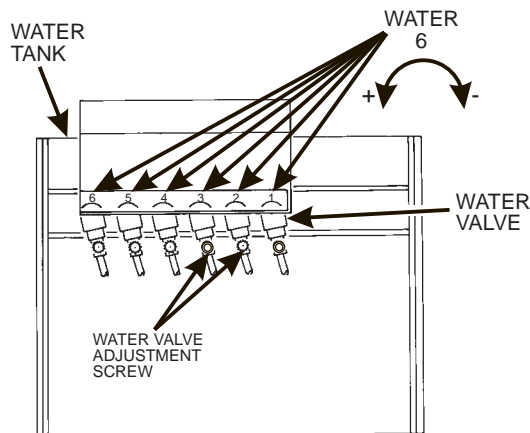

HOT DRINK SETUP/PROGRAMMING GUIDE

3. Adjust the Air Pressure.

This control determines the system pressure provided by the air compressor. Adjust as follows:

- With the compressor running, pinch the brewer inlet air tube.
- Adjust the pressure to read 10 - 12 psi on the gauge.

This will produce a pressure of 3 - 6 psi using regular coffee and 8¼ oz cups. No further air pressure adjustments should be necessary.

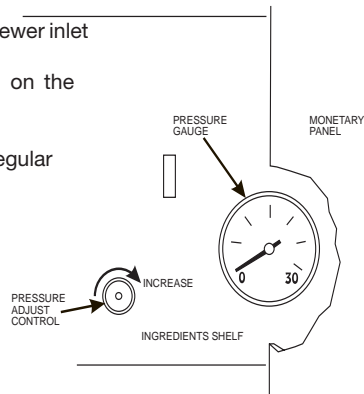

4. Install Canisters.

- Place the canister in position as shown.
- Engage the pins on the motor shaft with the slots in the canister coupler.
- Fit tabs on canister into the slots on the canister shelf.
- To ensure canister is correctly engaged with the rear mounting bracket, gently push down on the front edge of the canister lid.

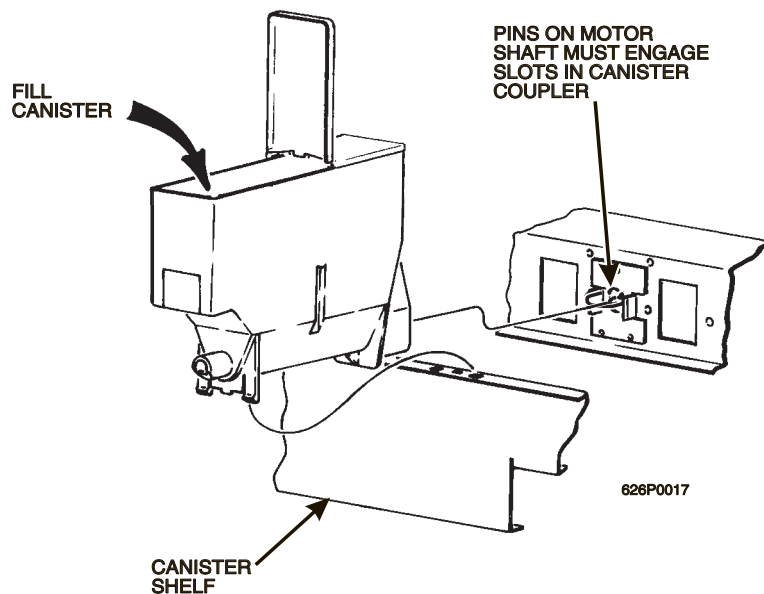

HOT DRINK SETUP/PROGRAMMING GUIDE

5. Adjust the Cup Mechanism.

1. Place seven cups in the cup ring.
2. Observe the clearance as shown in view B.
3. If necessary adjust by first loosening the adjustment arm screw (view A).
4. Move adjustment arm until correct clearance is achieved.
5. Hold adjustment arm in place and tighten adjustment arm screw.

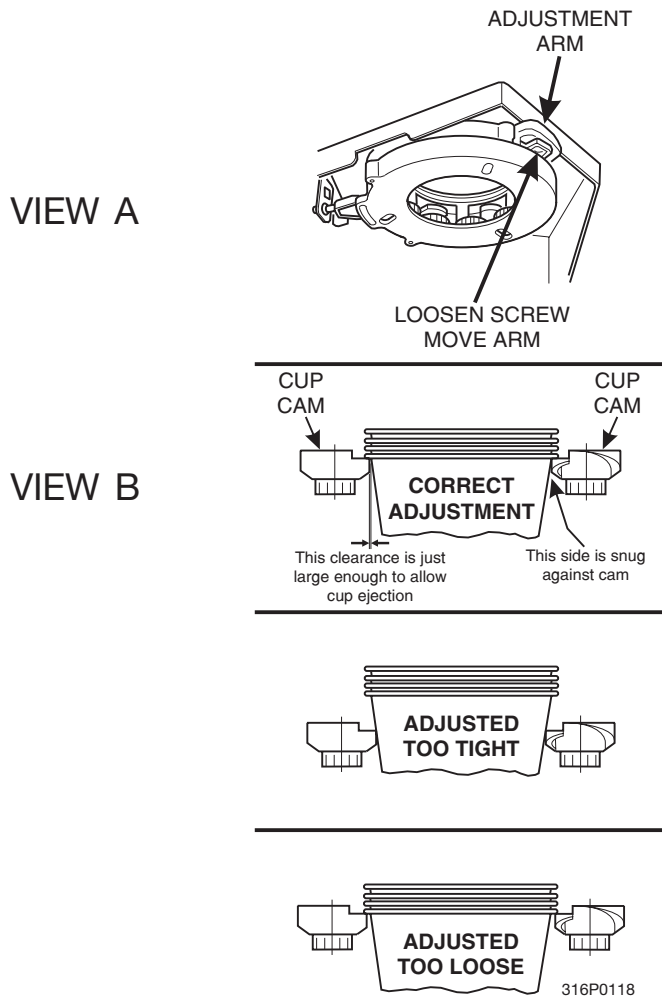

HOT DRINK SETUP/PROGRAMMING GUIDE

6. Set Up the Menu Assembly.

1. From the inside of the door, remove the two screws as indicated, and remove the end cap as shown.
2. Loosen the remaining 10 screws as indicated 1/2 turn. **Do not loosen the screws any more than necessary to avoid stripping out the menu frame.**
3. Remove the menu board. If it is still held too tightly, repeat step 2.
4. Set up the menu board as desired and reinstall it in the reverse order of disassembly.

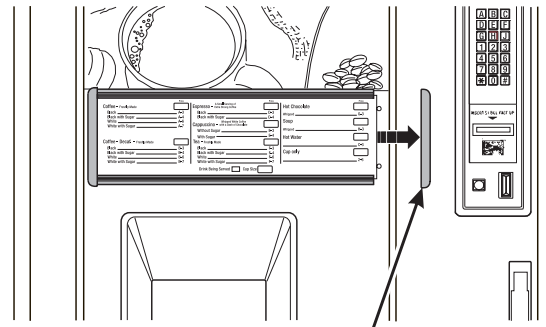

REMOVE THE MENU BOARD
END CAP AND SLIDE OUT THE
MENU BOARD.

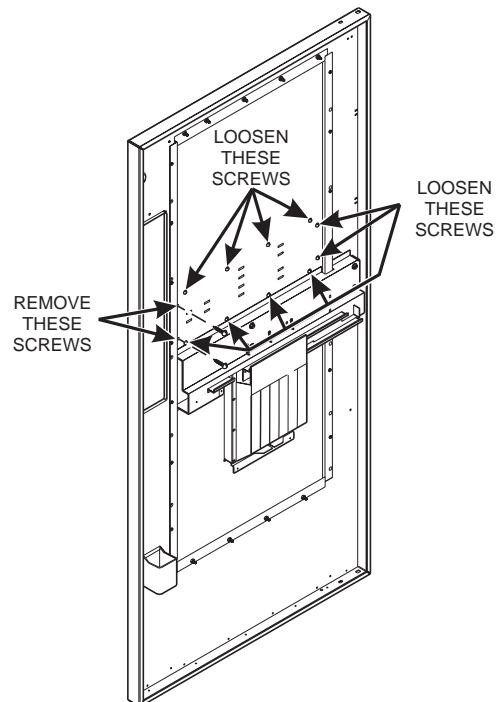

PROGRAMMING THE HOT DRINK

Getting Around

Getting around the Hot Drink software is pretty easy once you know the features that are available to you, and how to use them. The three main parts you will use are the SERVICE KEYPAD, the SELECTION SWITCH PANEL, and the DISPLAY.

The Service Keypad

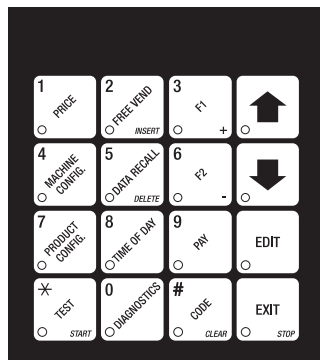

For most of your programming jobs, you will be using the service keypad conveniently located on the monetary panel. The service keypad has 16 keys. The three columns on the left are the **mode** keys. The right hand column contains the **movement** keys.

The Selection Switch Panel

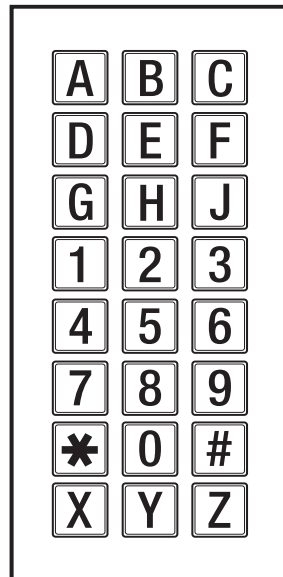

The selection switch panel is also located on the monetary panel. Unlike the service keypad, it is accessible when the cabinet door is closed. These are the keys the customer will use to make selections. You can also use these keys during programming procedures.

636P0044

The Displays

The 10-character display performs two functions, and is referred to in this book as "the display":

1. It shows the customer's selection and how much credit is in the machine, as well as the ready, service, and time of day messages.
2. It provides information and feedback to the service person during maintenance.



The Function Keys

The FUNCTION keys on the service keypad can be used for up to three things:

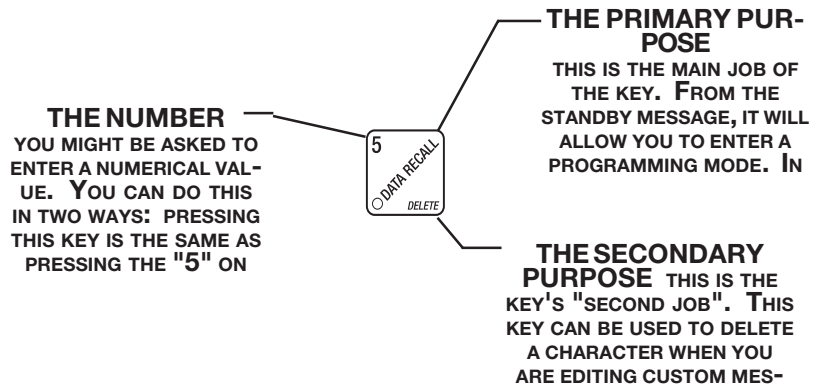

Other Keys

The MOVEMENT keys on the control panel let you move inside a mode, and back and forth between modes. To see how these keys let you move around, study the flow diagram on the next page.



The up and down arrow keys are your "legs", which let you move up and down the list of tasks. These keys are what let you continue from one step to the next in programming procedures.



This is your "activate" or "choose" key. It "opens a door" to additional information and lets you begin a programming task once you are inside of a mode. Sometimes, it is used as a toggle switch to show you your choices during a programming task.



This is your "end" key. Pressing it one or more times will move you back to the start of the mode, or all the way back to the standby message.



This key lets you start an action, such as a test.

HOT DRINK SETUP/PROGRAMMING GUIDE

III. CONTROL PANEL SWITCHES EXPLAINED



Press this button to put your machine into the Price Setting mode. You can see maximum and minimum machine prices, and change prices for entire machine or individual selection.



Press this button to set up how the Free Vend mode will operate.



Press this button to view the water tank temperature, software version number, machine and accessory configuration, and active selection status.



Press this button to:

- Select display language
- Select coin mechanism and options
- Select bill validator and options
- Select card reader and options
- Select monetary options
- Set winner feature



Press this button to:

- View total sales and vends by whole machine, selection, or drink size
- Clear resettable data
- View or set machine



Press this button to:

- Download data into your portable data collection device (PDCD), **OR**
- Set printer baud rate, depending upon which device you are using



Press this button to:

- Set machine type configuration
- Set which selections are active
- Set up blended selections
- Set up cup sizes

HOT DRINK SETUP/PROGRAMMING GUIDE



Press this button to:

- Set time of day
- Set day, month, year
- Set up time of day intervals for inhibit, freevend, and discount vending
- Select display messages
- Edit messages
- Set message scrolling speed



Press this button to pay one or more coins from the coin mechanism.



• Allows you to see any fault or condition that has placed the machine out of service



Press this button to:

- Perform TEST VENDS
- Test machine functions
- Test displays
- Fill the water tank



Press this button to:

- Enter the SUPERVISOR mode
- Change the SUPERVISOR access code
- Lock and unlock access to functions

Programming Procedures

SOME CONVENTIONS:

The pages that follow contain all the programming procedures for the Hot Drink. If you need to do a specific task, you can find it immediately by using the Programming Index. Most of the procedures have things in common, and here is a short guide to help you through these conventional presentations:

All programming procedures assume that you are starting with the standby message showing in the display. If not, just press  until you get there.

Each programming procedure is highlighted by a pointing hand:  so it will stand out.

To exit a mode (CONTINUE) at any time, press . Sometimes you may have to press the key more than once in order to exit all the way to the standby message.

Text that looks like this: *DISPLAY* represents what you will see in the display on the monetary panel.

Definitions and helpful information will appear in shadow boxes:

HELPFUL HINT

THE SUPERVISOR MODE

The supervisor is allowed to do things that a normal user cannot, like controlling access to certain modes. The supervisor can lock out any of the programming modes to anyone who does not have the right "key". Once a supervisor enters the proper code, he or she will be able to:

- Change the supervisor access code
- Lock out any or all of the service keypad modes
- Select whether price lines are used
- Set whether data is cleared after being downloaded into a portable data collection device
- Grant or deny access to data items during *DATA RECALL*
- Modify the machine configuration

 **GAIN ACCESS TO THE SUPERVISOR MODE**

1. Press . The display shows: *ENTER CODE*. You must enter the four-digit supervisor code within 6 seconds to gain access.



NOTE

A new machine has a factory-set supervisor code of *0000*.

When you have entered the right code, you will hear two beeps and see *UNLOCKED* in the display.

 **ENTER A NEW SUPERVISOR CODE**

1. Follow the steps in **GAIN ACCESS TO THE SUPERVISOR MODE**.

2. Press , then  until the display shows *SUPER XXXX*.

The X's represent the current supervisor code. Use the number keys to enter a new code.

IMPORTANT!

If you enter a new code, be sure to keep a written record of it. There is no other way to access the SUPERVISOR mode.

3. CONTINUE.

 **ENTER A FREEVEND CODE**

1. Follow the steps in **GAIN ACCESS TO THE SUPERVISOR MODE**.

2. Press  until the display shows *FREE XXXX*.



The X's represent the current freevend code. Use the number keys to enter a new code. If the code is anything other than "0000", it must be entered after the key lock is turned in order to enable free vends.

3. CONTINUE

HOT DRINK SETUP/PROGRAMMING GUIDE



LOCK OR UNLOCK MODE OR PAYOUT KEYS

1. Follow the steps in **GAIN ACCESS TO THE SUPERVISOR MODE**.
2. Press  until the display shows either *X. LOCKED* or *X. UNLOCKED*. "X" refers to the number or character shown on the mode or payout key in question (1 through 9, # and *). To see if a key is locked or unlocked, press that key.
3. Press  to change between locked and unlocked. When anyone other than the supervisor tries to enter a locked mode, the display shows *LOCKED*.

NOTE



The following mode keys cannot be locked out:









4. CONTINUE.



SET PRINTER OR DEX OPTIONS

1. Follow the steps in **GAIN ACCESS TO THE SUPERVISOR MODE**.
2. Press  until the display shows:
PRINTER means that data will be sent directly to a printer,
OR
DEX ONLY means that data remains in memory after it is downloaded into a portable data collection device (PDCD),
OR
DEX +CLR means that resettable data is cleared after it is downloaded into a PDCD.
3. Press  to change between the three choices.
4. CONTINUE.

 **LOCK OR UNLOCK DATA CLEARING ACCESS**



1. Follow the steps in **GAIN ACCESS TO THE SUPERVISOR MODE**.
2. Press  until the display shows either  *LOCKED* or  *UNLOCKED*. *LOCKED* means that non-supervisors cannot clear resettable machine sales and vend data from the  key.
3. Press  to switch between  *LOCKED* and  *UNLOCKED*.

NOTE

The supervisor can clear data regardless of this setting, provided the supervisor code was correctly entered first.

4. CONTINUE



 **SELECT DISPLAY LANGUAGE**

1. Press . The current LANGUAGE is shown in the display.
Press  to choose the desired language. Your choices are:
ENGLISH, DEUTSCH, FRANCAIS, ESPANOL, PORTUGUESE, SWEDISH, or NEDERLANDS.
2. CONTINUE

HOT DRINK SETUP/PROGRAMMING GUIDE





SELECT COIN MECHANISM AND OPTIONS

1. Press , then press  until the current COIN MECHANISM is shown in the display. Press  to choose the desired coin mechanism. Your choices are: *DUMB MECH.*, *MDB MECH.*, *EXEC MECH.*, or *NO MECH*

NOTE

If you selected *EXEC MECH* you can exit the function.

2. Press  until the display shows *CHANGE X.XX*.
Coins and bills which are less than or equal to this value will be returned without a purchase being made.
Examples:
CHANGE 0.00 - Forced vend; NO change returned without a purchase.
CHANGE .25 - Nickels, dimes, and quarters returned without purchase.
CHANGE 1.00 - \$1 bills and SBAs will be returned as change without purchase. Nickels, dimes, and quarters are also returned.
3. Press  until the display shows: *LOW.MSG X.XX*. The display will show *USE EXACT CHANGE* when the amount of available change in the coin mechanism falls below the value of "X.XX". Enter a value with the number keys. For example, if *LOW.MSG 1.00* is displayed, the *USE EXACT CHANGE* message is displayed when less than a dollar's worth of change is in the coin mechanism.
4. CONTINUE.

 **SELECT BILL VALIDATOR AND OPTIONS**

1. PRESS , THEN PRESS  UNTIL ONE OF THE FOLLOWING IS DISPLAYED:

- NO DBV** - No bills will be accepted or there is no bill validator installed (you can exit the function).
- SER.1.2.5.10.20** -The serial bill validator is selected and will accept \$1, \$2, \$5, \$10, and \$20 bills. Use BILL SELECTION METHOD below to change the bills which will be accepted.
- MDB.1.2.5.10.20** -A standard MDB bill validator is selected. It will accept \$1, \$2, \$5, \$10 and \$20 bills. Use BILL SELECTION METHOD below to change the bills which will be accepted.
- BILL SELECTION METHOD:**
The standard \$1, \$2, \$5, \$10 and \$20 bills are enabled by pressing the **1, 2, 5, 6, or 7** key(s), respectively, to display which bill(s) will be accepted.
- MDB. <❖>** - An MDB bill validator which accepts non-standard bills or tokens is connected and

operating. Press  to enter list of bills.

(See **INITIAL SETUP OF NONSTANDARD BILL VALIDATOR** on the following page.)

BILL LIST OPERATION:

Use  and  to scroll through the list of bills.

Use  to turn the bill acceptance ON or OFF.

Use  to move up to the top level screen.

HOT DRINK SETUP/PROGRAMMING GUIDE

1. **1.00 ON** -1. = Bill validator channel 1, each bill has its own channel
1.00 = Bill value
ON = \$1.00 bill will be accepted
 1. **1.00 OFF** -OFF = \$1.00 bill will not be accepted
- TKN** - Token bills (same as coupon bills)

INITIAL SETUP OF NONSTANDARD BILL VALIDATOR:

Connect the bill validator, select MDB in the bill validator selection screens. The standard "MDB.1.2.5.10.20" screen will appear first. Exit the bill validator setup by

pressing . Bill information is now collected from the validator. Re-enter the bill validator selection screen and the nonstandard screen "MDB.<*>" will appear.

PULSE DBV - The pulse bill validator will accept \$1 bills.

Press  to choose the desired option.

2. CONTINUE.





SELECT MONETARY OPTIONS

This function lets you:

- Set declining balance,
- Set currency acceptance on low change,
- Set overbuy options,
- Set last bill stacking options

DECLINING BALANCE: Once credit is established, multiple vends may occur until the coin return is pressed.

1. Press , then press  until one of the following is displayed:
DECLINE.ON - More than one vend is allowed, with a declining balance.

OR

DECLINE.OFF - A declining balance is not allowed.

Press  to display the desired choice.

2. Press  until one of the following is displayed:
ACC \$\$\$ X.XX - The last bill which meets or exceeds maximum price will be held in escrow.

OR

ACC.STK X.XX - The last bill which meets or exceeds maximum price and MDB coupon bills (token bills) will be immediately stacked.

Example: If setting is *ACC.STK 1.00* and maximum price is \$1.50. This setting will immediately stack the second \$1.00 bill inserted.

HOT DRINK SETUP/PROGRAMMING GUIDE

Press  to display the desired choice.

The value of "X.XX" has two purposes:

- a. The value of "X.XX" tells the machine how big a bill or coin to accept even though there is not enough change in the coin mech to cover all possible paybacks.
- For example, enter **1.00**. Therefore, the machine will take a dollar bill or coin even though there is less than \$1.00's worth of change. Entering **5.00** tells the machine to take a five even though there is less than \$5.00's worth of change, and so forth.

NOTE:

This could cause a customer to be shortchanged.

- Entering **0.00** means that bills or coins will only be accepted if there is enough change to cover them.
- b. The value of "X.XX" tells the machine how much the customer is allowed to overbuy a product. The customer will be shortchanged when an overbuy occurs.

Example:

For a value of \$0.25: if there is no change in the machine and the customer inserts a \$1.00 bill. The customer can purchase a product for \$0.75 even though the change cannot be paid back. The customer will be shortchanged. Normally a purchase will not be approved unless all change can be paid.

Entering 0.00 means that the vend will only be approved when the correct change can be returned (overbuy disabled).

(Continued)

HOT DRINK SETUP/PROGRAMMING GUIDE

- For example, enter **1.00**. Therefore, the machine will take a dollar bill or coin even though there is less than \$1.00's worth of change. Entering **5.00** tells the machine to take a five even though there is less than \$5.00's worth of change, and so forth.

NOTE:

This could cause a customer to be shortchanged.

- Entering **0.00** means that bills or coins will only be accepted if there is enough change to cover them.
b. The value of "XXX" tells the machine how much the customer is allowed to overbuy a product. The customer will be short-changed when an overbuy occurs.

Example:





For a value of \$0.25: if there is no change in the machine and the customer inserts a \$1.00 bill. The customer can purchase a product for \$0.75 even though the change cannot be paid back. The customer will be shortchanged. Normally a purchase will not be approved unless all change can be paid.

Entering 0.00 means that the vend will only be approved when the correct change can be returned (overbuy disabled).

3. CONTINUE



SELECT CARD READER AND OPTIONS

1. Press , then press  until the current card reader is shown in the display. Press  to choose the desired card reader. Your choices are: *NO CARD*, *DUMB CARD*, or *MDB CARD*.
 2. Press  until one of the following is displayed:
REVALUE.ON - Allows credit to be transferred onto the card
REVALUE.OFF - Credit cannot be transferred to the card
Press  to display the desired choice.
 3. CONTINUE
-

HOT DRINK SETUP/PROGRAMMING GUIDE



SET UP WINNER MODE

WINNER: At pre-selected intervals, a customer may receive a refund for a selection. You can select the intervals and qualifying selections.

1. Press , then press  until one of the following is displayed:

WINNER OFF Winner function is disabled.

OR

WIN XXX Winners are allowed at certain intervals, represented by "XXX".



Press  to display the desired choice.

If you selected **WINNER OFF**, you can CONTINUE. Otherwise, go to the next step.

2. The display shows **WIN XXX**. **XXX** represents the number of vends which must occur per each winner vend. For example, an interval number of 50 means that a winner can happen any one time during the next 50 vends. Using the number keys, enter an interval number between 10 and 9999.

3. Press . The display shows ***.-----**. The dashes in the display represent which selections are allowed winners. Press the appropriate letter key to enable a selection; press the key again to disable it. For example, pressing **A**, **C**, and **E** will cause the display to look like this: ***.A-C-E----**, meaning that all A, C, and E selections can have a winner.

ADVANCED OPTIONS:

- Press  to enable all selections; press  to disable all selections.
- Press **0** or **1** to enable winners by cup size.

AN EXAMPLE . . .

You want to enable winners on all selections except E and F. Do the following:



HOT DRINK SETUP/PROGRAMMING GUIDE

- a. Press . The letters *A* through *J* appear in the display instead of the dashes.
- b. Press **E** and **F**. The letters *E* and *F* in the display are replaced by dashes.

4. CONTINUE.





SET UP THE MUG DISCOUNT

1. Press , then press  until the display shows *MUG DSC XX*. *XX* represents the value of the discount customers will receive for using their own mugs or cups. Enter the amount with the number keys. Enter **0** for no discount.

2. CONTINUE.



SET THE PRINTER BAUD RATE

1. Press . The display will show one of the following rates:
BAUD 1200, BAUD 2400, BAUD 4800, or BAUD 9600.
2. Press  until the desired baud rate is displayed.

NOTE:

This baud rate must match that of your printer, or it will not function properly.

3. CONTINUE.

HOT DRINK SETUP/PROGRAMMING GUIDE

LOCK OR UNLOCK SELECTIONS

1. Press . The display shows *LK. - - - - -*. This shows a list of selections which are locked. Here, all selections are unlocked because they show up as dashes (-). Press the appropriate selection letter to switch from locked to unlocked and back again. For example, to lock out the "A" and "C" selections, press those letter keys on the selection switch panel. For this example, the display will show *LK. A [] C - - - -*.



Selections can be LOCKED OUT (made unavailable for vending). You may want to do this if there is a problem with that selection, such as no product in the canister.

You can lock all selections at once by pressing .



Unlock them all at once by pressing .

2. CONTINUE.

DISABLE SELECTIONS IN THE MERCHANDISER

1. Press , then press until the display shows something like this:
LK. ABCDEFGH. This display means that all regular size selections (A - H) are not available for vending. An available selection has its letter replaced by a blank space. Press  to display the second screen for X, Y, and Z selections.
2. Press the appropriate letter to toggle the display on or off.



NOTE



Press  to lock all selections; press  to unlock all selections.



**ASSIGN CUP SIZES TO SELECTIONS
(SUPERVISOR MODE ONLY)**

You can load up to two different sizes of cups in your machine (see set up cup sizes, page). You may not always want a certain selection to use all of the cup sizes in your machine. For example, espresso is normally served in regular cups, so you probably will not want it to be available in large or jumbo cups.

1. Press , then press , until the display shows something like this: *0 ABCDEFGH*. This display means that the smaller of the two cup sizes (0) is available for selections (A-H).

2. Press  to display all selections; press  to clear all selections.



3. Press  to display remaining selections (*0 4Z2- - -*). In this display, the “Y and Z” represents the blended product, and the “2” represents the cup only selection.

NOTE:

If you have only one cup size in your machine, you will not see the next display.

4. Press . The display shows something like this:
1 ABCDEFGH. This display means that the larger of the two cup sizes (*1*) is available for all selections (A - H).

5. Press the appropriate letter to toggle the display on or off. A selection that doesn't vend the displayed size cup has its letter replaced by a dash (-).

6. Press  to display all selections; press  to clear all selections.

7. Press  to display remaining selections (*1 4Z2- - -*).

In this display, the “*4* and *Z*” represents the blended product, and the “*2*” represents the cup only selection. (Continued)

HOT DRINK SETUP/PROGRAMMING GUIDE

To vend a cup only, press 1, 2, 3 (large size) or 2, 3 (regular size).

8. Continue

SET UP A HOT DRINK

Be sure that the cup sizes you set in (setup cup sizes page,), agree with the cup sizes actually in your machine. All procedures for setting up the hot drinks are similar, so this example will demonstrate how to set up the A selection, regular size fresh brew coffee.

1. Press , then press  until the display shows *SETUP -**.

The star (*) represents the selection (A, B, etc.). The dash (-) represents the size of the selection.

2. Press **A**. (If you were setting up the A selection for the large size drink, you would press **1** first, then **A**.) The display shows *WAT. A 12.00*. This means that the currently set water throw time for the A selection is 12.00 seconds. Enter a new time if desired.

3. Press . The display shows *DRY. A .60*. This means that the currently set dry product throw time for the A selection is .60 seconds. Enter a new time if desired.

4. Pressing  after each display will cause the following screens to appear:

DRY. A+ View and change the settings for an extra strong drink
SUG. A View and change the settings for the sugar throw time
SUG. A+ View and change the settings for extra sugar throw time
LIT. A View and change the settings for the lightener throw time
LIT. A+ View and change the settings for extra lightener throw time
SUB. A View and change the settings for the sugar sub throw time
SUB. A+ View and change the settings for extra sugar sub throw time
STP. A View and change the steep time
STP. A+ View and change the steep time for an extra strong drink
AIR. A View and change the air compressor/pump running time
DLY. A View and change the amount of time after the vend to open the auto vend door

 **WHIPPER OPTIONS**

WHP. A XXX Press to view and change the whipper settings as follows:

- ON0** The last 3 seconds of the drink is always whipped
- ON+** The whole drink is always whipped
- OFF** The drink is never whipped
- OPT** See below

- If **J+** is selected (See **SET THE MACHINE TYPE CONFIGURATION CODE, PAGE 54**):

- OPT0** The last 3 seconds of the drink is whipped only when the **J** key is pressed
- OPT+** The whole drink is whipped only when the **J** key is pressed

- If **J-** is selected (See **SET THE MACHINE TYPE CONFIGURATION CODE, PAGE 54**):

- OPT0** The last 3 seconds of the drink is whipped unless the **J** key is pressed
- OPT+** The whole drink is whipped unless the **J** key is pressed

DIFFERENCES:

Some selections will not show all of these items. The **E** selection will have some additional selections:

WA.2 E View and set the water throw time for the cappuccino second product (chocolate)

DR.2 E View and set the chocolate throw time for cappuccino

PCT. E To automatically compute new times for cappuccino, enter a

percentage, then press . This percentage

represents the amount of chocolate product in cappuccino, versus that in a normal chocolate drink. This time and the normal coffee settings will compute the new cappuccino time.

This is a handy way to move from one selection to another without going to the **SETUP** screen first.

If you try to set up a selection that is not configured, the **SETUP** screen will remain in the display.

HOT DRINK SETUP/PROGRAMMING GUIDE

OPTIONS:

a. At any of the preceding displays, you can press  to test throw that item.



b. At any of the preceding displays, you can press * or # (on the selection switch panel) to step through a list of that item's throw times for other selections where that item is active. For example, pressing # at the *WAT. A* display will show the throw time for *WAT. B*. This is a handy way to move from one selection to another without going to the *SETUP* screen first.

NOTE

If you try to set up a selection that is not configured, the *SETUP* screen will remain in the display.

5. Continue.

VIEW OR SET THE HOT WATER TANK TEMPERATURE

1. Press  then  until the display shows *SET 202 °F* .

In this example, 202° is the water tank temperature setpoint in degrees Fahrenheit. If a decimal point appears next to the "F", the heater is on.

2. If desired, enter a new setpoint in the accepted range of 149° - 205° F (65° - 96° C).

NOTE

The lower limit for vending is 20° below setpoint, up to a maximum of 180° F (82° C).

3. To change display units (replace the "F" with a "C" for Celsius), press



4. Continue.

HOT DRINK SETUP/PROGRAMMING GUIDE

SET UP LOW TEMPERATURE DISPENSING

1. Press  then press  until the screen displays either

LTDIS OFF. This causes the machine to operate the same as the previous Hot Drink Center. For example, with a setpoint temperature of 202° F the machine will inhibit vending when the water tank temperature reaches 182° F.

-or-

LTDIS ON. Allows vending to a water tank temperature of 140° F.

2. Press  to change between *ON* and *OFF*.
3. Continue.

SET UP LOW POWER SETTINGS

Low power settings allow for the water tank to be set to a lower temperature at up to 4 different dates and times. For example, you want to lower the tank temperature to 160° F overnight on Mondays through Fridays. The machine tank temperature setpoint will be changed to 160° F at 6:00 pm and maintained at that temperature until 5:00 am on the following morning when the setpoint is returned to 202° F. Please keep in mind that at 5:00, the machine will just begin to increase to the 202° F setpoint temperature. It is up to you to determine how long that will take and to allow enough time for the tank to be at its proper temperature when the machine will be used. Typically, one hour is adequate to return to the normal operating temperature.

NOTE:

The machine *OUT OF SERVICE* condition during the low power interval will be determined by how you have set the *LTDIS* configuration.

(Continued)

HOT DRINK SETUP/PROGRAMMING GUIDE

1. Press  then press  until the screen displays
LOW.PWR.

Press the number of the time interval you want to edit, or  to edit time interval 1 (we will use interval 1 for this example).

2. The display shows *LOW.PW ON or LOW.PW OFF.* This display tells you whether your time interval (represented by 1) is on or off. Press

 to change the condition of the time interval.

3. If you turn an interval ON, it must be edited. You can edit a time interval now, then turn it OFF until another time.

4. Press . The display shows *1.STRT X.XX.* *X.XX* is the currently set start time. Enter a new start time (24-hour format) for this interval. To enter the time for 6:00 pm, enter 1800.

5. Press . The display shows *1.STOP X.XX.* *X.XX* is the currently set stop time. Enter a new stop time (24-hour format) for this interval. To enter the time for 5:00 am, enter 0500.

- Press . The display shows *1.@ - - - - -*. The dashes represent the days that this time interval is active. Pressing number keys 1 through 7 switches the days on/off. For example, press “2”, “3”, “4”, “5”, and “6”. The display now shows *1.@ - M T W T F -*.

This interval is active on Monday through Friday.



SET THE RATIO OF CHOCOLATE IN CAPPUCCINO

1. Press , then press  until the display shows either:

RATIO XX "XX" is the percentage of chocolate contained in a cappuccino drink or **RATIO OFF** No ratio is selected.

2. Press  to switch between these two displays. To change

the value of **RATIO XX**, enter the numbers directly. This is a quick way to set up your cappuccino drinks. See table D2 to see the actual throw times/amounts for certain preset ratios. You can set a ratio close to your taste, turn ratio OFF, then alter the product throw.

NOTE

Leaving this step with **RATIO OFF** displayed does not alter any previous settings for **E** and **I** selections. Leaving this step with a ratio set will alter those settings. The ratio automatically selects the times for water and dry product throw. The **E** and **I** selections no longer appear in the displays for those steps. If you desire greater control over your cappuccino drinks, leave ratio OFF.

3. CONTINUE.



SET THE BREWER RINSE TIME INTERVAL

1. Press , then press  until the display shows **SAN.TIME**

X.X. "X.X" represents the time of day (in hours and tenths of hours) the machine rinses the brewer. For example, **SAN.TIME 4.5** means that brewer rinse takes place at 4:30 am. Use the number keys to enter a new time, if desired. Range: 0.0 - 23.9 in .1 hour (6 minutes) increments.

2. Press . The display shows **SAN.HRS X.X**. "X.X" repre-



sents how soon the machine rinses the brewer after the last brewed selection. For example, **SAN.HRS 2.5** means brewer rinse takes place 2.5 hours after the last vend. Use the number keys to enter a new time, if desired. Range: 2.0 - 12.5 hours, in .1 hour (6 minutes) increments.

3. CONTINUE.

HOT DRINK SETUP/PROGRAMMING GUIDE

SET THE BOWL RINSE TIME

Mixing bowl(s) can be automatically rinsed by one of two methods: You can specify a set time of day when the bowl is rinsed, or you can specify that rinsing takes place a set time after the last selection is vended.1.

Press  then  until the display shows one of the following:

RIN.HRS 2.5 - This is how soon the machine rinses the bowls after a vend. In this example, bowl rinse takes place 2.5 hours after the last vend. Range: 2.0 - 12.5 hours, in .1 hour (6 minute) increments.

-or-

RIN.TIME 4.5 - The time of day (in hours and tenths of hours) the machine rinses the bowls. In this example, bowl rinse takes place at 4:30 am. Range: 0.0 - 23.9 in .1 hour (6 minute) increments.

NOTE:

If 24 hours passes without a vend, no rinsing will take place. This eliminates unnecessary rinsing over a weekend or holiday.

-or-

RINSE OFF - No bowl rinse takes place.

2. Press  to switch between these options, and the number keys to enter new values.
3. Continue.

TURN POSIVEND™ ON OR OFF

1. Press  then  until the display shows one of the following:

POSIV OFF: None of the PosiVend™ functions are available. Use this if the PosiVend™ system is not installed, or there is some reason you do not want to use it (for example in a high cup theft situation).

POSIV ON. The PosiVend™ system is operative. All of the PosiVend™ functions are available.

2. Press  to switch between the two choices.
3. Continue.

 **OPTIONAL OR MANDATORY POSIVEND™**



1. Press  then until the display shows one of the following:

OPTION POSIV: The machine reverts to home switch operation of the ring motors if the PosiVend™ system cannot operate normally because of an obstruction in the cup station or for any other reason.

MUST POSIV: The vending machine is operational only if the PosiVend™ system is determined to be working. Otherwise, the machine will go temporarily out of service until the blockage or other error is corrected.

2. Press  to switch between the two choices.
3. Continue.

 **SET UP THE POSIVEND™ ANTI-JACKPOT TIMER**

1. Press  then  until the display shows *AJP.TMR XXM*.



XX represents how many minutes PosiVend™ will be disabled for either cup ring. The same value applies to the two timers (one on each ring).

2. Enter a number using either keypad.



If any cup ring motor fails to deliver a cup on two consecutive attempts, the cup ring goes out of service. After the time set in step 2 has elapsed, the cup ring goes back in service and is given one more chance to deliver a cup. If cup delivery is again unsuccessful, the ring goes out of service until the machine is serviced. A successful delivery on any cup ring will reset the failed attempts for that particular cup ring. If both cup rings perform three consecutive failed attempts (and the PosiVend™ sensor is determined to be working), the entire machine goes in the “mug only” mode until the machine is serviced. If either cup ring performs three consecutive failed attempts with the other cup ring in anti-jackpot timer mode, the entire machine will be in “mug only” mode (assuming PosiVend is working) until the preset time elapses (one more attempt will be made to deliver a cup) or the machine is serviced by a route operator.

HOT DRINK SETUP/PROGRAMMING GUIDE



VIEW NUMBER OF MUG VENDS (NOT SHOWN IF ZERO)

1. Press , then press  until the display shows *MUG*
X. “X” is the number of mug vends.
2. If desired, view this data by tray and individual selection.
3. Continue.

VIEW MACHINE ID NUMBER

1. Press , then press  or  until the display shows
I.D. XXXXXX. The X’s represent the 6-digit machine ID number.
2. You can edit the machine ID number if the supervisor access code has been previously entered (See GAIN ACCESS TO THE SUPERVISOR MODE).
3. Continue.

VIEW CUP RING CYCLES RELATED TO POSIVEND™ (NOT SHOWN IF ZERO)

1. Press , then press  until the display shows *PV.TOT*
XX. *XX* represents the number of vends during which more than one ring cycle was required to successfully dispense a cup.
2. Press  to clear the count.
3. Continue.

 **VIEW TIMES NO CUP WAS DETECTED AFTER A CUP RING CYCLED
(NOT SHOWN IF ZERO)**

1. Press , then press  until the display shows *PV.FL 1*

XX. *XX* represents the number of times a cup was not detected after ring 1 cycled. Check the cup ring adjustment (see the **Operator's Guide**), or the cup stack for damage if the count is excessive.

2. Press  to clear the count.

3. Press  until the display shows *PV.FL 2 XX*. *XX* represents the number of times a cup was not detected after ring 2 cycled. Check the cup ring adjustment (see the **Operator's Guide**), or the cup stack for damage if the count is excessive.

4. Continue.

 **VIEW HOME SWITCH USAGE RELATED TO POSIVEND™
(NOT SHOWN IF ZERO)**

1. Press , then press  until the display shows *W.D.PV XX*.

XX represents the number of times home switches were used due to *OPTION POSI.V* selected but not working.

2. Continue.

HOT DRINK SETUP/PROGRAMMING GUIDE



VIEW POSIVEND™ LAST RECORDED CALIBRATION VALUE

1. Press  PosiVend™ until the display shows *CALLST XXX*.

XXX can be any number from 0 to 255, and represents the most recent value read from the sensor. The lower the number the greater the sensor blockage. A number of 255 means that there is a fatal problem with the PosiVend™ interface board. Ensure the PosiVend™ interface PCB is properly connected to the main controller PCB.

2. Continue.



VIEW POSIVEND™ AVERAGE CALIBRATION VALUE



1. Press , then press  until the display shows

CAL.AVE XXX. *XXX* represents the average sensor calibration value (should be between 50 and 255 for proper sensor operation - i.e. 51 through 254). Although this number could go as low as 20, the PosiVend™ system will be inoperative in this condition.

2. Continue.



CLEAR TANK ERRORS AND FILL THE TANK

1. Press , then press  until the display shows *TANK FILL*.

2. Press . This clears any tank error and starts filling the tank, if necessary. If it is taking a long time to fill the tank AND THERE ARE NO LEAKS, you may see *TANK ERR* in the diagnostic

list again. Just press  again after making sure there are no other problems, such as a restriction in the water inlet line or a clogged water filter.

3. Continue.



**SET THE MACHINE TYPE CONFIGURATION CODE
(Supervisor Mode Only)**

1. Press , then press  until the display shows *MACH.TYPE (X)*.

Press  to enter *MACH.TYPE (3)*.

2. Press . The display shows *CONF WXYZ* "WXYZ" is the machine configuration code. W represents the machine type, X is the soup and sugar substitute configuration, Y is the brewer configuration, and Z is canister mapping. The following tables give the possible values for each of the four numbers. Enter the appropriate configuration code for your machine.

3. CONTINUE.

Machine Type Configuration

Enter for (W)	Definition
1	Reserved for alternate use.

Soup and Sugar Substitute Configuration

Enter for (X)	Definition
1	Canister 5 is not used.
2	Canister 5 contains sugar substitute.
3	Canister 5 contains soup.

HOT DRINK SETUP/PROGRAMMING GUIDE

SINGLE BREW	A machine with only one brewed selection (the second selection is freeze dried). Uses a single barrel brewer.
DUAL BREW	A machine with two brewed selections. Uses a single barrel brewer.

Brewer Configuration

Enter for (Y)	Definition
1	Single Brew - Coffee or leaf tea (Model 670)
2	Dual Brew - Coffee and decaf coffee (Model 670)
3	Freeze Dry only - no brewer (Model 678)

Canister Mapping (See Figure Below)



Enter for (Z)	Menu Selection Letters for Canister Numbers		
	3	2	1
1	F	B	A
2	F	A	B
3	B	F	A

Index: A = Coffee B= Decaf F = Tea

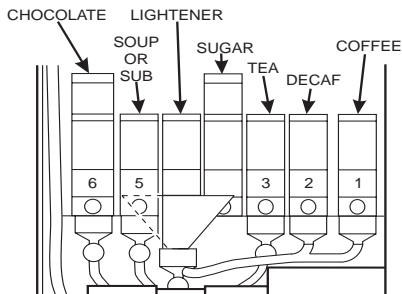

HOT DRINK SETUP/PROGRAMMING GUIDE



SET UP THE CUP ONLY OPTION (Supervisor mode only)

1. Press , then press  until the display shows **CUPVND X/Y**. This allows you to set whether a customer can buy a cup only (no drink), and which types of cups will be vended. "X/Y" represents the cup only vend configuration.
2. Press  to switch between the following configurations:
 - /- = Cup only not allowed
 - 0/- = Regular cup only vended
 - /1 = Large cup only vended
 - 0/1 = Both cup sizes vended
3. CONTINUE.

SET UP DELIVERY DOOR OPTIONS (Supervisor mode only)

1. Press , then press  until the display shows either:
 - DOOR ON** The automatic delivery door (if so equipped) is enabled.
 - OR**
 - DOOR OFF** The automatic delivery door (if so equipped) is disabled.
2. Press  to switch between these two choices.

NOTE

DOOR OFF must be selected if your machine does not have an automatic delivery door.

3. CONTINUE.

HOT DRINK SETUP/PROGRAMMING GUIDE

 **COLLECTING DRY PRODUCT GRAM THROWS**

Measuring the gram throw allows you to get the right amount of dry product or condiment into your hot drink. To do this, you need a container to catch the product throw and an accurate gram scale to measure its weight.

1. Make a measuring container by cutting down a paper cup until it fits under the canister spout as shown.
2. Weigh the measuring cup and zero the gram scale accordingly.
3. Make 5 test throws as instructed in the programming steps, then average the results.
4. Weigh the test throw.
5. Repeat steps 3 and 4 until you get the correct product or condiment weight.

Tables D1 and D2 show the factory default settings for the various dry products sold by the merchandiser. They are good starting points for you to use in setting up your machine. In the end, the amount of dry product or condiments you use in your drinks depends upon taste and manufacturers' recommendations. Recommended weights and times are for guidance only, and you do not have to adhere to them.

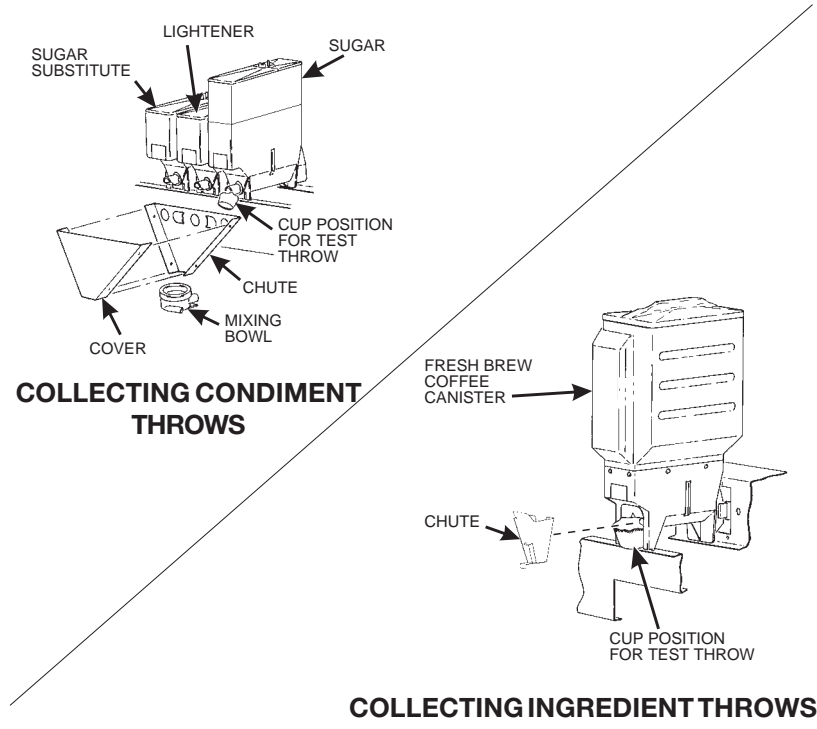

HOT DRINK SETUP/PROGRAMMING GUIDE

Table D1. Dry Product Weight and Throw Time Factory Default Settings

Selection		Weight (in grams) per size cup					
		Throw times (in seconds) per size cup					
		5 oz	7 oz	8 oz	9 oz	10 oz	12 oz
A	Fresh brew coffee	5.70	8.00	9.00	10.00	11.00	13.00
		1.60	2.20	2.50	2.80	3.10	3.65
A	Freeze dry coffee	0.90	1.20	1.50	1.60	1.80	2.20
		0.35	0.50	0.60	0.65	0.70	0.90
A	Strong freeze dry coffee	1.10	1.50	1.80	2.00	2.20	2.60
		0.65	0.90	1.10	1.20	1.35	1.60
B	Fresh brew decaf	5.70	8.00	9.00	10.00	11.00	13.00
		1.60	2.20	2.50	2.80	3.10	3.65
B	Freeze dry decaf	0.90	1.20	1.50	1.60	1.80	2.20
		0.35	0.50	0.60	0.65	0.70	0.90
B	Strong freeze dry decaf	1.10	1.50	1.80	2.00	2.20	2.60
		0.65	0.90	1.10	1.20	1.35	1.60
D	Fresh brew coffee ESPRESSO	5.70	8.00	9.00	10.00	11.00	13.00
		1.60	2.20	2.50	2.80	3.10	3.65
D	Freeze dry coffee ESPRESSO	0.90	1.20	1.50	1.60	1.80	2.20
		0.35	0.50	0.60	0.65	0.70	0.90
D	Strong freeze dry coffee ESPRESSO	1.10	1.50	1.80	2.00	2.20	2.60
		0.65	0.90	1.10	1.20	1.35	1.60
E	Fresh brew coffee CAPPUCCINO	5.70	8.00	9.00	10.00	11.00	13.00
		1.60	2.20	2.50	2.80	3.10	3.65
E	Freeze dry coffee CAPPUCCINO	0.90	1.20	1.50	1.60	1.80	2.20
		0.35	0.50	0.60	0.65	0.70	0.90
E	Strong freeze dry coffee CAPPUCCINO	1.10	1.50	1.80	2.00	2.20	2.60
		0.65	0.90	1.10	1.20	1.35	1.60
F	Instant tea	0.90	1.20	1.50	1.60	1.80	2.20
		0.70	1.00	1.25	1.30	1.60	1.85
F	Strong instant tea	1.10	1.50	1.80	2.00	2.20	2.60
		0.90	1.25	1.60	1.75	1.85	2.10
G	Chocolate	17.00	24.00	28.00	31.00	34.00	41.00
		2.80	4.00	4.65	5.15	5.65	6.80
H	Soup	4.30	6.00	7.00	7.60	8.50	10.20
		0.70	1.00	1.15	1.25	1.35	1.65
H	Soluble Product	10.0	13.5	16.2	17.8	19.7	23.7
		2.45	3.35	4.00	4.35	4.85	5.80

DRY PRODUCT WEIGHT AND THROW TIME FACTORY DEFAULT SETTINGS

HOT DRINK SETUP/PROGRAMMING GUIDE

Table D1. Dry Product Weight and Throw Time Factory Default Settings
(Continued)

Selection		Weight (in grams) per size cup*					
		Throw times (in seconds) per size cup					
		5 oz	7 oz	8 oz	9 oz	10 oz	12 oz
I	Chocolate used in cappuccino	3.10 0.55	4.50 0.75	5.00 0.85	5.80 1.00	6.20 1.05	7.60 1.30
D	Sugar used in espresso	2.10 0.35	3.00 0.45	3.50 0.55	4.00 0.60	4.50 0.65	5.50 0.80
D	Extra sugar used in espresso	3.00 0.50	4.35 0.65	4.80 0.75	5.35 0.80	6.25 0.90	7.20 1.05
E	Sugar used in cappuccino	3.50 0.45	5.10 0.65	6.00 0.75	6.80 0.85	7.70 0.95	9.40 1.20
E	Extra sugar used in cappuccino	4.60 0.60	6.80 0.90	7.70 1.00	8.50 1.10	9.40 1.20	11.00 1.45
F	Sugar used in tea	4.20 0.55	6.00 0.75	7.00 0.90	8.00 1.00	9.00 1.15	11.00 1.40
F	Extra sugar used in tea	5.50 0.70	8.00 1.00	9.00 1.15	10.00 1.25	11.00 1.40	13.00 1.65
F	Lightener used in tea	1.20 0.70	1.50 0.85	2.00 1.15	2.50 1.45	3.00 1.70	4.00 2.25
F	Extra lightener used in tea	1.50 0.85	2.00 1.15	2.50 1.45	3.00 1.70	3.50 2.00	4.50 2.60
F	Sugar substitute used in tea	0.60 0.75	0.85 1.05	1.00 1.25	1.10 1.35	1.30 1.60	1.50 1.90
F	Extra sugar substitute used in tea	0.80 1.00	1.10 1.35	1.30 1.60	1.40 1.75	1.60 2.00	1.90 2.40
*_ *	Sugar	4.20 0.55	6.00 0.75	7.00 0.90	8.00 1.00	9.00 1.15	11.00 1.40
*_ *	Extra sugar	5.50 0.70	8.00 1.00	9.00 1.15	10.00 1.25	11.00 1.40	13.00 1.65
*_ *	Lightener	1.20 0.70	1.50 0.85	2.00 1.15	2.50 1.45	3.00 1.70	4.00 2.25
*_ *	Extra lightener	1.50 0.85	2.00 1.15	2.50 1.45	3.00 1.70	3.50 2.00	4.50 2.60
*_ *	Sugar substitute	0.60 0.75	0.85 1.05	1.00 1.25	1.10 1.35	1.30 1.60	1.50 1.90
*_ *	Extra sugar substitute	0.80 1.00	1.10 1.35	1.30 1.60	1.40 1.75	1.60 2.00	1.90 2.40

D = Espresso

I = Chocolate times for cappuccino

E = Cappuccino

* The actual gram weight of a product or condiment throw will vary depending upon the type of product or condiment used. The weights given are approximate based upon factory testing.

* Separate sugar, lightener, and sugar substitute timers are available for selections A/B/C, D, E, and F.

 **CAPPUCCINO**

Cappuccino is made with various ratios of chocolate to coffee, according to taste. Lightener (E timer) is also used for cappuccino. Table D2 shows numerous different ways to make cappuccino for each size of cup in your machine. For example, the default chocolate-to-coffee ratio of 15 - 85 in a 7 oz. cup consists of the following:

- A chocolate throw (product I) lasting 0.55 seconds, providing 15% of the normal chocolate throw (approximately 4.5 grams*).
- A water throw for the chocolate (water I) lasting 2.55 seconds (chocolate product throw plus 2 seconds to ensure the mixing bowl is fully rinsed). The volume is about 56 ml, depending upon how the flow rate is adjusted.
- A throw for cappuccino coffee (product E) equal to a normal coffee (product A) throw.
- A water throw for the freeze dry coffee selection (water E) lasting for 4.35 seconds (101 ml).

OR

- A water throw for the fresh brew coffee selection (water E) lasting for 4.00 seconds (115 ml). **In either case the water volume is enough to fill the remainder of the cup.**

The actual mixing sequence is as follows:

1. The coffee portion of cappuccino is made using the same canister/valve combination as the normal (A) coffee.
2. After the coffee is completely in the cup, the chocolate portion is made with the selection G canister/valve combination. This gives the drink its traditional "layering".

* Chocolate weights will vary with different products.

HOT DRINK SETUP/PROGRAMMING GUIDE

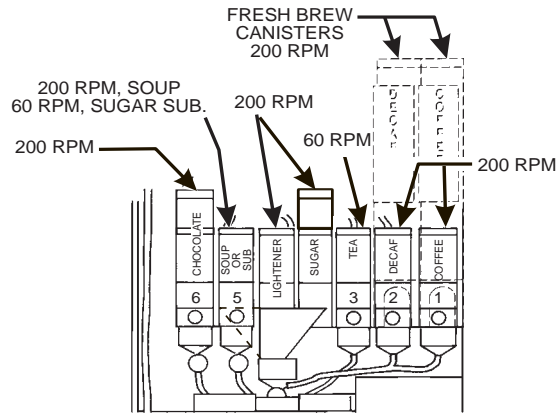

MOTOR SPEED BY LOCATION

HINTS:

To “fine tune” your Cappuccino drink to your exact taste, set a ratio close to what you like (between 15% and 50%), then turn ratio OFF. Adjust the individual timers until you are satisfied. You may find it necessary to cut down on the amount of sweetener available to a cappuccino drink with a high ratio of chocolate, as the chocolate contains sweetener of its own.

HOT DRINK SETUP/PROGRAMMING GUIDE

Table D2. Dry Product Settings for Cappuccino (5 oz. cup)

CHOCOLATE				FREEZE DRY COFFEE				FRESH BREW COFFEE			
Percent	Weight (gm)	Timing (sec)	Water Settings		Percent	Water Settings		Percent	Water Settings		
			Volume (ml)	Timing (sec)		Volume (ml)	Timing (sec)		Volume (ml)	Timing (sec)	
15 (default)	3.10	0.40	52	2.50	85 (default)	57	2.50	85 (default)	58	2.25	
20	4.10	0.55	54	2.60	80	54	2.35	80	55	2.15	
25	5.00	0.65	56	2.70	75	52	2.25	75	53	2.05	
30	5.80	0.75	59	2.85	70	49	2.10	70	49	1.90	
35	6.70	0.85	61	2.95	65	47	2.00	65	47	1.80	
40	7.60	0.95	63	3.05	60	44	1.85	60	45	1.70	
45	8.40	1.05	66	3.20	55	41	1.70	55	41	1.55	
50	9.30	1.15	68	3.30	50	38	1.60	50	38	1.45	

Table D2. Dry Product Settings for Cappuccino (7 oz. cup)

CHOCOLATE				FREEZE DRY COFFEE				FRESH BREW COFFEE			
Percent	Weight (gm)	Timing (sec)	Water Settings		Percent	Water Settings		Percent	Water Settings		
			Volume (ml)	Timing (sec)		Volume (ml)	Timing (sec)		Volume (ml)	Timing (sec)	
15 (default)	4.50	0.55	56	2.55	85 (default)	101	4.35	85 (default)	115	4.00	
20	5.80	0.70	59	2.70	80	97	4.20	80	110	4.85	
25	7.10	0.85	63	2.90	75	92	4.00	75	104	3.65	
30	8.00	0.95	65	3.00	70	90	3.90	70	102	3.60	
35	9.30	1.10	69	3.20	65	86	3.75	65	96	3.40	
40	10.50	1.25	72	3.35	60	81	3.55	60	92	3.25	
45	11.80	1.40	76	3.55	55	77	3.35	55	87	3.05	
50	13.10	1.55	79	3.70	50	72	3.15	50	83	2.90	

HOT DRINK SETUP/PROGRAMMING GUIDE

Table D2. Dry Product Settings for Cappuccino (8 oz. cup)

CHOCOLATE				FREEZE DRY COFFEE				FRESH BREW COFFEE			
Percent	Weight (gm)	Timing (sec)	Water Settings		Percent	Water Settings		Percent	Water Settings		
			Volume (ml)	Timing (sec)		Volume (ml)	Timing (sec)		Volume (ml)	Timing (sec)	
15 (default)	5.40	0.65	59	2.65	85 (default)	132	5.55	85 (default)	153	5.05	
20	6.80	0.80	62	2.80	80	128	5.40	80	150	4.95	
25	8.00	0.95	66	3.00	75	122	5.15	75	144	4.75	
30	9.30	1.10	69	3.15	70	117	4.95	70	137	4.50	
35	11.00	1.30	73	3.35	65	112	4.75	65	131	4.30	
40	12.70	1.50	78	3.60	60	108	4.60	60	124	4.05	
45	14.00	1.65	82	3.80	55	105	4.45	55	118	3.85	
50	15.65	1.85	85	3.95	50	91	3.85	50	112	3.65	

Table D2. Dry Product Settings for Cappuccino (9 oz. cup)

CHOCOLATE				FREEZE DRY COFFEE				FRESH BREW COFFEE			
Percent	Weight (gm)	Timing (sec)	Water Settings		Percent	Water Settings		Percent	Water Settings		
			Volume (ml)	Timing (sec)		Volume (ml)	Timing (sec)		Volume (ml)	Timing (sec)	
15 (default)	5.8	0.75	60	2.75	85 (default)	140	5.90	85 (default)	172	5.60	
20	7.6	1.00	64	2.95	80	134	5.65	80	155	5.05	
25	8.8	1.15	68	3.15	75	130	5.50	75	152	4.95	
30	10.5	1.35	72	3.35	70	125	5.30	70	144	4.70	
35	12.3	1.60	77	3.60	65	119	5.05	65	138	4.50	
40	13.9	1.80	82	3.85	60	113	4.80	60	133	4.35	
45	15.3	2.00	85	4.00	55	109	4.65	55	126	4.10	
50	17.1	2.25	90	4.25	50	105	4.50	50	124	4.05	

Table D2. Dry Product Settings for Cappuccino (10 oz. cup)

CHOCOLATE				FREEZE DRY COFFEE				FRESH BREW COFFEE			
Percent	Weight (gm)	Timing (sec)	Water Settings		Percent	Water Settings		Percent	Water Settings		
			Volume (ml)	Timing (sec)		Volume (ml)	Timing (sec)		Volume (ml)	Timing (sec)	
15 (default)	6.2	0.80	60	2.80	85 (default)	166	7.00	85 (default)	185	6.40	
20	8.0	1.05	65	2.95	80	161	6.80	80	178	6.15	
25	9.8	1.30	70	3.20	75	155	6.55	75	172	5.95	
30	11.3	1.50	74	3.40	70	150	6.35	70	167	5.80	
35	13.6	1.80	80	3.70	65	143	6.05	65	159	5.50	
40	15.3	2.05	85	3.95	60	137	5.80	60	152	5.25	
45	17.1	2.30	90	4.20	55	131	5.55	55	144	4.95	
50	18.7	2.50	94	4.40	50	126	5.35	50	138	4.75	

Table D2. Dry Product Settings for Cappuccino (12 oz. cup)

CHOCOLATE				FREEZE DRY COFFEE				FRESH BREW COFFEE			
Percent	Weight (gm)	Timing (sec)	Water Settings		Percent	Water Settings		Percent	Water Settings		
			Volume (ml)	Timing (sec)		Volume (ml)	Timing (sec)		Volume (ml)	Timing (sec)	
15 (default)	7.6	1.00	64	3.00	85 (default)	223	9.35	85 (default)	231	8.15	
20	9.8	1.30	70	3.30	80	215	9.00	80	223	7.85	
25	11.8	1.55	76	3.60	75	208	8.70	75	215	7.55	
30	13.9	1.85	82	3.90	70	201	8.40	70	207	7.25	
35	16.1	2.15	87	4.15	65	193	8.05	65	201	7.05	
40	18.2	2.45	93	4.45	60	185	7.70	60	193	6.75	
45	20.4	2.75	99	4.75	55	178	7.40	55	185	6.45	
50	22.3	3.00	105	5.05	50	171	7.10	50	178	6.20	

HOT DRINK SETUP/PROGRAMMING GUIDE

**CAFFÉ LATTE**

Caffe Latte has a rich, robust coffee flavor. It is a full-bodied hot beverage with extra creamer, whipped to frothy perfection, with sugar optional. Try this recipe to expand your gourmet product selections and increase premium pricing opportunities.

**ENTER THE SUPERVISOR CODE:**





1. Press . The display shows: *ENTER CODE*. You must enter the four-digit supervisor code within 6 seconds to gain access.

NOTE

A new machine has a factory-set supervisor code of *0000*.

When you have entered the right code, you will hear two beeps and see *SUPERVISOR* in the display.

**SET THE MACHINE TO VEND A LARGE "D" SELECTION:**

1. Press the following keys: , , and . The CONFIGURE screen is displayed.
2. Press  twice. The display should look something like this: *1. ABCDEFGH*. Make sure the "D" is displayed. If not, press "D" on the selection switch panel to display the "D".
3. Press  twice to return to the standby message.

 **SET UP YOUR SELECTION:**

Follow the instructions in the **PRODUCT CONFIGURATION** section of the *Hot DRINK Operator's Guide*.

1. Make sure the machine is configured to use 12 oz. cups.
2. Set up the 1D selection as follows:
 - a. Coffee: 17 grams
 - b. Sugar: 2.5 grams
 - c. Lightener: 5 grams
 - d. Water: 6 ounces (about 177 ml)
 - e. Steep time: 12.5 seconds
 - f. Whip: ON +

To get these measurements, refer to **PRODUCT CONFIGURATION**. See **COLLECTING DRY PRODUCT GRAM THROWS**, and perform test throws of the dry ingredients. See **COLLECTING WATER THROWS**, and perform test water throws.

 **EUROPEAN CAPPUCCINO**

First, a portion of cappuccino topping mix (or lightener) is dispensed, then layered on top is a small serving of strong coffee.

1. Replace product in the soup (or international coffee) canister with the lightener or cappuccino topping mix.

2. Enter the Supervisor code: Press . The display shows:

ENTER CODE. You must enter the four-digit supervisor code within 6 seconds to gain access.

NOTE

A new machine has a factory-set supervisor code of 0000.

When you have entered the right code, you will hear two beeps

and see **SUPERVISOR** in the display. Press .

3. Reconfigure the machine:

HOT DRINK SETUP/PROGRAMMING GUIDE

a. Press , then press  until the display shows *CONFIGURE*.

b. Press . The configuration code is displayed:

WXYZ, where W = the machine type, X = 6th product configuration, Y = brewer configuration, and Z = canister mapping. You will be changing the number represented by X. The only way to do that is to change all four numbers, so at this time write down your configuration code so you will know where to start if you make a mistake.

c. Replace "X" as follows:

If your current value of X is:	Change it to:
1	5
2	6
3	7
4	8

For example: If your current configuration code is *1234*, you will enter the numbers *1634*. Your new drink will be selected with the H key. Valid selections are H3 (black) and H4 (with sugar). After the reconfiguration, timers for the topping mix or lightener are under the J selection, and the timers for the coffee serving are under the H selection. Now, you need to alter the water throw times for the two selections. Consult the throw time tables for suggestions on a starting point for your new drink.

 **COLLECTING WATER THROWS**

National Vendors recommends the factory default times be used for water throws to ensure proper mixing. Table W1 gives the factory default water throw times for the various size cups and product selections.

WARNING

Water is **EXTREMELY HOT!** Be careful.

For a non-brewed selection, collect the water throws as follows:

1. Place a cup in the cup delivery station.
2. Ensure the merchandiser is using the factory defaults for the cup sizes (refer to PRODUCT CONFIGURATION).
3. Initiate the water throw for a selection.
4. Remove the cup and pour the water into a graduated cylinder.
5. Refer to table W1 for the correct volume of water.
6. Adjust the water valve for that selection and repeat steps 3 through 5 until the correct volume of water is thrown.

For a brewed selection, collect the water throws as follows:

1. Remove water supply hose from the brewer as shown on the next page.
2. Place the end of the hose in a graduated cylinder.
3. Ensure the merchandiser is using the factory defaults per table W1 for the cup sizes (refer to PRODUCT CONFIGURATION).
4. Initiate the water throw for a selection.
5. Refer to table W1 for the correct volume of water.
6. Adjust the water valve for that selection and repeat steps 3 through 5 until the correct volume of water is thrown.

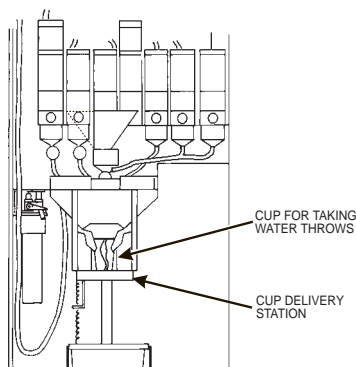

HOT DRINK SETUP/PROGRAMMING GUIDE

Table W1. Water Throw Default Times and Volumes

Selection	Time (in seconds) per size cup					
	Volume (in ml) per size cup					
	5 oz	7 oz	8 oz	9 oz	10 oz	12 oz
A Fresh brew coffee	4.50 130	6.40 190	7.50 220	8.20 240	9.00 265	11.00 315
B Fresh brew decaf	4.50 130	6.40 190	7.50 220	8.20 240	9.00 265	11.00 315
A Freeze dry coffee	4.95 120	7.00 170	8.25 200	8.65 210	9.90 240	12.60 305
B Freeze dry decaf	4.95 120	7.00 170	8.25 200	8.65 210	9.90 240	12.60 305
C 6th Product	4.85 100	6.80 140	8.25 170	8.75 180	9.70 200	11.65 240
D Espresso (FB)	2.25 65	3.20 95	3.75 110	4.10 120	4.50 133	5.50 158
D Espresso (FD)	2.50 60	3.50 85	4.15 100	4.35 105	4.95 120	6.30 153
F Tea	4.95 120	7.00 170	8.25 200	8.65 210	9.90 240	12.60 305
G Chocolate	4.85 100	6.80 140	8.25 170	8.75 180	9.70 200	11.65 240
H Soup	4.80 110	6.95 160	8.25 190	8.70 200	10.00 230	12.15 28H
H Soluble Product	4.85 100	6.80 140	8.25 170	8.75 180	9.70 200	11.65 240

WATER THROW DEFAULT TIMES AND VOLUMES

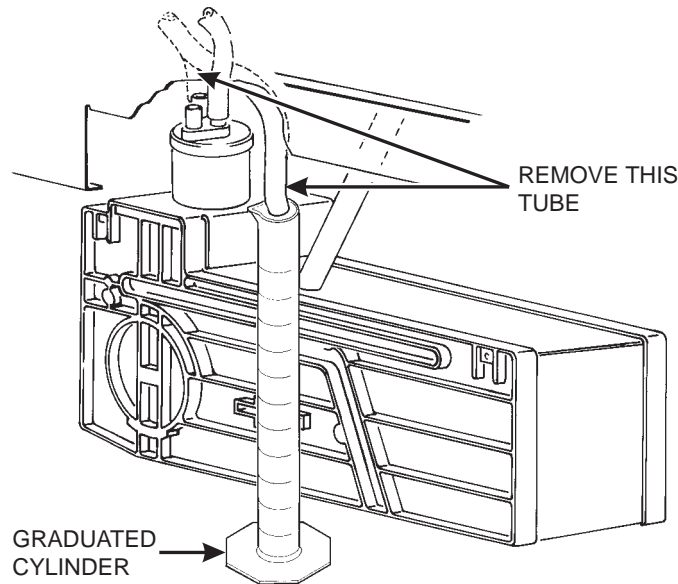





SET PRICES FOR INDIVIDUAL SELECTIONS

For this procedure, we will assume that the merchandiser is set up to vend two different sizes of cups. Also, the machine is configured to allow customers to vend a cup only (no drink). Here is an example of how to set prices for several different selections in this machine:

HELPFUL HINT

If most of the prices in your machine will be the same, perform the SET ONE PRICE FOR THE ENTIRE MACHINE procedure, then return to this procedure to set those prices which will be different.

1. Press . The display shows the maximum and minimum prices currently set in the machine.

2. Either press  to scroll through the selection list until you find the selection number you want.

OR

Go directly to the desired selection by pressing its letter.

To help you understand, here is an example. First, set the price for the *regular size C* selection to \$0.65. Press

0C, or  until . . .

3. . . . the display shows **C .55**. (The price for the **C** selection is currently at \$0.55.) Enter the new price (65 cents) using the number keys.

Now, set the price for the *large size D* selection. Press

1D, or  until . . .



4. . . . the display shows **1D.75** This is the **D** selection price for the large size cup (the "1" means the large cup).

5. CONTINUE.

HOT DRINK SETUP/PROGRAMMING GUIDE





SET THE PRICE FOR A CUP ONLY

1. Press , then press  until the display shows **2** **.XX**. "XX" represents the price for a cup only.
2. Enter the new price using the number keys.
3. CONTINUE.



SET ONE PRICE FOR THE ENTIRE MACHINE

1. Press . The display shows **##** **.XX** **.YY**. This is the maximum (XX) and minimum (YY) prices currently set in the machine.
2. Press . The display shows **##**.



CAUTION

Setting all prices in the machine will currently set prices. If you are sure you want to do this, go to the next step. If not, go to step 5.

4. Enter a new price.
5. CONTINUE.



SET ONE PRICE FOR ALL REGULAR SIZE DRINKS

1. Press . The display shows **##** **.XX** **.YY**. This is the maximum (XX) and minimum (YY) prices currently set in the machine.
2. Press **0** (on the selection switch panel) and . The display shows **0.##**.

CAUTION



Setting these prices will currently set prices. If you are sure you want to do this, go to the next step. If not, go to step.

3. Enter a new price.
4. CONTINUE.

HOT DRINK SETUP/PROGRAMMING GUIDE



SET ONE PRICE FOR ALL LARGE SIZE DRINKS

1. Press . The display shows **## .XX .YY**. This is the maximum (XX) and minimum (YY) prices currently set in the machine.
2. Press **1** (on the selection switch panel) and . The display shows **1#**.

CAUTION

Setting these prices will currently set prices. If you are sure you want to do this, go to the next step. If not, go to step 5.

3. Enter a new price.
4. CONTINUE.



SET THE TIME

1. Press . The display shows **TIME H.MM "H.MM"**. "H.MM" is the time of day currently set in the machine.
2. To change the time, just enter the time with the number keys using a 24-hour format (1300 = 1:00 pm).



NOTE

The new time will be displayed, but not updated in the system until you press an arrow key or .

3. CONTINUE.



SET THE DAY OF THE WEEK

1. Press , then press  until the display shows **□ SMTWTFS**. The currently set day of the week will be flashing. If it is correct, CONTINUE.
2. To change the day, press  until the correct day is flashing.
3. CONTINUE.

HOT DRINK SETUP/PROGRAMMING GUIDE



SET THE DATE AND YEAR

1. Press , and press  until the display shows
MM/DD YY.

"MM/DD YY" is the month, date, and year currently set in the machine. The slash (/) means that the U.S. date format is being used.

2. If desired, enter a new month, date, and year with the number keys.

- To change to the European date format (*DDMMYY*),

press . The display is now shown with the date before the month, and the slash (/) is replaced by a dash (-) to avoid confusion.

3. CONTINUE.



SET TIME-OF-DAY INHIBITED VENDING

Vending can be inhibited up to four times a day. This is useful when you don't want the machine used for any reason.

1. Press , then press  until the display shows
INHIB - - - - ..

2. Go to the **TIME INTERVAL EDITING** procedure for an example of how to set up time-of-day inhibited vending.

 **SET TIME-OF-DAY DISCOUNT VENDING**

Vending can be discounted up to four times a day. For example, this can be used to favor early-arriving employees.

1. Press , then press  until the display shows

DISCT - - - - .

2. Go to the **TIME INTERVAL EDITING** procedure for an example of how to set up **Time-of-Day Discount Vending**.

 **SET TIME-OF-DAY FREE VENDING**

Vending can be free up to four times a day.

1. Press , then press  until the display shows

FREEV - - - - .

2. Go to the **TIME INTERVAL EDITING** procedure for an example of how to set up time-of-day free vending.
3. **CONTINUE**.keys to enter a new time, if desired. Range: 2.0 - 12.5 hours, in .1 hour (6 minutes) increments.
3. **CONTINUE**.

CUSTOM TIME INTERVALS Times when normal vending is suspended in favor of special cases. For example, coffee could be discounted before working hours in the morning to favor early-arriving employees.



TIME INTERVAL EDITING

You can select up to four times of day for each special vending period.

NOTE

If two or more of these time periods overlap, the interval with the highest priority will overrule the other(s). This order of precedence is:

1. INHIBIT
2. FREEVEND
3. DISCOUNT

For example, if a DISCOUNT time period is scheduled before the end of an INHIBIT time period, DISCOUNT does not begin until the INHIBIT interval has ended.

The time interval editing procedure is almost the same for the INHIBIT, FREEVEND, and DISCOUNT intervals. There is one difference for the DISCOUNT time interval, so that interval will be shown here.

1. The display shows *DISCT 1234*. Press the number of the time interval you want to edit, or  to edit time interval 1 (we'll use interval 1 for this example).

2. The display shows *1.DISCT ON OR 1.DISCT OFF*. This display tells you whether your time interval (represented by X) is on or off.

Press  to change the condition of the time interval.

NOTE

If you turn an interval ON, it must be edited. You can edit a time interval now, then turn it OFF until later.

HOT DRINK SETUP/PROGRAMMING GUIDE

3. Press . The display shows *1.DSCT XX* This is the discount percentage for this period. Enter a discount percentage of 25 with the number keys.

4. Press . The display shows *1.STRT X.XX* "X.XX" is the currently set start time. Enter a new start time (24-hour format) for this interval. To enter the time for 3:30 pm, enter **1530**.

5. Press . The display shows *1.STOP X.XX*. "X.XX" is the currently entered stop time. Enter a new stop time (24-hour format) for this interval. To enter a stop time of 6:00 pm, enter **1800**. You have now established a 25% discount that starts at 3:30 pm and ends at 6:00 pm.

6. Press . The display shows *1.@- - - - -*. The dashes represent the days that this time interval is active. Pressing number keys 1 through 7 switches the days on/off. The days you select will appear in the display. Press **2, 4, and 6**. The display shows *1.@- W- F-*, meaning that the discount interval is only active on Monday, Wednesday, and Friday.

7. Press . The display shows *1.- - - - -*. The dashes represent the selections affected by this time interval. Press the appropriate letter key to turn the selections ON or OFF.

NOTE

Selections not vended by your machine will not be displayed. Press **A, B, F, and H**. The display shows
1. A B- - - F - H.

8. Press . The display shows either:

1. MMSG OFF There is no custom message selected.

OR

1. MMSG X. This means that custom message X (1 through 8) will be displayed during this time interval. Press the number key of the message you want displayed. Pressing **0** turns the message OFF for this time interval.

HOT DRINK SETUP/PROGRAMMING GUIDE

STANDBY The message that is displayed during normal vending periods when there are no out-of-service faults

(You can also press  to scroll through the message list.)

NOTE

YOU CAN SET UP THE CUSTOM MESSAGE BY FOLLOWING THE CUSTOM MESSAGE EDITING PROCEDURE.

9. CONTINUE.



SELECT A STANDBY MESSAGE

1. Press , then press  until the display shows

STANDBY *MX*. "X" represents the current message number selected for the standby message. Two dashes mean that the factory-set message is selected.

2. To select a message, just press the corresponding number (1 through 8). To display the factory-set message, press 0.

OR

Press  to scroll through all eight messages and the factory-set message.

3. CONTINUE.

 **SELECT AN OUT-OF-SERVICE MESSAGE**

1. Press , then press  until the display shows *SERVICE*

XX. "XX" represents the current message number selected to display when the machine is out-of-service. Two dashes mean that the factory-set message is selected.

2. To select a message, just press the corresponding number (1 through 8). To display the factory-set message, press 0.

OR

Press  to scroll through all eight messages and the factory-set message.

3. CONTINUE.

 **SELECT A FREEVEND MESSAGE**

1. Press , then press  until the display shows

FREEVEND XX. "XX" represents the current message number selected for the message that displays when the machine is in the freevend mode. Two dashes mean that the factory-set message is selected.

2. To select a message, just press the corresponding number (1 through 8). To display the factory-set message, press 0.

OR







Press  to scroll through all eight messages and the factory-set message.

3. CONTINUE.

HOT DRINK SETUP/PROGRAMMING GUIDE



EDIT CUSTOM MESSAGES

1. Press , and press  until the display shows *EDIT*
MSG'S. Press the number of the message you want to edit. *MES*
SAGE X is displayed (X represents the message number you pressed).
2. Press . The message text is displayed with the first character flashing.
3. To view the message, press . The message scrolls across the display. To stop the scrolling, press .
4. When the character you want to change is flashing, either enter it directly, or use  and  to step through the character set until the desired character is displayed. Use the arrow keys to highlight different characters. See the section on the next page for an explanation of special keys and the character set.

SHORTCUT

Instead of stepping through the whole character set to enter a letter that is not on your keypad, enter one close to the one you want, then step to it. Example: If you want to enter an **L**, first press **J** on the selection switch panel.

Then press  twice. Your **L** should now be displayed.

THE END OF MESSAGE CHARACTER













This is the most important character in your message, because it tells the machine when the message is ended. If you don't use this character, your message will be followed by a bunch of zeros. This character can be selected either from the character set or by a direct

key entry (see the next page). 

HOT DRINK SETUP/PROGRAMMING GUIDE

ENTERING YOUR MESSAGE

You will be using a combination of special keys and the keys on the selection switch panel to enter your message. Pressing the keys on the selection switch panel will enter the character shown on that key. Most of the keys on the service keypad have a special purpose to help you create and edit your messages:

- | | | | |
|---|---|---|--|
|  | Inserts an R at the flashing character. |  | Inserts a space at the flashing character. |
|  | Inserts an S at the flashing character. |  | Deletes the current character and closes up the space. |
|  | Inserts a T at the flashing character. |  | Deletes the current character and leaves the space. |
|  | Repeats the letter to the left of the flashing character. |  | Enters the special "end of message" character, which denotes the end of the message. |
|  | "Pages" through the message, ten characters (one screen) at a time. |  | Steps forward and backward through the message, one character at a time. |
|  | | | |
|  | Steps forward and backward through the character list, one character at a time. |  | |

THE CHARACTER SET



0	A	K	U	{
1	B	L	V	}
2	C	M	W	#
3	D	N	X	*
4	E	O	Y	+
5	F	P	Z	-
6	G	Q	(SPACE)	/
7	H	R		.
8	I	S	\$	<
9	J	T	'	=

>
?
@
O
☒

THIS IS THE END OF MESSAGE CHARACTER.

HOT DRINK SETUP/PROGRAMMING GUIDE

TEST VEND SELECTIONS AND VERIFY CREDIT ADDED

1. Press . The display shows *TEST .00*. You may now test vend selections.
2. To test vend selections without dropping a cup, press . The display shows *TEST.NC .00*. No cups will drop during the rest of your test vend session. If desired, you may place money in the machine.





In either case, if you insert money into the machine, the zeros in the display will be replaced with the amount of the credit.

NOTE

You may make one more test vend if you close the door while still in TEST VEND mode.

3. CONTINUE.

TEST THE DISPLAY



1. Press , then press  until the display shows *DSPLY TEST.*
2. Press  to light all display segments and the "DRINK BEING SERVED" light; press  to turn them off.
3. Pressing a number key on the maintenance keypad, or any key on the selection switch panel causes all segments to display that character.

NOTE



To help differentiate the two keypads, a number from the maintenance keypad has an apostrophe after it: 1'. A number from the selection switch panel has a period after it: 1.

4. CONTINUE.



 **TEST THE CUP MECHANISM**

1. Press , then press  until the display shows **CUP TEST**.
2. You can test the cup mechanism one of several ways:
 - a. Press **1** or . A cup is dispensed from the cup ring.
3. CONTINUE.

 **TEST THE AUTOMATIC DOOR (OPTIONAL)**

1. Press , then press  until the display shows **DOOR TEST**.
2. Press  to test the automatic delivery door. The door will open, then close after one second.
3. CONTINUE.

 **TEST THE WHIPPERS**



1. Press , then press  until the display shows **WHIP TEST**.
2. Press the whipper number (1=whipper below main condiment mixing bowl, 2=soup whipper, or 3=chocolate whipper) you want to test.

OR

Press the letter of a selection containing a whipper.
In either case, **WHIP X** is displayed while the whipper under test ("X") runs.
3. CONTINUE.

HOT DRINK SETUP/PROGRAMMING GUIDE

TEST THE AIR COMPRESSOR



1. Press , then press  until the display shows **AIR TEST**.
2. Press  to test the air compressor.

NOTE

If the brewer is in the **BREW** position at the start of this test, the compressor runs for 18 seconds. This allows you to evacuate a full brewer barrel. Otherwise, it runs for 2 seconds.

3. CONTINUE.

TEST THE BREWER

1. Press , then press  until the display shows **BREW TEST**.
2. Press  to test each brewer position:

WARNING



Keep away from the brewer mechanism while it is operating. Coming into contact with moving parts could injure you.

- a. **BREW 'R BREW** The brewer is in the BREW position.
 - b. **BREW 'R FLIP** The brewer is in the FLIP position.
 - c. **BREW 'R HOME** The brewer is in the HOME position.
3. CONTINUE.





 **RINSE ALL MIXING BOWLS**

WARNING

**Very hot water will be dispensed in this test. Com-
ing into contact with hot water is dangerous!**

1. Press , then press  until the display shows **BOWL RINSE**.
2. Press  to rinse all bowls. **RINSING** is displayed.
3. CONTINUE.





 **VIEW FREEVEND SALES BY TIME INTERVAL
(NOT SHOWN IF ZERO)**

1. Press , then press  until the display shows **_0\$ XX.XX**.
2. Press , then press  until the display shows **1.FRV .00**. This is the total sales for freevend interval 1, shown even if zero.
3. Press  to view intervals 2 through 4.
4. CONTINUE.

HOT DRINK SETUP/PROGRAMMING GUIDE







VIEW DISCOUNT SALES BY TIME INTERVAL

1. Press , then press  until the display shows
##\$ XX.XX.
2. Press . The display shows **1.DSC .00**. This is the total sales for discount interval 1 (not shown if zero).
3. Press  to view intervals 2 through 4.
4. CONTINUE.







VIEW FREE VENDS (NOT SHOWN IF ZERO)



1. Press , then press  until the display shows
_0\$ XX.XX.
2. Press , then press  until the display shows
FRV XX.XX. "XX.XX" is the total machine-wide freevends, shown even if zero.
3. CONTINUE.

HOT DRINK SETUP/PROGRAMMING GUIDE

VIEW WINNERS (NOT SHOWN IF ZERO)

1. Press , then press  until the display shows
_0\$ XX.XX.
2. Press , then press  until the display shows
WIN XX.XX. "XX.XX" is the total machine-wide winners, shown even if zero.
3. CONTINUE.

VIEW TIME DATA

1. Press , then press  until the display shows
TIME DATA.
2. Press . The following message scrolls across the display:

MAIN.1 237M 01/30 10.13

This example shows the latest time interval the main (machine) door was open (1). It was open for 237 minutes, and was opened

On January 30 (01/30) at 10:13 am (10.13). Press . If applicable, similar displays will appear for intervals 2, 3, and 4, otherwise, go to the next step.

3. Press . The following message scrolls across the display:

LAST POWER 01/30 13.51 FOR 00. 0.23

This example shows that the last time the machine lost power was on January 30 (01/30) at 1:51pm (13.51) for zero days, zero hours, and 23 minutes (00. 0.23).

HOT DRINK SETUP/PROGRAMMING GUIDE

4. Press . The following message scrolls across the display:

LONGS.T POWER 01/30 10.58 FOR 00. 2.47

This example shows that the longest time the machine was without power was on January 30 (01/30) at 10:58am (10.58) for zero days, 2 hours and 47 minutes (00. 2.47).

5. Press . The following message scrolls across the display:

FULL CLEAR 01/30 8.58

This example shows that the last time resettable sales was fully cleared was on January 30 (01/30) at 8:58am (8.58).

6. Press . The following message scrolls across the display:

TIME SET 01/30 9.15

This example shows that the last time the time or date was set was on January 30 (01/30) at 9:15 am (9.15).

7. Press . The following message scrolls across the display:

PRICE SET 01/30 9.42

This example shows that the last time prices were set was on January 30 (01/30) at 9:42 am (9.42).

8. CONTINUE.



NOTE

Refer to (VIEW DATA THREE DIFFERENT WAYS, page 83) to view the date and time of the last vend of that selection.



 **VIEW TOTAL UNPAID SALES**

NOTE



This does not appear if the total of unpaid sales is zero.

1. Press , then press  until the display shows **_0\$**
XX.XX. "XX.XX" is the total unpaid sales (free vends, winner vends, 100% discounts, zero price vends) for the entire machine.
2. If desired, view this data by tray and individual selection.
3. CONTINUE.

 **VIEW TOTAL UNPAID VENDS**

1. Press , then press  until the display shows **_0**
XX. "XX" is the total number of unpaid vends for the entire machine.
2. If desired, view this data by tray and individual selection.
3. CONTINUE.

 **VIEW NUMBER OF TEST VENDS (NOT SHOWN IF ZERO)**



1. Press , then press  until the display shows **TST**
X. "X" is the number of test vends.
2. If desired, view this data by cup size and individual selection.
3. CONTINUE.

 **VIEW SALES DATA BY PRICE**

You can view the total sales of each separate price in the machine.

1. Press , then press  until the display shows **##\$**
XX.XX.

HOT DRINK SETUP/PROGRAMMING GUIDE

2. Press . The display shows the lowest price followed by the dollar sales of all selections costing that price.
3. Press  to step through all the prices set in the machine.
4. CONTINUE.



SET FREEVEND OPTIONS

1. Press  until one of the following is displayed:

FREEOFF - Normal vending mode. No items are on freevend. A closure on the keyswitch input causes the machine to go out of service.

- OR -

FREEALL - All items are on freevend. The credit display shows
NO MONEY REQUIRED

A closure on the keyswitch causes the machine to go out of service.

- OR -



FREEW/KEY - All items are freevended while there is a closure on the keyswitch input. Normal cash sales are supported when the keyswitch input is open. If the free vend code (selected under SUPERVISOR MODE) is not 0000, the code must be entered first.

- OR -

FREEONCE - A closure on the keyswitch input causes only the next item to be freevended. Coin mechanism errors are ignored. This state is designed for card or token systems where one item is vended per token. Normal cash sales are also supported.

2. Press  until the option you want is displayed.
3. CONTINUE

 **VIEW MACHINE ID NUMBER**

1. Press , then press  until the display shows *i.D.* **XXXXXX**. The X's represent the 6-digit machine ID number.

2. CONTINUE.

 **VIEW NON-RESETTABLE SALES AND VEND DATA**



1. Press . The display shows **NRS** **XX.XX**. "XX.XX" is a dollar and cents figure showing the total of all sales in the machine. This is a running total, and is not resettable.

2. Press . The display shows **NR** **X**. "X" is the total number of vends made by the machine. This is a running total, and is not resettable.

3. CONTINUE.

 **VIEW DATA THREE DIFFERENT WAYS**

Paid sales and vends can be viewed three different ways: By whole machine, by selection type, and by individual selection. The first screen of the data item shows its machine total.

- To view the data by selection type, press the letter of the type you want to see. For example, pressing **A** shows you the total sales and vends for the combined regular and large size cups of the A selection. You can then press  and  to see data for all the active selection types.

- To view the data by individual selection, press the letter and

number of the selection you want to see. You can then press 

and  to see data for all the active selections.



- If viewing data by individual selection, press  to view the date and time of the last vend of that selection.
-

HOT DRINK SETUP/PROGRAMMING GUIDE



RINSE THE BREWER

WARNING

Very hot water will be dispensed in this test. Coming into contact with hot water will HURT!

1. Press , then press  until the display shows **BREW RINSE**.
2. Press  to rinse the brewer. The brewer cycles, and **RINSING** is displayed.
3. CONTINUE.

FILL THE TANK

1. Press , then press  until the display shows **TANK.FILL**.
2. Press . This clears any tank error and starts filling the tank, if necessary.

NOTE

If it is taking a long time to fill the tank **AND THERE ARE NO LEAKS**, you may see **TANK ERR** in the diagnostic list again.

Just press  again after making sure there are no other problems, such as a restriction in the water inlet line or a clogged water filter.

3. CONTINUE.

 **TEST VARIOUS SENSORS AND SWITCHES**

1. Press , then press  until the display shows **IN.XXXXXX**. The X's in the display will be replaced by the following place holders:

M K P H L 1, defined as follows:

M = mug/cup sensor (if equipped) K = freevend keyswitch
P = waste pail switch H = high water tank level switch
L = low water tank level switch 1/2 = ring 1/2 cup sensor switch

2. Actuate each switch or sensor to test its function. As you actuate each input, the display element representing that switch blinks on. Releasing the switch causes that element to blink off again, and be replaced by a dash.

3. CONTINUE.
-

 **PAYOUT COINS**

1. Press . If a dumb mech was selected, the display shows

NDQ =123; if an MDB mech was selected the display shows **PAY 123**.

2. Press . A dumb mech pays out one Nickel; an MDB mech

pays a coin from tube 1. Press . A dumb mech pays out one

Dime; an MDB mech pays a coin from tube 2. Press . A

dumb mech pays out one **q**uarter; an MDB mech pays a coin from tube 3.



3. To continuously pay out coins, hold down the appropriate key.

4. CONTINUE.
-

HOT DRINK SETUP/PROGRAMMING GUIDE





VIEW TOTAL PAID SALES

1. Press , then press  until the display shows **##\$
XX.XX**. "XX.XX" is a dollar and cents figure showing the total of all **PAID** sales in the machine (as opposed to unpaid sales like winner and free vends). This is the total since the last time it was cleared.
2. If desired, view this data by cup size and individual selection.
3. CONTINUE.





VIEW CARD READER PAID SALES (NOT SHOWN IF ZERO)

1. Press , then press  until the display shows **##\$
XX.XX**.
2. Press . The display shows **DBT XX.XX**. "XX.XX" is the amount of money collected from card reader sales.
3. CONTINUE





VIEW TOTAL PAID VENDS



1. Press , then press  until the display shows **## XX**. "XX" is the total number of paid vends for the entire machine.
2. If desired, view this data by cup size and individual selection.
3. CONTINUE.

HOT DRINK SETUP/PROGRAMMING GUIDE



CLEAR ALL RESETTABLE DATA

1. Press . The display shows *NRS* **XX.XX**. This is a running total, and is not resettable.
2. Press and hold . Two beeps sound and the display shows *CLEARING* momentarily, and then changes to *FINISHED*. All data is cleared.
3. CONTINUE.

CLEAR PAID SALES DATA ONLY



1. Press , then press  until the display shows *##* **\$** *XX.XX*. "XX.XX" is a dollar and cents figure showing the total of all **PAID** sales in the machine (as opposed to unpaid sales like winner and free vends). This is the total since the last time it was cleared.
2. Press and hold . Two beeps sound and the display shows *CLEARING* momentarily, and then changes to *FINISHED*. All paid sales data is cleared; other data is not cleared.
3. CONTINUE.



VIEW AMOUNT IN COIN BOX (NOT SHOWN IF ZERO)

1. Press , then press  until the display shows *CBX* **XX.XX**.
"XX.XX" is the dollar and cents amount in the coin box.
2. CONTINUE.

HOT DRINK SETUP/PROGRAMMING GUIDE

VIEW AMOUNT IN VALIDATOR (NOT SHOWN IF ZERO)

1. Press , then press  until the display shows
DBV XX.XX.
"XX.XX" is the dollar amount in the bill stacker.

2. Press  to show the quantities of bills in the stacker. For example, the display shows **\$0120**, meaning that there are 20 dollar bills in the bill stacker. Press  again to show the quantities of other bills, such as \$5s, \$10s, or \$20s.

3. CONTINUE.

VIEW DIAGNOSTIC MESSAGES

Press . The display shows any of the following diagnostic messages, depending upon any fault(s) present:

NO ERRORS	None of the following errors are detected:
KEYPAD XY	Key(s) x, y stuck.
ROM ERROR	Key(s) x, y stuck.
RAM ERROR	RAM is not initialized or is not compatible with the currently loaded software. If this message appears, initialize your RAM by performing the following procedure:

NOTE:

**Initializing RAM will erase all your data and drink settings.
Be sure you have written this information down before continuing.**

Press and hold  until two beeps are heard, and the display shows **FINISHED**.

HOT DRINK SETUP/PROGRAMMING GUIDE

<i>KEYSWITCH</i>	The keyswitch input is active and configured as an inhibit.
<i>MACH.TYPE 0</i>	Machine type error displays machine type screen. NOTE: This is the actual machine type screen. You may enter the correct machine type number directly on this screen without further action.
<i>D+J+WXYZ</i>	Configuration error; displays the machine configuration screen. NOTE: this is the actual config screen. You may enter the correct config number directly on this screen without further action. (Verify cup size and product times in the product configuration  screen).
<i>TANK ERR</i>	Tank failed to fill or refill.
<i>RING 1, 2</i>	The cup ring is jammed.
<i>MTR 1A1B2X</i>	Cup turrets are jammed.
<i>NO CUPS 1, 2</i>	Out of cups.
<i>BREW JAM</i>	The brewer is jammed.
<i>WASTE PAIL</i>	The waste pail is full.
<i>LOW WATER</i>	The water level in the tank is low.
<i>COLD WATER</i>	Water in the tank is too cold to vend.
<i>NO SENSOR</i>	Temperature sensor failed or missing.
<i>NO FLOAT</i>	Float sensor failed or missing.
<i>WHIP 1 2 3 4 5</i>	Whipper motor failure (motor 1, 2, 3, 4, 5)
<i>DOOR JAM</i>	The automatic delivery door is jammed.
<i>NO MECH</i>	Coin mech not detected - machine will not operate if configured for coin mech

HOT DRINK SETUP/PROGRAMMING GUIDE

<i>MECH COMM</i>	Incomplete coin mech communications check harness.
<i>MECH.SENSOR</i>	Coin mech reporting a bad tube sensor replace mech.
<i>MECH ROM</i>	Replace the coin mechanism.
<i>MECH.ACCEPT</i>	Coin mechanism acceptor section is unplugged from the main body of the coin mech. Connect the cable and cycle machine power OFF and then ON.
<i>MECH JAM</i>	One or more coin tubes are jammed. Pay a coin from each tube until the jam is cleared.
<i>DEBIT CARD</i>	Card reader reporting error — machine will not operate if configured for DEBIT ONLY.
<i>CHECK DBV</i>	Bill validator reporting error — machine will not operate. Empty stacker, clear jams, etc.
<i>DBV COMM</i>	Incomplete bill validator communications — check harness.
<i>DBV MOTOR</i>	One of the motors has failed. The unit will disable itself until the error is corrected. Check for bill stuck in the acceptance path. If no bill is present, replace the validator. Cycle machine power OFF and then ON.
<i>DBV SENSOR</i>	One of the sensors in the bill validator has failed. The unit will disable itself until the error is corrected. Check for bill stuck in the acceptance path. If no bill is present, replace the validator. Cycle machine power OFF and then ON.

HOT DRINK SETUP/PROGRAMMING GUIDE

<i>DBV JAM</i>	A bill is jammed in the acceptance path. The unit will disable itself until the error is corrected. Remove bill stuck in the acceptance path. Cycle machine power OFF and then ON.
<i>DBV STACKR</i>	The stacker is open or removed. The unit will disable itself until the error is corrected. Install the stacker correctly.
<i>CHK PRICE</i>	Price error detected and changed to maximum - check prices.
<i>NONE READY</i>	All selections are reported out of service.
<i>PV.ERR CUP 1</i>	Cup ring 1 is out of service due to a PosiVend™ error.
<i>PV.ERR CUP 2</i>	Cup ring 2 is out of service due to a PosiVend™ error.
<i>PV.ERR PCB</i>	PosiVend™ is ON but not working. The last calibration sample was 255. Check that the PosiVend™ PCB is present at J34.
<i>PV.ERR SNSR</i>	PosiVend™ is ON but not working. The last calibration sample was ≤50. Check for a blocked sensor or disconnected harness.
<i>AJP.TMR1 XX</i>	PosiVend™ is active and ring 1 anti-jackpot timer is ON. XX is a value between 1 and 99 in minutes.
<i>AJP.TMR2 XX</i>	PosiVend™ is active and ring 2 anti-jackpot timer is ON. XX is a value between 1 and 99 in minutes, and represents the amount of time left on the anti-jackpot timer for this cup ring.
<i>NO BREWJER</i>	Brewer is missing or malfunctioning.

HOT DRINK SETUP/PROGRAMMING GUIDE

<i>BREWER.ERR</i>	The brewer is in an incorrect position.
<i>BREWER JAM</i>	The brewer has not reached an appropriate position within a certain time-out period. Check for a physical jam or a motor stall condition.
<i>RESET BRUJR</i>	The brewer is clamped and not vending, or is not in a brewer test mode. Close the door (if open), or run a brew test.



DOWNLOAD DATA TO A PDCD

1. Connect your portable data collection device (PDCD) in accordance with its operating instructions.

2. Press . Data is downloaded into your PDCD.



NOTE

Depending upon the setting selected in (**SET PRINTER DEX OPTIONS** , page 31). Data may be cleared after the download is complete.

3. Continue.

 **CHANGE MACHINE ID NUMBER**

1. Follow the steps in **GAIN ACCESS TO THE SUPERVISOR MODE**.

2. Press , then  until the display shows **I.D. XXXXXX**. The X's represent the 6-digit machine ID number.

3. Using the number keys, enter a new ID number.

4. CONTINUE.

 **VIEW THE WATER TANK TEMPERATURE**

1. Press . The display shows **TEMP XX F**. This is the current water tank temperature (in degrees F or C, depending upon your choices).

2. CONTINUE.

 **VIEW THE CURRENT SOFTWARE VERSION NUMBER**



1. Press , then press  until the display shows **VER XXXX**. This is the current software version number.

2. CONTINUE.

HOT DRINK SETUP/PROGRAMMING GUIDE



VIEW THE SELECTION MACHINE TYPE

1. Press  then  until the display shows *MACH.TYPE (X)*.

This is machine type,
(See Machine Type for explanation of *(X)*).

2. Continue.



VIEW THE SELECTION MACHINE TYPE CONFIGURATION

1. Press , then press  until the display shows

CONF WXYZ. This is the machine type configuration. (See PRODUCT CONFIGURATION for an explanation of "W", "X", "Y", and "Z").

2. CONTINUE.



VIEW THE SELECTION CONFIGURATION

1. Press , then press  until the display shows

0.ABCDEFGH. This shows which selections are available for sale and setup for regular size drinks. If one or more of the letters in the display are replaced by dashes (-), that selection is unavailable.

2. Press . The display shows *1.ABCDEFGH*. This shows which selections are available for sale and setup for large size drinks. If one or more of the letters in the display are replaced by dashes (-), that selection is unavailable.

3. CONTINUE.

SANITATION

Basics

INTRODUCTION

Anybody who services vending machines must use proper sanitizing procedures. Health regulations require that hands be clean when cups, commodities, and food-contact parts are handled or serviced.

In addition, Federal and State Health Departments require regular cleaning and sanitizing procedures for food contact parts.

The information in this section will explain how to clean and sanitize the merchandiser on a day to day basis. A clean and well maintained merchandiser will provide a better product and greater safety for your customers.

CLEANING AND SANITIZING -- WHAT'S THE DIFFERENCE?

Clean means "free of visible soil". In cup vending machine servicing, cleaning is also done to maintain product quality and to remove food soils, oils, and mineral stains that could affect product taste, aroma, and appearance.

Sanitizing means the reduction, to safe levels, of the number of disease-causing bacteria that remain on the surface **after** cleaning. Therefore, cleaning and sanitizing are done in separate steps, as prescribed by health regulations and good industry practice.

When you sanitize you create a healthy and hygienic condition. This leads to wholesome food, which in turn leads to satisfied customers.

SANITIZING IS NO SUBSTITUTE FOR A GOOD CLEANING

HOW DO I SANITIZE?

You can sanitize by using either of these two methods:

Chemicals: The object to be sanitized is treated with a bactericidal compound.

Heat: Raise the temperature of the object high enough to kill bacteria. Water must be at least 170° F.

Hot brew water (if available) is an acceptable sanitizer. When food contact surfaces are washed and/or rinsed, use the hot water available in the machine.

Turn the machine off before using water on the machine.

In either case, the object must be thoroughly clean and completely rinsed in order for the sanitizing process to work. Caked-on soils not removed by cleaning, for example, may shield bacteria from a sanitizing solution.

HOT DRINK SETUP/PROGRAMMING GUIDE

A GOOD PLACE TO START -- YOUR SANITATION KIT

You need to be sure that each machine is clean, safe, and functioning when you leave it. In order to properly do this, you need to have a complete set of the right tools. In addition to the screwdrivers, pliers, and test equipment necessary to repair a machine, you need to have the tools to clean the machine.

Here is a checklist of the items needed for a good sanitation kit:

- Sanitation pail
- Tube and nozzle brushes for food contact surfaces
- Utility brush for dry spillage around canisters, etc.
- Disposable towels, wet-strength and lint-free

NOTE

Wiping with towels can re-contaminate sanitized food-contact parts. Therefore, towels should not be used to dry food-contact surfaces. Instead, these parts should be air dried.

- Spray detergent, diluted to desired strength
- Urn cleaner packets for coffee stains and oils
- Odor control chemicals for pails
- Replacement parts (if the exchange method is used)
- Cabinet polish or window cleaner for the outside of the machine

Feel free to add some items to this list. For example, you may want to use a portable vacuum cleaner.

SANITATION PROCEDURES

Refer to the recommended cleaning and sanitation interval table on the final page of this section. For each item, complete the procedure as outlined here.

Food-Contact Parts

NOTE

**All food-contact parts must be cleaned and sanitized.
Air dry, do not wipe dry.**

Ingredient Canisters - Empty and wash the canisters, augers, and spouts. Sanitize with hot water and allow to air dry completely before returning to cabinet.

Mixing Bowls - The inside of all mixing bowls can be rinsed by performing the "Bowl Rinse" operation as outlined in the Programming section of this manual.

If needed, remove mixing bowls from the dry ingredient shelf. Wash the mixing bowl lids and sanitize with hot water. Allow to completely air dry before reassembling.

Whipper Lids and Impellers - Remove lids and impellers from the whipper housings, wash the lids and impeller housing. Sanitize with hot water and allow to air dry before reassembling.

HOT DRINK SETUP/PROGRAMMING GUIDE

Beverage Discharge Nozzles - Disconnect the beverage dispensing tube from the nozzles. Remove the nozzles from the mounting bracket. Remove the cap from the nozzle, wash clean and sanitize the nozzles and cap. Refer to the tubing connection diagram for proper routing.

Brewer, Brewer Basket, and Brewer Funnel - The tubing and brewer may be sanitized by performing the BREW RINSE operation as outlined in the programming section. The machine features an automatic brewer sanitizing feature also described in the programming section.

At times, it may be necessary to wash and sanitize the individual brewer parts. If so, disconnect the tubes from the brewer manifold. Remove the brewer barrel and manifold assembly from its support. Remove the brewer basket and funnel assemblies.

Thoroughly wash all parts using soap and water. Sanitize by rinsing thoroughly with hot water.

Coffee Chutes - Remove the metal chute(s), wash clean, and sanitize by rinsing with hot water. Air dry before reinstalling.

Condiment Chute Assembly - Remove the condiment chute and cover from the condiment canisters. Thoroughly wash all parts using soap and water. Sanitize by rinsing thoroughly with hot water.

Non Food-Contact Parts

Brewer Mechanism Cleaning - Remove the brewer mechanism from its mounting and rinse with the spray hose.

Cup Delivery Compartment - Remove the compartment from the merchandiser. Wash clean and rinse with hot water.

Exhaust Fan Filter - Remove the filter from its housing. Wash with soap and water, rinse, wring dry, and replace into housing.

Grounds Pail - Empty and rinse the grounds pail. Reline the pail with a clean plastic liner.

Waste Pail - Empty, wash, and rinse with hot water. Sprinkle detergent powder in the bottom of the pail to help control odors.

Ingredient Rinse Tray - Remove product canisters. Wash and rinse with hot water. Allow to air dry.

OVERALL CLEANING

Inspect your merchandiser both inside and out. Be sure to check corners and all less visible parts of the merchandiser.

Clean where needed.

Allow the inside of the cabinet to dry thoroughly before you close the door.

HOT DRINK SETUP/PROGRAMMING GUIDE

National Vendors recommends using the following supplies:

A commercial glass cleaner on the glass in the cabinet door.

A mild detergent and warm water on the cabinet, brewer, and other NON ELECTRICAL components.

CAUTION

The plastic parts in your merchandiser should be cleaned with mild detergent and warm water. The use of other cleaning agents may damage the material, and should be avoided.

PREVENTIVE MAINTENANCE CLEANING

Periodically, you should visually inspect your merchandiser's hot water tank for excessive lime and scale buildup. This buildup on the tank walls, water valves, and heater element will vary dramatically, depending upon water quality. You should develop a cleaning and deliming schedule based on the apparent local water quality.

NOTE

To aid in removing scale from your merchandiser, National Vendors has a service kit available: part number 6400080. In addition, if your machine has the Everpure water inlet filter system option, a second kit (part number 6400086) is also available.

HOT DRINK SETUP/PROGRAMMING GUIDE

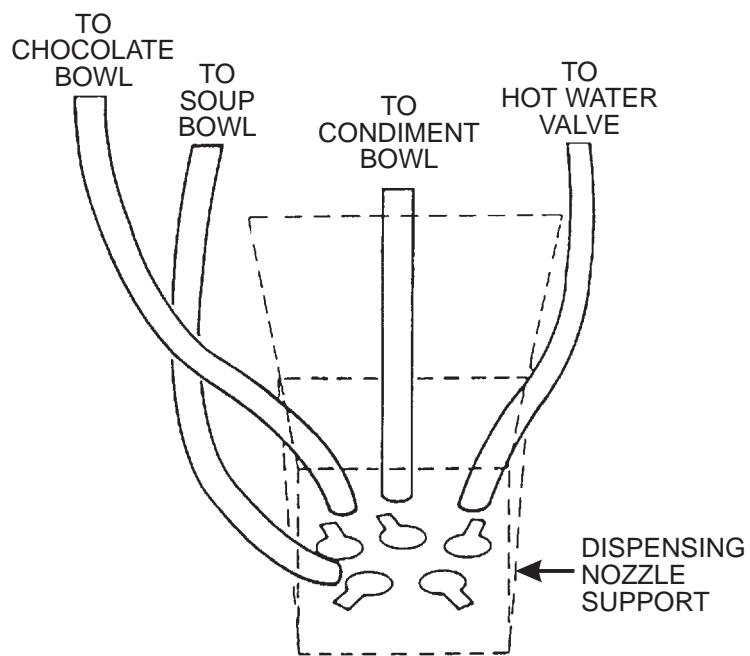

TUBE ROUTING DIAGRAM

THIS PAGE INTENTIONALLY LEFT BLANK

HOT DRINK SETUP/PROGRAMMING GUIDE

APPENDIX A. THE OPTIONAL PRINTER



The printer allows you to obtain a hard copy of data from the Hot Drink Center. This data includes:



- Machine ID number
- Time and date of printout
- Price of each selection
- Mug discount
- Dollar value of sales for all selections
- Sales counts for all selections

Printing is very simple:

1. Open the machine door and locate the printer cable. (You may need to open the monetary panel.)
2. Make sure the baud rate selected in the MACHINE CONFIGURATION function agrees with your printer's baud rate.
3. Connect the printer to the printer cable.
4. Turn the printer power ON.
5. The display shows *PRINTER*. You are now in the printer mode.

NOTE

Pressing  causes you to leave the printer mode. To reenter printer mode, press  while the printer is connected and turned on.

6. To print all prices, press . The printer begins printing. the machine display scrolls "◆◆" until the data has been downloaded, then it returns to *PRINTER*. The printer may continue printing for a while longer.
7. To print product configuration, press . The printer begins printing. the machine display scrolls "◆◆" until the data has been downloaded, then it returns to *PRINTER*. The printer may continue printing for a while longer.
8. To print sales information, press . To customize your printout, refer to the MACHINE CONFIGURATION function. The printer begins printing. the machine display scrolls "★★" until the data has been downloaded, then it returns to *PRINTER*. The printer may continue printing for a while longer.
9. When the printer is unplugged or turned off, the machine display will once again show the normal standby message.

THIS PAGE INTENTIONALLY LEFT BLANK

APPENDIX B. THE INFRARED MUG/CUP SENSOR

The infrared mug/cup sensor can sense the presence of a mug or cup without using moving parts.

Indicator light

The sensor is equipped with an indicator light. This light will help you get the best results from the infrared mug/cup sensor.

Under these conditions:

- Machine door open
- Cup station in place
- No cup in the station

The indicator light should be off. If it is on, it is indicating improper cup station alignment or excessive sensor sensitivity.

Under these conditions:

- Machine door closed
- Cup station in place
- No cup in the station

Press any letter on the selection switch panel, for example, **A**. Only the letter **A** should be showing in the message display. If "*A MUG*" is displayed, it indicates one or more of the following:

- Improper cup station alignment
- Excessive sensitivity (the sensor is sensing the delivery door)
- Cup station lens is not clean

Cleaning

As indicated in the Sanitation section, you should remove the cup station to clean it. Pay particular attention to the dark colored infrared mug/cup sensor lens, which is part of the cup station. If it is not thoroughly cleaned, the sensor will not work properly.

CAUTION

Do not get liquid inside the sensor unit.

Cleaning the infrared mug/cup sensor unit itself is not usually necessary. If it does require cleaning, just wipe it with a damp cloth.

HOT DRINK SETUP/PROGRAMMING GUIDE

Calibration

1. Remove the plastic cap in the rear of the sensing unit, exposing the potentiometer adjusting screw, as shown in figure B1.
2. Turn the screw clockwise to increase sensitivity of cup detection, or counterclockwise to decrease sensitivity.
3. Calibrate the sensor:

CAUTION

Do not adjust sensitivity too far, or unreliable sensing could result.

- a. Using a piece of **WHITE** poster board or heavy cardboard, make a 5" x 5-5/8" target.

NOTE

IT IS VERY IMPORTANT THAT THIS MATERIAL BE WHITE.

- b. Place the target in the cup station just beyond the cup deflectors (see figure C-2). The target should be standing vertically; not tilted forward or backward.
 - c. With the target in place, turn the adjusting screw **clockwise** very slowly until the indicator just turns ON.
 - d. Turn the adjusting screw **counterclockwise** very slowly until the indicator just turns OFF.
4. Replace the plastic cap.
 5. Insert a mug into the cup station in the vending position and check to see that the red indicator light is ON.

This calibration will be adequate for most cups or mugs. In some cases, a slightly more sensitive setting is needed if the cup or mug is a dark color.

VIEWING REAR OF SENSOR ASSEMBLY

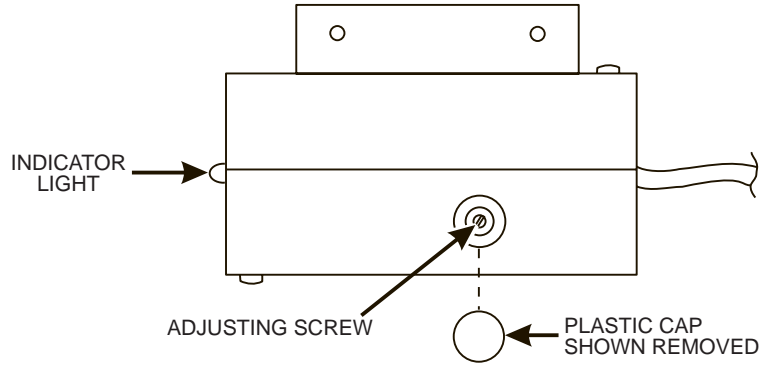

Figure B1

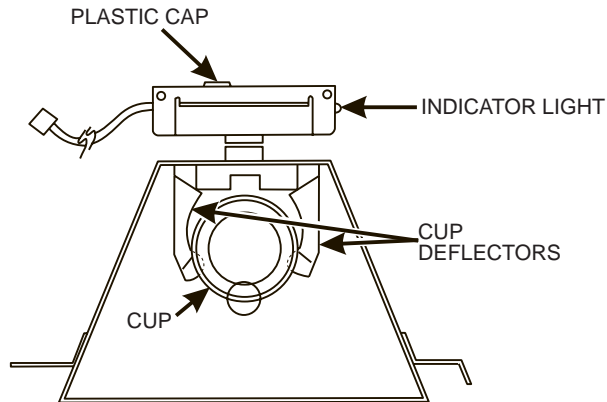

Figure B2

THIS PAGE INTENTIONALLY LEFT BLANK

APPENDIX C. DEX/UCS INTERFACE OPERATION

Connect your portable data collection device (PDCD) to the harness hanging inside the monetary door, and operate it per its instructions.

SELECT DATA TRANSFER METHOD:

1. Press . The display shows: *ENTER CODE*. You must enter the four-digit supervisor code within 6 seconds to gain access.

NOTE

A new machine has a factory-set supervisor code of 0000.

When you have entered the right code, you will hear two beeps and see *SUPERVISOR* in the display.

2. Press  until the display shows *DEX.CLR ON* or *DEX.CLR OFF*.

DEX.CLR ON = Data will be cleared after collection is complete.

DEX.CLR OFF = Data will remain in merchandiser memory after collection is complete.

3. Press  to switch between the two options.

4. Press  to exit.

This procedure does not need to be repeated unless you desire to change the data transfer option. However, it might be prudent to check the setting prior to download to ensure unintentional clearing of data.

DOWNLOAD DATA:

1. Press . The display shows *DEX.MODE* while data is being transferred.

THIS PAGE INTENTIONALLY LEFT BLANK

APPENDIX D. MODIFY CANISTER TO VEND 12 OZ. CUPS

Proceed as follows:

1. Remove all cups, then remove the turret center and turret base assembly from the canister.
2. Break off all 8 tabs on the bottom of the turret base as shown.

NOTE

You will no longer be able to vend smaller cups from this canister! To return to vending smaller cups you must replace the modified turret base with an original turret base (part number 6233048) from National Vendors Parts Department.

3. Replace the turret center and turret base in the canister and load cups.
4. Drop a cup. If it drops properly, you are finished with the procedure, if not, continue with step 5.
5. Remove all cups, then remove the canister from the cup mechanism assembly.
6. Remove the funnel, replace the canister, and reload cups.
7. Drop a cup. If it drops properly, you are finished with the procedure, if not, continue with step 8.
8. Order a 5 oz/18oz cup ring (part number 6233120) from National Vendors Parts Department.

APPENDIX D. MODIFY CANISTER TO VEND 12 OZ. CUPS

HOT DRINK SETUP/PROGRAMMING GUIDE

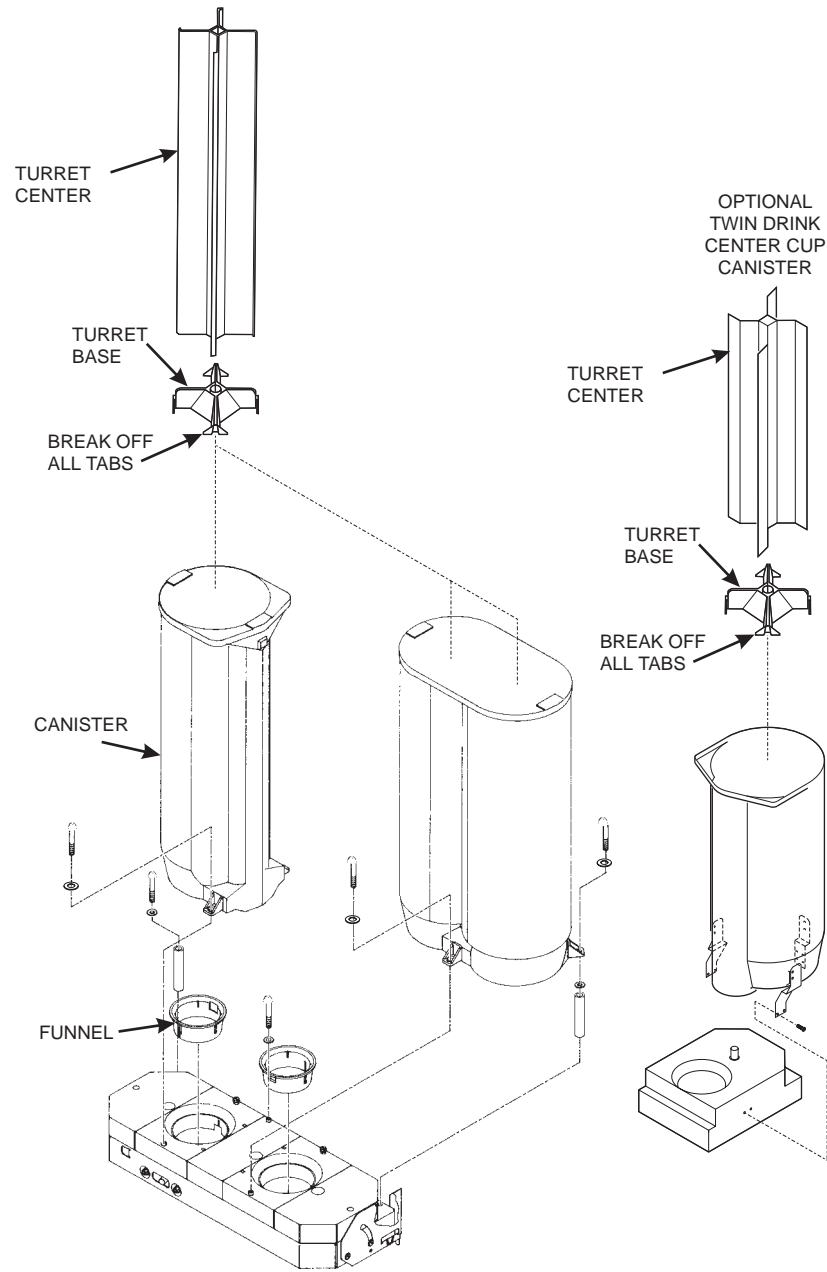

APPENDIX E. CLEAN THE HOT WATER TANK

Some smell and/or taste problems may occur in new machines. Follow this procedure to clean the hot water tank if you experience problems:

1. If the machine is in service, remove power from the machine.
2. Dissolve 1 tablespoon of common baking soda in a cup of water.

WARNING

The water tank may be HOT. Be careful when working on the tank.





3. Loosen or remove the hot water tank lid and pour the baking soda solution into the tank.
4. Apply power to the machine.
5. If the tank is not full, fill it.
6. Allow the tank to reach its operating temperature.
7. Leave the solution in the tank for ***AT LEAST*** ½ hour. If possible, leave the solution in the tank for 1 hour.
8. Drain the tank.
9. Refill the tank, then drain again.
10. Refill the tank and put the machine back into service.

THIS PAGE INTENTIONALLY LEFT BLANK

APPENDIX F. THE FREE VEND KEYSWITCH OPTION

The free vend keyswitch allows someone to set up free vending without needing to open the door.

It is a good idea to establish a free vend code. This will prevent an unauthorized person from setting the machine to free vend, even if they have a key.

1. Press . Enter your 4-digit supervisor code. Press .
2. Press  again, then press  until the display shows *FREE XXXX*. Enter a 4-digit free vend code.

NOTE

To keep the user from having to enter a code, you can enter *0000* as your code. See the steps below for details.

3. Press  until you have left the function.

USING THE FREE VEND KEY SWITCH:

If you have set your freevend option to *FREE W/KEY*:

1. Place your key in the free vend keyswitch and turn it to the right. (If the keyswitch is already turned to the right, turn it to the left, then back to the right.) The display shows: *ENTER CODE*.

NOTE

If your freevend code is set to *0000*, you will not see this display. Skip to step 3.

2. Enter your 4-digit freevend code. If you do this successfully within 6 seconds, you will hear two beeps, and the display shows: *UNLOCKED*.
3. The display shows *NO MONEY REQUIRED* (or whatever custom message you set up for the freevend period). Remove your key. All vends are free until the keyswitch is turned to the left again.
4. To take the machine off free vend, insert your key, turn the keyswitch to the left, and remove the key.

If you have set your freevend option to *FREE OFF* or *FREE ALL*:

1. If the freevend key is turned to the right, the machine will go out of service.

THIS PAGE INTENTIONALLY LEFT BLANK

WARRANTY STATEMENT

LIMITED WARRANTY. Subject to the limitations specified herein, this merchandiser is warranted for one (1) year against defective parts and workmanship. Any part or parts which are proven to be defective within one (1) year of the date of shipment will be repaired or replaced free of charge when the defective part is returned, with transportation charges prepaid, to the destination designated by CRANE MERCHANDISING SYSTEMS Warranty Department.

Refrigeration system's are warranted for (2) years against defective parts and workmanship. Any part or parts of the refrigeration system which are proven to be defective within (2) years of the date of shipment of the merchandiser will be repaired or replaced free of charge when the defective part(s) is returned, with transportation charges prepaid, to the destination designated by the Crane Merchandising Systems Warranty Department. Any part or parts that are proven to be free from defect will be assessed a diagnostic charge. This diagnostic charge will be added to the price of any replacement unit which might have been sent as an advanced replacement, as well as any shipping and handling fees that may have accrued as a result of shipping the original refrigeration unit. The charges will be the sole responsibility of the original purchaser.

This warranty does not include any cost of service rendered or repairs made by customer or it's agents on Merchandiser, or parts, unless authorization to incur such expense has been given in writing by CRANE MERCHANDISING SYSTEMS prior to incurring such expense. This warranty does not cover labor and service charges performed by CRANE MERCHANDISING SYSTEMS service technicians. Customer shall pay all labor costs with respect to warranty repairs.

This warranty does not apply to A) electrical components, wiring, or circuits and/or for all mechanical parts or assemblies damaged as a result of operating the Merchandiser at other than the design voltage and frequency specified on the Electrical Rating Tag, or B) in event of vandalism, fire or negligence, or C) incandescent lamps, neon lamps, fluorescent lamps, ballasts, starters or other expendable items or D) when other manufactured components are installed in Crane Merchandising Systems Merchandisers.

Replacement parts sold by CRANE MERCHANDISING SYSTEMS as After Market shall be covered for three months from the date shown on the parts invoice. Purchaser must obtain prior RETURN AUTHORIZATION for return of all parts, following guidelines given by Crane Merchandising Systems

New, unused parts purchased as AFTER MARKET, can be returned within 30 days from date of parts invoice, with prior authorization from CRANE MERCHANDISING SYSTEMS. **(Continued)**

WARRANTY STATEMENT

CRANE'S LIABILITY FOR ANY AND ALL LOSSES AND DAMAGES TO CUSTOMERS RESULTING FROM ANY CAUSE WHATSOEVER INCLUDING CRANE'S NEGLIGENCE, ALLEGED DAMAGE OR DEFECTIVE GOODS, IRRESPECTIVE OF WHETHER SUCH DEFECTS ARE DISCOVERABLE OR LATENT, SHALL IN NO EVENT EXCEED THE REPAIR OR REPLACEMENT OF DEFECTIVE OR DAMAGED GOODS OR, AT THE ELECTION OF CRANE, THE PURCHASE PRICE OF THE PARTICULAR GOODS WITH RESPECT TO WHICH LOSSES OR DAMAGES ARE CLAIMED. CRANE RESERVES THE RIGHT TO REPLACE OR REPAIR DEFECTIVE OR DAMAGED GOODS WITH REMANUFACTURED PARTS OR MACHINES.

THIS WARRANTY IS IN LIEU OF ALL OTHER WARRANTIES EXPRESS OR IMPLIED, INCLUDING WITHOUT LIMITATION, WARRANTIES OF MERCHANTABILITY OR FITNESS FOR A PARTICULAR PURPOSE. CRANE MERCHANDISING SYSTEMS SHALL NOT BE RESPONSIBLE FOR CONSEQUENTIAL OR PUNITIVE DAMAGES. CRANE MERCHANDISING SYSTEMS NEITHER ASSUMES NOR AUTHORIZES ANY PERSON TO ASSUME FOR IT ANY OBLIGATION OR LIABILITY IN CONNECTION WITH THE SALE OF SAID EQUIPMENT OR ANY PART THEREOF.

**Crane Merchandising Systems
A CRANE CO. Company
12955 Enterprise Way
Bridgeton, MO 63044**

Free Manuals Download Website

<http://myh66.com>

<http://usermanuals.us>

<http://www.somanuals.com>

<http://www.4manuals.cc>

<http://www.manual-lib.com>

<http://www.404manual.com>

<http://www.luxmanual.com>

<http://aubethermostatmanual.com>

Golf course search by state

<http://golfingnear.com>

Email search by domain

<http://emailbydomain.com>

Auto manuals search

<http://auto.somanuals.com>

TV manuals search

<http://tv.somanuals.com>