

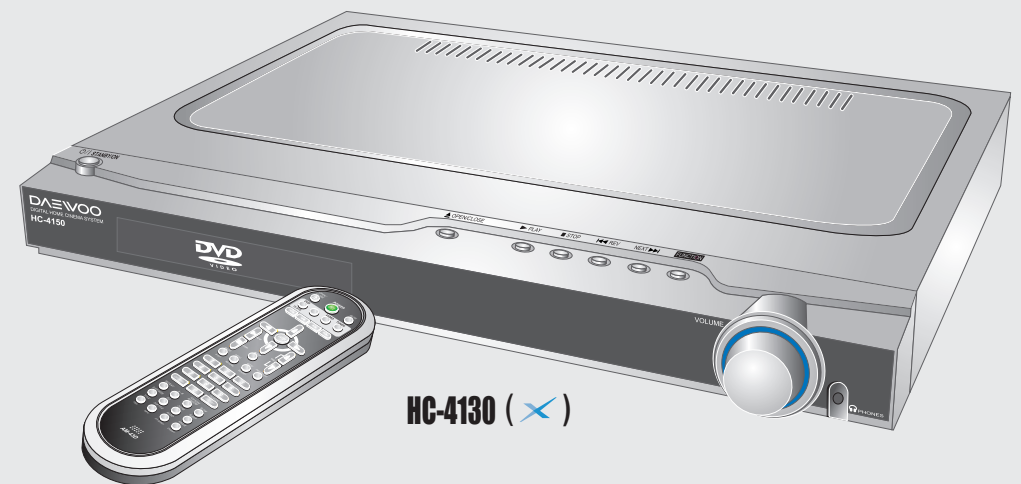



Instruction manual



Thank you for purchasing the Digital Home Cinema System.
Please read this manual thoroughly before making connections
and turning on the power.
Following the instructions in this manual will enable you to
obtain optimum performance and listening enjoyment from your
Digital Home Cinema System.
Please retain this manual for future reference.

Important Safeguards

WARNING : TO PREVENT FIRE OR ELECTRIC SHOCK, DO NOT EXPOSE THIS APPLIANCE TO RAIN OR MOISTURE.

| | |
|---|---|
|  | CAUTION RISK OF ELECTRIC SHOCKS DO NOT OPEN |
| CAUTION : TO REDUCE THE RISK OF ELECTRIC SHOCK, DO NOT REMOVE COVER(OR BACK). NO USER SERVICEABLE PARTS INSIDE. REFER SERVICING TO QUALIFIED SERVICE PERSONNEL. | |
|  | THIS SYMBOL IS INTENDED TO ALERT THE USER TO THE PRESENCE OF UNINSULATED "DANGEROUS VOLTAGE" WITHIN THE PRODUCT'S ENCLOSURE THAT MAY BE SUFFICIENT MAGNITUDE TO CONSTITUTE A RISK OF ELECTRIC SHOCK TO PERSONS. |
|  | THIS SYMBOL IS INTENDED TO ALERT THE USER TO THE PRESENCE OF IMPORTANT OPERATING AND MAINTENANCE(SERVICING) INSTRUCTIONS IN THE LITERATURE ACCOMPANYING THE APPLIANCE. |

| |
|--|
| CAUTION TO PREVENT ELECTRIC SHOCK, DO NOT USE THIS POLARIZED AC PLUG WITH AN EXTENSION CORD, RECEPTACLE OR OTHER OUTLET UNLESS THE BLADES CAN BE FULLY INSERTED TO PREVENT BLADE EXPOSURE. |
|--|

| |
|---|
| LASER SAFETY THIS UNIT EMPLOYS A LASER. ONLY QUALIFIED SERVICE PERSONNEL SHOULD REMOVE THE COVER OR ATTEMPT TO SERVICE THIS DEVICE DUE TO POSSIBLE EYE INJURY. CAUTION : USE OF ANY CONTROLS, ADJUSTMENTS, OR PROCEDURES OTHER THAN THOSE SPECIFIED HEREIN MAY RESULT IN HAZARDOUS RADIATION EXPOSURE. |
|---|

CAUTION : TO PREVENT ELECTRIC SHOCK, MATCH WIDE BLADE OF PLUG TO WIDE SLOT, FULLY INSERT.

ATTENTION : POUR EVITER LES CHOCs ELECTRIQUES, INTRODUIRE LA LAME LA PLUS LARGE DE LA FICHE DANS LA BORNE CORRESPONDANTE DE LA PRISE ET POUSSER JUSQU'AU FOND.

Important Safeguards

Important Safety Instructions

- All the safety and operating instructions should be read before the appliance is operated.
- The safety and operating instructions should be retained for future reference.
- All warnings on the appliance and in the operating instructions should be adhered to.
- All operating and use instructions should be followed.

PORTABLE CART WARNING

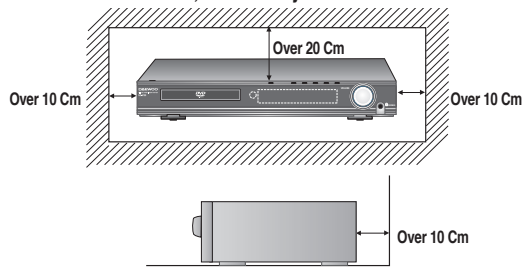

FIGURE 2

1. Water and Moisture - The appliance should not be used near water - for example, near a bathtub, washbowl, kitchen sink, laundry tub, in a wet basement, or near a swimming pool, and the like.
2. Carts and Stands - The appliance should be used only with a cart or stand that is recommended by the manufacturer.
3. An appliance and cart combination should be moved with care. Quick stops, excessive force, and uneven surfaces may cause the appliance and cart combination to overturn.
4. Wall or Ceiling Mounting - The appliance should be mounted to a wall or ceiling only as recommended by the manufacturer.
5. Ventilation - The appliance should be situated so that its location or position does not interfere with its proper ventilation. For example, the appliance should not be situated on a bed, sofa, rug, or similar surface that may block the ventilation openings; or, placed in a built-in installation, such as a bookcase or cabinet that may impede the flow of air through the ventilation openings.
6. Heat - The appliance should be situated away from heat sources such as radiators, heat registers, stoves, or other appliances (including amplifiers) that produce heat.
7. Power Sources - The appliance should be connected to a power supply only of the type described in the operating instructions or as marked on the appliance.
8. Grounding or Polarization - The precautions that should be taken so that the grounding or polarization means of an appliance is not defeated.
9. Power - Cord Protection - Power-supply cords should be routed so that they are not likely to be walked on or pinched by items placed upon or against them, paying particular attention to cords at plugs, convenience receptacles, and the point where they exit from the appliance.
10. Protective Attachment Plug - If the appliance is equipped with an attachment plug having overload protection. This is a safety feature. See Instruction Manual for replacement or resetting of protective device. If replacement of the plug is required, be sure the service technician has used a replacement plug specified by the manufacturer that has same overload protection as the original plug.
11. Cleaning - The appliance should be cleaned only as recommended by the manufacturer.
12. Power Lines - An outdoor antenna should be located away from power lines.
13. Nonuse Periods - The power cord of the appliance should be unplugged from the outlet when left unused for a long period of time.
14. Object and Liquid Entry - Care should be taken so that objects do not fall and liquids are not spilled into the enclosure through openings.
15. Damage Requiring Service - The appliance should be serviced by qualified service personnel when:
 - a) The power-supply cord or the plug has been damaged; or
 - b) Objects have fallen, or liquid has been spilled into the appliance; or
 - c) The appliance has been exposed to rain; or
 - d) The appliance does not appear to operate normally or exhibits a marked change in performance; or
 - e) The appliance has been dropped, or the enclosure damaged.
16. Servicing - The user should not attempt to service the appliance beyond that described in the operating instructions. All other servicing should be referred to qualified service personnel.

Precautions

1. **Warranty Claim**
You can find the serial number on the rear panel of this unit. In case of warranty claim, please report this number.
2. **Recording Copyright**
Recording of copyrighted material for other than personal use is illegal without permission of the copyright holder.
3. **AC Fuse**
The fuse is located inside the chassis and is not user-serviceable. If power does not come on, contact your authorized service center.
4. **Power**
WARNING
BEFORE PLUGGING IN THE UNIT FOR THE FIRST TIME, READ THE FOLLOWING SECTION CAREFULLY.
The voltage of the available power supply differs according to country or region. Be sure that the power supply voltage of the area where this unit will be used meets the required voltage (e.g., AC 230 V, 50 Hz or AC 120 V, 60 Hz) written on the rear panel.
Worldwide models are equipped with a voltage selector to conform to local power supplies. Be sure to set this switch to match the voltage of the power supply in your area before plugging in the unit.
5. **Do not touch this unit with wet hands**
Do not handle this unit or power cord when your hands are wet or damp. If water or any other liquid enters the case, take this unit to an authorized service center for inspection.
6. **Location of this unit**
Place this unit in a well-ventilated location.
Take special care to provide plenty of ventilation on all sides of this unit especially when it is placed in an audio rack. If ventilation is blocked, this unit may overheat and malfunction.



- Do not expose this unit to direct sunlight or heating units as this unit's internal temperature may rise and shorten the life of the pickup.
 - Avoid damp and dusty places and places directly affected by vibrations from the speakers. In particular, avoid placing the unit on or above one of the speakers.
 - Be sure this unit is placed in a horizontal position. Never place it on its side or on a slanted surface as it may malfunction.
 - When you place this machine near a TV, radio, or VCR, the playback picture may become poor and the sound may be distorted. In this case, place the machine away from the TV, radio, or VCR.
7. **Care**
From time to time you should wipe the front and rear panels and the cabinet with a soft cloth. For heavier dirt, dampen a soft cloth in a weak solution of mild detergent and water, wring it out dry, and wipe off the dirt. Following this, dry immediately with a clean cloth.
Do not use rough material, thinners, alcohol or other chemical solvents or cloths since these could damage the finish or remove the panel lettering.

8. **Notes on Handling**
 - Any changes or modifications in construction of this device which are not expressly approved by the party responsible for compliance could void the user's authority to operate the equipment.
 - When shipping the machine, use the original shipping carton and packing materials. For maximum protection, repack the unit as it was originally packed at the factory.
 - Do not use volatile liquids, such as insect spray, near the machine. Do not leave rubber or plastic products in contact with the machine for a long time. They will leave marks on the finish.
 - The top and rear panels of the machine may become warm after a long period of use. This is not a malfunction.
 - When the machine is not in use, be sure to remove the disc and turn off the power.
 - If you do not use the machine for a long period, the unit may not function properly in the future. Turn on and use the machine occasionally.
9. **To Obtain a Clear Picture**
The machine is a high technology, precision device. If the optical pick-up lens and disc drive parts are dirty or worn down, the picture quality becomes poor. To obtain a clear picture, we recommend regular inspection and maintenance (cleaning or parts replacement) every 1,000 hours of use depending on the operating environment.
For details, contact your nearest dealer.
10. **Notes on Moisture Condensation**
Moisture condensation damages the machine. Please read the following carefully.
Moisture condensation occurs, for example, when you pour a cold drink into a glass on a warm day. Drops of water form on the outside of the glass. In the same way, moisture may condense on the optical pick-up lens inside this unit, one of the most crucial internal parts of the machine.



- Moisture condensation occurs in the following cases.
 - When you bring the machine directly from a cold place to a warm place.
 - When you use the machine in a room where you just turned on the heater, or a place where the cold wind from the air conditioner directly hits the unit.
 - In summer, when you use the machine in a hot and humid place just after you move the unit from an air conditioned room.
 - When you use the machine in a humid place.



- Do not use the machine when moisture condensation may occur.
If you use the machine in such a situation, it may damage discs and internal parts. Remove the disc, connect the power cord of the machine to the wall outlet, turn on the machine, and leave it for two or three hours. After a few hours, the machine will have warmed up and evaporated any moisture. Keep the machine connected to the wall outlet and moisture condensation will seldom occur.

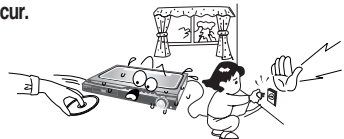

Table of Contents

| | |
|---|-----------|
| Important Safeguards/Precautions/Table of Contents..... | 2/3/4 |
| Getting Started | 6 |
| Features..... | 6 |
| Index to Parts and Controls..... | 7/8/9 |
| Preparing the Remote Controller, About This Instruction Manual, Note on Copyright | 10 |
| Notes on Discs..... | 11 |
| Connecting to a TV..... | 12 |
| Connecting to Audio/Video Equipment..... | 13 |
| Connecting Speakers, Positioning Speakers..... | 14 |
| Making Antenna Connections..... | 15 |
| Connecting the Power/Turning on the machine..... | 16 |
| TV Setup..... | 17 |
| Speaker Setup..... | 18/19 |
| Basic Operation | 20 |
| Playing DVD Videos/Video CDs/MP3 CD/Audio CDs..... | 20/21/22 |
| Locating a Specific Title/Chapter/Track by Disc Menu..... | 22 |
| Locating a Specific Title/Chapter/Track by Disc Menu, Locating a Specific Title/Chapter/Track/MP3 File/Location, Playing JPEG PHOTO File..... | 23/24 |
| Radio Listening..... | 25 |
| Receiving FM stations with RDS..... | 26 |
| Various Functions Common to all the Sources..... | 27 |
| Enjoying the Sound Effects..... | 28 |
| Advanced DVD/VIDEO CD/MP3/Audio CD Operation | 29 |
| Playing Repeatedly..... | 20 |
| Playing in Random Order/Zooming a Picture | 30 |
| Selecting the Camera Angle | 31 |
| Selecting the DIGEST..... | 32 |
| Selecting the Subtitles Included on the DVD | 33 |
| Selecting the Audio Language/Sound Included on the Disc..... | 34/35 |
| Customizing the Function Settings..... | 36/37/38 |
| Additional Operation | 39 |
| Recording Using the Connected Equipment..... | 39 |
| Others | 40 |
| Troubleshooting/Accessories..... | 40/41 |
| Specifications..... | 42 |
| Active Subwoofer System..... | 43 |

Features

◆ A/V Digital Receiver Features

- 50W RMS into 6 Ohm single channel driven, 1KHz with 10% THD(Front, Rear, Center) (refer to power table at 43 page)
- 80 W RMS into 4 Ohm subwoofer channel driven, 100Hz with 10% THD(subwoofer) (refer to power table at 43 page)
- DTS[®] *, Dolby[®] ** Digital & Dolby Pro Logic[™], Pro Logic II Decoders
- 7 DSP Listening Modes (DTS, Dolby Digital, Dolby Pro Logic, Dolby Pro Logic II Decoders, Stadium)
- 3 Equalizer Modes(Rock, Pop, Jazz) for Stereo source(Audio CD, Video CD, MP3 CD only)

◆ Player Features

- Video CD and CD Disc Playback Capability
- DivX File Playback Capability (Option : "X" Series only)
 - DivX 3.11 / 4.1 / 5.0 / 5.1 / 5.2 Capability
 - DivX AC3 5.1ch Capability
 - Subtitle Languages Capability
- JPEG File Playback Capability
- Digital Audio Output for MD or CD Recording
- Digital Audio Input(Option)
- On-screen Display (DVD only)
- 10-Bit Video D/A Conversion
- 3-Mode "Zoom-In" Function (Off, x1.5, x2)

- Search (DVD : title, chapter, time, VCD : time)
- Resume Play(DVD only)
- Random Playback (CD, MP3 only))
- 5-Mode Repeat (title, chapter, track, all tracks, A-B section)
- Slow Motion DVD Playback (SF 2x, 4x, 8x, 16x, SR 2x, 4x, 8x, 16x and normal speed)
- Fast Forward/Reverse (2x, 4x, 8x, 16x, 32x, 64x, 128x and normal speed)
- Multi Aspect Ratio (16:9 and 4:3)
- Multi Camera Angle
- Multi-Language Soundtrack Capability
- Multi Subtitle Languages Capability
- Parental Viewing Control
- 1 S-Video Output
- 2 Dedicated Line-Level Subwoofer Pre Out
- 1 A/V and 1 Audio Inputs (STEREO)
- Full Input/Output Video Tape Loops For Easy Dubbing
- Headphone Jack (3.5 ϕ)
- Sleep Timer (Remote Control)

◆ High Fidelity FM Tuner Features

- 40 FM Random Presets
- Auto Scan Preset
- FM Indoor Antenna

* Manufactured under license from Digital Theater Systems, Inc. US Pat. No.5,451,942 and other worldwide patents issues and pending, "DTS" and "DTS Digital Surround" are trademarks of Digital Theater Systems, Inc.© 1996 Digital theater Systems, Inc. All Rights reserved.

** Manufactured under license from Dolby Laboratories. "Dolby", "Pro Logic", and the double-DDD symbols are trademarks of Dolby Laboratories. Confidential Unpublished Works. ©1992-2004 Dolby Laboratories, Inc. All rights reserved.

Index to Parts and Controls

For operational instructions, refer to the page indicated in brackets.

◆ Front panel

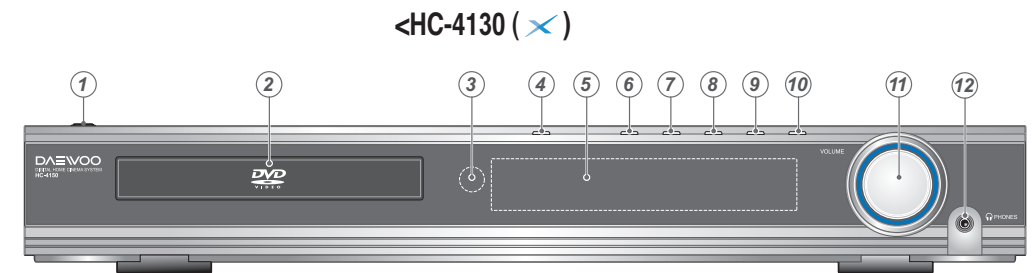

- | | |
|------------------------------------|---------------------------|
| 1. STANDBY/ON button with LED lamp | 7. STOP (■) button |
| 2. DISC TRAY | 8. PREV (◀◀) button |
| 3. Remote Control Sensor | 9. NEXT (▶▶) button |
| 4. OPEN/CLOSE (▲) button | 10. FUNCTION button |
| 5. Display | 11. MASTER VOLUME Control |
| 6. PLAY (▶) button | 12. PHONES jack |

◆ Display

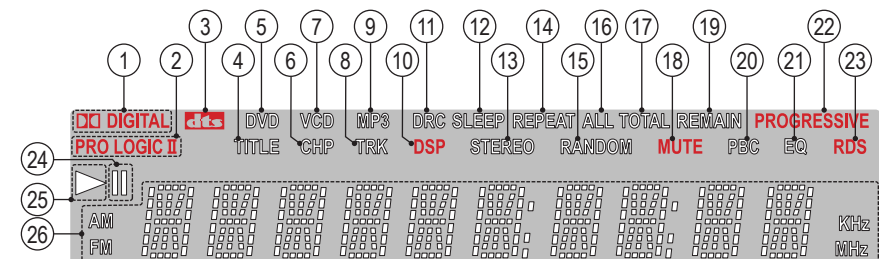

- | | |
|----------------------------|--|
| 1. DOLBY DIGITAL indicator | 14. REPEAT indicator |
| 2. Pro Logic II indicator | 15. RANDOM indicator |
| 3. DTS indicator | 16. ALL indicator |
| 4. TITLE indicator | 17. TOTAL indicator |
| 5. DVD indicator | 18. MUTE indicator |
| 6. CHAPTER indicator | 19. REMAIN indicator |
| 7. VCD indicator | 20. PBC(Playback Control) indicator |
| 8. TRACK indicator | 21. EQ indicator |
| 9. MP3 indicator | 22. PROGRESSIVE indicator |
| 10. DSP indicator | 23. RDS indicator |
| 11. DRC indicator | 24. PAUSE indicator |
| 12. SLEEP indicator | 25. PLAY indicator |
| 13. STEREO indicator | 26. Multi-Function Information Displaying Area |

Index to Parts and Controls

◆ Remote controller

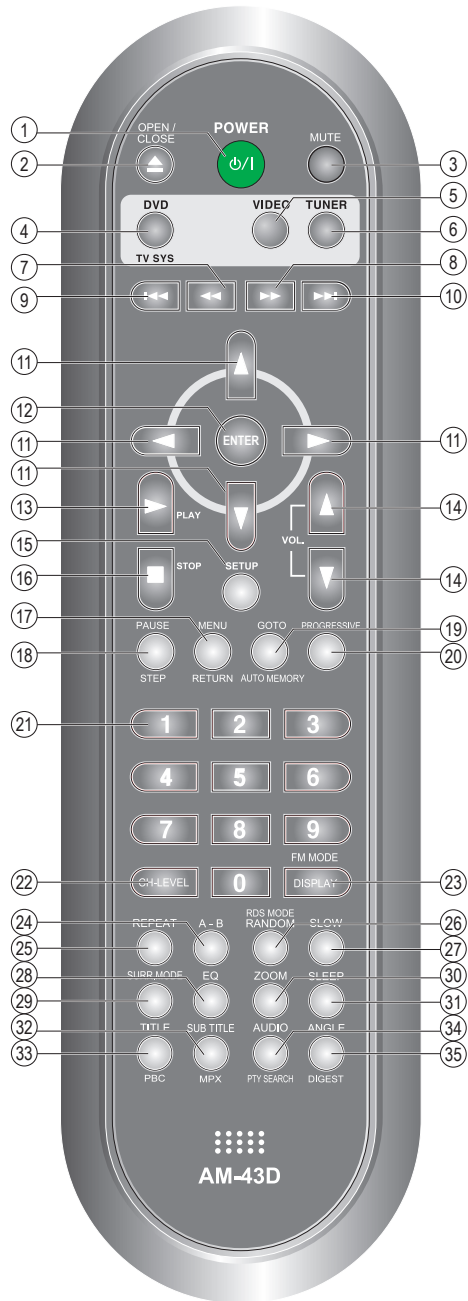

1. STANDBY/ON button
2. OPEN/CLOSE button
3. MUTE button
4. INPUT SELECTOR: DVD button/
TV SYSTEM(PAL/NTSC: DVD only) button
5. INPUT SELECTOR: VIDEO button
6. INPUT SELECTOR: TUNER button
7. FAST REVERSE(FR) (◀◀) button
8. FAST FORWARD(FF) (▶▶) button
9. SKIP PREV (◀◀) button
10. SKIP NEXT (▶▶) button
11. Direction (▲/▼/◀/▶) buttons
12. Enter button
13. PLAY (▶) button
14. VOLUME (▲/▼) buttons
15. SETUP button
16. STOP (■) button
17. MENU/RETURN button
18. PAUSE/STEP button
19. GO TO/AUTO MEMORY button
20. PROGRESSIVE button
21. Number buttons(0~9)
22. CH-LEVEL button
23. DISPLAY/FM MODE button
24. A-B REPEAT button
25. REPEAT button
26. RANDOM/RDS MODE button
27. SLOW button
28. EQ button
29. SURROUND MODE button
30. ZOOM button
31. SLEEP button
32. SUBTITLE/MPX button
33. TITLE/PBC button
34. AUDIO/PTY SEARCH button
35. ANGLE/DIGEST button

Index to Parts and Controls

◆ Rear Panel

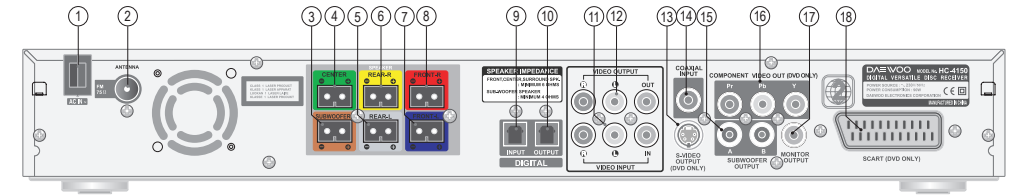

- | | |
|--|---|
| <ol style="list-style-type: none"> 1. Power cord 2. FM ANTENNA connector 3. SUBWOOFER SPEAKER connectors 4. CENTER SPEAKER connectors 5. REAR-L SPEAKER connectors 6. REAR-R SPEAKER connectors 7. FRONT-L SPEAKER connectors 8. FRONT-R SPEAKER connectors 9. DIGITAL INPUT jack | <ol style="list-style-type: none"> 10. DIGITAL OUTPUT jackj 11. VIDEO IN jacks 12. VIDEO OUT jacks 13. S VIDEO MONITOR OUT jack 14. COAXIAL INPUT jack 15. SUBWOOFER OUTPUT A/B connectors 16. COMPONENT VIDEO OUTPUT Y/Pb/Pr jacks (Optional) 17. MONITOR OUT jack 18. SCART jack |
|--|---|

Preparing the Remote Controller

Inserting the Batteries

1. Detach the battery cover.
2. Insert the batteries.
Be sure to match the + and - ends of the batteries with the diagram inside the battery compartment.
3. Attach the battery cover.

UM-4/ size AAA/ R03 x 2pcs

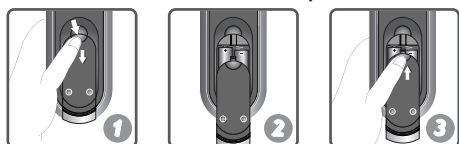

Notes

- Do not mix new batteries with old batteries or different kinds of batteries.
- To avoid corrosion, remove the batteries if the remote controller is not to be used for a long time.
- Remove dead batteries immediately to avoid damage from corrosion. If the remote controller does not operate smoothly, replace both the batteries at the same time.
- The life of the batteries supplied is about six months but this will vary depending on usage.

Using the Remote Controller

◆ Pointing the remote controller in the right direction

Point the remote controller toward the remote control sensor.

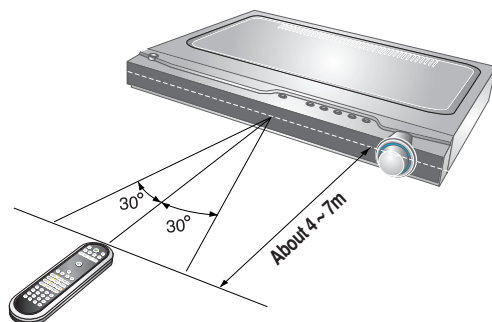

Notes

- Place the unit away from strong light such as direct sunlight or inverted fluorescent light which can prevent proper operation of the remote controller.
- Using another remote controller of the same type in the same room or using the unit near equipment which uses infrared rays may cause operational interference.
- Do not put any object such as a book on the remote controller. The buttons of the remote controller may be pressed by mistake and drain the batteries.
- Make sure the audio rack doors do not have colored glass. Placing the unit behind such doors may prevent proper remote controller operation.
- If there is any obstacle between the remote controller and the remote control sensor, the remote controller will not operate.

About This Instruction Manual

This instruction manual explains the basic procedures for operating of the machine. Some DVD videos are produced in a manner that allows specific or limited operation during playback. As such, the machine may not respond to all operating commands. Refer to instruction notes on discs.

A "⏸" mark may appear on the TV screen during operation.

The "⏸" mark means that the operation is not permitted by the machine or the disc.

Note on Copyright

It is forbidden by law to copy, broadcast, show, broadcast on cable, play in public, and rent copyrighted material without permission.

DVD videos are copy protected, and any recordings made from these discs will be distorted.

This product incorporates copyright protection technology that is protected by method claims of certain U.S. patents and other intellectual property rights owned by Macrovision Corporation and other rights owners. Use of this copyright protection technology must be authorized by Macrovision Corporation, and is intended for home and other limited viewing uses only unless otherwise authorized by Macrovision Corporation. Reverse engineering or disassembly is prohibited.

Notes on Discs

This section shows you how to handle, clean, and store discs.

On Handling Discs

- Do not touch the playback side of the disc.
- Do not attach paper or tape to discs.

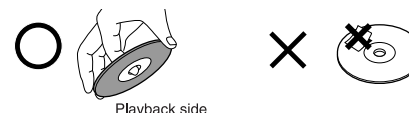

On Cleaning Discs

- Fingerprints and dust on the disc cause picture and sound deterioration. Wipe the disc from the center outwards with a soft cloth. Always keep the disc clean.



- If you cannot wipe off the dust with a soft cloth, wipe the disc lightly with a slightly moistened soft cloth and finish with a dry cloth.
- Do not use any type of solvent such as thinner, benzene, commercially available cleaners or antistatic spray for vinyl LPs. It may damage the disc.

On Storing Discs

- Do not store discs in a place subject to direct sunlight or near heat sources.
- Do not store discs in places subject to moisture and dust such as a bathroom or near a humidifier.
- Store discs vertically in a case. Stacking or placing objects on discs outside of their case may cause warping.

Note on Region Numbers

The region number are allocated to machine and software according to where they are sold. DVDs can be played on this machine if their region number is the same or includes the same number, or if the DVD is marked "ALL".

Confirm the region number for this machine before choosing discs. The number for machine is indicated on the rear panel.

On VIDEO CDs

This machine supports VIDEO CDs equipped with the PBC(Version 2.0) function. (PBC is the abbreviation of Playback Control.)

You can enjoy two playback variations depending on the type of disc.

- VIDEO CD not equipped with PBC function(Version 1.1)
Sound and movies can be played on this machine in the same way as an audio CD.

- VIDEO CD equipped with PBC function (Version 2.0)
In addition to operation of the VIDEO CD not equipped with the PBC function, you can enjoy playback with interactive software and with search function by using the menu displayed on the TV screen (Menu Playback). Some of the functions described in this Instruction Manual may not work with some discs.

Playable Discs

This machine can play back the following discs.

| Disc Type | Contents | Disc size | Maximum playback time |
|--|---|------------------|--|
| DVD videos with an suitable region number or ALL | Digital Audio + Digital Video (MPEG2) | 12 Cm | Approx. 240minutes (Single sided disc) |
| | | | Approx. 480minutes (Double sided disc) |
| | | 8 Cm | Approx. 80minutes (Single sided disc) |
| | | | Approx. 160minutes (Double sided disc) |
| VIDEO CDs (Version 1.0 / 1.1 / 2.0) or SVCD | Digital Audio + Digital Video (MPEG1) | 12 Cm | Approx. 74 minutes |
| | | 8 Cm | Approx. 20 minutes |
| Audio CDs (PCM or dts) | Digital Audio | 12 Cm | Approx. 74 minutes |
| | | 8 Cm (CD Single) | Approx. 20 minutes |
| CD-Rs, CD-RWs | Digital Video(MPEG1), Digital Audio or Only MP3 files | 12 Cm | Approx. 74 minutes |
| | | 8 Cm (CD Single) | Approx. 20 minutes |
| CD-ROMs | MP3, JPEG Files | 12 Cm | Approx. 640 MBytes |
| | | 8 Cm | Approx. 200 MBytes |

- You cannot play back discs other than those listed above.
 - DVD with an un suitable region number
 - DVD-Audio
 - DVD-ROM
 - DVD-RAM
 - VSD
 - CD-ROM
 - CDV
 - CVD
 - CD-G
 - SACD
 - DIVX Video Disc (playable in "X" series)

- This machine uses the PAL/NTSC color system, and cannot play back DVD videos recorded in any other color system (SECAM, etc.).
- Avoid using heart-shaped or octagonal discs. Playing irregularly shaped discs may damage the internal mechanism of the machine.
- Do not use discs on which adhesive from adhesive tape or a disc label (if it is a rental disc) remains. Otherwise, you may not be able to eject the discs or the machine may become inoperative.

Notes : playing MP-3 CD

The machine can play only single session maked CD-R/RW for ISO9660, Joliet format.

For other format, it may not play the discs.

Connecting to a TV

- ◆ Before connecting
- ◆ Refer also to the instruction manual of the TV.
- ◆ When you connect the machine to the TV, be sure to turn off the power and unplug both the units from the wall outlets before making any connections.
- ◆ Connect the machine to the TV directly. If you connect the machine to a VCR, TV/VCR combination, or video selector,

- the playback picture may be distorted as DVD videos are copy protected.
- ◆ Note that one video connection cable for monitor out is supplied.
- ◆ Automatically switched to the TV set A/V mode(DVD, Video)
- ◆ Do not change to Video Aspect Ratio.

Connecting to a TV without Color Difference Inputs

- ◆ 21-Pin SCART Cable(not included) to 21-pin SCART input terminal on TV
- ◆ SCART Specification : Composite and Component Video output(DVD, Video)Audio L/R Output(DVD only)

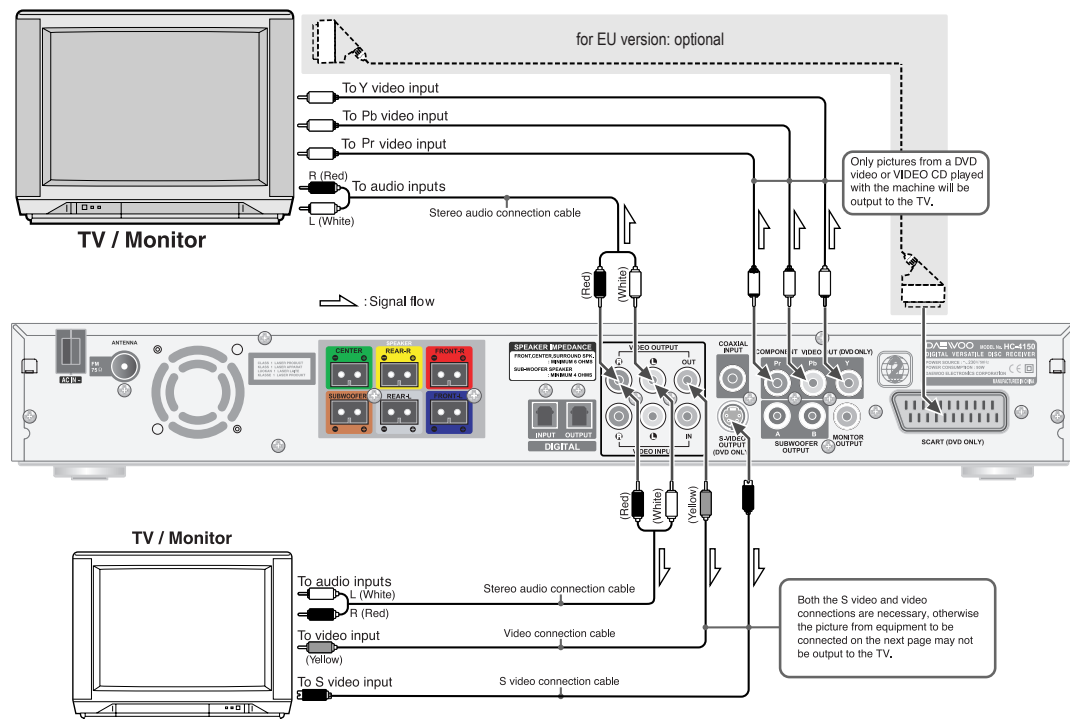

- ◆ If the TV or monitor is equipped with an S video input, make the S video connection in addition to the normal video connection. The S video connection will provide higher quality picture playback.

Connecting to a TV with Color Difference Inputs

If the TV or monitor is equipped with the color difference inputs, select the connection on the above. Connecting to these inputs allows you to enjoy higher quality picture playback compared to the above connection.

Notes

- ◆ Actual labels for color difference inputs may vary depending on the TV manufacturer (ex. Y/Cb/Cr, Y/R-Y/B-Y, Y/P_b/P_r or Component video).
- ◆ In some TVs or monitors, the color levels of the playback picture may be reduced slightly or the tint may change. In such a case, adjust the TV or monitor for optimum performance.

Caution

You may need to maximize the volume of the TV speaker(s) when you carry out steps in "Speaker Setup". Be sure to turn down the volume of the TV speaker(s) before changing the TV source input and using the TV speaker(s) as a normal TV speaker(s).

Connecting to Audio/Video Equipment

- ◆ Before connecting
- ◆ Refer also to the instruction manual of each component to be connected.
- ◆ When you connect the machine to audio/video equipment, be sure to turn off the power and unplug all the units from the wall outlets before making any connections.
- ◆ Connect the plugs securely.

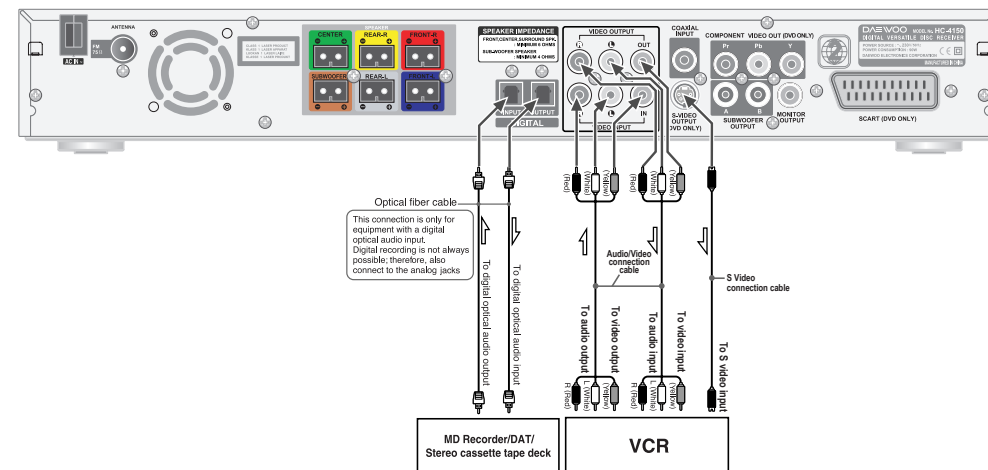

Connecting Speakers

- ◆ Before connecting
- This machine is designed to reproduce optimum sound quality when speakers with the specified impedance below are connected. Please check the following information and choose speakers with appropriate impedance for the connections.
 - Front speakers / Center speaker / Surround Speakers : 6 ohms min. per speaker
 - Woofer speaker : 6 ohm min
- To prevent damage to circuits, never short-circuit the positive (+) and negative (-) speaker wires.
- Do not connect the speaker cable to the L and R connectors at the same time and do not connect more than one speaker to the same speaker connectors.

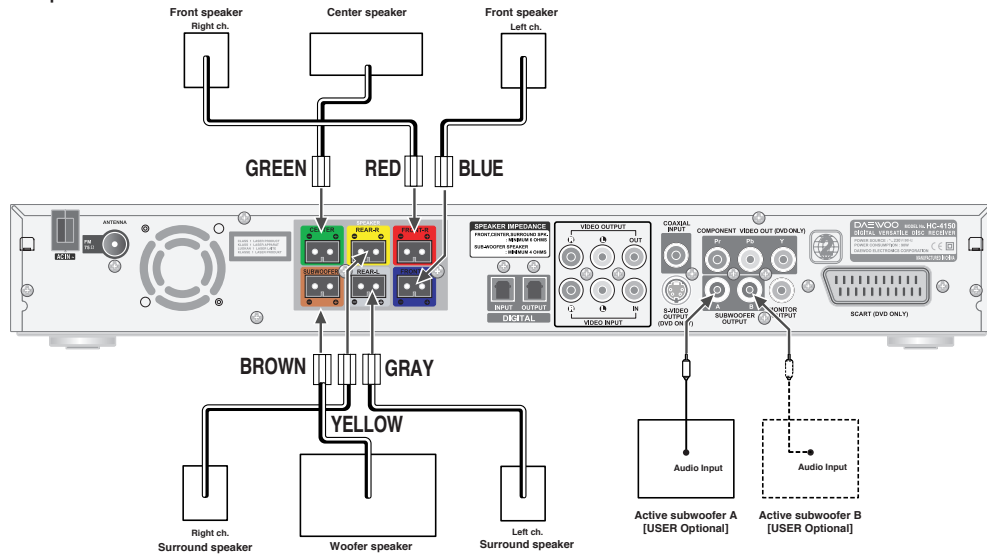

Positioning Speakers

Speaker placement plays an important role in the reproduction of Surround sound. The placement of the speakers varies depending on the size of the room and the wall coverings used in the room. The illustration below shows an example of a layout for standard speaker placement. Refer to this example when you position the speakers in order to experience the best of Surround sound.

◆ Standard speaker placement

For ideal Surround effects, all speakers should be installed.

Front

The left, right, and center speakers should face the seated listener and be placed at ear level. The center speaker reproduces a richer sound image by enhancing the perception of the sound's source and movement.

Surround

Place the left and right Surround speakers 1 meter (3 feet) above the listener's ear level and facing toward the sides of the room, making sure that the listener is within the speakers' dispersion angle. These speakers reproduce the feel of a moving sound while creating the sensation of being in the middle of the action.

Woofer

Install a subwoofer for powerful bass sounds. The placement of the subwoofer does not affect the final quality of the sound image too much, so you can install it wherever it is convenient.

*Note that installing too close to the TV may make a distortion the TV screen.

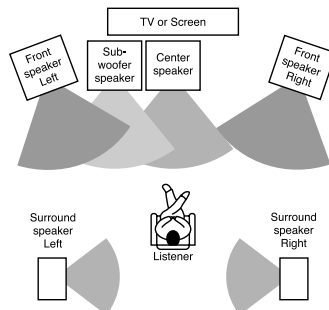

Making Antenna Connections

Connecting the Supplied FM Antennas

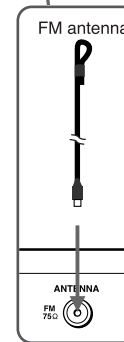
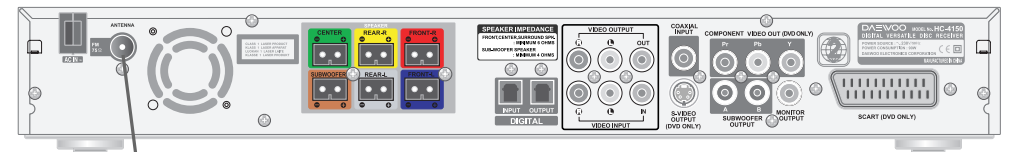

- ◆ Adjusting the position of the FM antenna
 - While listening to an FM program, extend the antenna and move it in various directions until the clearest signal is received, then secure the antenna with push pins in the position with the least distortion.

Connecting the FM outdoor Antenna(not supplied)

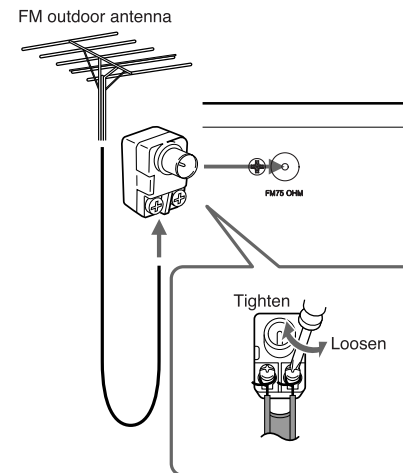

Connecting 300 ohm ribbon wire to a 75/300 ohm antenna adapter
Loosen the screws and wrap the wire around these screws. Then tighten the screws with a screw driver.

Connecting the Power/Turning on the machine

◆ Before connecting

- Turning on the machine may cause a momentary power surge, which might interfere with other electrical equipment such as computers. If this happens, use a wall outlet on a different circuit.



1. Connect the power cord to a wall outlet.
The machine enters standby mode.
The STANDBY indicator lights up.

2. Press STANDBY/ON on the machine or POWER on the remote controller.
The machine turns on.
The STANDBY indicator turns off.

Note

- To turn off the machine, press STANDBY/ON on the machine, or POWER on the remote controller.
The machine enters standby mode.

TV system setup

Selecting a TV Aspect

◆ Preparation

- Turn the TV on.
- Switch the video input mode of TV to suit the type of connection you have made (e.g., VIDEO)

1. Press SETUP button while the disc is stopped.
The setup main menu appears on the display.

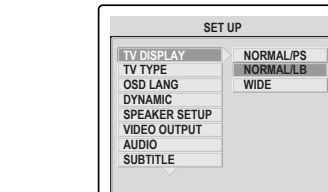

2. Press ▲/▼ button to select the "TV DISPLAY", then press ► to move.
The TV Display setting menu appears on the display.

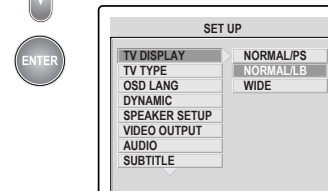

3. Press ▲/▼ button to select the required size, then press ENTER to confirm

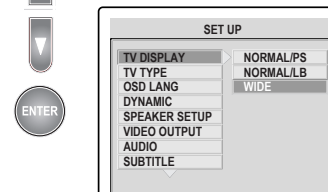

4. To stop the TV Aspect.
Press ◀ button to exit the TV Aspect setting.

5. To exit the SETUP.
Press SETUP button.

Selecting a Video Signal Type

1. Press ▲/▼ button to select the "TV TYPE" while the "SET UP" menu is displayed on the TV screen, then press ► button to move.

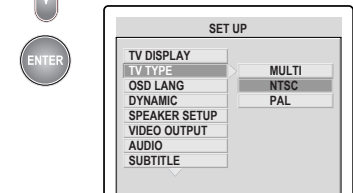

2. Press ▲/▼ button to select the required Signal type, then press ENTER to confirm.
The speaker setting menu appears on the display.

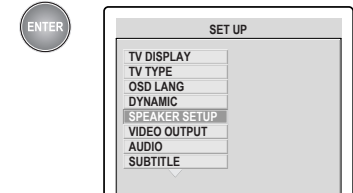

3. To stop the TV TYPE.
Press ◀ button to exit.

4. To exit the SETUP.
Press SETUP button.

Note : To select the Video Signal Type for directly.
Press DVD/TV SYS button repeatedly to select the required Signal type while disc tray opened.

Switching Scan Mode Type

1. Press OPEN/CLOSE.
The disc tray opens.

Press PROGRESSIVE button repeatedly to select the required Scan mode type (Interlace or Progressive).

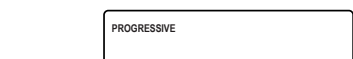

Speaker Setup

Before operating your machine, you need to set up the speaker configuration and the delay time from the listening position to each speaker.

Turning on/off the digital output

1. Press **SETUP** button while the disc is stopped.
The setup main menu appears on the display.

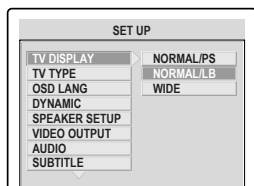

2. Press **▲/▼** button to select the "SPEAKER SETUP", then press **ENTER** to move the speaker setup menu.
The speaker setting menu appears on the display.

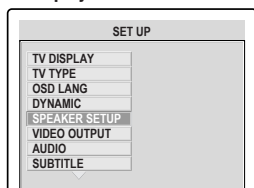

3. Press **▲/▼** button to select the "DIGITAL OUT", then press **▶** to confirm.

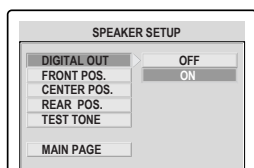

4. Press **▲/▼** button to select the "ON" or "OFF", then press **ENTER** to confirm.

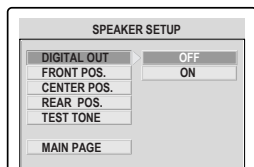

5. To exit the DIGITAL OUT on/off.
Press **◀** button.

4. To stop the SPEAKER SETUP
Press **▲/▼** button to select "MAIN PAGE", then press **ENTER** button.

6. To exit the SETUP.
Press **SETUP** button.

Adjusting Each Speaker's Position

If each speaker's position is disabled on the TV screen, select **DIGITAL OUT OFF**.

1. Press **▲/▼** button to select the "FRONT POS." while the "SPEAKER SETUP" menu is displayed on the TV screen, then press **▶** to confirm.
The front speaker position value appears on the display.

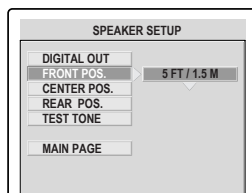

2. Press **▲/▼** button to select the speaker's distance, then press **ENTER** to confirm.
The speaker's distance can be adjusted between 5 FT / 2.5m and 30 FT / 9.2 m.

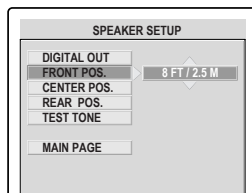

3. Repeat step 1~2 to adjust other speaker's position.

4. To stop the SPEAKER SETUP
Press **▲/▼** button to select "MAIN PAGE", then press **ENTER** button.

5. To exit the SETUP.
Press **SETUP** button.

Speaker Setup

Adjusting Each Speaker's Relative Volume Balance – Test Tone

If headphones are connected, remove the headphones.

1. Press **▲/▼** button to select the "TEST TONE" while the "SPEAKER SETUP" menu is displayed on the TV screen, then press **▶** button to move.

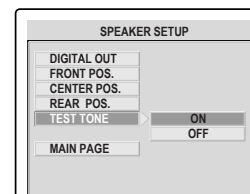

2. Press **▲/▼** button to select the "ON", then press **ENTER** to confirm.

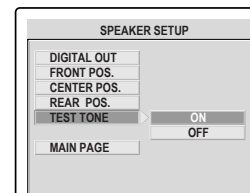

Each speaker emits the test tone (pink noise) in the following order:

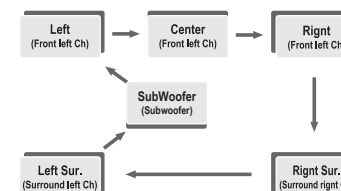

3. Press **CH.LEVEL** repeatedly to select the speaker, then press **▲/▼** to raise or lower the volume level until you have an equal volume balance with the other speakers at your listening position.
The volume level can be adjusted between -15 and +15dB.



4. To stop the test tone.
Press **SETUP** button to exit TEST TONE.

Playing DVD Videos / VIDEO CDs / MP3 CDs / Audio CDs

This section shows you the basics on how to play discs.

Before playing

- DVD Videos, VIDEO CDs, MP3 CDs, and audio CDs can be played with the machine. Do not play anything else.
- When playing DVD videos and VIDEO CDs, MP3 CDs turn on the TV and set the TV to the machine's input.

About the , ,  and  marks in the pages related to DVD video / DVD audio / VIDEO CD / MP3 CD / DivX CD / audio CD operation

 means "The function or title is related to DVD operation."

 means "The function or title is related to VIDEO CD operation."

 means "The function or title is related to MP3 CD operation."

 means "The function or title is related to audio CD, CD-R, CD-RW operation."

 Tip to obtain a higher quality picture

Occasionally, some picture noise not usually visible during a normal broadcast may appear on the TV screen while playing a DVD video because the high resolution pictures on these discs include a lot of information. While the amount of noise depends on the TV you use, you should generally adjust the TV to reduce sharpness when viewing DVD videos.

Basic Playback



1. Press OPEN/CLOSE.
The disc tray opens.

Note

If the machine is in standby mode, or the input source is other than DVD, when you press OPEN/CLOSE, it takes several seconds until the disc tray opens.

2. Place the disc on the disc tray.
Put the disc on the tray with the label side facing up.
There are two different disc sizes. Place the disc in the correct guide on the disc tray.

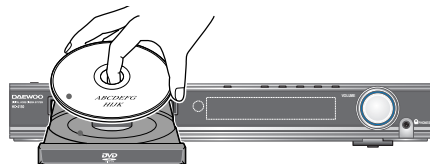

CAUTION



Keep your fingers well clear of the disc tray as it is closing. Neglecting to do so may cause serious personal injury.

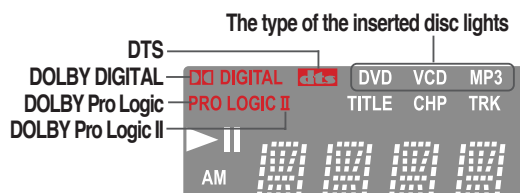

3. Press PLAY.
The disc tray is closed and playback starts.
If you press OPEN/CLOSE to close the tray after step 2, playback may automatically start depending on the disc.

One of the indicators which indicate the digital sound format of the playing source lights.



-  If a title menu appears on the TV screen
-  The DVD video has a title menu, or the VIDEO CD is equipped with the PBC (Playback Control) function. Follow steps 2 and 3 in "Locating a title using the title menu".



- Select desired folder 
1. Press /// repeatedly to select the folder and an MP3 file you want to play.



2. Press ENTER after selecting your favorite song.
When you know the title number, enter the MP3 title number using the numeric buttons on the remote controller and then press the ENTER button.



Press  button on remote controller to choose next title. Press  button for previous title.



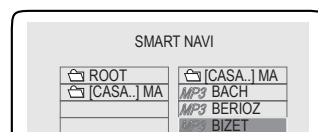

Note

- When an MP3 disc is loaded, MP3 menu screen is displayed automatically depending on MP3 disc's folder (directory) structure as shown below.
- Select MP3 title when stopped



Playing DVD Videos / VIDEO CDs / MP3 CDs / Audio CDs

 If a sound selection menu appears on the TV screen

See "Enjoying the Sound Effects" for details of the sound systems. Select the appropriate sound using ///, then press ENTER. For example, if you need to select either "DTS" or "Stereo", select "DTS" since the machine is able to reproduce DTS (Digital Theater System) Surround sound.

Note

- The location index memory will also be cleared when:
- The power cord is unplugged,
 - The machine has entered standby mode,
 - The disc tray is opened, and
 - The parental lock setting is changed or a disc menu language is selected.

Notes

- When you start playing a CD, the sound may not be reproduced briefly while the machine recognizes the sound system (DTS Surround or STEREO). If this happens, stop playback by pressing STOP, then press PLAY to restart playback. The sound will be reproduced from the beginning of the disc.
- Do not move the machine during playback. Doing so may damage the disc.
- Use OPEN/CLOSE on the remote controller or machine to open and close the disc tray. Do not touch the disc tray while it is moving.
- Do not press down on the disc tray or put any objects other than playable discs on the disc tray. Doing so may cause the machine to malfunction.
- In many instances, a menu screen appears when playback of a movie is complete. Prolonged display of an on-screen menu may damage your television set, permanently etching that image onto its screen. To avoid this, be sure to press STOP once the movie is complete.

To remove the disc



Press OPEN/CLOSE to open the disc tray. Remove the disc after the disc tray opens completely. After removing the disc, be sure to press the button again to close the tray.

To pause playback (still mode)



Press PAUSE during playback. To start playback, press PLAY.



To play frame by frame
Press the button repeatedly during pause. Each time you press the button the picture advances one frame.



To resume normal playback, press PLAY.

Note

The sound is muted during still mode and frame by frame playback.

To stop playback



Press STOP.
When you press PLAY to restart playback, playback starts from the location where you stopped playback because the location index is stored in memory. (This state is called PRESTOP: DVD only.)

Note

The location where playback resumes may vary depending on the disc or the stopped scene.

Resuming playback from the beginning
Press STOP again after stopping playback to clear the location index memory, then press PLAY to start playback.

 Playback starts from the beginning of the current title.

To start playback from the beginning of the DVD video, open and close the disc tray (press OPEN/CLOSE twice) then press PLAY to start playback.

 Playback starts from the beginning of the disc.



Slow searching

Press SLOW during playback. Each press of [SLOW] changes the slow-motion speed as follows:

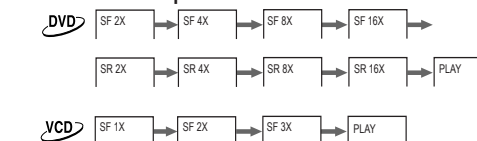

Notes

- The sound is muted during slow-motion playback.
- To resume normal playback, press PLAY or press SLOW repeatedly until "PLAY" displayed.

Playing DVD Videos / VIDEO CDs / MP3 CDs / Audio CDs

Fast Searching

Press ◀◀ (Fast Reverse) or ▶▶ (Fast Forward) during playback or pause. The playback speed becomes two times the normal speed. Each press of ◀◀ or ▶▶ changes the playback speed as follows:

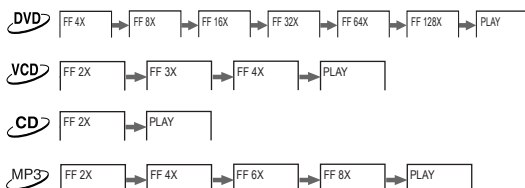

Notes

- No sound is reproduced and no subtitles appear during fast forward or reverse playback while playing back a DVD or a VIDEO CD, whereas the sound is reproduced while playing back an audio CD.
- The x2, x4, x8, x16, x32, x64 and x128 speeds are only approximate speeds.
- These speeds may vary slightly depending on disc.

To resume normal playback, press PLAY or press ◀◀ / ▶▶ repeatedly until "PLAY" is displayed.



Locating a Specific Title/Chapter/Track by Disc Menu

Normally, DVD videos are divided into titles, and the titles are subdivided into chapters. VIDEO CDs, and audio CDs are divided into tracks. Certain MP3 CDs are divided into MP3 files or folders, and the folders are subdivided into MP3 files or subfolders. You can quickly locate any specific title, chapter, track or MP3 file.

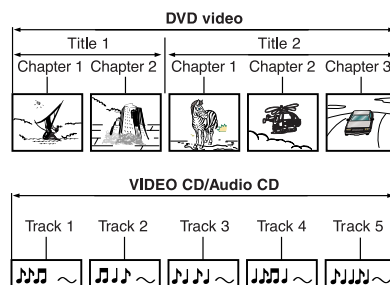

Locating a title using the title menu

If a DVD video contains a title menu, you can locate a specific title using the title menu function.

1. Press TITLE. (Depending on the DVD video, press MENU.) The title menu appears on the TV screen.

Example of a title menu.

e.g. DVD Title

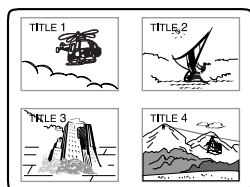

2. Press ▲/▼/◀/▶ to select the title, MP3 file or directory you want. If the titles in the title menu are assigned a number, you can also directly locate a specific title by entering its assigned number using the number buttons.



3. Press ENTER or PLAY. The machine starts playback from chapter 1 of the selected title



4. In case of MP3 CD, repeat steps 2 and 3 to select MP3 file. The machine start playback the selected MP3 file.

e.g. MP3 Title

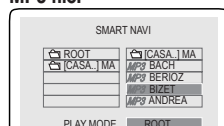

Locating a Specific Title/Chapter/Track by Disc Menu

Notes

- The instructions above describe basic procedures which may vary depending on the contents of the DVD video. If different instructions appear on the TV screen, follow those instructions.
- If you display the title menu during playback and press TITLE again without selecting any title, the machine usually resumes playback from the point where you first pressed TITLE. (There may be exceptional cases depending on the discs.)
- This method of locating a title is available only on a disc that contains a title menu.
- Instruction notes of discs may refer to the button that displays the title menu as "TOP MENU".

Locating a track using the PBC menu ^{VCD}

If a Video CD has "Playback Control" written on its disc or jacket, it means that particular scene or information can be selected for viewing interactively with the TV monitor using the PBC menu screen.



Press PBC to select [ON] To view the PBC menu screen when playing a PBC featured Video CD. [OFF] For playing a PBC featured Video CD without using the menu PBC screen.



Press the MENU to return to the preceding PBC menu. If there is no preceding menu (in case of the first menu), this function may not be executed.

Locating a Specific Title/Chapter/Track/MP3 File/Location

Locating a specific location by entering the time ^{DVD VCD CD}

You can locate a specific location by entering its corresponding time (hours, minutes, and seconds).



1. Press GO TO. Make sure that the number next to "TIME" is highlighted. (DVD: Press it twice)



2. Press the number button(s) to enter the title number for the desired time.

e.g. DVD Search

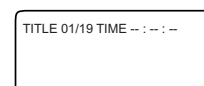

VCD Search

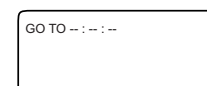

3. Press ENTER or PLAY. The machine starts playback from the selected time.

Notes

- Some discs may not respond to this procedure.
- Some scenes may not be located precisely.
- When VCD Stop, this method for accessing specific locations is available only within the current title of the VIDEO CD.

Locating a specific chapter ^{DVD}

If a DVD video contains the numbers corresponding to the titles and chapters, you can locate a specific chapter in a specific title directly by entering the numbers.



1. Press GO TO to select CHAPTER. Make sure that the number next to "CHAPTER" is highlighted.



2. Press the number button(s) to enter the chapter number for the desired chapter.

e.g. To select chapter 4

TITLE 01/24 CHAPTER 004/025



3. Press ENTER or PLAY. The machine starts playback from the selected chapter.



Locating a Specific Title/Chapter/Track/MP3 File/Location

Locating a specific title



1. Press GO TO to select TITLE.



2. Press ◀ to find the TITLE what you want.



3. Press the number button(s) to enter the chapter number for the desired chapter.

e.g. To select title 2

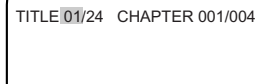

4. Press ENTER or PLAY.

The machine starts playback from the selected chapter in the selected title.



Notes

- Some title may not display chapter numbers.
- This location method is available only on a disc that contains the numbers corresponding to the titles and chapters.
- To cancel the entered title and chapter numbers, press STOP before pressing ENTER.

Playing JPEG PHOTO File

You can play JPEG file after selecting WITH MENU in the SETUP MENU.

If you select NO MENU, some photo files can not be played.

To enjoy smart navigation



Press ANGLE/DIGEST, when JPEG is played. Pictures are displayed in slide mode.

Press ANGLE/DIGEST, when JPEG is played. 9 Pictures are displayed all the same time.



If you want to select one picture, move the cursor pressing ▲/▼/◀/▶, then press ENTER or PLAY.



Notes : Play modes of MP3 and JPEG files.

- DISC : Play all the files in the disc then stop.
- DISC SCAN : Play the first 10 seconds of all files in the disc then stop.
- FOLDER : Play all the files in the folder then stop.
- REP ONE : Play a file repeatedly.
- SINGLE : Play a file then stop.
- SHUFFLE ON : Play all the files in the folder randomly one time then stop.
- RANDOM : Play the files in the folder randomly.

Locating a specific track directly

You can locate the desired track by entering the number.



1. Press the number button(s) to enter the track number for the desired track.
e.g. To select track 12



2. Press ENTER or PLAY.

The machine starts playback from the selected track.



Locating a specific chapter, track or MP3 file consecutively

You can locate consecutive chapters, tracks or MP3 files.



Press ◀◀ or ▶▶ (repeatedly) to select the chapter, track or MP3 file you wish to start playing

- Press ◀◀ once to start playback from the beginning of the current chapter, track or MP3 file.
- Press ◀◀ repeatedly to select the former chapters, tracks or files in reverse order.
- Press ▶▶ repeatedly to select the next chapter, track or MP3 file in order.

Radio Listening

There are two ways to select radio stations: one is manual tuning and the other is presetting radio stations then selecting the preset channels.

Tuning Stations



1. Press TUNER.



2. Press ◀◀ or ▶▶ to tune to the station. Station select mode will be changed from PRESET to Manual Tuning.



3. Press ◀◀ or ▶▶ to change the frequency. To find weak station too, press ◀◀ or ▶▶ repeatedly while tuning.

- If this button is held continuously for more than 0.5 seconds, the frequencies are scanned automatically. When a broadcast is received, scanning stops.

Notes : Tuning in a weak frequency (for FM stations)

- When you tune in a stereo FM station, the "STEREO" indicator lights up if the signal is normal. If the signal is weak, you may not be able to tune to the station. In this case, tune in as follows.



• Press FM MODE to select FM Mono.

The "STEREO" indicators turn off. At this time, the station will be in mono and interstation noise will be heard. Select the station to which you want to listen.

Programming Station Preset manually

- You can store up stations manually.



1. Tune in the radio station you wish to preset using ◀◀ or ▶▶.



2. Select the preset number.



3. Press PAUSE/STEP button.

Selecting Preset Stations

Before selecting preset stations, you need to preset the radio stations.



1. Press TUNER to switch the input source to the tuner. "FM" appears in the machine's display.



2. Press ◀◀ or ▶▶ repeatedly to select a station you want. The Channel and Frequency indicators appears in the machine's display.

Programming Station Preset Automatically

- You can store up to FM : 40 stations.
- You can preset radio stations only with the buttons on the remote controller.



Press TUNER to select FM.



Press AUTO MEMORY.

Preset no and Frequency displayed on the display.

Deleting Preset Stations



Keep press STOP for more 1 second at the station you want to delete.

Receiving FM stations with RDS(Europe only)

RDS(Radio Data System) is a broadcasting service which a growing number of FM stations are now providing. It allows the FM stations to send additional signals along with their regular program signals. For example, the stations send their station names and informations about what type of program they broadcast, such as sports or music, etc.

When tuned to an FM station which provides the RDS service, the RDS indicator lights up, the station frequency(and then the station name if sent)is displayed.

Not all FM stations provide RDS service, nor do all RDS stations provide same services. If in doubt, check with local radio stations for details on RDS services in your area.

This unit can use the following RDS service.

PS (Programme Service name) Identifies each station by a name.

RT (Radio Text) Allows the RDS station to send text messages that appear on the display of the unit.

PTY (Programme Type) Identifies the type of RDS programme. This allows you to locate a specific type name of program being broadcast.

Switching the display contents



To view RDS information on the display. Each time you press the button, the display changes to show the following informations. PS(Programme Service), PTY(Programme Type), RT(Radio Text) and Station frequency. Before the above information is displayed, "WAIT PS", "WAIT PTY" or "WAIT RT" may be appear on the display.

Searching for a desired programme by PTY codes

One of the advantages of the RDS service is that you can locate a particular kind of program by specifying the PTY codes.

The PTY Search function is applicable to preset stations only.

To search for a programme using the PTY codes, follow this procedure Using the remote control unit.



1. Press PTY SEARCH to search the PTY. "PTY" and "SELECT" appear alternately on the display.

2. Press or to select PTY. The display changes with each press of the button as shown below:

NEWS ↔ AFFAIRS ↔ INFO ↔ SPORT ↔
EDUCATE ↔ DRAMA ↔ CULTURE ↔
SCIENCE ↔ VARIED ↔ POP M ↔ ROCK M
↔ EASY M ↔ LIGHT M ↔ CLASSICS ↔
OTHER M ↔ WEATHER ↔ FINANCE ↔
CHILDREN ↔ SOCIAL A ↔ RELIGION ↔
PHONE IN ↔ TRAVEL ↔ LEISURE ↔ JAZZ
↔ COUNTRY ↔ NATIONAL ↔ OLDIES ↔
FOLK M ↔ DOCUMENT



Press the PTY SEARCH button again. While the search function is running, the selected program type and "SEARCH" is displayed alternately on the display. Once the station which is broadcasting the selected PTY(Program type) is located, searching will stop. Then the PTY will be indicated and the broadcast will commence. If a station broadcasting a selected PTY cannot be found, "NOT" and "FOUND" are displayed just one time alternately on the display. The unit will then return to the station to which it was tuned prior to the start of the PTY Search.

- RDS may not work correctly if the station to which you are tuned is not transmitting properly or if the signal strength is weak.
- RDS information have to be changed with only remote control unit.
- If no adjustment are made in PTY Select mode, "PTY" and "SELECT" will continuously appear on the display. Perform the next step while "PTY" and "SELECT" are being displayed.

Playing the Connected Source

This section shows you how to play the sources connected to the machine.

You may need to see "Connecting to a TV" on page 12 and "Connecting to Audio/Video Equipment" on page 13 while following the steps in this section.



1. Press the VIDEO buttons to select the input video source.

2. Start playing the selected source.

Various Functions Common to all the Sources

Adjusting the Volume

The volume of the front left, right, center, surround left and right, and subwoofer speakers will be adjusted at the same time.

When headphones are connected, you can adjust the volume of the sound



Press VOLUME ▲/▼ on the remote controller or turn VOLUME on the machine. The volume level increases or decreases.

Notes :

- To avoid damage to the speakers, do not keep operating the volume with distorted strong sound. Adjust the volume to the optimum listening level.

Listening Through Headphones

Connect the plug of the stereo headphones to the PHONES jack on the machine.

Notes :

- The speakers will not reproduce sound while headphones are connected.
- Sound will automatically be switched to STEREO after connecting the headphones to the PHONES jack.

Muting the Sound



Press MUTE. MUTE indicator in the machine's display is displayed. To restore the sound, press MUTE or Volume ▲/▼.

Using the Sleep Timer



Press SLEEP on the remote controller. "SLEEP 10" and SLEEP indicator appears on the machine's display, which means the machine will turn off and enter standby mode in 10 minutes.

Each time the button is pressed, the sleep time is changed to 10, 20, 30, 60, 90 minutes and OFF.

When Sleep Timer is on, system's display is dimmed.

◆ To cancel the Sleep Timer Press SLEEP repeatedly until the SLEEP indicator is disappeared.

Enjoying the Sound Effects

The surround sound of the machine lets you enjoy the presence of a movie theater or concert hall in your room. Before using any sound effect, make sure the Speaker Setup configurations have been set correctly. The speaker configuration is very important for the surround sound. See "Connecting Speakers" and "Positioning Speakers". Following are the sound systems the machine can reproduce.

DOLBY DIGITAL Surround and DTS (Digital Theater System) Surround

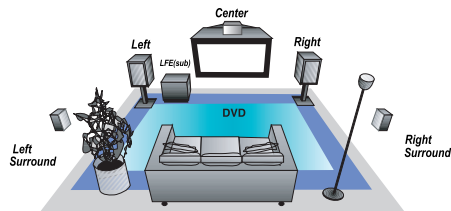

This 5.1-channel digital surround format lets you individually play five full-range (20Hz-20kHz) channels (left and right front, center, two surround channels) plus an LFE(Low Frequency Effect) channel for the low-range effect sound. It creates a realistic sound like that heard in theaters and concert halls.

DOLBY DIGITAL Surround

DVD videos that have the mark are recorded using this format.

DOLBY PRO LOGIC Surround

This surround format consists of four channels (left and right front, center, and monaural surround channel) and emphasizes the center channel. This format is very effective for panning music, conversation, and three-dimensional sound movement output from three front channels. It also simulates the atmosphere and surround effects of the sound reflected from the side and rear walls of the theater.

VHS, VHS Hi-Fi, video disc, and DVD videos that have the mark are recorded using this system.

DOLBY PRO LOGIC II Surround

Pro-logic II is new surround method to overcome the limit of Pro-logic. Pro-logic II can change stereo signal to 5.1 channels, beside Pro-logic can change stereo signal to 4.1 channels. Surround channel is separate from mono to stereo and has unlimited frequency band width.

DSP(Digital Signal Processor)

The machine automatically detects the sound system when DOLBY DIGITAL Surround, DTS Surround is played back. The sound system appears in the machine's display.

- Lights up when DTS Surround sound is reproduced.
- Digital Lights up when DOLBY DIGITAL Surround sound is reproduced.
- Pro Logic Lights up when DOLBY Pro Logic Surround sound is reproduced.
- Pro Logic II Lights up when DOLBY Pro Logic Surround sound is reproduced.
- DSP Lights up when DSP Surround sound is reproduced.



DTS Surround

DVD videos, video discs, and CDs that have the mark are recorded using this format.

To play back DTS Surround sound with connected equipment such as a video disc player, you must make the digital connection in addition to the above speaker configuration.

Notes : DTS Surround

- If you play a DTS Surround encoded disc with the DTS, or a DTS encoded disc using a digitally connected player, you may hear a noise for a short while until the DTS decoder of the machine recognizes the DTS encoded signal and starts operating. This is not a malfunction.
- If you play in fast reverse or fast forward, pause, or skip a chapter or track, while playing a DTS Surround source, noise may be heard. This is not a malfunction.
- Even when playback of the DTS Surround source stops and the DTS signal transmission ends, the machine remains in DTS mode and the DTS indicator remains lit. This is to prevent noise when you pause, fast forward, fast reverse, or skip a chapter or track of the playback source. Therefore, if the source switches from the DTS signal to a 2CH DOWN MIX(2 channel digital stereo) signal immediately, the 2CH DOWN MIX signal may not be played.
- Some CD players (if connected to the machine) and video disc players may be unable to play DTS Surround sources correctly even if you connect the player to the machine digitally. In such a case, the digital signals (such as the output level, sampling frequency, frequency response, etc.) processed by the player cannot be recognized as DTS data by the machine and you may hear noise instead of the proper sound.

While playing back sources other than DOLBY DIGITAL and DTS Surround sounds, you can select the desired DSP mode.



Press SURR. MODE on the remote controller repeatedly until the desired SURROUND MODE appears in the machine's display. The DSP indicator lights up when one of the SURROUND MODE is selected. Each press of the button changes the SURROUND MODE as follows:

Ex) STEREO → Pro Logic → MUSIC(Pro Logic II) → MOVIE(Pro Logic II) → STADIUM(DSP)

Playing Repeatedly

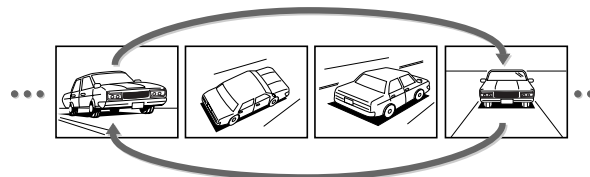

You can play a specific title, chapter, track or segment repeatedly (Title repeat, chapter/track repeat, all tracks and A-B repeat).



Repeating a Title, Chapter, or Track

You can play the same title, chapter, or track repeatedly (Title, chapter/ track repeat).



Press repeatedly REPEAT to select the repeat function.

When use DVD:

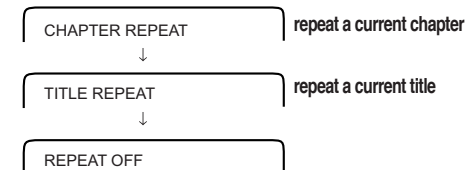

When use Video CD/Audio CD

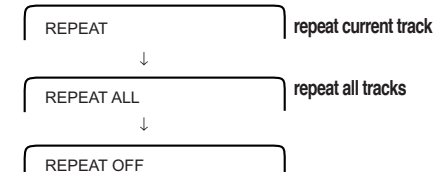

◆ To resume normal playback

Keep on pressing REPEAT button until Repeat off is displayed on the TV or disappear REPEAT indicator on the machine's display. The repeat function becomes cleared and the playing state changes to normal.

Notes

- Some discs may not permit repeat operation.
- Repeat play works only with discs for which the elapsed playing time appears in the machines display during playback.

Repeating a Specific Segment

You can play a specific segment repeatedly (A-B repeat).



1. Press A-B at the beginning of the segment (point A) you want to play repeatedly.

A - B SET A



2. Press A-B again at the end of the segment (point B). The machine automatically returns to point A and starts repeat playback of the selected segment (A-B).

A - B SET B

◆ To resume normal playback

Press A-B repeatedly until "A TO B CANCELLED" displayed on screen or disappear "REPEAT A-B" indicator in the machine's display.

Notes

- Some discs may not permit A-B repeat operation.
- You can play a specific segment only within the current title or track.
- You cannot set the A-B repeat function for segments that include multiple camera angles.
- There may be a slight difference between point A and the location where playback actually resumes depending on the disc.

Playing in Random Order

You can play tracks in random order (Random playback).

VCD CD

Playing Chapters or Tracks in Random Order

The machine automatically selects tracks in a VIDEO CD/AUDIO CD, and plays them randomly.



- 1 Press STOP button
Press the STOP button for normal VCD or Audio CD, PBC button for CVD, SVCD and VCD 2.0 with PBC to stop playing because this function is valid only for STOP state.



- 2 Press RANDOM button on remote controller
When the RANDOM button is pressed, SHUFFLE ON is displayed on the TV screen and the RANDOM indicator on the machine's display is turned on.

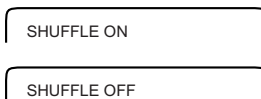

- 3 Press PLAY button
When the PLAY button is pressed, the shuffled track starts playing.



◆ To resume normal playback

press STOP to stop random playing and then press RANDOM button. When the RANDOM button is pressed, SHUFFLE OFF is displayed on TV and the RANDOM indicator on the machine's display is turned off.



Notes

- Some discs may not permit random playback operation.
- If you press ►► during random playback, the DVD Receiver goes to another title or track and continues random playback.

Zooming a Picture



You can zoom in on a picture. You can also shift the zoom point.

Zooming a Picture and Shifting the Zoom Point



1. Press ZOOM during normal or still playback.

If you press ZOOM repeatedly, the magnification level increases.

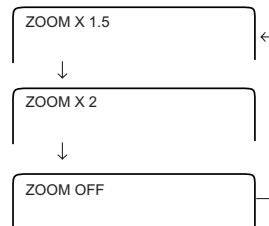

To shift the zoom point
Press ▲/▼/◀/▶.

Notes

- Some discs may not permit to zoom operation.
- During some scenes, the buttons may not work as described above.
- Zooming does not work on subtitles or menu screens included on DVD videos.
- During zoom playback, ▲/▼/◀/▶ does not work on menu screens included on DVD videos. If you want to view the menus, cancel zoom playback.
- The magnification level varies depending on the picture size you select.

◆ To resume normal playback



Press ZOOM repeatedly until "ZOOM OFF" display.

Selecting the Camera Angle

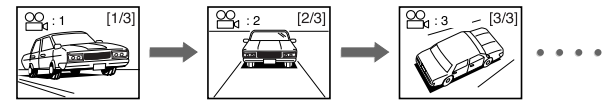

Some DVD discs may contain scenes, which have been shot simultaneously from a number of different angles. For these discs, the same scene can be viewed from each of these different angles using the ANGLE button. If the loaded disc supports multiple angles, you can see indicator on the machine's display and TV screen.

Changing the Camera Angle

If the scene was recorded from multiple angles, you can easily change the camera angle of the scene you are watching.



1. Press ANGLE while playing a scene recorded with multiple angles.
Press ANGLE while the angle icon is displayed.

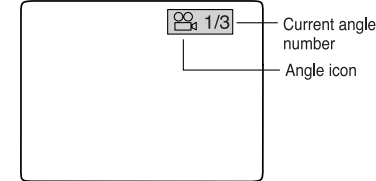

2. Press ANGLE or while the angle number is displayed on the TV screen.
Each time you press ANGLE, the camera angle changes.



◆ To turn off the angle number display

Press ANGLE repeatedly to select the Original Angle Number.



Selecting the Digest

VCD

This function helps speedy search to the desired track by displaying 9 different small screens per page showing information regarding the tracks recorded on the disc.



- 1. Press STOP button**
Press the STOP button for normal VCD or PBC button for CVD, SVCD and VCD 2.0 with PBC to stop playing because this function is valid only for the STOP state.



- 2. Press DIGEST button**
If the DIGEST button is pressed, 4 submenus are displayed on the TV screen as shown below.
Select the submenu, which you want, by pressing the appropriate number button and the ENTER button. If you don't want this function, press number 4 for exit.



Digest submenu for VCD

1. INTRO plays each track for 10 seconds (VCD only).
2. DISC shows digest screen based on the disc. It plays each track on the thumbnail screen for about 5 seconds (VCD only).
3. TRACK shows digest screen based on the track. It plays partitioned track on thumbnail screen for about 5 seconds (VCD only).
4. EXIT just exits digest function



- 3. When you choose INTRO**
All the tracks on the disc are played for 10 seconds if no key is pressed. After all the tracks are played, it stops and displays STOP on the TV.
- 4. When you choose DISC or TRACK**
Digest function will play and display in the small screen in the center. Each screen plays approximately five seconds while displaying a total of nine screens as shown in the figure.
Press NEXT button to see the next page and press PREV button to see the previous page.

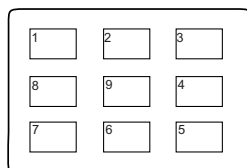

Digest - DISC

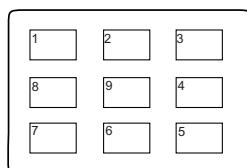

Digest - TRACK



- 5. Press the desired screen number**
If you press the desired number of small screen, it starts playing from the position where the small screen begins.

Selecting Subtitles Included on the DVD



You can display subtitles on the TV screen and select a subtitle language from those included on the DVD video.

Selecting a Subtitle Language DVD

You can select a subtitle language from those included on the DVD video and DivX file (DivX play is only for "X" series).



- 1. Press SUBTITLE during playback.**
The subtitle setting is displayed for about 3 seconds.

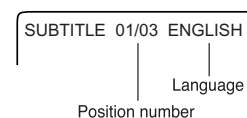

- 2. Press SUBTITLE.**
Each time you press SUBTITLE, the subtitle language changes to the next language included on the DVD video.

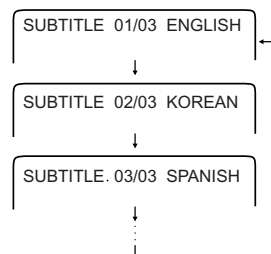

◆ To turn subtitles off

- During playback
1. Press SUBTITLE repeatedly until the "SUBTITLE OFF" displayed on the TV screen.



◆ Viewing a subtitle for DivX (Only for "X" series)

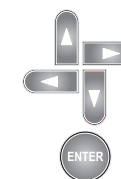

1. Before selecting a DivX move file, place cursor to folder that have a subtitle.
2. Select a proper subtitle file by cursor and then press ENTER button.
3. Lastly, select and play a DivX move file same as the above.

- Supportable format for DivX subtitle :
*.SML, *.SRT, *.SUB, *.TXT

Notes

- This function is a disc dependent. There are some DVD discs that prevent selecting subtitle even though the disc supports multiple subtitles. In this case, the subtitle should be selected via the disc menu.
- When you select a subtitle language which is not included on the disc, the machine plays the prior language programmed on the disc.
- During some scenes, the subtitles may not appear immediately after you change the subtitle language.

Notes

- Some DVD videos are set to display subtitles automatically, and you cannot turn them off even if you set the subtitle function to off.
- During some scenes, the subtitles may not appear immediately after you select "On".
- Some DVD videos will allow you to make subtitle selections and turn subtitles on or off only by using the disc menu.
- If you want to see subtitle against DivX file, you make sure either DivX move file must contain proper subtitle or both of them should be in same disc. ("X" series only)
- Some AVI files made of Windows Media format can't playback. ("X" series only)

Selecting the Audio Language/Sound Included on the Disc

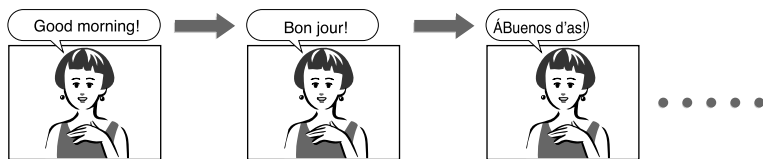

You can select a preferred audio language and sound system.

Selecting a Playback Audio Setting DVD

You can select the preferred audio language and sound system as a set from those included on the DVD video. This function lets you temporarily change the audio language which you selected as the automatic setting in the setting menu, and choose the sound system if the DVD video is recorded in more than one sound format.

- 1. Press AUDIO during playback.**
The audio setting is displayed for about 3 seconds.

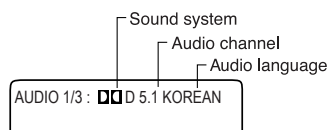

- 2. Press AUDIO.**
Each time you press AUDIO, the language and audio recording system set changes.

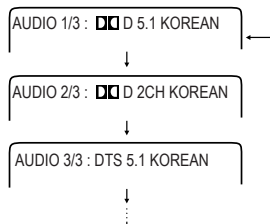

Note
Dolby Digital 5.1 Channel sound may be displayed as "[D] D 5.1."

◆ About recording systems

This machine uses the Dolby Digital, DTS, and PCM systems and cannot play DVD videos recorded in any other sound system.

Notes

- Some discs allow you to change audio selections only by using the disc menu. If this is the case, press MENU and choose the appropriate language from the selections in the disc menu.
- Some discs may have only one audio language and sound recording system set and you cannot change this selection.
- The "Audio Language" setting in the setting menu is for automatic selection of the audio language among those included on the DVD video when the DVD is inserted. Therefore, the selection in this section will not change the setting of "Audio Language" in the setting menu. (Occasionally, the audio language and sound system are selected by the disc.)

Selecting Sound Channels VCD

A Video CD may left and right channels which contain sounds or languages on each channel. You can switch these two channels to hear a preferred sound or language.

During playback, press MPX (repeatedly) to select the sound channel.

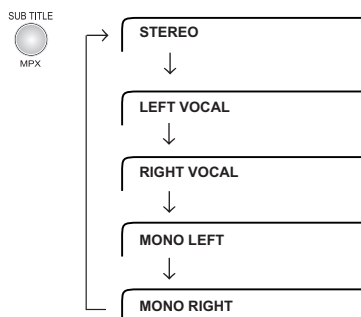

Using information on the On-Screen display

You can view information about a disc and its operational status on the TV screen.

Checking the Total Number of the Titles/Tracks, Current Title/Chapter/Track, Remaining and Elapsed Time, etc. DVD VCD MP3 CD



Press DISPLAY while the disc is stopped or playback. Each time you press DISPLAY, the on-screen display on the TV screen changes as follows.

In case of DVD video

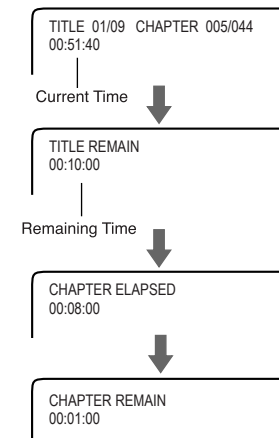

In case of VIDEO CD/AUDIO CD

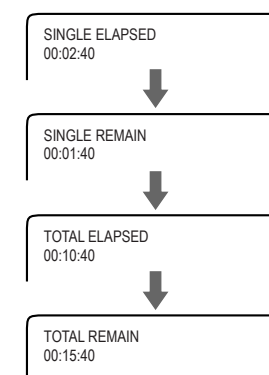

In case of MP3 CD

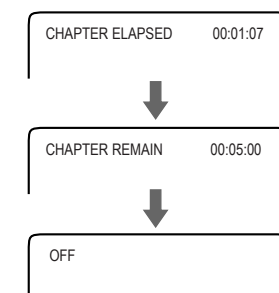

Customizing the Function Settings

When you insert a DVD Video, VIDEO CD, the various functions of the machine will be set (reset) according to the setting menu. You can customize this setting menu according to your preference.

Selecting a Setting

The setting menu asks you to select a setting category from among LANGUAGE, PICTURE, AUDIO, DISPLAY, and OPERATION.

Each selected setup menu will provide you with setting details.

SETUP MENU

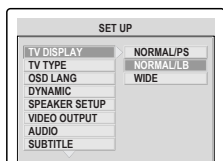

SPEAKER SETUP PAGE

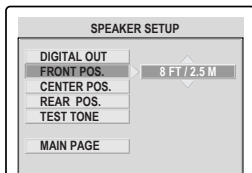

1. Press **SETUP**.
The on-screen display appears.
2. Press **▲/▼** to select the setup menu.
3. Press **ENTER** on the selected menu.
4. Press **▶** to move the setting item.
5. Press **▲/▼** to select the setting item.
In case of the password setup menu.
Press **▲/▼/◀/▶** and **ENTER** to set 4 digits password number.
6. Press **ENTER** on the selected item.
7. Press **◀** to select the setup menu.
8. To finish the setup, Press **SETUP** or select **MAIN PAGE**.
Repeat 1~6 Steps to select your desired setting.

Notes

- Preferences can only be selected/accessed in STOP mode.

PARENTAL LOCK (DVD only)

This function is to disable the playing of specified DVD that are unsuitable for children. As each disc has slightly different codes, please refer to the disc instruction. There are 8 levels. If the level is 8, the contents of the disc are suitable for adult. If the level is 1, the contents of the disc are suitable for child. If you didn't set a new password and level, there is no restriction playing discs. When you turn on this unit for the first time, setting the new password is recommended

PARENTAL

You can set the parental lock level what you want. Once selected, whenever you play a disc, the selected parental is compared to the level on the disc, if the level you selected is greater than the level of the disc, you may play the loaded disc. If not, you may not play the disc. To set appropriate parental level, do the following instruction.

1. If you move the cursor to **PARENTAL** using **▲/▼** button on MAIN PAGE, you can see the sub items of PARENTAL.

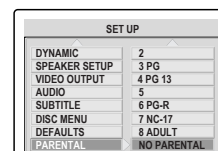

2. You can move to the level position by pressing the **▶** button. Move to the level what you want using **▲/▼** button, then select by pressing **ENTER** button.

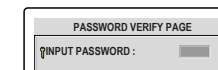

3. Input your password.
If it is the first time inputting password, the password is "0000".



4. The parental level will be changed by pressing the **ENTER** button.

PASSWORD

You can change the password for the parental lock. To change the current password to the new one, do the following instruction.

1. If you move the cursor to **PASSWORD** using **▲/▼** button on MAIN PAGE, you can see **CHANGE**.

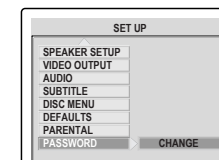

2. You can move to **CHANGE** by pressing the **▶** button. Press **ENTER** button.

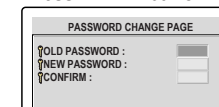

3. Input your current password on **OLD PASSWORD**.
Input the new password what you want to use from now on **NEW PASSWORD**.
Re-input the new password on **CONFIRM PWD**.
If it is the first time changing password, Input "0000" on **OLD PASSWORD**.

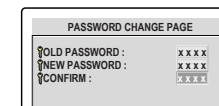

4. The password will be changed by pressing the **ENTER** button.

Customizing the Function Settings

Once the initial settings have been completed, the player can always be operated under the same conditions whenever the power is switched on. These settings are called SETUP data that are easily modified and stored using the SETUP menu. The SETUP menu includes the information for AUDIO and other system controls.

| SETUP MENU | ITEM and DESCRIPTIONS | |
|------------|--|---|
| TV DISPLAY | NORMAL/PS NORMAL/LB WIDE | <p>Set up TV aspect according to your TV set. If WIDE screen is supported on your TV, select WIDE. If your TV supports only 4:3, you may select both NORMAL/ PS (Pan & Scan) and NORMAL/LB (Letter Box).</p> <p>When using a wide screen TV (16:9 aspect ratio) Select WIDE in the TV ASPECT value.</p> <p>Discs may be recorded in more than one screen format. Following the chart below, make screen aspect adjustments in your wide screen TV according to the aspect ratio on the disc you are viewing.</p> <p>When using a standard TV (4:3 aspect ratio) Select NORMAL/LB (Letter Box) or NORMAL/PS (Pan & Scan) in the TV ASPECT value.</p> <p>Following the chart below, make screen aspect adjustments according to the aspect ratio on the disc you are viewing.</p> |
| TV TYPE | MULTI NTSC PAL | Set up TV type according to type supported by your TV or monitor. When you select MULTI, the output video type is dependent on the disc loaded. If the recorded video type is PAL then it outputs PAL. If NTSC then NTSC. |
| OSD LANG | ENGLISH GERMAN FRENCH DUTCH ITALIAN SPANISH | <p>This item is to select the language for On-Screen Display messages that will be displayed on the TV screen. When your desired language is selected, all OSD messages are displayed in the selected language.</p> <p>Note : Selecting languages in the SE UP can be changed / added/ deleted in accordance with region.</p> |
| DYNAMIC | FULL : 6/8 : 4/8 : 2/8 : OFF | <p>Dynamic Range Control. (Valid for Dolby Digital DVD disc)</p> <p>When programs with wide dynamic range, such as movie soundtracks, are played at low volume or from smaller speakers, the system can apply appropriate compression to preserve low-level content and prevent dramatic passages from getting too loud.</p> <p>The degree of compression can be made to vary according to need. If you want to hear the original dynamic range recorded on disc set the DYNAMIC to of OFF.</p> <p>Otherwise set to FULL then the dynamic range is reduced by bringing down the level of the loud sounds and bringing up the level of the quiet sounds.</p> |

Customizing the Function Settings

| SETUP MENU | ITEM and DESCRIPTIONS | | | |
|--------------------------------|---|--|--|--|
| SPEAKER SETUP | DIGITAL OUT | OFF ON | Control the output condition of digital coaxial out. Note : When "ON" is selected, DELAY TIME of each speaker can not be accessed. | |
| | FRONT POS. CENTER POS. REAR POS. | 30 FT/ 9.2 M : : : : 5 FT / 5.2 M | <p>In Dolby Digital or Dolby Pro Logic mode it is assumed that the time it takes the sound from each speaker to reach the listener, is the same. But if the time interval from the center or rear left and right speakers to the listener is closer than the time interval from the listener to the front left and right speaker, the sound of center or rear left and right speaker will reach the listener first; instead of the sound of the front speakers. (It is desirable that the sound from the front speakers reach the listener first.)</p> <p>Dolby Digital and Dolby Pro Logic modes provide speaker time delay adjustments to resolve this problem:: you can manually set delay time of the center or rear left and right speakers so that the sound from all speakers will arrive simultaneously to the listener.</p> | |
| | | TEST TONE | ON OFF | Turn on the TEST TONE for the speaker's relative volume balance from the listening position to each speaker. |
| | | MAIN PAGE | | Select MAIN PAGE and press ENTER to exit the Speaker setup. |
| VIDEO OUT | S-VIDEO R, G, B | | <p>Select the video output signal formats from the machine. Because VIDEO OUTPUT is useful only for selected signal format, select the appropriate item matching with TV input function.</p> <p>Note : The machine has component jack instead of scart jack in accordance with region. Though you select RGB, the machine having component jack is not useful for RGB video signal format.</p> | |
| AUDIO SUBTITLE DISC MENU | ENGLISH GERMAN FRENCH DUTCH ITALIAN SPANISH | | <p>AUDIO : Select a preferred language for the sound track. SUBTITLE : Select a preferred language for subtitles. DISC MENU : Select a preferred language for menus.</p> <p>Note : Selecting languages in the SET UP can be changed / added/ deleted in accordance with region.</p> | |
| DEFAULT | RESET | | Change the your settings to defaults. | |
| PARENTAL (DVD only) | 1 G 2 3 PG 4 PG13 5 6 PG-R 7 NC-7 8 ADULT 9 NO- PARENTAL | | <p>This function is to disable the playing of specified DVD that are unsuitable for children. As each disc has slightly different codes, please refer to the disc instruction. There are 8 levels. If the level is 8, the contents of the disc are suitable for adult. If the level is 1, the contents of the disc are suitable for child. If you didn't set a new password and level, there is no restriction playing discs.</p> <p>When you turn on this unit for the first time, setting the new password is recommended</p> | |
| PASSWORD (DVD only) | CHANGE | | Set/Change the password for the parental lock. If it is the first time changing password, input "0000" on old PASSWORD. | |

Recording Using the Connected Equipment

You can record according to the following using the connected recording equipment:

- Sound/picture of discs played back by the machine,
- Sound of FM programs, and
- Sound/picture of the connected source.

Note

Many discs and sources are copy protected. Copy protected sources are impossible to record.

◆ Simplified diagram of the connected equipment

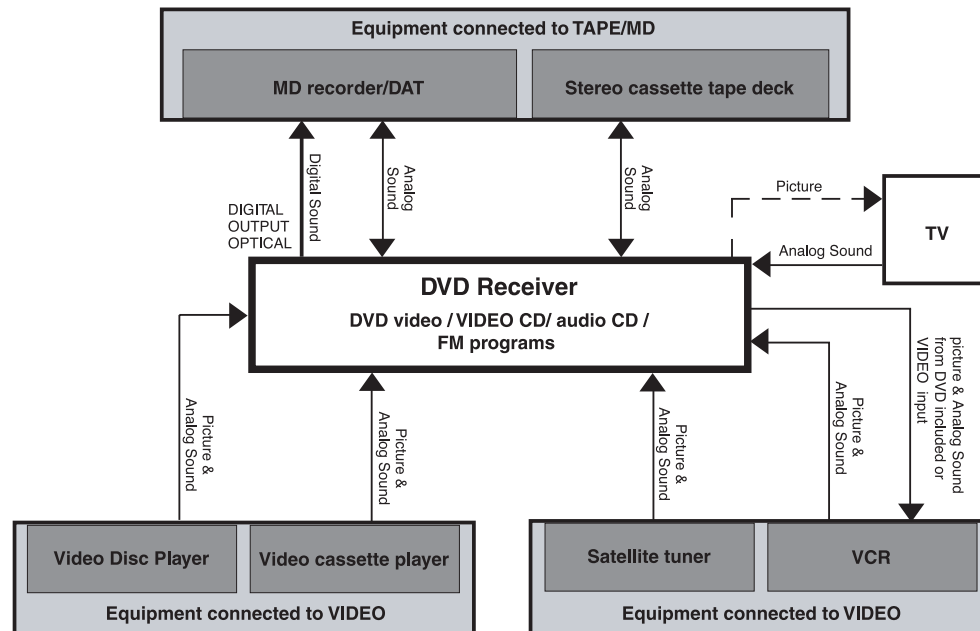

Basic Recording Procedure

1. Set the recording equipment (MD recorder, DAT, Stereo cassette tape deck, VCR, etc.) to recording pause.
2. Select the input source to be recorded, then set it to play pause.
3. Release the recording pause set in step 1 to start recording.
4. Start playback of the selected source in step 2.

Troubleshooting

Check the following guide for the possible cause of a problem before contacting service. Refer also to the respective instruction manuals of the connected components and TV.

| | Symptoms | Causes | Remedies |
|---------------------------|--|--|---|
| Amplifier | The machine doesn't switch on. | <ul style="list-style-type: none"> • The power cord is disconnected. • The main power is set to OFF. • There is external noise in the computer circuits of the machine. • The AC fuse is blown. | <ul style="list-style-type: none"> • Check the connection of the power cord. • Turn on the main power. • Switch off the main power, then switch it on again. If not recovered, disconnect the power cord, then connect it again. • Contact your nearest service center. |
| | No sound is reproduced. | <ul style="list-style-type: none"> • The muting function is activated. • The machine is not properly connected. • The amplifier protection circuitry has activated. | <ul style="list-style-type: none"> • Deactivate the muting function. • Check the connections to the machine. • Contact your nearest service center. |
| | No sound or very little sound is reproduced from the center speaker. | <ul style="list-style-type: none"> • The speakers are not properly connected. • The surround mode is set to "STEREO" • The volume level of the center speaker "CENTER" is set to minimum. | <ul style="list-style-type: none"> • Check the speaker connections. • Select the appropriate surround mode. • No sound is output from the center speaker when the surround mode is set to either of them. |
| | No picture appears on the TV screen. | <ul style="list-style-type: none"> • The TV is not set to receive the output signals from the machine. • The video cable is not connected securely. • Only S video connection is made. | <ul style="list-style-type: none"> • Set the TV to the machine's input. • Check the connections between the machine and TV set. • Make also video connection. |
| | The sound of the playback source is not heard. | <ul style="list-style-type: none"> • Another input source is selected. | <ul style="list-style-type: none"> • Select the appropriate input source. |
| DVD (VIDEO CD / Audio CD) | The buttons on the remote controller and machine do not operate. | <ul style="list-style-type: none"> • Power supply fluctuations or other abnormalities such as static electricity may interrupt correct operation. | <ul style="list-style-type: none"> • Switch off the main power, then switch it on again. If not recovered, disconnect the power cord, then connect it again. |
| | The machine does not start playback. | <ul style="list-style-type: none"> • No disc is inserted. • The region number of the disc is unmatched to the machine. • An unplayable disc is inserted. • The disc is placed upside down. • The disc is not placed within the disc tray guide. • The disc is dirty. • The parental lock function is activated. | <ul style="list-style-type: none"> • Insert a disc. (Check that "DVD," "VCD," or "CD" is lit in the machine's display.) • Only discs with the machine's playable region code (See region code of the machine's rear panel) or (Ⓜ), or with no region number can be played by the machine. • Check the playable discs. • Place the disc with the playback side down. • Place the disc within the proper guide on the disc tray. • Eject the disc and clean it. • Deactivate the parental lock function or change the parental lock level. |
| | Brightness is unstable or noise is visible on playback picture. | <ul style="list-style-type: none"> • Copy protection is activated. | <ul style="list-style-type: none"> • Connect the machine directly to the TV. Avoid connecting the machine to the TV through a VCR. |
| | The playback picture is occasionally distorted. | <ul style="list-style-type: none"> • The disc is dirty. • It is in fast forward or fast reverse playback. | <ul style="list-style-type: none"> • Eject the disc and clean it. • Sometime a small amount of picture distortion may appear. This is not a malfunction. |
| | Playback doesn't follow the course of the disc's programs. | <ul style="list-style-type: none"> • The machine is in repeat playback mode, memory playback mode, or random playback mode, etc. | <ul style="list-style-type: none"> • Resume normal playback. |
| | The picture from the machine doesn't appear on the TV screen. | <ul style="list-style-type: none"> • The TV is not set to receive the output signals from the machine. | <ul style="list-style-type: none"> • Set the TV to the machine's input. |
| | | | |

Troubleshooting

| | Symptoms | Causes | Remedies |
|-------------------|---|--|---|
| Tuner | Too much noise is heard or sound is interrupted occasionally. ("STEREO" indicator does not light steadily.) | <ul style="list-style-type: none"> FM stereo waves may produce a hiss noise when a certain level is reached. The position or direction of the FM antenna is incorrect. The station is too weak. | <ul style="list-style-type: none"> Switch the frequency receiving mode to mono. Lower the treble level. Adjust the position, height, and direction of the FM antenna. Connect an outdoor FM antenna. Try to use an antenna with more elements. (For installation of the outdoor antenna, consult your nearest dealer as it requires special skills and experience.) |
| | Sound is distorted or sound volume decreases. | <ul style="list-style-type: none"> The radio wave is distorted. Cars are running or airplanes are flying near the house. | - |
| | Sound is excessively distorted. | <ul style="list-style-type: none"> There is a tall building or a mountain nearby. [The waves transmitted from the transmission center (direct waves) and the waves diffracted by buildings or mountains (diffraction waves) interfere with each other causing multi pass distortion.] | - |
| Remote Controller | The buttons on the machine operate but the buttons on the remote controller do not operate. | <ul style="list-style-type: none"> No batteries are inserted in the remote controller. The batteries are worn out. The remote controller is not pointed at the remote sensor of the machine. The remote controller is too far from the machine. | <ul style="list-style-type: none"> Insert new batteries. Replace with new batteries. Point the remote controller at the remote sensor of the machine. Operate the remote controller within 5 m. |

Accessories

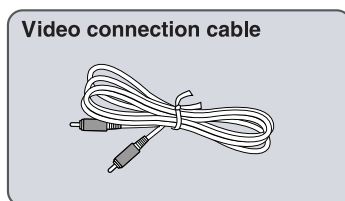
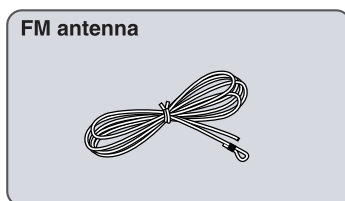
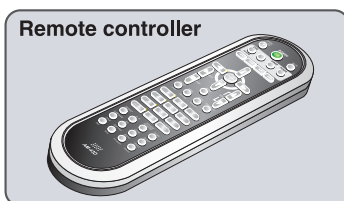

Specifications

General specifications

| | | | |
|-------------------------------|---|---------------------------------|----------------------------|
| Power supply Voltage (Option) | AC 110V ~ 127V or 220V ~ 240V (50/60Hz) | Power consumption | Standby 2.8Watt |
| | | | Operating 90Watt |
| | | Dimensions (W x D x H) / Weight | 430 x 380 x 55 mm / 6.7 kg |

Front Amp. Section

| | | |
|---|--------------------|-------------------|
| POWER OUTPUT at 10% THD(RMS) | At 1KHz, 6 ohms | 50W |
| THD(Total Harmonic Distortion) | At 1KHz, 10W | 0.1% |
| Input Sen. / Impedance @ 1KHz, 47K ohms | VIDEO | 200mV ± 30mV/47K |
| Output Level/Impedance @ 1KHz | Tape Rec | 200mV ± 30mV/2.2K |
| Frequency Response(Analogue) | at 1W : VIDEO -3dB | 20Hz~20KHz |
| S/N Ratio IHF-A Weighted | VIDEO | 70dB |
| Subwoofer Turnover Frequency | | ≤120Hz |
| Channel Separation | 1KHz | 55dB |

Center Amp Section

| | | |
|------------------------------|-----------------|-------------|
| POWER OUTPUT at 10% THD(RMS) | At 1KHz, 6 ohms | 50W |
| TOTAL HARMONIC DISTORTION | At 1KHz, 10W | 0.1% |
| S/N RATIO, IHF-A FILTER | Rated Output | 70dB |
| FRE. RESPONSE | 1W | 135Hz~18KHz |

Rear Amp Section

| | | |
|---------------------------|-----------------|-------------|
| POWER OUTPUT 10% THD(RMS) | At 1KHz, 6 ohms | 50W |
| TOTAL HARMONIC DISTORTION | At 1KHz, 10W | 0.1% |
| S/N RATIO DOLBY | Rated Output | 65dB |
| FREQUENCY RESPONSE | 1W | 135Hz~18KHz |

Woofer Section

| | | |
|-------------------------|------------------|------------|
| POWER OUTPUT at 10% THD | At 100Hz, 4 ohms | 80W |
| FREQUENCY RESPONSE | 1W | 20Hz~150Hz |
| S/N RATIO, IHF-A Weight | | 60dB |

Video Section

| | | | |
|----------------------|---------------------------------|-----------------------|------------|
| Input Sen./Impedance | Composite Video(Video) | 1Vp-p/75 ohm | ±0.5 dB |
| | Composite 75 ohm | 1Vp-p/75 ohm | ±0.5 dB |
| | S-Video(Y/C) 75 ohm(DVD only) | 1Vp-p/ 0.286Vp-p | ±0.5 dB |
| | Component Out(Y/ Cb/ Cr):Option | 1Vp-p/0.7Vp-p/0.7Vp-p | ±0.5 dB |
| Frequency Response | Ref 500KHz | | 5Hz~5.7MHz |
| Crosstalk | @1MHz | 45dB | 40dB |
| S/N Ratio | DVD | 60dB | |

FM Tuner Section (FM ANT Impedance : 75 ohms)

| | | |
|-----------------------------|---------------------------------|---------------|
| Tuning Range | USA Version | 87.5~108.0MHz |
| | Australia/Europe Version | 87.5~108.0MHz |
| Scanning | USA Version | 100KHz |
| | Australia/Europe Version | 50KHz |
| Frequency Interval | USA Version | 50KHz |
| | S/N=30dB, USA Version | 2uV(17.2dBf) |
| | S/N=26dB | 3uV(20.8dBf) |
| Usable Sensitivity, 75 ohms | Australia/Europe Version | |
| | Mono USA Version | 70dB |
| S/N Ratio @1mV IHF-A FILTER | Mono Australia/Europe Version | 70dB |
| | Stereo USA Version | 65dB |
| | Stereo Australia/Europe Version | 63dB |
| | | |

Power output Table

| Model | Power output at 10%THD(RMS) | | Remark |
|---------|-----------------------------|-------------|--------------------|
| | Front/Center | Woofer | |
| HC-4130 | 30 W, 6 ohm | 50 W, 6 ohm | Same to "X" Series |
| | | | |
| | | | |
| | | | |

To Add the Active Subwoofer System(User optional)

SUBwoofer SPEAKER PLACEMENT

Although the subwoofer can be installed in almost any location within the room, including next to an audio component system, deep bass reproduction is enhanced when it is installed in a corner or near a wall.

Because the propagation characteristics of low bass in music are omnidirectional, only one subwoofer may be sufficient for bass enhancement.

CONNECTIONS

Caution!

Before making the connections to avoid damaging to the amplifier or receiver and/or subwoofer, power off the units.

When connecting the subwoofer to an amplifier or receiver(not include), use the RCA Cable(Provided with subwoofer) with a dedicated subwoofer jack.

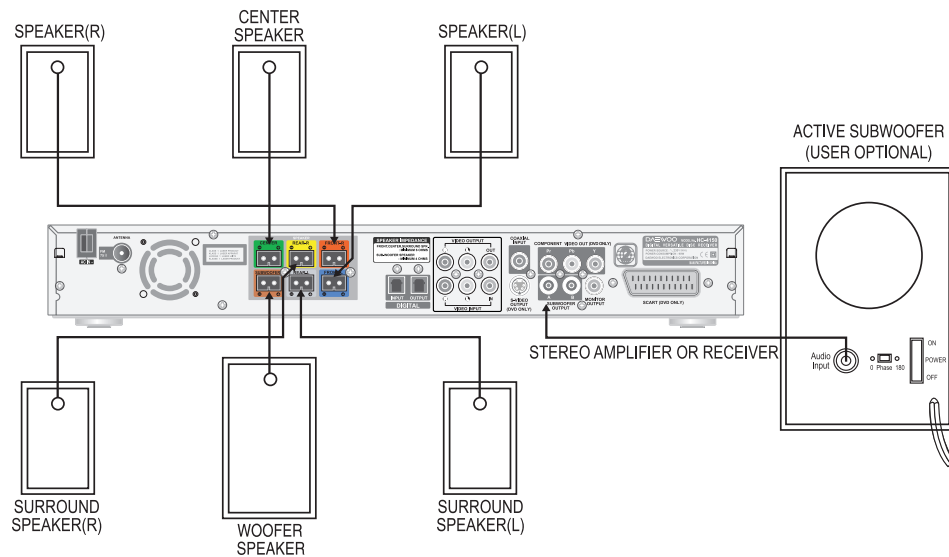

Specifications are subject to change without notice.

Free Manuals Download Website

<http://myh66.com>

<http://usermanuals.us>

<http://www.somanuals.com>

<http://www.4manuals.cc>

<http://www.manual-lib.com>

<http://www.404manual.com>

<http://www.luxmanual.com>

<http://aubethermostatmanual.com>

Golf course search by state

<http://golfingnear.com>

Email search by domain

<http://emailbydomain.com>

Auto manuals search

<http://auto.somanuals.com>

TV manuals search

<http://tv.somanuals.com>