

# Dell PowerEdge M1000e Systems Configuration Guide



# Notes, Cautions, and Warnings



**NOTE:** A NOTE indicates important information that helps you make better use of your computer.



**CAUTION:** A CAUTION indicates potential damage to hardware or loss of data if instructions are not followed.



**WARNING:** A WARNING indicates a potential for property damage, personal injury, or death.

---

**Information in this publication is subject to change without notice.**

**© 2008–2011 Dell Inc. All rights reserved.**

Reproduction of these materials in any manner whatsoever without the written permission of Dell Inc. is strictly forbidden.

Trademarks used in this text: Dell™, the DELL logo, PowerEdge™, PowerConnect™, and FlexAddress™ are trademarks of Dell Inc. Cisco® is a registered trademark of Cisco Systems, Inc. Microsoft®, Windows®, and Active Directory® are registered trademarks of Microsoft Corporation in the United States and/or other countries.

Other trademarks and trade names may be used in this publication to refer to either the entities claiming the marks and names or their products. Dell Inc. disclaims any proprietary interest in trademarks and trade names other than its own.

**March 2011      Rev. A05**

# Contents

1	About Your System	7
	<b>System Overview</b>	7
	<b>LCD Module</b>	11
	LCD Module Menus	12
	<b>Back-Panel Features</b>	14
	<b>Blades</b>	15
	<b>CMC Module</b>	22
	CMC Daisy Chaining (Enclosure Stacking)	23
	<b>iKVM Switch Module</b>	25
2	Initial System Configuration	27
	<b>Before You Begin</b>	27
	Power Requirements	27
	Network Information	27
	<b>Initial Setup Sequence</b>	27
	<b>Configuring the CMC</b>	28
	Initial CMC Network Configuration	28
	Logging in to the CMC Using the Web-Based Interface	31
	Adding and Managing CMC Users	32
	Configuring iDRAC Networking Using the Web-Based Interface	33

Setting the First Boot Device for Servers . . . . .	34
Configuring and Managing Power . . . . .	35
Installing or Updating the CMC Firmware . . . . .	35
<b>Configuring the Optional iKVM Switch Module . . . . .</b>	<b>38</b>
Enabling iKVM Access to the Dell CMC Console . . . . .	38
Updating the iKVM Firmware . . . . .	38
Tiering the Avocent iKVM Switch From an Analog KVM Switch . . . . .	39
Tiering the Avocent iKVM Switch From a Digital KVM Switch . . . . .	40
Viewing and Selecting Servers . . . . .	41
<b>FlexAddress . . . . .</b>	<b>43</b>
Activating FlexAddress . . . . .	44
<b>3 Configuring the I/O Modules . . . . .</b>	<b>47</b>
<b>Overview . . . . .</b>	<b>47</b>
Identifying Midplane Version . . . . .	49
<b>Before You Begin . . . . .</b>	<b>52</b>
Network Information . . . . .	52
<b>Switch Modules . . . . .</b>	<b>52</b>
Configuring a Switch Module Network Ethernet Port Using the Web-Based Interface . . . . .	52
Dell PowerConnect-KR 8024-k Switch . . . . .	53
Dell M8428-k 10 Gb Converged Network Switch . . . . .	55
Mellanox M2401G DDR Infiniband Switch I/O Module . . . . .	57
Mellanox M3601Q QDR Infiniband Switch I/O Module . . . . .	58

Cisco SFS M7000e Infiniband Switch I/O Module . . . . .	60
Cisco Catalyst Ethernet Switch I/O Modules . . . . .	61
PowerConnect M6220 Ethernet Switch I/O Module . . . . .	63
PowerConnect M6348 1 Gb Ethernet Switch I/O Module . . . . .	65
PowerConnect M8024 10 Gb Ethernet Switch I/O Module . . . . .	67
Brocade M4424 SAN I/O Module . . . . .	69
Brocade M5424 FC8 I/O Module . . . . .	71
Dell 8/4 Gbps FC SAN Module . . . . .	73
<b>Pass-Through Modules . . . . .</b>	<b>75</b>
Dell 10 GbE KR Pass-Through I/O Module . . . . .	75
Dell 8/4 Gbps Fibre Channel Pass-Through I/O Module . . . . .	77
10 Gb Ethernet Pass-Through Module II . . . . .	79
10 Gb Ethernet Pass-Through I/O Module . . . . .	81
10/100/1000 Mb Ethernet Pass-Through I/O Module . . . . .	83
4G Fibre Channel Pass-Through I/O Module . . . . .	85



# About Your System

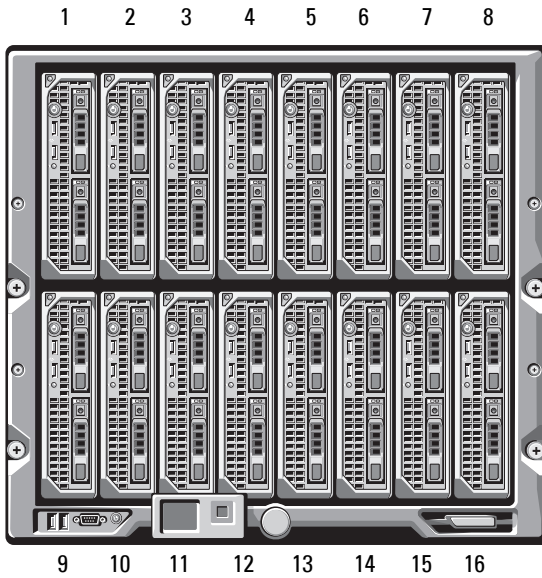
## System Overview

Your system can include up to 16 half-height blades (server modules), eight full-height blades, or a mixture of the two blade types (see Figure 1-1, Figure 1-2, and Figure 1-3). To function as a system, a blade is inserted into a Dell PowerEdge M1000e enclosure (chassis) that supports power supplies, fan modules, a Chassis Management Controller (CMC) module, and at least one I/O module for external network connectivity. The power supplies, fans, CMC, optional iKVM module, and I/O modules are shared resources of the blades in the enclosure.



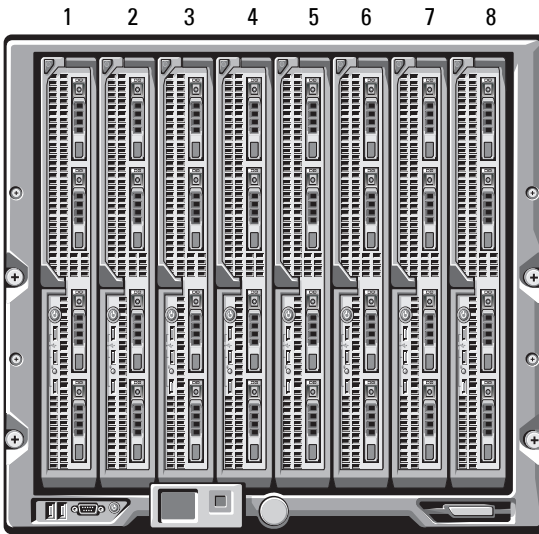
**NOTE:** To ensure proper operation and cooling, all bays in the enclosure must be populated at all times with either a module or with a blank.

**Figure 1-1. Blade Numbering—Half-Height Blades**





**Figure 1-2. Blade Numbering—Full Height Blades**



**Figure 1-3. Blade Numbering—Mixed Full-Height and Half-Height Blades**

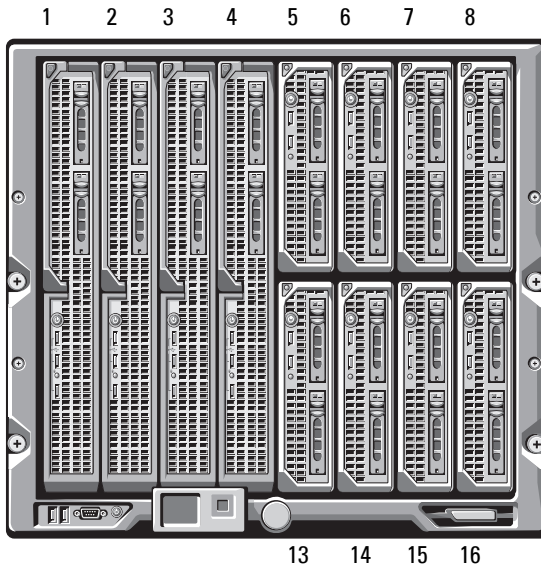
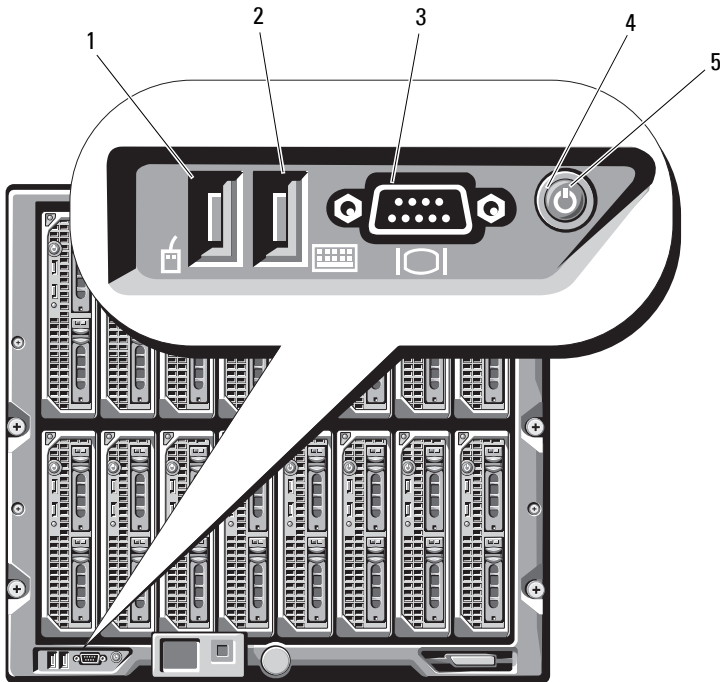


Figure 1-4 shows the control panel features on the M1000e enclosure panel.

**Figure 1-4. Control Panel Features**



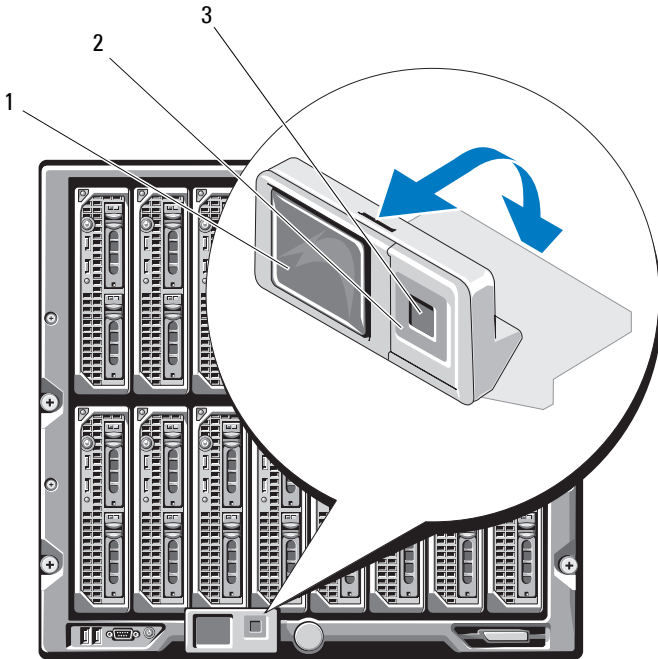
- |   |                        |   |                          |
|---|------------------------|---|--------------------------|
| 1 | USB port (mouse only)  | 2 | USB port (keyboard only) |
| 3 | video connector        | 4 | system power button      |
| 5 | system power indicator |   |                          |

**NOTE:** The USB and video ports are functional only if an optional iKVM module is installed.

# LCD Module

The LCD module provides an initial configuration/deployment wizard, as well as access to infrastructure and blade information, and error reporting. See Figure 1-5.

**Figure 1-5. LCD Module**



- 1 LCD screen
- 2 scroll buttons (4)
- 3 selection ("check") button

## LCD Module Menus

**Table 1-1. LCD Module Screen Navigation Keys**

<b>Keys</b>	<b>Action</b>
Left and right arrows	Use the left and right arrow keys to navigate through the options in a menu and to scroll text.
Up arrow or down arrow	Use the up and down arrow keys to navigate through the options in a menu, scroll text or increase a numerical value.
Center button	Use this button to select a menu option.

### Main Menu

The Main Menu options include links to the **LCD Setup Menu**, **Server Menu**, and **Enclosure Menu**.

### LCD Setup Menu

You can change the default language and start-up screen for the LCD menu screens using this menu.

### Server Menu

From the **Server Menu** dialog box, you can highlight each blade in the enclosure using the arrow keys, and view its status.

- A blade that is powered off or booting is designated by a gray rectangle. An active blade is indicated by a green rectangle. If a blade has errors, this condition is indicated by an amber rectangle.
- To select a blade, highlight it and press the center button. A dialog box displays the iDRAC IP address of the blade and any errors present.

## Enclosure Menu

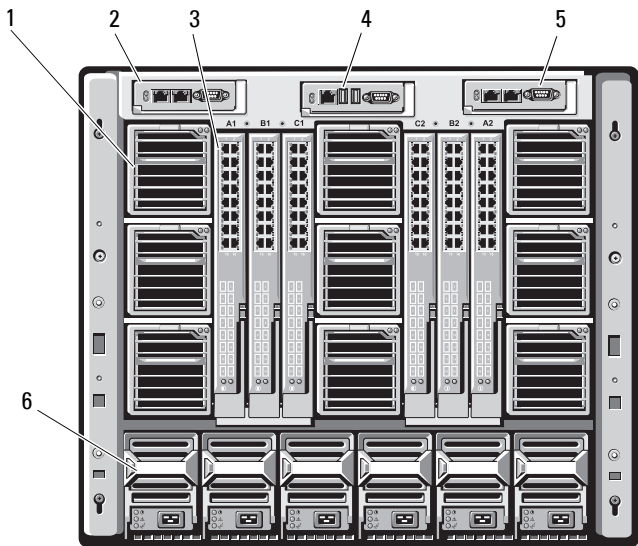
The **Enclosure Menu** includes options for **Module Status**, **Enclosure Status**, and **Network Summary**.

- In the **Module Status** dialog box, you can highlight each component in the enclosure and view its status.
  - A module that is powered off or booting is designated by a gray rectangle. An active module is indicated by a green rectangle. If a module has errors, it is indicated by an amber rectangle.
  - If a module is selected, a dialog box displays the current status of the module and any errors present.
- In the **Enclosure Status** dialog box, you can view the enclosure status, any error conditions, and power consumption statistics.
- The **Network Summary** screen lists the IP addresses for the CMC, the iDRAC in each blade, and other components in the enclosure.

# Back-Panel Features

The back panel of the M1000e enclosure supports six I/O modules, one or two CMC modules, an optional iKVM module, nine fan modules, and six power supply modules. Figure 1-6 shows a fully configured enclosure.

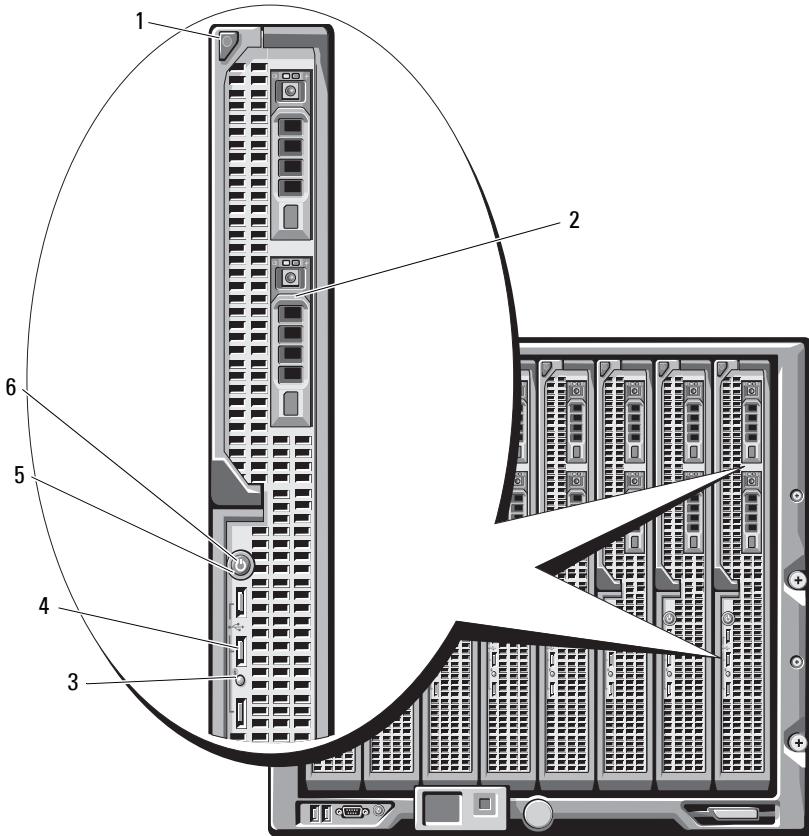
**Figure 1-6. Back Panel Features**



- |   |                      |   |                      |
|---|----------------------|---|----------------------|
| 1 | fan modules (9)      | 2 | primary CMC module   |
| 3 | I/O modules (6)      | 4 | optional iKVM module |
| 5 | secondary CMC module | 6 | power supplies (6)   |

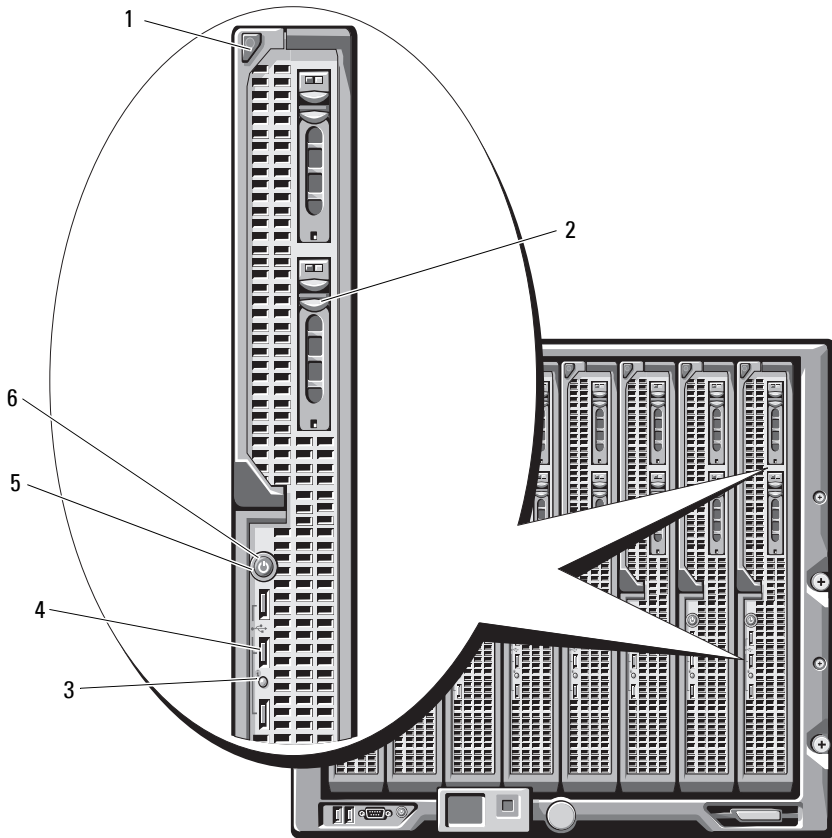
# Blades

Figure 1-7. Front Panel Features—PowerEdge M910



- |   |                                       |   |                       |
|---|---------------------------------------|---|-----------------------|
| 1 | blade-handle release button           | 2 | hard drives (2)       |
| 3 | blade status/identification indicator | 4 | USB connectors (3)    |
| 5 | blade power button                    | 6 | blade power indicator |

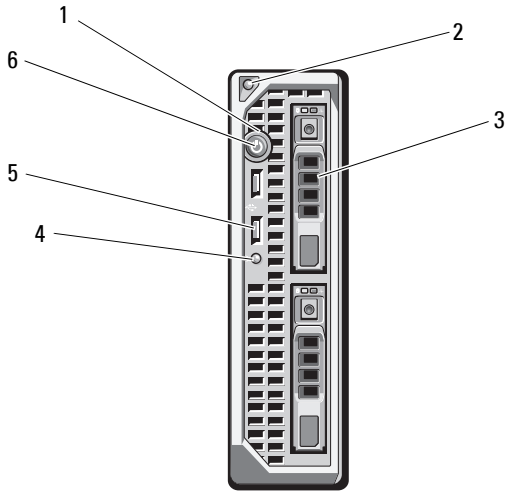
**Figure 1-8. Front Panel Features—PowerEdge M905 and M805**



- |   |                                       |   |                       |
|---|---------------------------------------|---|-----------------------|
| 1 | blade handle release button           | 2 | hard drives (2)       |
| 3 | blade status/identification indicator | 4 | USB connectors (3)    |
| 5 | blade power button                    | 6 | blade power indicator |

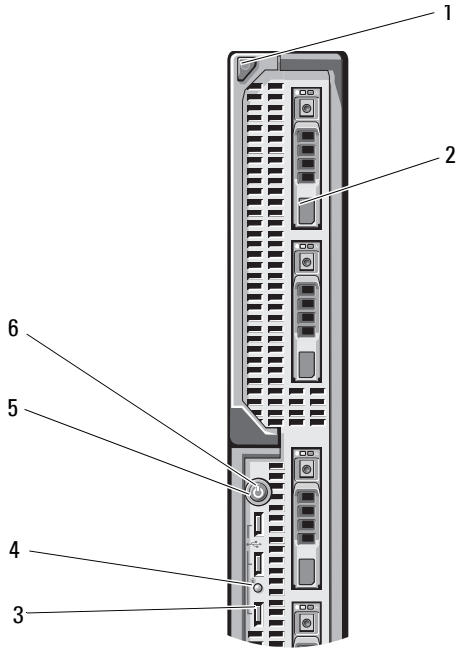


**Figure 1-9. Front Panel Features—PowerEdge M710HD**



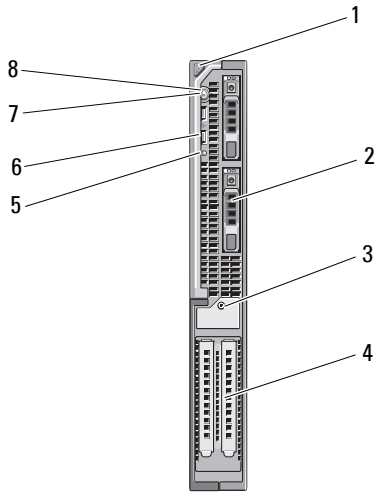
- |   |                       |   |                                       |
|---|-----------------------|---|---------------------------------------|
| 1 | blade power indicator | 2 | blade handle release button           |
| 3 | hard drives (2)       | 4 | blade status/identification indicator |
| 5 | USB connectors (2)    | 6 | blade power button                    |

**Figure 1-10. Front Panel Features—PowerEdge M710**



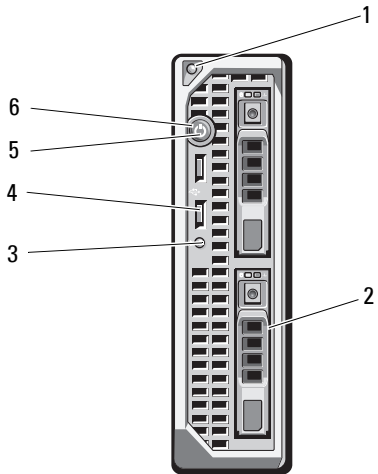
- |   |                             |   |                                       |
|---|-----------------------------|---|---------------------------------------|
| 1 | blade handle release button | 2 | hard drives (4)                       |
| 3 | USB connectors (3)          | 4 | blade status/identification indicator |
| 5 | blade power button          | 6 | blade power indicator                 |

**Figure 1-11. Front Panel Features—PowerEdge M610x**



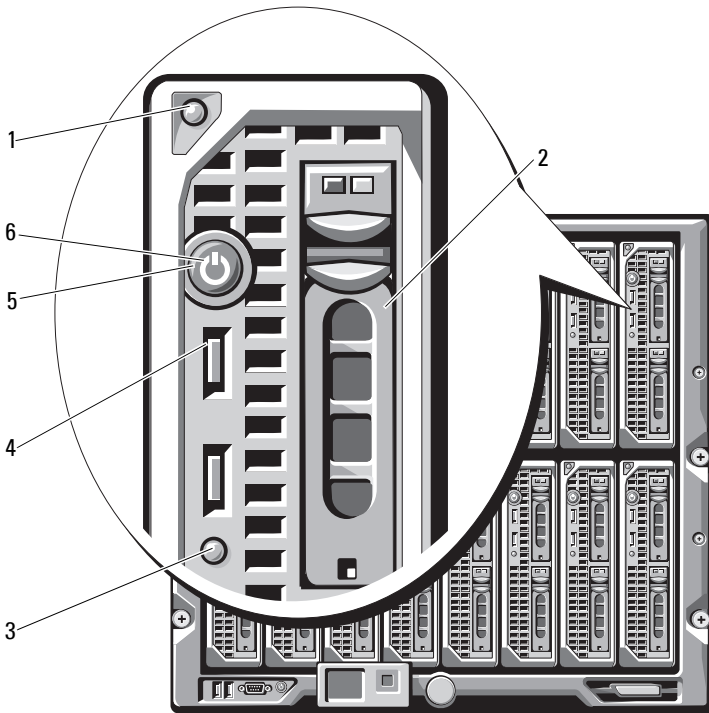
- |   |  |   |                          |
|---|--|---|--------------------------|
| 1 | blade handle release button                                      | 2 | hard drives (2)          |
| 3 | expansion-card filler-bracket retention latch with captive screw | 4 | expansion-card slots (2) |
| 5 | blade status/identification indicator                            | 6 | USB connectors (2)       |
| 7 | blade power button   | 8 | blade power indicator    |

**Figure 1-12. Front Panel Features—PowerEdge M610**



- |   |                                       |   |                       |
|---|---------------------------------------|---|-----------------------|
| 1 | blade handle release button           | 2 | hard drives (2)       |
| 3 | blade status/identification indicator | 4 | USB connectors (2)    |
| 5 | blade power button                    | 6 | blade power indicator |

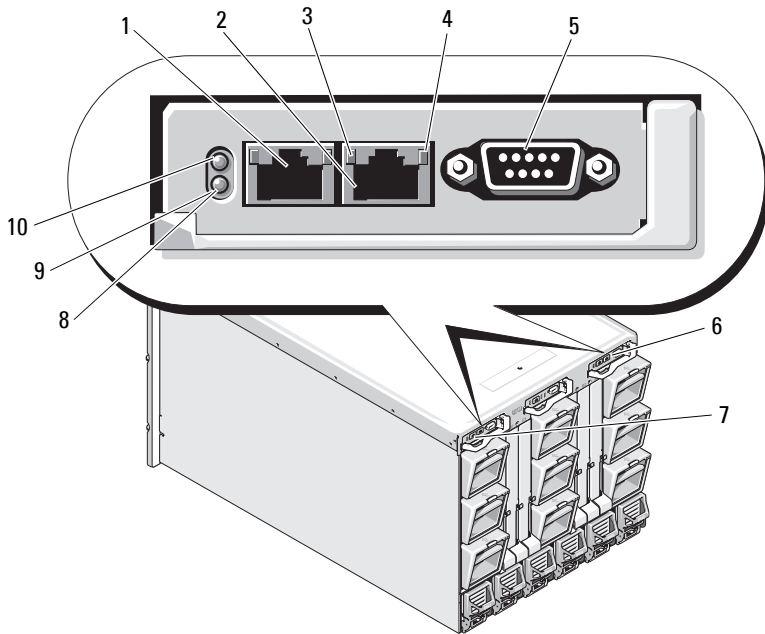
**Figure 1-13. Front Panel Features—PowerEdge M600 and M605**



- |   |                                       |   |                       |
|---|---------------------------------------|---|-----------------------|
| 1 | blade handle release button           | 2 | hard drives (2)       |
| 3 | blade status/identification indicator | 4 | USB connectors (2)    |
| 5 | blade power button                    | 6 | blade power indicator |

# CMC Module

Figure 1-14. CMC Module Features



- |   |   |    |  |
|---|---|----|--|
| 1 | Ethernet connector Gb1                        | 2  | Ethernet connector STK (used for daisy-chaining CMCs in separate enclosures) |
| 3 | link indicator (2)                            | 4  | activity indicator (2)   |
| 5 | DB-9 serial connector for local configuration | 6  | optional secondary CMC (CMC 2)   |
| 7 | primary CMC (CMC 1)                           | 8  | fault indicator  |
| 9 | status/identification indicator               | 10 | power indicator  |

The CMC provides multiple systems management functions for your modular server, including the M1000e enclosure's network and security settings, I/O module and iDRAC network settings, and power redundancy and power ceiling settings.

## CMC Daisy Chaining (Enclosure Stacking)

CMC daisy chaining can be utilized to minimize the number of network connections required for chassis (enclosure) management, such that only one or two network connections (depending on whether or not redundant CMCs are installed) are needed for up to four M1000e enclosures.

### Cabling Guidelines

Follow these guidelines to daisy chain CMC modules from enclosure to enclosure:

- CMC Ethernet port GB1 is the Uplink port. It uplinks to either the management network, or to receive a cable from the CMC Ethernet port labeled STK in the adjacent enclosure.

The CMC Ethernet port labeled STK is the daisy-chain port. It connects *only* to CMC port GB1 on the adjacent enclosure. Do not connect this cable directly to the management network.

- Up to four enclosures can be daisy chained.
- Enclosures can be daisy chained in both redundant and non-redundant deployments:
  - In a redundant CMC deployment, cable all CMC modules in the CMC primary slots together. Cable all CMC modules in the CMC secondary slots together.

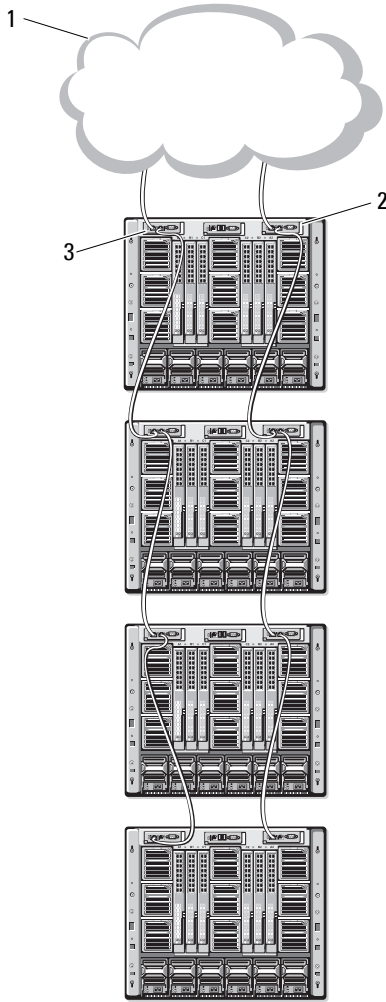


**NOTE:** Do not connect the primary daisy chain with the secondary daisy chain (do not cross cable the two sets of CMCs).

- In a non-redundant CMC, cable all CMC modules in the CMC primary slots together.

Figure 1-15 shows four enclosures with redundant CMC modules installed. Primary CMC port GB1 in the first enclosure connects to the management network. Primary CMC port GB1 in the adjacent enclosure is uplinked into the port labeled STK on the primary CMC in the enclosure above it. No cable is required in port STK on the fourth enclosure in line. The same cabling scheme is valid for the daisy chain of CMC modules in the secondary slot of the enclosures.

**Figure 1-15. CMC Daisy Chaining—Enclosure With Redundant CMC Modules**



- 1 management network segment
- 2 CMC1—cable from connector Gb1 to network
- 3 CMC2—cable from connector Gb1 to network



## iKVM Switch Module

The optional Avocent iKVM analog switch module provides connections for a keyboard, video (monitor), and mouse. It includes the following:

- Local iKVM access can be remotely disabled on a per blade basis, using the blade's iDRAC interface (access is enabled by default).



**NOTE:** By default (enabled), a console session to a given blade is available to both the iDRAC interface and an iKVM (user connected to a blade's console through iDRAC and the iKVM sees the same video and be able to type commands). Use the iDRAC console interface to disable the sharing of the console session.

- The following connectors:
  - One VGA connector. The iKVM supports a video display resolution range from 640 x 480 at 60 Hz up to 1280 x 1024 x 65,000 colors at 75 Hz.
  - Two USB ports for keyboard and mouse.



**NOTE:** The iKVM USB ports do not support storage devices.

- RJ-45 ACI port for tiering with Dell and Avocent analog KVM and KVM over IP switches with ARI ports.



**NOTE:** Although the ACI port is an RJ-45 connector and uses Cat5 (or better) cabling, it is not an Ethernet network interface port. It is only used for connection to external KVM switches with Analog Rack Interface (ARI) ports, and does not support native KVM over IP.

The iKVM can also be accessed from the front of the enclosure, providing front or rear panel KVM functionality, but not at the same time. For enhanced security, front panel access can be disabled using the CMC's interface.

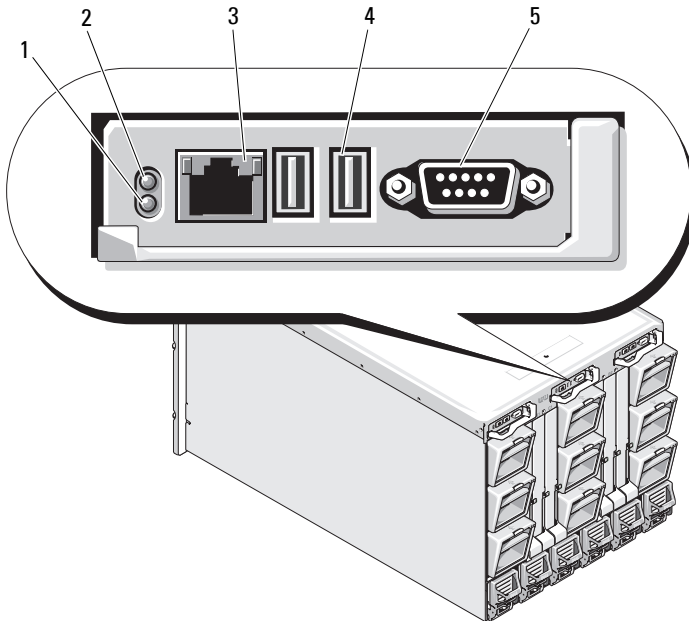


**NOTE:** Connecting a keyboard, video, and mouse to the enclosure front panel disables video output to the iKVM back-panel port. It does not interrupt iDRAC video and console redirection.

You can use the iKVM to access the CMC using the Command Line Interface. For more information, see "Using the iKVM Module" in the CMC *User's Guide*.

Figure 1-16 shows the external features of the iKVM module.

**Figure 1-16. Avocent iKVM Switch Module**




- |   |                                      |   |   |
|---|--------------------------------------|---|---|
| 1 | identification indicator             | 2 | status indicator                          |
| 3 | ACI port for tiering connection only | 4 | USB connectors (2) for keyboard and mouse |
| 5 | video connector                      |   |   |

**CAUTION:** Do not connect the ACI port to a LAN device such as a network hub. Doing so may damage the equipment.

# Initial System Configuration

## Before You Begin



### Power Requirements

-  **CAUTION:** The enclosure power supplies must be connected to a Type B or permanently-connected PDU and not directly to an electrical outlet. The power supplies require a 100–120 V or 200–240 V power source. You can select only one AC power input, as the system does not operate at both ranges simultaneously.

### Network Information

If your network uses static addressing, you need the IP address, subnet mask, and gateway to configure the CMC and other modules in the enclosure.

## Initial Setup Sequence

- 1 Unpack the enclosure and install it in a rack.  
For more information, see the *Getting Started Guide* and *Rack Installation Guide* at [support.dell.com/manuals](http://support.dell.com/manuals).
-  **CAUTION:** Do not turn on the blades (server modules) until you have configured the switch modules, as described in "Configuring the I/O Modules" on page 47.
- 2 Connect the power supply units to a PDU.
- 3 If an optional iKVM module is installed, connect the keyboard, video, and mouse to the enclosure control panel (see Figure 1-4) or to the iKVM module (see Figure 1-16).
  -  **NOTE:** Connecting a keyboard, video, and mouse to the enclosure front panel disables video output to the iKVM back panel port.
- 4 Press the power button on the enclosure control panel. See Figure 1-4.

**5** Configure the CMC network settings.

The LCD Configuration Wizard allows you to quickly configure the CMC and iDRAC management interfaces and manage the enclosure remotely. See "Configuring the CMC Network Settings Using the LCD Configuration Wizard" on page 28.

You can also use a management station and the RACADM CLI to configure the CMC. See "Configuring the CMC Network Settings Using a Management Station and CLI" on page 30.

**6** Configure the IO modules to allow proper network or storage management or paths. See "Configuring the I/O Modules" on page 47.

**7** Once the Ethernet and Fibre Channel switches are configured, you can power on your server blades. This allows time for the Ethernet switch to boot and allow PXI \UNDI traffic for all blade modules.

## Configuring the CMC

### Initial CMC Network Configuration

#### **Connecting to the CMC Using a Network Connection and the Default IP Address, or a User-Defined IP Address**


The CMC is preset for DHCP. To use a static IP address, you must toggle the CMC setting from DHCP to a static address by either running the LCD Configuration Wizard, or by using a management station and CLI commands.


If toggled to use a static address, the CMC IP address defaults to the standard IP address settings of 192.168.0.120, 255.255.255.0, and gateway of 192.168.0.1. You can change this address to an IP address of your choice.

For initial configuration instructions, see "Configuring the CMC Network Settings Using the LCD Configuration Wizard" on page 28. To use a management station/local connection and CLI, see "Configuring the CMC Network Settings Using a Management Station and CLI" on page 30.


#### **Configuring the CMC Network Settings Using the LCD Configuration Wizard**

When you first start up your system, the screen on the LCD module directs you to configure the CMC network settings.

 **NOTE:** The option to configure the enclosure using the LCD Configuration Wizard is only available until the CMC default password is changed or when the LCD Configuration Wizard is complete. Thereafter, use the RACADM CLI or the web-based GUI to change the CMC settings (see "Configuring the CMC Network Settings Using a Management Station and CLI" on page 30).


 **NOTE:** The serial null modem cable for the CMC is an option. You can access the CLI using the 17th Blade feature on the embedded iKVM module. Blade number 17 is a direct local connection to the CMC.

- 1 Choose a language from the options presented in the dialog box.
- 2 Start the LCD Configuration Wizard.
- 3 Configure the CMC network settings for your network environment.

 **NOTE:** The CMC external management network mode is set by default to DHCP. To use a static IP address, you must change the setting using the LCD Configuration Wizard.

- Network speed
- Duplex mode
- Protocol (IPv4 and/or IPv6)
- Network mode (DHCP or static)
- Static IP address, subnet mask, and gateway values (if static mode was selected)
- DNS setting, including a registered CMC name, (if DHCP mode was selected)

- 4 If required, configure the iDRAC network setting for DHCP mode.

 **NOTE:** You cannot set a static IP address for the iDRAC using the LCD Configuration Wizard. See "Configuring iDRAC Networking Using the Web-Based Interface" on page 33.

- 5 Review the settings on the **Network Summary** screen.
  - If the settings are correct, press the center button to close the configuration wizard and return to the **Main Menu**.
  - If the settings are not correct, use the left arrow key to return to the screen for that setting and correct it.

The **Network Summary** screen lists the IP addresses for the CMC and the iDRAC network settings.

After you complete the LCD Configuration Wizard, you can access the CMC on the network using the Web-based CMC interface or text-based interfaces such as a serial console, Telnet, or SSH.

Note that if you intend to use static addresses rather than DHCP to access the iDRACs, you must configure them using the CMC Web-based interface or CLI.

### **Configuring the CMC Network Settings Using a Management Station and CLI**

The LCD Configuration Wizard is the quickest way to initially configure the CMC network settings. However, you can also use a management station and a local connection to access the CMC. There are two ways to create a local connection to the CMC:

- The CMC Console using the optional iKVM. Press <Print Screen> and select blade number 17.
- Serial connection using an optional null modem cable (115200 bps, 8 data bits, no parity, 1 stop bit, and no flow control).

Once you have established a connection to the CMC, you can complete the initial CMC network configuration:

- 1 Log in to the CMC.

The default user name is `root` and the default password is `calvin`.

- 2 Type `getniccfg` and press <Enter> to view the current CMC network parameters.

### 3 Configure the CMC network settings:

- To set a static IP address, type  
`setniccfg -s<IP address><network mask><gateway>`  
and press <Enter>.

Use the appropriate settings for your network.

- To configure the CMC to obtain an IP address using DHCP, type  
`setniccfg -d`  
and press <Enter>.

The new network settings are activated in a few seconds after configuring the network.

## Logging in to the CMC Using the Web-Based Interface

### 1 Open a supported Web browser window.

For more information, see "Supported Web Browsers" in the *CMC User's Guide*.

### 2 Log in to the CMC.

- If the CMC is accessed using a specific IP address, type the following URL in the **Address** field, and then press <Enter>:

`https://<CMC IP address>`

The default IP address for the CMC is 192.168.0.120. If the default HTTPS port number (port 443) has been changed, type:

`https://<CMC IP address>:<port number>`


where <IP address> is the IP address for the CMC and *port number* is the HTTPS port number.


- If you access the CMC using a registered DNS name, type the CMC's name:


`https://<CMC name>`

By default, the CMC name on the DNS server is `cmc-<service tag>`.

The CMC **Login** page is displayed.

 **NOTE:** The default CMC user name is `root`, and the password is `calvin`. The `root` account is the default administrative account that ships with the CMC. For added security, you should change the default password of the `root` account during initial setup.

 **NOTE:** The CMC does not support extended ASCII characters, such as ß, å, é, ü, or other characters used primarily in non-English languages.

 **NOTE:** You cannot log in to the Web-based interface with different user names in multiple browser windows on a single workstation.


You can log in as either a CMC user or as Directory Service user in Microsoft Active Directory or Lightweight Directory Access Protocol Services (LDAP).

**3** In the **Username** field, type your user name:

- CMC user name: `<user name>`
- Active Directory user name: `<domain>\<user name>`,  
`<domain>/<user name>` or `<user>@<domain>`.
- LDAP user name: `<user name>`


 **NOTE:** This field is case sensitive.

**4** In the **Password** field, type your CMC user password or Active Directory user password.

 **NOTE:** This field is case-sensitive.

## Adding and Managing CMC Users

From the **Users** and **User Configuration** pages in the Web-based interface, you can view information about CMC users, add a new user, and change settings for an existing user.

 **NOTE:** For added security, it is highly recommended that you change the default password of the `root` (User 1) account. The `root` account is the default administrative account that ships with the CMC.

To change the default password for the `root` account, click **User ID 1** to open the **User Configuration** page. Help for that page is available through the **Help** link at the top right corner of the page.

 **NOTE:** You must have **User Configuration Administrator** privileges to perform the following steps.



- 1 Log in to the Web-based interface. See "Logging in to the CMC Using the Web-Based Interface" on page 31.
- 2 Select **Chassis** in the system tree.
- 3 Click the **Network/Security** tab, and then click the **Users sub-tab**. The **Users** page appears, listing each user's user ID, login state, user name, and CMC privilege, including those of the root user. User IDs available for configuration have no user information displayed.
- 4 Click an available user ID number. The **User Configuration** page is displayed.

To refresh the contents of the **Users** page, click **Refresh**. To print the contents of the **Users** page, click **Print**.

- 5 Select general settings for the users.

For details on user groups and privileges, see "Adding and Configuring Users" in the *CMC User's Guide*.


- 6 Assign the user to a CMC user group.

When you select a user privilege setting from the CMC Group drop-down menu, the enabled privileges (shown as checked boxes in the list) are displayed according to the pre-defined settings for that group.


You can customize the privileges settings for the user by using the check boxes. After you have selected a CMC Group or made Custom user privilege selections, click **Apply Changes** to save the settings.

## Configuring iDRAC Networking Using the Web-Based Interface

Follow this procedure if you did not configure the iDRAC in the LCD Configuration Wizard.

 **NOTE:** If you did not configure the iDRAC using the LCD Configuration Wizard, the iDRAC is disabled until you configure it using the Web-based interface

 **NOTE:** You must have Chassis Configuration Administrator privileges to set up iDRAC network settings from the CMC.

 **NOTE:** The default CMC user name is **root** and the default password is **calvin**.

- 1 Log in to the Web-based interface. See "Logging in to the CMC Using the Web-Based Interface" on page 31.

- 2 Click the plus (+) symbol next to **Chassis** in the left column, then click **Servers**.
- 3 Click **Setup** → **Deploy**.
- 4 Select the protocol for the iDRAC setting (IPv4 and/or IPv6).
- 5 Enable the LAN for the iDRAC on the server by selecting the check box next to the server beneath the **Enable Lan** heading.
- 6 Enable or disable IPMI over LAN by using the check box next to the server under the **Enable IPMI over LAN** heading.
- 7 Enable or disable DHCP for the iDRAC by checking or unchecking the check box next to the server under the **DHCP Enabled** heading.
- 8 If DHCP is disabled, enter the static IP address, netmask, and default gateway for the iDRAC.
- 9 Click **Apply** at the bottom of the page.

## Setting the First Boot Device for Servers

The **First Boot Device** page allows you to specify the boot device for each blade. You can set the default boot device and you can also set a one-time boot device so that you can boot a special image to perform tasks such as running diagnostics or reinstalling an operating system.

To set the first boot device for some or all servers in the chassis:

- 1 Log in to the CMC Web-based interface.
- 2 Click **Servers** in the system tree and then click **Setup** → **Deploy First Boot Device**. A list of servers is displayed, one per row.
- 3 Select the boot device you want to use for each server from the list box.
- 4 If you want the server to boot from the selected device every time it boots, unselect the **Boot Once** check box for the server.

If you want the server to boot from the selected device only on the next boot cycle, select the **Boot Once** check box for the server.


- 5 Click **Apply**.

## Configuring and Managing Power

You can use the Web-based and RACADM interfaces to manage and configure power controls on the CMC, as outlined in the following sections. For detailed information on the various power management options, see "Power Management" in the *CMC User's Guide*.


### Configuring Power Budget and Redundancy

The CMC's power management service optimizes power consumption for the entire chassis (the chassis, servers, I/O modules, iKVM, CMC, and PSUs) and re-allocates power to different modules based on the demand.


 **NOTE:** To perform power management actions, you must have **Chassis Control Administrator** privileges.

- 1 Log in to the CMC Web-based interface.
- 2 Select **Chassis** in the system tree.
- 3 Click the **Power Management** tab. The **Power Budget Status** page is displayed.
- 4 Click the **Configuration** sub-tab. The **Budget/Redundancy Configuration** page is displayed.
- 5 Configure the power budget and redundancy settings based on the components in the enclosure and your needs.
- 6 Click **Apply** to save your changes.

### Installing or Updating the CMC Firmware

 **NOTE:** It is normal for some or all of the fan units to spin at 100 percent during CMC or iDRAC firmware updates on a server.

### Updating Firmware in a Redundant CMC Configuration

 **NOTE:** In redundant CMC configuration, care must be taken to update CMC firmware on both modules. Failure to do so may cause unexpected behavior during a CMC failover or failback. Use the following procedure for redundant CMC deployments.

- 1 Locate the secondary or standby CMC by using the `RACADM getsysinfo` command, or by using the **Chassis Summary** page in the **Web-based interface**. Visually, the status indicator is solid blue on the primary or active CMC module and off on the standby or secondary CMC (see Figure 1-14).
- 2 Update the firmware on the standby CMC first. See "Updating the CMC Firmware Using the Web-Based Interface" on page 37 or "Updating the CMC Firmware Using RACADM" on page 37.
- 3 Verify that the secondary or standby CMC's firmware is at the requested level with the `getsysinfo` command or through the **Web-based interface**.
- 4 After the standby CMC has rebooted, update the firmware on the active or primary CMC. Please allow 10 minutes for the standby CMC to boot.  
See "Updating the CMC Firmware Using the Web-Based Interface" on page 37 or "Updating the CMC Firmware Using RACADM" on page 37.
- 5 Verify that the active or primary CMC firmware is at the requested level using the `getsysinfo` command or through the **Web-based interface**.
- 6 Once both CMCs are updated to the same firmware revision, use the `cmchangeover` command to reset the CMC in the left slot as primary.

### Downloading the CMC Firmware

Before beginning the firmware update, download the latest firmware version from [support.dell.com](http://support.dell.com), and save it to your local system.

The following software components are included with your CMC firmware package:


- Compiled CMC firmware code and data
- Web-based interface, JPEG, and other user interface data files
- Default configuration files

Use the **Firmware Update** page to update the CMC firmware to the latest revision. When you run the firmware update, the update retains the current CMC settings.



**NOTE:** The firmware update, by default, retains the current CMC settings. During the update process, you have the option to reset the CMC configuration settings back to the factory default settings.

## Updating the CMC Firmware Using the Web-Based Interface

- 1 Log in to the Web-based interface. See "Logging in to the CMC Using the Web-Based Interface" on page 31.
- 2 Click **Chassis** in the system tree.
- 3 Click the **Update** tab. The **Updatable Components** page is displayed.
- 4 On the **Updatable Components** page, click the CMC name. The **Firmware Update** page is displayed.
- 5 In the **Value** field, type the path on your management station or shared network where the firmware image file resides, or click **Browse** to navigate to the file location.  
 **NOTE:** The default CMC firmware image name is **firmimg.cmc** and the filename should not be changed. Care must be taken to keep different firmware revisions separated as the file name always remains the same.
- 6 Click **Update**. A dialog box appears asking you to confirm the action.
- 7 Click **Yes** to continue. The firmware transfer process begins and the status displays the message **Firmware Update in Progress**. Once the CMC update is complete, the CMC is reset. Once the reset is complete, you must refresh the User Interface page to then log in again.

## Updating the CMC Firmware Using RACADM

- 1 Open a CMC command line console and log in.
- 2 Type:

```
racadm fwupdate -g -u -a <TFTP server IP address>  
-d <filepath> -m <cmc-active|cmc-standby>
```

See the latest *Dell Chassis Management Controller User's Guide* at [support.dell.com/manuals](http://support.dell.com/manuals) for complete instructions on how to configure and operate the CMC module.

# Configuring the Optional iKVM Switch Module

## Enabling iKVM Access to the Dell CMC Console

Enabling access to the CMC allows you to access the CMC directly and securely through the iKVM's CMC Console option. To enable the CMC Console using the Web-based interface:

- 1 Log in to the CMC Web-based interface.
- 2 Select iKVM in the system tree. The **iKVM Status** page is displayed.
- 3 Click the **Setup** tab. The **iKVM Configuration** page is displayed.
- 4 Select **Allow access to CMC CLI from iKVM**.
- 5 Click **Apply** to save the setting.

## Updating the iKVM Firmware



**NOTE:** The iKVM resets and becomes temporarily unavailable after the firmware has been uploaded successfully.

- 1 Log in to the CMC's Web-based interface. See "Logging in to the CMC Using the Web-Based Interface" on page 31.
- 2 Select **Chassis** in the system tree.
- 3 Click the **Update** tab. The **Updatable Components** page is displayed.
- 4 Click the iKVM name. The **Firmware Update** page is displayed.
- 5 In the **Value** field, type the path on your management station or shared network where the firmware image file resides, or click **Browse** to navigate to the file location.



**NOTE:** The default iKVM firmware image name is **ikvm.bin**. However, the iKVM firmware image name can be renamed. If you are unable to locate **ikvm.bin**, determine whether another user has renamed the file.

- 6 Click **Update**. A dialog box appears asking you to confirm the action.
- 7 Click **Yes** to continue.

When the update is complete, the iKVM resets.

## Tiering the Avocent iKVM Switch From an Analog KVM Switch

The Avocent iKVM switch can be tiered from analog KVM switches such as the Dell 2160AS and 180AS, as well as many Avocent analog KVM switches. Many switches may be tiered without the need for a Server Interface Pod (SIP) (see Table 2-1).

**Table 2-1. Cabling Requirements for External Analog KVM Switches**

Switch	Tiering Cabling Requirements
Dell PowerConnect 180AS, 2160AS (version 1.0.3.2 or later)	Seamless tiering using ACI port and Cat 5 cable
Avocent Autoview 2020, 2030 (version 1.6.0.4 or later)	
Avocent Autoview 1400, 1500, 2000, 1415, 1515, 2015	Avocent USB SIP (DSRIQ-USB) required with Cat 5 cable

Before connecting the iKVM switch to a supported analog switch, you must set the iKVM switch to display in slot order, and set the **Screen Delay Time** to 1 or more seconds:

- 1 Press <Print Screen> to launch the iKVM Switch OSCAR.
- 2 Click **Setup** → **Menu**. The **Menu** dialog box is displayed.
- 3 Select **Slot** to display servers numerically by slot number.
- 4 Enter a screen delay time of at least 1 second.
- 5 Click **OK**.

Setting the Screen Delay time to 1 second allows you to soft switch to a server without launching OSCAR.



**NOTE:** Soft switching allows you to switch servers using a hot key sequence. You can soft switch to a server by pressing <Print Screen> and then typing the first few characters of its name or number. If you have a Delay Time set and you press the key sequences before that time has elapsed, OSCAR does not display.

To configure the analog switch:

- 1 Press <Print Screen> to open the OSCAR **Main** dialog box.
- 2 Click **Setup** → **Devices** → **Device Modify**.
- 3 Select the 16-port option to match the number of blades in your system.

- 4 Click **OK** to exit OSCAR.
- 5 Press <Print Screen> to verify that the settings have taken effect. The slot number of the blade to which the iKVM switch is now attached should be expanded to display each of the slot locations of the blades in the system. For instance, if the iKVM switch is attached to slot 1, it would now be displayed as 01-01 to 01-16.

To connect the Avocent iKVM switch to a supported analog switch:

- 1 *If the switch does not require a SIP to connect to the iKVM (see Table 2-1), connect a Cat5 (or newer) cable to the RJ-45 ACI port on the iKVM module. See Figure 1-16.*

Connect the other end of this cable to the ARI port on the external switch.

*If the analog switch requires a USB SIP (see Table 2-1), connect an Avocent USB SIP to the iKVM, then connect a Cat5 (or newer) cable to the SIP.*

Connect the other end of this cable to the ARI port on the external switch.

- 2 Connect both the analog switch and the system to an appropriate power source.
- 3 Turn on the system.
- 4 Turn on the external analog switch.



**NOTE:** If the external analog switch is powered up before the system, it may result in only one blade being displayed in the analog switch OSCAR, instead of 16. If this behavior occurs, shut down and restart the switch so the entire complement of blades is recognized.



**NOTE:** In addition to the steps outlined above, some external analog switches may require you to perform additional steps to ensure that the iKVM switch blades appear in the external analog switch OSCAR. See the external analog switch documentation for additional information.

## **Tiering the Avocent iKVM Switch From a Digital KVM Switch**

The iKVM module may also be tiered from a digital KVM switch such as the Dell 2161DS-2 or 4161DS, or a supported Avocent digital KVM switch. Many switches may be tiered without the need for a SIP (see Table 2-2).



**Table 2-2. Cabling Requirements for External Digital KVM Switches**

Switch	Tiering Requirements
Dell PowerConnect 2161DS, 4161DS, 2161DS-2, 2321DS (version 1.3.40.0 or later)	Seamless tiering using ACI port and Cat 5 cable
Avocent DSR x02x (except 1024), x03x (version 3.6 or later)	
Avocent DSR 800, x16x, x010, 1024	Avocent USB SIP (DSRIQ-USB) required with Cat 5 cable

To tier the iKVM module from a Dell 2161DS, 180AS, or 2160AS console switch:

- *If the switch does not require a SIP to connect to the iKVM (see Table 2-2), connect a Cat5 (or newer) cable to the RJ-45 ACI port on the iKVM module. See Figure 1-16.*

Connect the other end of this cable to the ARI port on the external switch.

- *If the switch requires a USB SIP (see Table 2-1), connect an Avocent USB SIP to the iKVM, then connect a Cat5 (or newer) cable to the SIP. Connect the other end of this cable to the ARI port on the external switch.*

Once the KVM switch is connected, the server modules appear in OSCAR.



**NOTE:** When the local system is set up, you must also resynchronize the server list from the Remote Console Switch software in order to see the list of blades. See "Resynchronizing the Server List at the Remote Client Workstation" on page 42.

## Viewing and Selecting Servers

Use the OSCAR **Main** dialog box to view, configure, and manage servers in the M1000e enclosure through the iKVM. You can view the servers by name or by slot. The slot number is the chassis slot number the server occupies. The **Slot** column indicates the slot number in which a server is installed.



**NOTE:** Server names and slot numbers are assigned by the CMC.



**NOTE:** If you have enabled access to the CMC through the iKVM, an additional option, Dell CMC Console, is displayed. To enable this feature, see "Enabling iKVM Access to the Dell CMC Console" on page 38.

To access the **Main** dialog box:

Press <Print Screen> to launch the OSCAR interface. The **Main** dialog box is displayed.

or

If a password has been assigned, the **Password** dialog box is displayed. Type your password and click **OK**. The **Main** dialog box is displayed.

### **Resynchronizing the Server List at the Remote Client Workstation**

Once the iKVM module is connected, the blades appear in OSCAR. You now need to resynchronize the servers on any remote workstation to ensure that the blades are available to any remote users connected to the console switch through the Remote Console Switch software.



**NOTE:** This procedure only resynchronizes one remote client workstation. With multiple client workstations, save the resynchronized local database and load it into the other client workstations to ensure consistency.

To resynchronize the server listing:

- 1 Click **Resync** in the **Server** category of the Management Panel (MP).  
The Resync Wizard launches.

- 2 Click **Next**.

A warning message appears indicating that the database will be updated to match the current configuration of the console switch. Your current local database names will be overwritten with the switch names. To include unpowered SIPs in the resynchronization, click to enable the **Include Offline SIPs** check box.

- 3 Click **Next**.

A **Polling Remote Console Switch** message box appears with a progress bar indicating that the switch information is being retrieved.

- 4 If no changes were detected in the appliance, a completion dialog box appears with this information.

If server changes were detected, then the **Detected Changes** dialog box is displayed. Click **Next** to update the database.

- 5 If a cascade switch was detected, the **Enter Cascade Switch Information** dialog box is displayed.

- 6 Select the type of switch connected to the appliance from the drop-down list. If the type you are looking for is not available, you can add it by clicking **Add**.
- 7 Click **Next**. The completion dialog box is displayed.
- 8 Click **Finish** to exit.
- 9 Start up the analog switch and the system.

## FlexAddress

The FlexAddress feature is an optional upgrade introduced in CMC 1.1 that allows server modules to replace the factory assigned World Wide Name and Media Access Control (WWN/MAC) network IDs with WWN/MAC IDs provided by the chassis.

Every server module is assigned unique WWN and MAC IDs as part of the manufacturing process. Before the FlexAddress feature was introduced, if you had to replace one server module with another, the WWN/MAC IDs would change and Ethernet network management tools and SAN resources would need to be reconfigured to be aware of the new server module.


FlexAddress allows the CMC to assign WWN/MAC IDs to a particular slot and *override* the factory IDs. If the server module is replaced, the slot-based WWN/MAC ID remains the same. This feature eliminates the need to reconfigure Ethernet network management tools and SAN resources for a new server module.

Additionally, the *override* action only occurs when a server module is inserted in a FlexAddress enabled chassis; no permanent changes are made to the server module. If a server module is moved to a chassis that does not support FlexAddress, the factory assigned WWN/MAC IDs are used.

Prior to installing FlexAddress, you can determine the range of MAC addresses contained on a FlexAddress feature card by inserting the SD card into an USB Memory Card Reader and viewing the file `pwwn_mac.xml`. This clear text XML file on the SD card contains an XML tag `mac_start`, which is the first starting hex MAC address that will be used for this unique MAC address range. The `mac_count` tag is the total number of MAC addresses that the SD card allocates. The total MAC range allocated can be determined by:

$$\langle \text{mac\_start} \rangle + 0xCF (208 - 1) = \text{mac\_end}$$

For example:(starting\_mac)00188BFFDCFA + 0xCF =  
 (ending\_mac)00188BFFDDC9


 **NOTE:** You must lock the SD card prior to inserting in the USB "Memory Card Reader" to prevent accidentally modifying any of the contents. You *must unlock* the SD card before inserting into the CMC.

### FlexAddress Plus

The FlexAddress Plus is a new feature added to the feature card version 2.0. FlexAddress Plus expands the number of MAC addresses to 3136 from the original FlexAddress pool of 208.

### Activating FlexAddress

FlexAddress is delivered on a Secure Digital (SD) card that must be inserted into the CMC to provide the chassis-assigned WWN/MAC IDs. To activate the FlexAddress feature, perform several required updates; **if you are not activating FlexAddress, these updates are not required.** The updates, which are listed in the following table, include server module BIOS, I/O mezzanine BIOS or firmware, and CMC firmware. You must apply these updates before you enable FlexAddress. If these updates are not applied, the FlexAddress feature may not function as expected.

 **NOTE:** All systems purchased after June 2008 have the correct firmware versions installed.

Component	Minimum Required Version
Ethernet mezzanine card - Broadcom M5708t	Boot code firmware 4.4.1 or later iSCSI boot firmware 2.7.11 or later PXE firmware 4.4.3 or later
FC mezzanine card - QLogic QME2472	BIOS 2.04 or later
FC mezzanine card - Emulex LPe1105-M4	BIOS 3.03a3 and firmware 2.72A2 or later
Server Module BIOS	(PowerEdge M600) BIOS 2.02 or later (PowerEdge M605) BIOS 2.03 or later
PowerEdge M600/M605 LAN on motherboard (LOM)	Boot code firmware 4.4.1 or later iSCSI boot firmware 2.7.11 or later
iDRAC	Version 1.11 or later

Component	Minimum Required Version
CMC	Version 1.10 or later



**NOTE:** Components not appearing in the above table require no updates to enable the FlexAddress feature.

### Activating FlexAddress Plus

FlexAddress Plus is delivered on the FlexAddress Plus Secure Digital (SD) card along with the FlexAddress feature.



**NOTE:** The SD card labeled FlexAddress only contains FlexAddress and the card labeled FlexAddress Plus contains FlexAddress and FlexAddress Plus. The card must be inserted into the CMC to activate the feature.

The updates, which are listed in the table below include, BIOS, iDRAC, and CMC firmware. As long as FlexAddress is activated, you must apply these updates before you can use FlexAddress Plus. If these updates are not applied, only FlexAddress works and not FlexAddress Plus.

Component	Minimum required version
Server Module BIOS	PowerEdge M710HD
iDRAC	Version 3.0 or later
CMC	Version 3.0 or later

For more information on the FlexAddress feature, see the following resources:

- The CMC *Secure Digital (SD) Card Technical Specification* document at [support.dell.com](http://support.dell.com).
- The **Help** link in the CMC Web interface.
- The "Using FlexAddress" chapter in the CMC *User's Guide*.

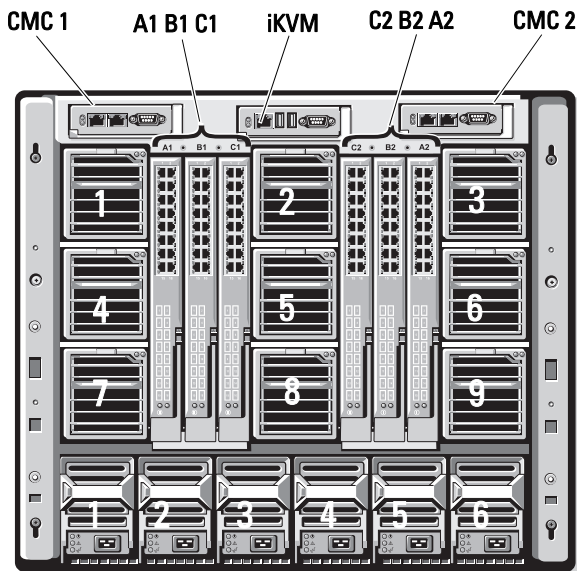


# Configuring the I/O Modules

## Overview


The M1000e enclosure supports three layers of I/O fabric. Each layer may contain Ethernet, Infiniband, and Fibre Channel modules. Additional fabrics may be supported in the future. You can install up to six hot-swappable I/O modules in the enclosure, including Fibre Channel switches, Fibre-Channel pass-throughs, Infiniband switches, Ethernet switches, and Ethernet pass-through modules. Figure 3-1 shows the numbering of the I/O bays and other back-panel features.

**Figure 3-1. I/O Module Bay Numbering**



## Fabric A


Fabric A is a redundant Gb Ethernet fabric, supporting I/O module slots A1 and A2. The integrated Ethernet controllers in each blade dictate Fabric A as an Ethernet-only fabric.

 **NOTE:** Fabric A supports KR (10 Gbps standard) if the midplane version in the enclosure is 1.1 or later. To identify the midplane version, see "Identifying Midplane Version" on page 49.

 **NOTE:** Modules designed specifically for Fabric B or Fabric C cannot be installed in slots A1 or A2, as indicated by the color-coded label on the faceplate of each module.

## Fabric B

Fabric B is a 1 to 40 Gb/sec redundant fabric, supporting I/O module slots B1 and B2. Fabric B currently supports 1 Gb or 10 Gb Ethernet, DDR/QDR Infiniband, and 4 Gbps or 8 Gbps Fibre Channel modules. Additional fabric types may be supported in the future.


 **NOTE:** Fabric B supports up to 16 Gbps Fibre Channel, Infiniband FDR (14 Gbps standard), and KR (10 Gbps standard) if the midplane version in the enclosure is 1.1 or later. To identify the midplane version, see "Identifying Midplane Version" on page 49.

To communicate with an I/O module in the Fabric B slots, a blade must have a matching mezzanine card installed in a Fabric B mezzanine card location.

Modules designed for Fabric A may also be installed in the Fabric B slots.

## Fabric C

Fabric C is a 1 to 40 Gb/sec redundant fabric, supporting I/O module slots C1 and C2. Fabric C currently supports 1 Gb or 10 Gb Ethernet, DDR/QDR Infiniband, and 4 Gbps or 8 Gbps Fibre Channel modules. Additional fabric types may be supported in the future.

 **NOTE:** Fabric C supports up to 16 Gbps Fibre Channel, Infiniband FDR (14 Gbps standard), and KR (10 Gbps standard) if the midplane version in the enclosure is 1.1 or later. To identify the midplane version, see "Identifying Midplane Version" on page 49.

To communicate with an I/O module in the Fabric C slots, a blade must have a matching mezzanine card installed in a Fabric C mezzanine card location.

Modules designed for Fabric A may also be installed in the Fabric C slots.







For more information about I/O module installation guidelines, see your *Hardware Owner's Manual*.

## Identifying Midplane Version

The version of the midplane installed in the enclosure is displayed in the **Midplane Revision** field under the **Summary** tab of the CMC web-based interface.

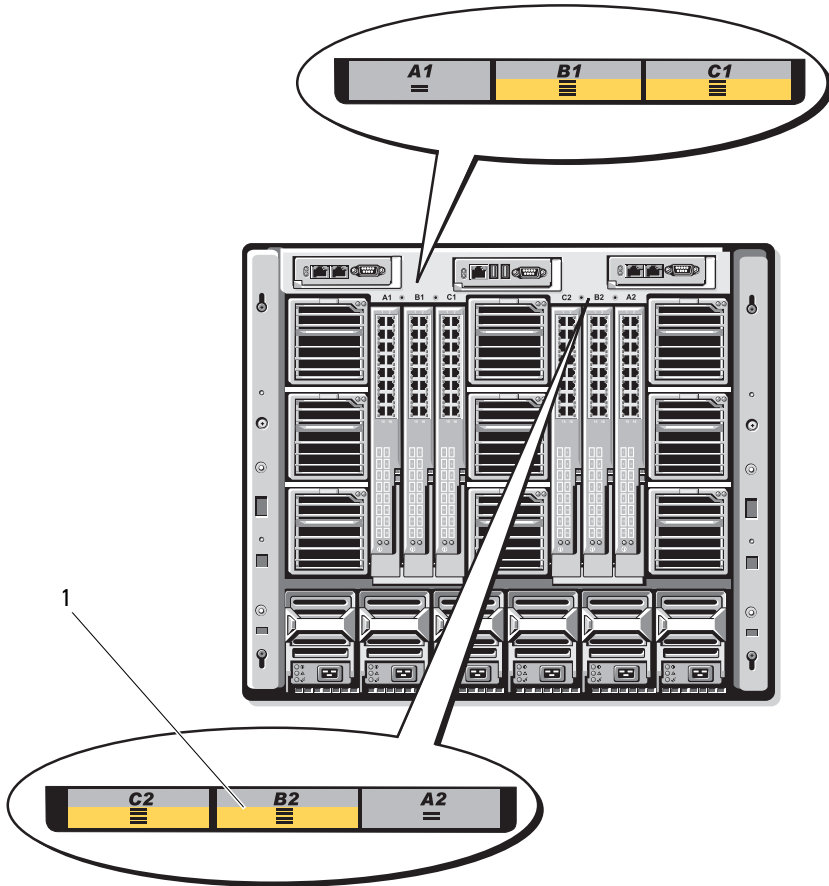
You can also view the icons at the back of the enclosure to identify the version of the midplane. See Table 3-1.

**Table 3-1. Identifying Midplane Version**

Marking	Description	Midplane Version
	I/O module slots A1, A2	1.1
	I/O module slots B1, B2, C1, and C2	1.1
	I/O module slots A1, A2	1.0
	I/O module slots B1, B2, C1, and C2	1.0

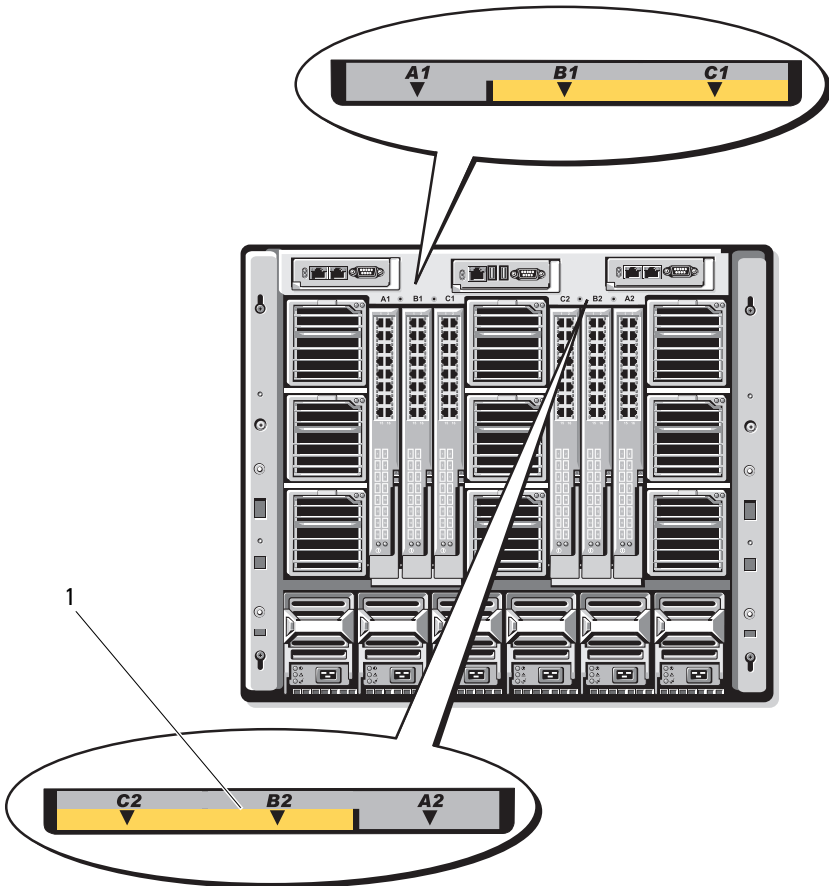
See Figure 3-2 and Figure 3-3 to locate the midplane identification labels on the enclosure.

**Figure 3-2. Identifying Midplane Version 1.1**



1 midplane identification labels (2)

**Figure 3-3. Identifying Midplane Version 1.0**



- 1 midplane identification labels (2)

# Before You Begin

## Network Information

You can configure your I/O switch modules using:

- The CMC (see "Configuring a Switch Module Network Ethernet Port Using the Web-Based Interface" on page 52).



**NOTE:** The default IP address for the CMC is 192.168.0.120.

- The CMC CLI using serial console redirection.
- Direct access to the I/O module's serial port (if supported).
- The I/O module's default IP address (if supported).

## Switch Modules

### Configuring a Switch Module Network Ethernet Port Using the Web-Based Interface

You can use the CMC Web-based interface to configure an I/O module's Ethernet port.



**NOTE:** Use this procedure to configure the switch's out-of-band Ethernet port. The switch's in-band management IP address is configured through the switch's external ports. These two IP addresses must be different, and on different networks.



**NOTE:** To change settings on the I/O module configuration page, you must have **Fabric Administrator** privileges for the particular Fabric in which the module is installed.



**NOTE:** The network IP address set on the I/O module by the CMC is not saved to a configuration file. To save the IP address configuration permanently, use the `connect switch-n RACADM` command, or use a direct interface to the I/O module GUI.



**NOTE:** Do not attempt to configure I/O module network settings for Ethernet pass-through or Infiniband switches.

- 1 Log in to the CMC's Web-based interface. See "Logging in to the CMC Using the Web-Based Interface" on page 31.
- 2 Select **I/O Modules** in the **Chassis** menu in the system tree.

- 3** Select the **Setup** tab. The **Configuring I/O Modules Network Settings** page is displayed.
- 4** Configure the switch for integration into your network.
  - Select **DHCP Mode Enabled** if your network uses a DHCP server to assign IP addresses.
  - If your network uses static IP addressing, enter an IP address, subnet mask and gateway.
- 5** When you have finished, click **Apply**.
- 6** Click the **Deploy** sub-tab.

After all I/O modules have been configured and connected, the enclosure's blades can be inserted and booted with full network communication.

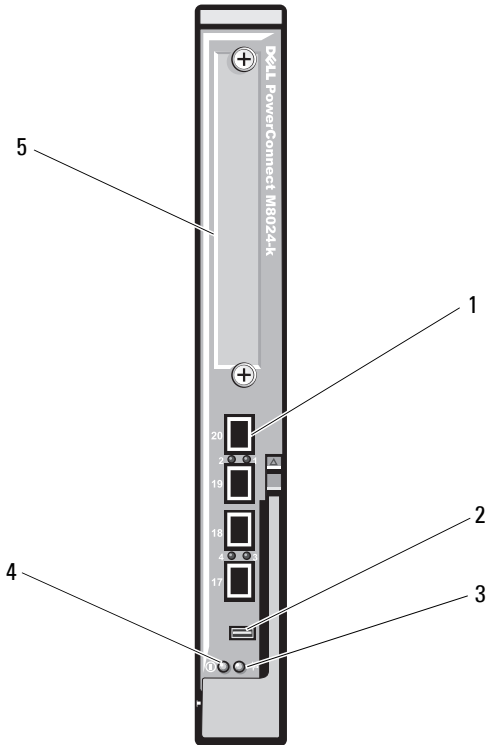
### **Dell PowerConnect-KR 8024-k Switch**

The PowerConnect M8024-k switch provides 16 internal 10 GbE ports, four external 10 GbE SFP+ ports, and one 10 GbE expansion slot for 10 GbE external uplinks. The expansion slot on the front panel can support:

- A 10 Gb Ethernet module with four optical SFP+ connectors
- A 10 Gb Ethernet module with three copper CX4 uplinks
- A 10 Gb Ethernet module with two copper 10GBASE-T uplinks

This module is hot-swappable and may be installed in Fabric A, B, or C.

**Figure 3-4. Dell PowerConnect-KR 8024-k Switch**



- |   |                                 |   |                              |
|---|---------------------------------|---|------------------------------|
| 1 | SFP+ ports (4)                  | 2 | console management connector |
| 3 | status/identification indicator | 4 | power indicator              |
| 5 | expansion slot                  |   |                              |

## Dell M8428-k 10 Gb Converged Network Switch

The Dell M8428-k 10 Gb Converged Network switch module supports FCoE protocols and allows Fibre Channel traffic to travel over 10 Gbps Enhanced Ethernet (DCB) networks. This module consists of:

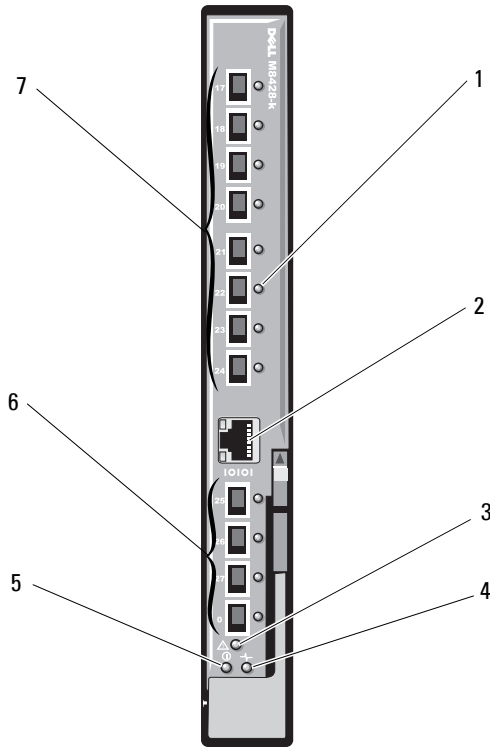
- Four 8 Gbps external autosensing Fibre Channel ports.
- Eight 10 Gb Enhanced Ethernet (DCB) optical SFP+ port connectors.
- Sixteen internal 10 Gb Enhanced Ethernet (DCB/FCoE) ports that link to the blades in the enclosure.
- One serial port with an RJ-45 connector.



**NOTE:** This switch module includes Short Wave Small Form Factor Pluggable (SFP) optical transceivers in the Fibre Channel ports. To ensure proper Fibre Channel functionality, use only SFPs provided with this module.

This module can be installed in Fabric A, B, or C.

**Figure 3-5. Dell M8428-k 10 Gb Converged Network Switch**



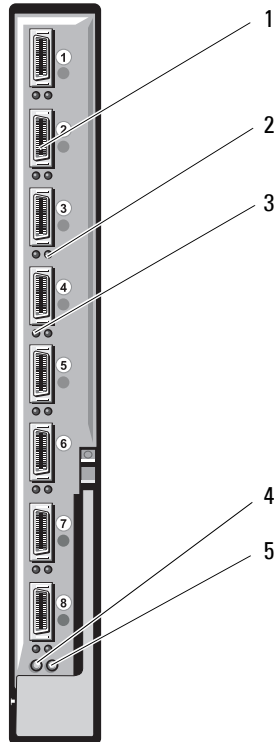
- |   |                             |   |   |
|---|-----------------------------|---|---|
| 1 | LED status indicators (12)  | 2 | serial port (RJ-45 connector)                     |
| 3 | module status indicator     | 4 | status indicator                                  |
| 5 | power indicator             | 6 | 8 Gb Fibre Channel ports (ports 25–27 and port 0) |
| 7 | 10 GbEE ports (ports 17–24) |   |   |



## Mellanox M2401G DDR Infiniband Switch I/O Module

The Mellanox M2401G Infiniband switch I/O module includes 24 4x DDR Infiniband ports. Eight ports are external uplink ports, while 16 internal ports provide connectivity to the blades in the enclosure.

**Figure 3-6. Mellanox M2401G Infiniband Switch Module**

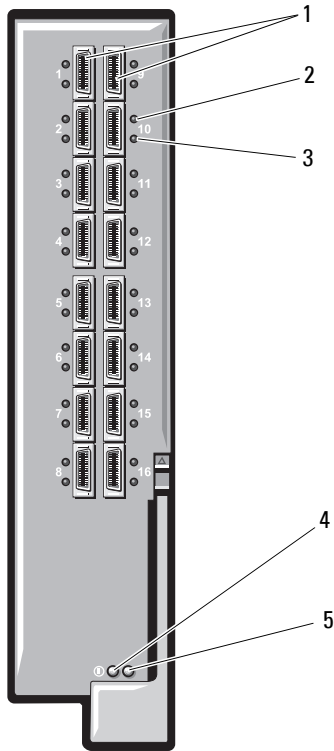


- |   |                              |   |                                   |
|---|------------------------------|---|-----------------------------------|
| 1 | Infiniband ports (8)         | 2 | port link status indicators (8)   |
| 3 | port activity indicators (8) | 4 | module diagnostic power indicator |
| 5 | module status indicator      |   |                                   |

## **Mellanox M3601Q QDR Infiniband Switch I/O Module**

The Mellanox M3601 Infiniband switch I/O module includes 32 4x QDR Infiniband ports. Of these, 16 ports are external uplink ports, while 16 internal ports provide connectivity to the blades in the enclosure. This module occupies two I/O module slots. By default, the M3610Q module plugs into I/O module slot C1, but occupies both slots B1 and C1. It can also be plugged into I/O module slot B1 (occupying slots A1 and B1) or slot B2 (occupying slots B2 and C2).

**Figure 3-7. Mellanox M3601Q Infiniband Switch Module**



- |   |                               |   |                                   |
|---|-------------------------------|---|-----------------------------------|
| 1 | Infiniband ports (16)         | 2 | port link status indicators (16)  |
| 3 | port activity indicators (16) | 4 | module diagnostic power indicator |
| 5 | module status indicator       |   |                                   |

## Cisco SFS M7000e Infiniband Switch I/O Module

The Cisco SFS M7000e Infiniband switch module includes 24 4x DDR Infiniband ports. Eight ports are external uplink ports, and 16 internal ports provide connectivity to the blades in the enclosure. This switch module is hot-swappable, and may be installed in Fabric B or Fabric C.

**Figure 3-8. Cisco SFS M7000e Infiniband Switch Module Features**



- |   |                             |   |                           |
|---|-----------------------------|---|---------------------------|
| 1 | Infiniband ports (8)        | 2 | port status indicator (8) |
| 3 | diagnostic status indicator | 4 | power indicator           |

## Cisco Catalyst Ethernet Switch I/O Modules

Your system supports three Cisco Catalyst Blade Switch (CBS) versions:

- The Cisco 3130G-S switch includes four 10/100/1000 Mb Ethernet uplink ports and two Stackwise Plus ports.
- The Cisco CBS 3130X-S switch includes four 10/100/1000 Mb Ethernet uplink ports, two 10 Gb uplink ports, and two Stackwise Plus ports.
- The Cisco CBS 3032 switch includes four 10/100/1000 Mb Ethernet uplink ports.

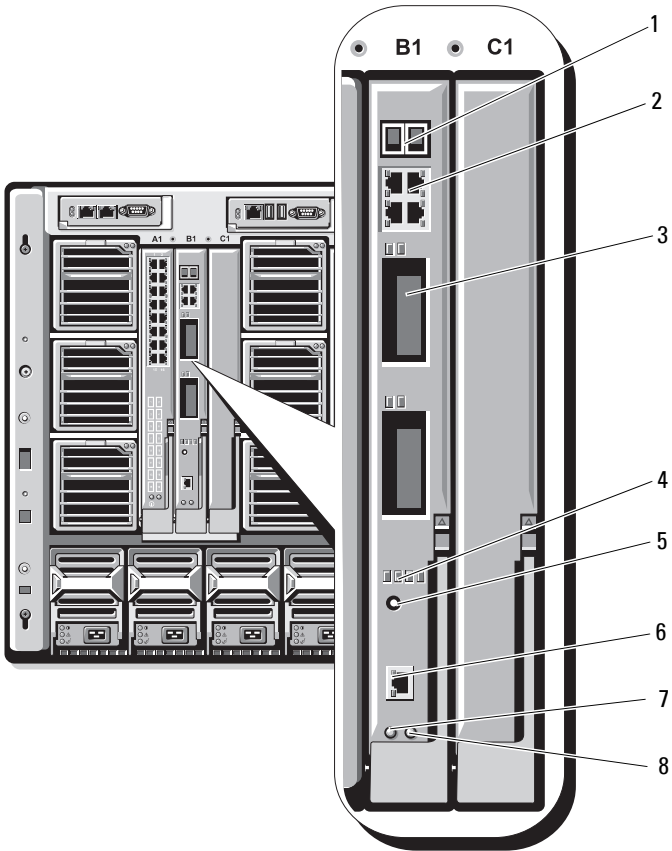
The two option bays support the following module options:

- Cisco X2 10 Gb transceiver modules (CBS 3130X-S only)
- Cisco TwinGig converter modules

All three switches include an RJ-45 console connector for switch management. Sixteen internal Gb Ethernet connectors link to the blades in the enclosure.

For additional information about the Cisco CBS Ethernet switch modules, see the documentation that shipped with the module.

**Figure 3-9. Cisco Catalyst Ethernet Switch Module Features**



- |   |   |
|---|---|
| <p>1 Stackwise Plus connectors (not enabled in CBS 3032)</p> <p>3 option bays (2)</p> <p>5 mode button</p> <p>7 power indicator</p> | <p>2 10/100/1000 Mb Ethernet connectors (4)</p> <p>4 Cisco status indicators</p> <p>6 console port for switch management</p> <p>8 status/identification indicator</p> |
|---|---|

## **PowerConnect M6220 Ethernet Switch I/O Module**

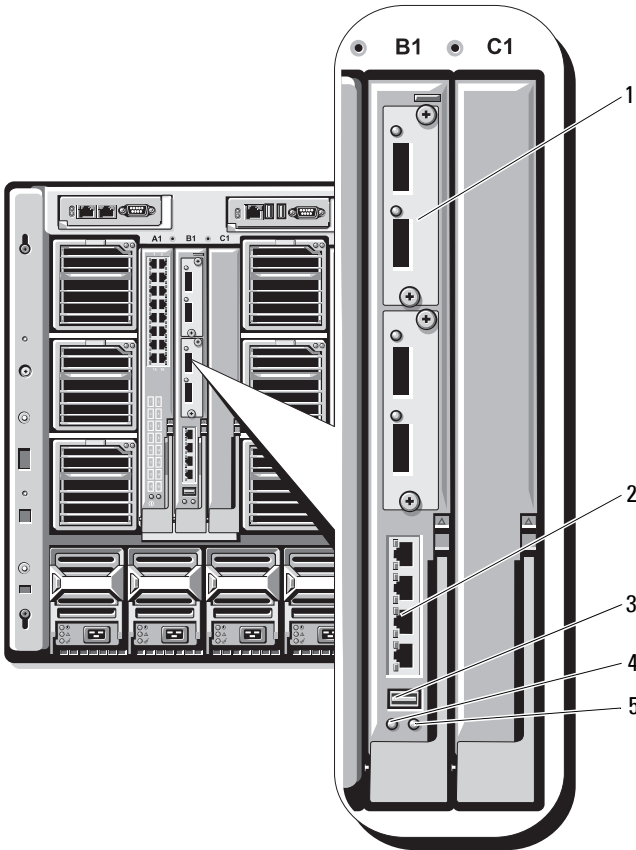
The PowerConnect M6220 Ethernet switch module includes four external 10/100/1000 Mbps Ethernet connectors and one USB type A form factor serial connector. Two option bays support the following modules:

- A resilient stacking module with 2 x 24 Gb stacking ports
- A 10 Gb Ethernet module with two 10 Gb optical XFP uplinks
- A 10 Gb Ethernet module with two copper CX4 uplinks
- A 10 Gb Ethernet module with two copper 10GBASE-T uplinks
- A 10 Gb Ethernet module with two SFP+ (optical or direct-attach copper) uplinks

Installing two optional modules provides additional stacking and redundancy support. Sixteen internal Gb Ethernet connectors link to the blades in the enclosure.

For additional information about the PowerConnect M6220 Ethernet switch module, see the documentation that shipped with the module.

**Figure 3-10. PowerConnect M6220 Ethernet Switch Module Features**



- |   |   |   |   |
|---|---|---|---|
| 1 | optional module (2) (dual 10 Gb Ethernet uplink module shown) | 2 | standard 10/100/1000 Mb Ethernet connectors (4) |
| 3 | serial connector (USB type-A form factor)                     | 4 | power indicator                                 |
| 5 | status/identification indicator                               |   |   |



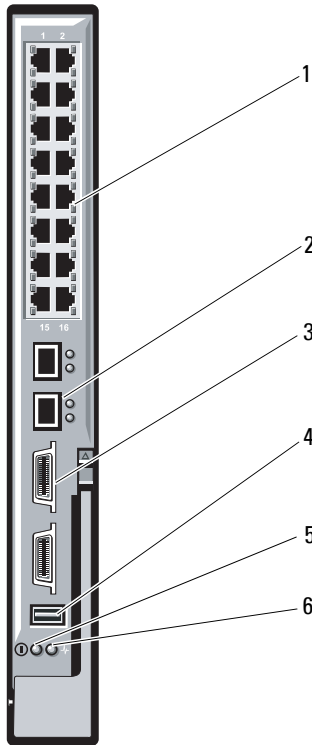
## **PowerConnect M6348 1 Gb Ethernet Switch I/O Module**

The PowerConnect M6348 is a hot-swappable 48-port 1 Gb Ethernet switch. While 16 ports are external uplink ports, the remaining 32 internal ports provide connectivity to the blades within the enclosure with a maximum bandwidth of 1 Gbps each. The PowerConnect M6348 switch also supports:

- Two integrated 10 Gb Ethernet SFP+ connectors
- Two integrated CX4 connectors for stacking or 10 Gb uplinks
- One console management connector

It is recommended that you use the PowerConnect M6348 switch with quad-port mezzanine cards for maximum functionality. The quad-port mezzanine cards and the PowerConnect M6348 Ethernet switch enable an increased bandwidth (two 1 Gbps lanes), higher port density, and server module consolidation.

**Figure 3-11. PowerConnect M6348 Switch Module**



- |   |  |   |                                 |
|---|--|---|---------------------------------|
| 1 | standard 10/100/1000 Mb Ethernet connectors (16) | 2 | SFP+ connectors (2)             |
| 3 | CX4 stacking connectors (2)                      | 4 | console management connector    |
| 5 | power indicator                                  | 6 | status/identification indicator |

## PowerConnect M8024 10 Gb Ethernet Switch I/O Module

The PowerConnect M8024 switch module incorporates two optional bays that support the following modules:

- A 10 Gb Ethernet module with four optical SFP+ connectors
- A 10 Gb Ethernet module with three copper CX4 uplinks
- A 10 Gb Ethernet module with two copper 10GBASE-T uplinks

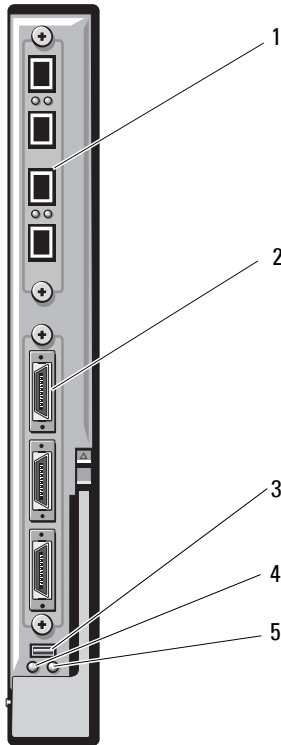
The modules can be used in any combination and are sold separately.

You can initially configure the switch using either of two methods:

- Connect an external management system to the switch using an optional USB type-A form factor serial cable, and configure the switch using a terminal application.
- Use the iKVM CMC console (“17th blade”) and the **connect switch-n** CMC CLI command. For more information, see the *CMC User’s Guide*.

Once an IP address is assigned to the management VLAN or interface and the switch is connected to a management network, both Telnet and http are available through the network.

**Figure 3-12. PowerConnect M8024 Switch Module**



- |   |  |   |                                      |
|---|--|---|--------------------------------------|
| 1 | optional module with four SFP+ ports                       | 2 | optional module with three CX4 ports |
| 3 | serial connector for optional USB type-A form-factor cable | 4 | power indicator                      |
| 5 | status/identification indicator                            |   |                                      |

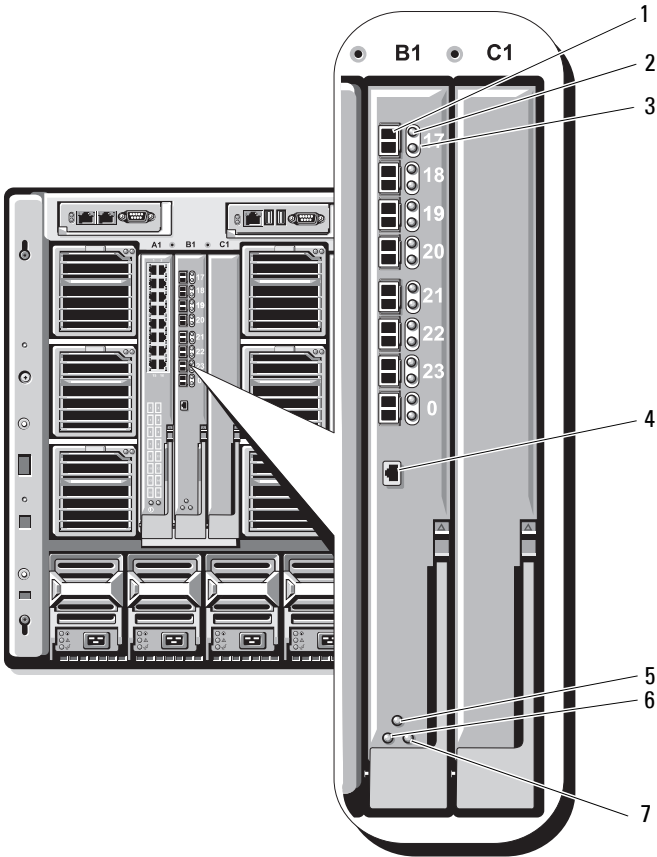
## Brocade M4424 SAN I/O Module

The Brocade M4424 SAN I/O module includes eight external autosensing Fibre Channel ports (four ports are enabled in the standard configuration and four additional ports may be enabled as an optional upgrade), 16 internal ports, and one serial port with an RJ-45 connector. The external Fibre Channel ports operate at 1 Gb/sec, 2 Gb/sec, or 4 Gb/sec. The Fibre Channel switch module is hot-swappable, and may be installed in Fabric B or Fabric C.



**NOTE:** The Fibre Channel switch module includes Short Wave Small Form Factor Pluggable (SFP) optical transceivers. To ensure proper functionality, use only SFPs provided with this module.

**Figure 3-13. Brocade M4424 SAN I/O Module**



- |   |  |   |   |
|---|--|---|---|
| 1 | Fibre Channel port (8)                 | 2 | Fibre Channel port status indicator (8) |
| 3 | Fibre Channel port speed indicator (8) | 4 | serial port (RJ-45 connector)           |
| 5 | module status indicator                | 6 | power indicator                         |
| 7 | status/identification indicator        |   |   |

## Brocade M5424 FC8 I/O Module

The Brocade M5424 I/O module includes eight external autosensing Fibre Channel ports (four ports are enabled in the standard configuration and four additional ports may be enabled as an optional upgrade), 16 internal ports, and one serial port with an RJ-45 connector. The external Fibre Channel ports operate at 8 Gb/sec, 4 Gb/sec, or 2 Gb/sec.

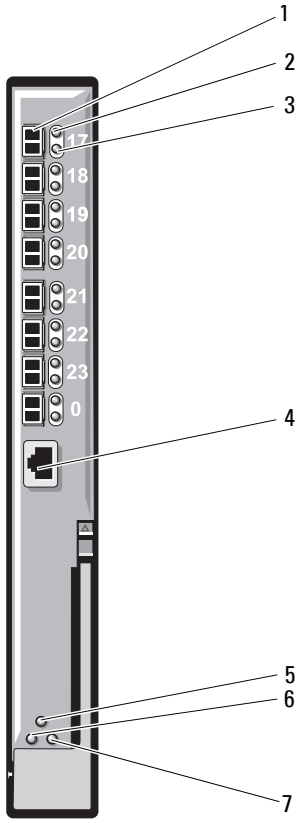


**NOTE:** CMC firmware version 1.3 is required to support FC8 mezzanine cards and I/O modules.



**NOTE:** This Fibre Channel switch module includes Short Wave Small Form Factor Pluggable (SFP) optical transceivers. To ensure proper functionality, use only SFPs provided with this module.

**Figure 3-14. Brocade M5424 FC8 I/O Module**



- |  |   |
|--|---|
| <ul style="list-style-type: none"> <li>1 Fibre Channel port (8)</li> <li>3 Fibre Channel port speed indicator (8)</li> <li>5 module status indicator</li> <li>7 status/identification indicator</li> </ul> | <ul style="list-style-type: none"> <li>2 Fibre Channel port status indicator (8)</li> <li>4 serial port (RJ-45 connector)</li> <li>6 power indicator</li> </ul> |
|--|---|



## Dell 8/4 Gbps FC SAN Module

The Dell 8/4 Gbps FC SAN module (see Figure 3-15) includes 24 total autosensing Fibre Channel ports (12 ports are enabled in the standard configuration and 12 additional ports may be enabled as an optional upgrade) and one serial port with an RJ-45 connector. The internal Fibre Channel ports operate at 8 Gb/sec or 4 Gb/sec. The external Fibre Channel ports operate at 8 Gb/sec, 4 Gb/sec, or 2 Gb/sec.

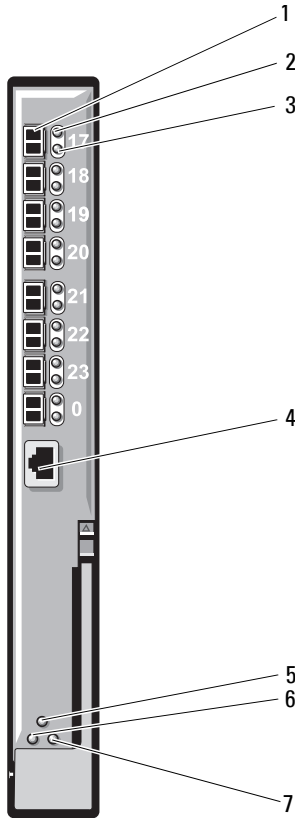


**NOTE:** CMC firmware version 1.3 is required to support FC8 mezzanine cards and I/O modules.



**NOTE:** This Fibre Channel switch module includes Short Wave Small Form Factor Pluggable (SFP) optical transceivers. To ensure proper functionality, use only SFPs provided with this module.

**Figure 3-15. Dell 8/4 Gbps FC SAN Module**



- |   |  |   |   |
|---|--|---|---|
| 1 | Fibre Channel port (8)                 | 2 | Fibre Channel port status indicator (8) |
| 3 | Fibre Channel port speed indicator (8) | 4 | serial port (RJ-45 connector)           |
| 5 | module status indicator                | 6 | power indicator                         |
| 7 | status/identification indicator        |   |   |

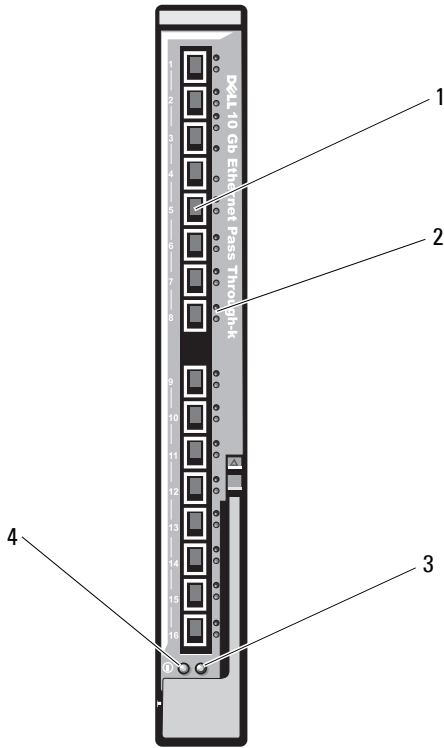
# Pass-Through Modules

## **Dell 10 GbE KR Pass-Through I/O Module**

The 10 GbE KR pass-through module supports 10 Gb connections and provides a direct connection between the optional internal Ethernet KR mezzanine card or KR network daughter card in the blade and an external Ethernet device. This module has 16 external SFP+ ports on the front panel and sixteen 10 GbE KR internal ports through the backplane. This module enables you to use optical SFP+ (short reach or long reach) and direct-attached copper (DCA) SFP+ modules.

The Ethernet pass-through module is hot-swappable and may be installed in Fabric A, B, or C. The pass-through module does not support 1G mezzanine or network daughter cards in blades.

**Figure 3-16. Dell 10 GbE KR Pass-Through I/O Module**



- |   |                                 |   |                                       |
|---|---------------------------------|---|---------------------------------------|
| 1 | SFP+ ports (16)                 | 2 | green/amber indicators (two per port) |
| 3 | status/identification indicator | 4 | power indicator                       |

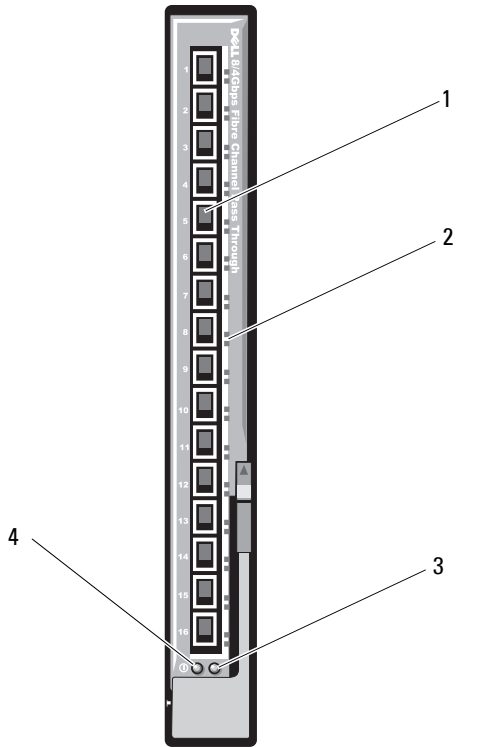
## Dell 8/4 Gbps Fibre Channel Pass-Through I/O Module

The 8G Fibre Channel pass-through module provides a bypass connection between a Fibre Channel mezzanine card in the blade and optical transceivers. The bypass connection enables a direct connection to a Fibre Channel switch or a storage array. The 16 pass-through ports on this module can negotiate speeds of 2, 4, and 8 Gbps. The 8G Fibre Channel pass-through module is hot-swappable and may be installed in Fabric B or Fabric C.



**NOTE:** To ensure proper functionality, use only the Short Wave Small Form Factor Pluggable (SFP) transceivers provided with this module.

**Figure 3-17. Dell 8/4 Gbps Fibre Channel Pass-Through I/O Module**



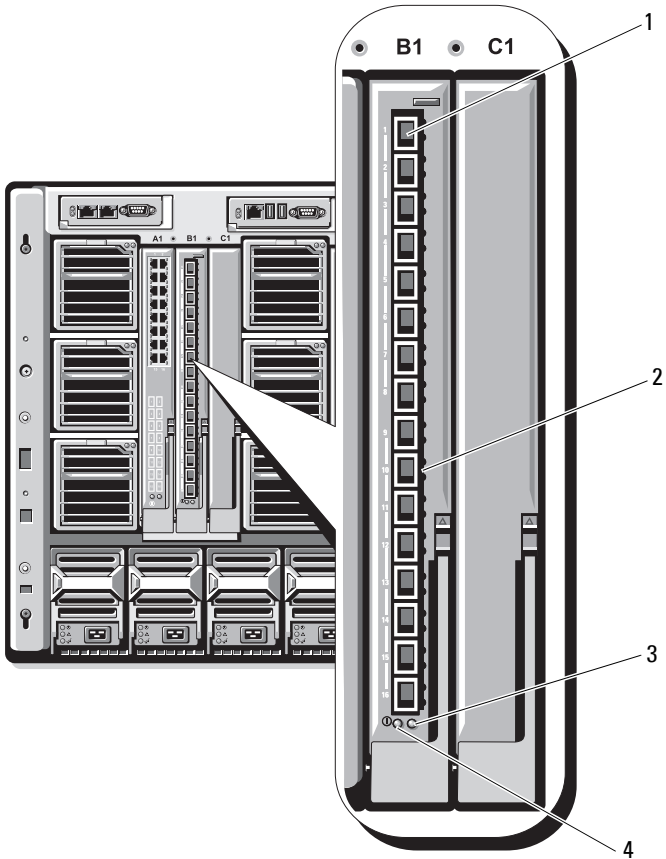
- |   |                                 |   |                        |
|---|---------------------------------|---|------------------------|
| 1 | Fibre Channel ports (16)        | 2 | port status indicators |
| 3 | status/identification indicator | 4 | power indicator        |

## **10 Gb Ethernet Pass-Through Module II**

The Dell 10 Gb Ethernet pass-through module II supports 10 Gb connections and provides a direct connection between the optional internal Ethernet mezzanine card in the blade and an external Ethernet device. The Ethernet pass-through modules are hot-swappable and may be installed in Fabric B or Fabric C.

The 10 Gb Ethernet pass-through module II enables you to use optical SFP+ (short reach or long reach) and direct-attached copper (DCA) SFP+ modules. The Ethernet pass-through module does not support 1G mezzanine or network daughter cards in blades.

**Figure 3-18. 10 Gb Ethernet Pass-Through Module II**



- |   |                                 |   |                                       |
|---|---------------------------------|---|---------------------------------------|
| 1 | SFP+ cages (16)                 | 2 | green/amber indicators (two per port) |
| 3 | status/identification indicator | 4 | power indicator                       |

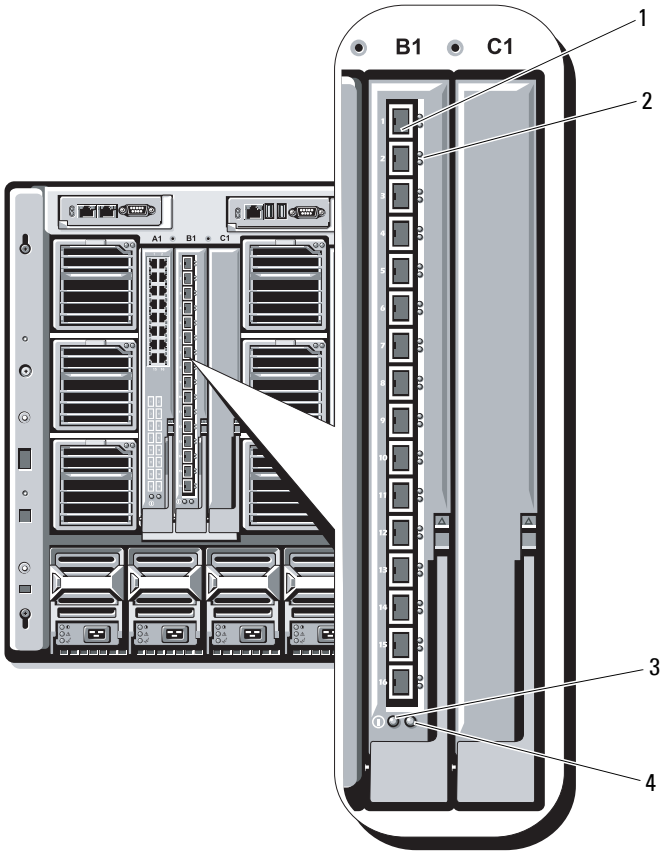


## **10 Gb Ethernet Pass-Through I/O Module**

The 10 Gb Ethernet pass-through module supports 10 Gb connections and provides a direct connection between the optional internal Ethernet mezzanine card in the blade and an external Ethernet device. The Ethernet pass-through modules are hot-swappable and may be installed in Fabric B or Fabric C.

The 10 Gb Ethernet pass-through I/O module enables you to use optical SFP, SFP+, and direct-attached copper (DCA) SFP+ modules. To operate the I/O module and the SFP+ modules at 10 Gbps, you must use either optical SFP+ short reach (SR), long reach multimode (LRM), or DCA SFP+ modules. This module does not support 1G mezzanine or network daughter cards in blades.

**Figure 3-19. 10 Gb Ethernet Pass-Through I/O Module**

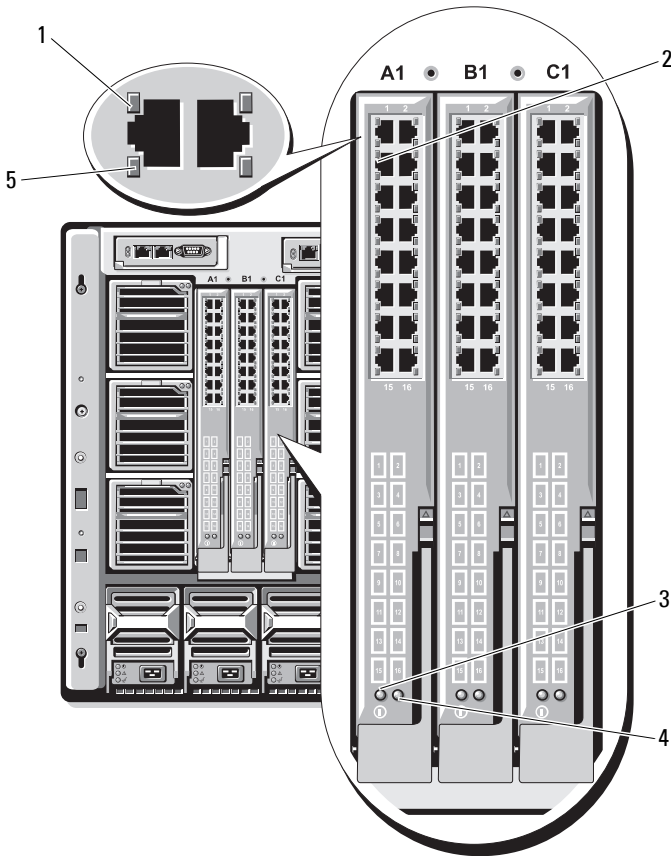


- |   |                 |   |                                       |
|---|-----------------|---|---------------------------------------|
| 1 | SFP+ cages (16) | 2 | green/amber indicators (two per port) |
| 3 | power indicator | 4 | status/identification indicator       |

## **10/100/1000 Mb Ethernet Pass-Through I/O Module**

The Ethernet pass-through module supports 10/100/1000 Mb connections and provides a direct connection between the optional internal Ethernet mezzanine card in the blade and an external Ethernet device. The Ethernet pass-through modules are hot-swappable and may be installed in any of the three Fabrics.

**Figure 3-20. Ethernet Pass-Through Module**



- |   |                         |   |                                 |
|---|-------------------------|---|---------------------------------|
| 1 | link indicator (16)     | 2 | RJ45 Ethernet connector (16)    |
| 3 | power indicator         | 4 | status/identification indicator |
| 5 | activity indicator (16) |   |                                 |

**NOTE:** Connectors on the Ethernet pass-through module correspond directly to the blade number. For example, blade 5 is connected to port 5 on the Ethernet pass-through module. Integrated network adapter 1 maps to I/O slot A1. Integrated network adapter 2 maps to I/O slot A2.

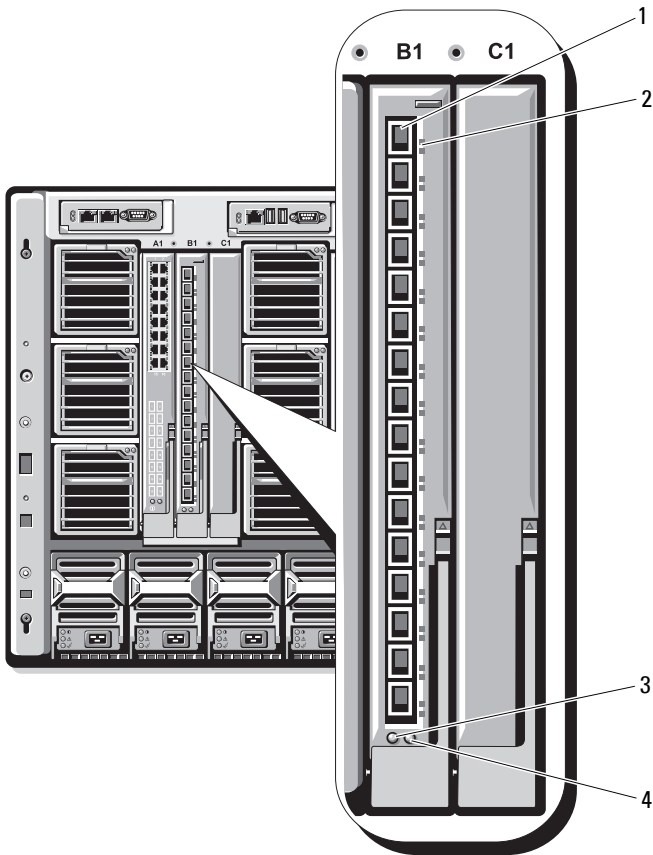
## 4G Fibre Channel Pass-Through I/O Module

The 4G Fibre Channel pass-through module provides a bypass connection between a Fibre Channel mezzanine card in the blade and optical transceivers. The bypass connection enables a direct connection to a Fibre Channel switch or a storage array. The 16 pass-through ports on this module can negotiate speeds of 1, 2, or 4 Gbps. The 4G Fibre Channel pass-through module is hot-swappable, and may be installed in Fabric B or Fabric C.



**NOTE:** To ensure proper functionality, use only the Short Wave Small Form Factor Pluggable (SFP) transceivers provided with this module.

**Figure 3-21. 4G Fibre Channel Pass-Through Module**



- |   |                                  |   |   |
|---|----------------------------------|---|---|
| 1 | SFP Fibre Channel connector (16) | 2 | Fibre Channel green/amber indicators (two per port) |
| 3 | power indicator                  | 4 | status/identification indicator                     |

## Free Manuals Download Website

<http://myh66.com>

<http://usermanuals.us>

<http://www.somanuals.com>

<http://www.4manuals.cc>

<http://www.manual-lib.com>

<http://www.404manual.com>

<http://www.luxmanual.com>

<http://aubethermostatmanual.com>

Golf course search by state

<http://golfingnear.com>

Email search by domain

<http://emailbydomain.com>

Auto manuals search

<http://auto.somanuals.com>

TV manuals search

<http://tv.somanuals.com>