

Dell SonicWALL E-Class NSA Appliances

NETWORK SECURITY

NSA E8510

Getting Started Guide



Notes, Cautions, and Warnings



NOTE: A NOTE indicates important information that helps you make better use of your system.



CAUTION: A CAUTION indicates potential damage to hardware or loss of data if instructions are not followed.



WARNING: A WARNING indicates a potential for property damage, personal injury, or death.

© 2013 Dell, Inc.

Trademarks: Dell™, the DELL logo, SonicWALL™, SonicWALL GMS™, SonicWALL Analyzer™, Reassembly-Free Deep Packet Inspection™, Dynamic Security for the Global Network™, SonicWALL SuperMassive™ Appliances, SonicWALL Dynamic Support 24x7™, SonicWALL Comprehensive Gateway Security Suite™, SonicWALL McAfee Client/Server Anti-Virus Suite™, and all other SonicWALL product and service names and slogans are trademarks of Dell, Inc.

Microsoft Windows, Internet Explorer, and Active Directory are trademarks or registered trademarks of Microsoft Corporation.

Other product and company names mentioned herein may be trademarks and/or registered trademarks of their respective companies and are the sole property of their respective manufacturers.

2013 – 02 P/N 232-001858-51 Rev. A

In this Guide

The Dell SonicWALL E-Class Network Security Appliance (NSA) E8510 is designed to be the most scalable, reliable, and best performing multifunction appliance in its class.

This Getting Started Guide provides instructions for basic installation and configuration of the Dell SonicWALL NSA E8510.

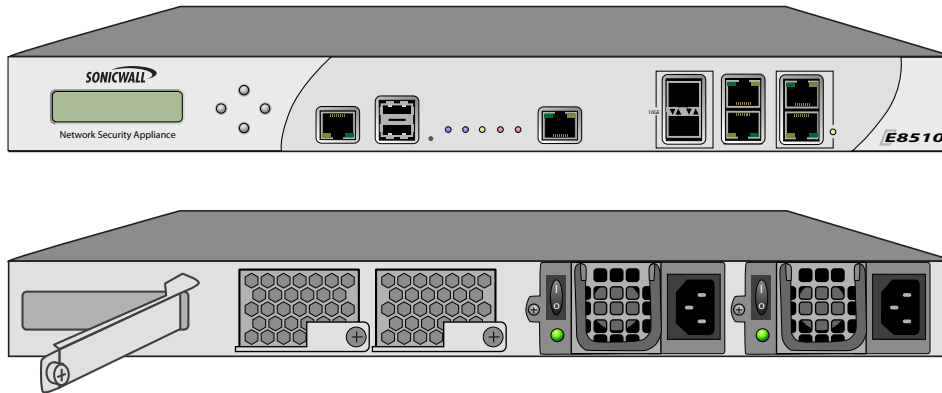

Note: Always observe proper safety and regulatory guidelines when removing administrator-serviceable parts from the Dell SonicWALL NSA E8510. Proper guidelines can be found in the [Product Safety and Regulatory Information](#) section, on page 68 of this guide.

This Getting Started Guide contains the following sections:

Chapter 1	Sections Include
Pre-Configuration Tasks - page 6	<ul style="list-style-type: none">• Dell SonicWALL NSA E8510 Package Contents - page 7• Obtain Configuration Information - page 8• The Front Panel - page 10• The Back Panel - page 11• Front Bezel Control Features - page 12• LAN IP Configuration Example - page 16
Chapter 2	Sections Include
Registering Your Appliance - page 18	<ul style="list-style-type: none">• Before You Register - page 19• Creating a MySonicWALL Account - page 20• Registering and Licensing Your Appliance on MySonicWALL - page 20
Chapter 3	Sections Include
Deployment Scenarios - page 26	<ul style="list-style-type: none">• Selecting a Deployment Scenario - page 27• Initial Setup - page 31• Configuring a Stateful HA Pair - page 38• Configuring L2 Bridge Mode - page 44

Chapter 4	Sections Include
Additional Deployment Configuration - page 46	<ul style="list-style-type: none"> • An Introduction to Zones and Interfaces - page 47 • Creating a NAT Policy - page 48 • Enabling Security Services in SonicOS - page 51 • Applying Security Services to Zones - page 52 • Troubleshooting Diagnostic Tools - page 52

Chapter 5	Sections Include
Support and Training Options - page 54	<ul style="list-style-type: none"> • Customer Support - page 55 • Knowledge Portal - page 55 • User Forums - page 56 • Training - page 57 • Related Documentation - page 58 • Dynamic Tooltips - page 59 • Dell SonicWALL Live Product Demos - page 59 • Dell SonicWALL Secure Wireless Network Integrated Solutions Guide - page 60

Chapter 6	Sections Include
Rack Mounting Instructions - page 62	<ul style="list-style-type: none"> • Rack Mounting Instructions - page 63

Chapter 7	Sections Include
Product Safety and Regulatory Information - page 68	<ul style="list-style-type: none"> • Safety and Regulatory Information - page 69 • Warranty Information - page 73 • Copyright Notice - page 73

In this Section:

This section provides pre-configuration information. Review this section before setting up your Dell SonicWALL NSA E8510.

- [Dell SonicWALL NSA E8510 Package Contents](#) - page 7
- [Obtain Configuration Information](#) - page 8
- [The Front Panel](#) - page 10
- [The Back Panel](#) - page 11
- [Front Bezel Control Features](#) - page 12
- [LAN IP Configuration Example](#) - page 16

Dell SonicWALL NSA E8510 Package Contents

Before you begin the setup process, verify that your package contains the following items:

1. One Dell SonicWALL NSA E8510 appliance
2. One serial CLI cable
3. One Ethernet cable
4. Two power cords*
5. One Rack Mounting Kit
6. One Dell SonicWALL NSA E8510 Getting Started Guide

*The included power cord(s) are approved for use only in specific countries or regions. Before using a power cord, verify that it is rated and approved for use in your location. The power cords are for AC mains installation only. Field conversion DC power cable is different, see Safety and Regulatory Information for more information.

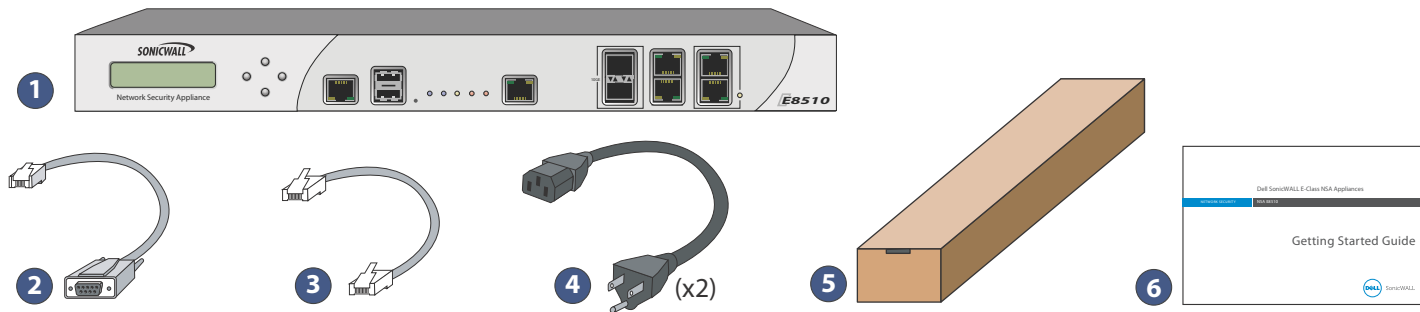

Missing Items? If any items are missing from your package, contact Dell SonicWALL Support:

Web: <http://www.sonicwall.com/us/Support.html>

Email: customer_service@sonicwall.com

Obtain Configuration Information

Please record and keep for future reference the following setup information:

Registration Information

Serial Number:	Record the serial number found on the bottom panel of your Dell SonicWALL appliance.
Authentication Code:	Record the authentication code found on the bottom panel of your Dell SonicWALL appliance.

Networking Information

LAN IP Address: _____.	Select a static IP address for your Dell SonicWALL appliance that is within the range of your local subnet. If you are unsure, you can use the default IP address (192.168.168.168).
Subnet Mask: _____.	Record the subnet mask for the local subnet where you are installing your Dell SonicWALL appliance.
Ethernet WAN IP Address: _____.	Select a static IP address for your Ethernet WAN. <i>This setting only applies if you are already using an ISP that assigns a static IP address.</i>

Administrator Information

Admin Name:	Select an administrator account name. (default is <i>admin</i>)
Admin Password:	Select an administrator password. (default is <i>password</i>)

Obtain Internet Service Provider (ISP) Information

Record the following information about your current Internet service:

If You connect using	Please record
DHCP	<i>No information is usually required.</i> Some providers may require a Host name: _____
Static IP	IP Address: _____ Subnet Mask: _____ Default Gateway: _____ Primary DNS: _____ DNS 2 (optional): _____ DNS 3 (optional): _____



Note: *If you are not using one of the network configurations above, refer to the SonicOS Administrator's Guide:*

www.sonicwall.com/us/support

The Front Panel

Console Port

Access the SonicOS Command Line Interface (CLI) via the DB9 -> RJ45 cable

Control Buttons

Navigate the LCD screen

LCD Screen

Interface to display status, make configuration changes, restart the appliance or boot into SafeMode

X2-X3 (SFP)

Hot-pluggable "small form-factor pluggable transceiver" interfaces; 10GB SFP+ connectors are required (not included)

HA Port

High Availability primary/secondary Gigabit Ethernet port

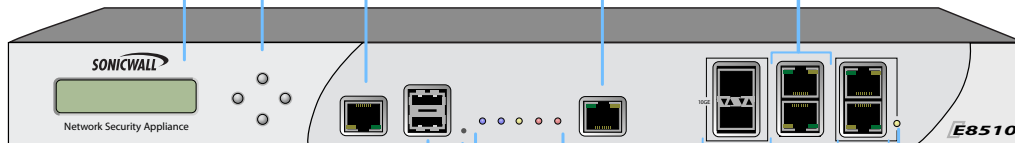

USB Ports (2)

For future feature extensions

Reset Button

Press and hold for several seconds to manually reset the appliance

LED Indicators (left to right)

Power (2): Blue: Indicates power supplies are operating correctly, Yellow: Indicates an unconnected power supply or failure
Test: Quick blinking: Initializing, Slow blinking: SafeMode
Solid: test mode.
Alarm: Alarm condition
HD: Future extension

X4-X5 (10 GE)

10-Gigabit Ethernet ports

X0-X1 (Copper)

High speed Gigabit Ethernet ports

Bypass Status LED

Lit: Indicates when fail to wire bypass mode is armed

The Back Panel

Fans (2)

Dual auto-throttling fans for system temperature control

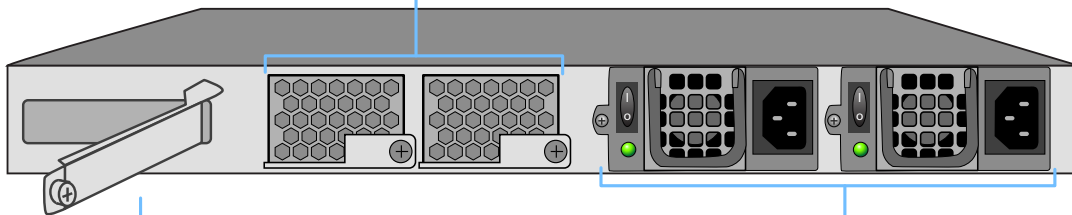

Expansion Bay

For SonicWall approved expansion modules

Power Supplies (2)

Dual power supplies for redundant AC power and added reliability
Field conversion is available to convert to DC mains
DC power supplies use different input connector and power cables



Warning: Potential Hazard from Fan





This manual contains specific warning and caution statements where they apply. Please read the Safety Instructions before use! See the [Product Safety and Regulatory Information](#) on page 68.

Front Bezel Control Features

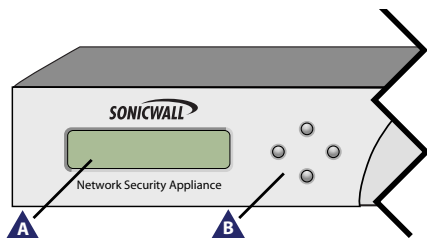
The Dell SonicWALL NSA E8510 is equipped with a front panel bezel interface that allows an administrator to customize certain aspects of the appliance or simply monitor its status without having to log into it through a separate terminal.



Icon	Feature	Description
	LCD Screen	Displays the front panel bezel interface which can be used to display status information, perform basic configurations, restart the appliance or boot the appliance in SafeMode.
	Control Buttons	Up, Down, Left and Right buttons, used to navigate the LCD menu system.



Note: Using the front bezel for configuration purposes prior to completing initial setup will bypass the Setup Wizard's automatic launch at startup.

LCD Control Buttons

The LCD interface is controlled by a D-pad, consisting of four buttons: **up, down, left, right**. The table below describes the functions of the buttons:

Button	Navigation Features
Up/Down	Selects options and navigates up and down lists.
Left	Cancels changes and returns to the previous menu.
Right	Confirms choices and enters menus. Also sets the appliance to screen-saver mode when used from the main menu.

Main Menu

Upon booting the LCD display will initially show the Main Menu. The menu is made up of four options:

Status	Contains basic status values including system resources, connections and port configuration values.
Configure	Allows configuration of basic system values including X0 (LAN) and X1 (WAN) port configuration. Requires system PIN for access, default: 76642 .
Restart	Provides the ability to restart the appliance. Requires system PIN for access.
Safe Mode	Provides the ability to restart and boot the appliance into SafeMode. Requires system PIN for access.

Use the **Up** and **Down** button to select the menu you wish to enter and click the **Right** button to enter it.

Status

The Status menu allows you to view specific aspects of the appliance. Once selected, the LCD displays the Status List. This list is navigated using the **Up** and **Down** buttons. Status options available include:

- Appliance serial number
- Firmware / ROM versions
- Appliance name
- Date and Time
- Uptime
- CPU statistical readings
- Current number of connections
- Interface (X0, X1) network settings
- Interface (X0, X1) data transfer statistics

The **X1 DNS1-3** entries will only be displayed if they have been set from the Configure menu. If their value is still 0.0.0.0 (default value), they will not appear in the Status List.

Configure

The Configure Menu allows you to configure specific aspects of the appliance. Once selected, the LCD will display a PIN request.



Note: *The Default PIN is **76642**. This number spells SONIC on a phone keypad. The PIN number can be changed from the **System > Administration** page.*

All numbers are inputted using the 4 buttons. Select the individual digit field using the **Left** and **Right** button and select the desired number using the **Up** and **Down** Button. Digits increase incrementally from 0 to 9. Press the **Right** button to confirm your PIN and enter the Configuration Menu.

The appliance allows the user to navigate in and out of the Configuration Menu without having to re-enter the PIN. However, once the appliance enters Screen-Saver Mode, whether from the 6 second time out or from pressing the **Left** button from the Main Menu, the PIN number must be re-entered again to access the Configuration Menu.

After entering a new value for a setting in the configuration menu, you are asked if you want to commit changes. Using the 4-way D-pad, press the **Right** button for yes or the **Left** button for no.

Commit Changes?
<-No Yes->

If you choose yes, the screen notifies you that the settings are updated.

Settings updated

Configuration Options

This option allows you to configure network port settings for the appliance. Once selected, the LCD displays a list of configurable options. Status options available include:

- X0 IP and subnet
- X1 Mode
- X1 IP and subnet
- X1 Gateway
- X1 DNS settings (3 available)
- Restore defaults

The **X1 Mode** can be set to **Static** (default option) or to **DHCP**. If **DHCP** is selected, manual configuration options are not shown for X1 IP, subnet, gateway and DNS.

The **Restore Defaults** option will reset the appliance to default factory settings. If selected it will prompt for confirmation twice before restoring defaults.

If an option is selected but not modified, the appliance will display a message stating that no changes were made and will return the user to the edit value screen. If a change was made, it will prompt the user for confirmation before effecting the change.

Restart

This option allows you to safely restart without resorting to power cycling the appliance. Once selected, the LCD will display a confirmation prompt. Select **Y** for yes and press the **Right** button to confirm. The appliance will reboot.

SafeMode

This option will set the appliance to SafeMode. Once selected, the LCD will display a confirmation prompt. Select **Y** for yes and press the **Right** button to confirm. The appliance will change to SafeMode. Once SafeMode is enabled, the Dell SonicWALL NSA E8510 must be controlled from the Web management interface using the default LAN IP address, 192.168.168.168.

Screen-Saver

If no button is pressed for over 60 seconds, or if the **Left** button is pressed from the Main Menu, the appliance will enter Screen-Saver mode. In this mode, the Status List will cycle, displaying every entry for a few seconds.

If the **Up** or **Down** button is pressed while in Screen-Saver mode, the appliance will display the adjacent status entry.

To exit Screen-Saver mode, press the **Right** button.

LAN IP Configuration Example

The Dell SonicWALL NSA E8510 is assigned the default LAN IP of 192.168.168.168. The following example provides steps for changing the default IP address to 192.168.168.10.

1. Press **Right** to exit screen-saver mode if not at the root menu.
2. Press **Down** to select the Configuration entry.

```
Status >
Configuration >
```

3. Press **Right** to enter Configuration Mode.
4. Input PIN (76642 by default; SONIC on a phone keypad.)

```
Enter PIN:
█
```

5. Press **Up** or **Down** until the cursor displays 7, press **Right**.
6. Continue this process until all of the numbers are entered.

```
Enter PIN:
****█
```

7. Press **Right** to commit changes.

```
Commit Changes?
<-No      Yes->
```

8. Press **Down** until X0 IP is selected (four times).
9. Press **Right** to configure X0 IP.

```
X0 IP:
192.168.168.168
```

10. Edit X0 IP:
11. Press **Right** ten times to select the tenth digit.

```
X0 IP:
192.168.168.█168
```

12. Press **UP** or **Down** until the cursor displays 0.
13. Press **Right** once to select the next digit.
14. Press **UP** or **Down** until the cursor displays 1.
15. Press **Right** once to select the next digit.
16. Press **Up** or **Down** until the cursor displays 0.

```
X0 IP:
192.168.168.01█
```

17. Press **Right** to finish editing the X0 IP.
18. Press **Right** again to confirm changes.

In this Section:

This section provides instructions for registering your Dell SonicWALL NSA E8510.

- [Before You Register](#) - page 19
- [Creating a MySonicWALL Account](#) - page 20
- [Registering and Licensing Your Appliance on MySonicWALL](#) - page 20



Note: *Registration is an important part of the setup process and is necessary in order to receive the benefits of Dell SonicWALL security services, firmware updates, and technical support.*

Before You Register

You need a MySonicWALL account to register the Dell SonicWALL NSA E8510. You can create a new MySonicWALL account on www.mysonicwall.com or directly from the Dell SonicWALL management interface. This section describes how to create an account by using the Web site.

You can use MySonicWALL to register your Dell SonicWALL appliance and activate or purchase licenses for Security Services, Analyzer Reporting and other services, support, or software before you even connect your device. This allows you to prepare for your deployment before making any changes to your existing network.

For a High Availability configuration, you must use MySonicWALL to associate a secondary unit that can share the Security Services licenses with your primary appliance.



Note: *Your Dell SonicWALL NSA E8510 does not need to be powered on during account creation or during the MySonicWALL registration and licensing process.*



Note: *After registering a new Dell SonicWALL appliance on MySonicWALL, you must also register the appliance from the SonicOS management interface. This allows the unit to synchronize with the Dell SonicWALL License Server and to share licenses with the associated appliance, if any. See the [Accessing the Management Interface](#) section, on page 33.*

Creating a MySonicWALL Account

To create a MySonicWALL account, perform the following steps:

1. In your browser, navigate to:
www.mysonicwall.com
2. In the login screen, click the **Register Now** link if you are Not a registered user.



3. Complete the Registration form and then click **Register**.
4. Verify that the information is correct and then click **Submit**.
5. In the screen confirming that your account was created, click **Continue**.

Registering and Licensing Your Appliance on MySonicWALL

This section contains the following subsections:

- [Product Registration](#) - page 20
- [Licensing Application Intelligence and Control](#) - page 21
- [Registering a Secondary Appliance](#) - page 23
- [Registration Next Steps](#) - page 24

Product Registration

You must register your Dell SonicWALL appliance on MySonicWALL to enable full functionality.

1. Login to your MySonicWALL account. If you do not have an account, you can create one at:
www.mysonicwall.com
2. On the main page, in the Register A Product field, type the appliance serial number and then click **Next**.
3. On the My Products page, under Add New Product, type the friendly name for the appliance, select the Product Group if any, type the authentication code into the appropriate text boxes, and then click **Register**.
4. On the Product Survey page, fill in the requested information and then click **Continue**.

Licensing Application Intelligence and Control

In SonicOS 5.8 and higher, Application Intelligence and Application Control are available as licensed services.

- The Intelligence component is licensed as **App Visualization**, and provides identification and reporting of application traffic on the Dashboard > Real-Time Monitor and App Flow Monitor pages.
- The Control component is licensed as **App Control**, and allows you to create and enforce custom App Control and App Rules policies for logging, blocking, and bandwidth management of application traffic handled by your network.

Application Visualization and App Control are licensed together in a bundle with other security services including Dell SonicWALL Gateway Anti-Virus (GAV), Anti-Spyware, and Intrusion Prevention Service (IPS).



Note: *Upon registration on MySonicWALL, or when you load SonicOS 5.8 onto a registered Dell SonicWALL appliance, supported Dell SonicWALL appliances begin an automatic 30-day trial license for App Visualization and App Control, and application signatures are downloaded to the appliance.*

Once the App Visualization feature is manually enabled on the **Log > Flow Reporting** page by selecting the **Enable Flow Reporting and Visualization** checkbox, you can view real-time application traffic on the **Dashboard > Real-Time Monitor** page and application activity in other Dashboard pages for the identified/classified flows from the Dell SonicWALL application signature database.

To begin using App Control, select the **Enable App Control** checkbox on the **Firewall > App Control Advanced** page.

To create policies using App Rules, which is included with the App Control license, select **Enable App Rules** on the **Firewall > App Rules** page.

The Dell SonicWALL Licensing server provides the App Visualization and App Control license keys to the Dell SonicWALL appliance when you begin a 30-day trial (upon registration) or purchase a Security Services license bundle.

For more information regarding Application Intelligence and Control, reference the following documents on: www.sonicwall.com/us/support/:

- SonicOS 5.8 Application Control Feature Module
- SonicOS 5.8 NetFlow Reporting Feature Module

Licensing Security Services and Software

The **Service Management - Associated Products** page in MySonicWALL lists security services, support options, and software such as Analyzer that you can purchase or try with a free trial. For details, click the **Info** button. Your current licenses are indicated in the **Status** column with either a license key or an expiration date. You can purchase additional services now or at a later time.

The following products and services are available for the Dell SonicWALL NSA E8510:

- Service Bundles:
 - Client/Server Anti-Virus Suite
 - Comprehensive Gateway Security Suite
- Gateway Services:
 - Gateway AV / Anti-Spyware/Intrusion Prevention Service
 - Content Filtering: Premium Edition
 - Stateful High Availability
 - Active/Active High Availability
 - Application Visualization
 - Application Control
 - Comprehensive Anti-Spam (CASS)
- Desktop and Server Software:
 - Enforced Client Anti-Virus and Anti-Spyware
 - Global VPN Client
 - Global VPN Client Enterprise
 - VPN Policy Upgrade (for site-to-site VPN)

- SSL-VPN
- Virtual Assist
- Global Management System
- Analyzer
- Support Services:
 - Dynamic Support 24x7
 - Software and Firmware Updates
- Consulting Services:
 - Implementation Service
 - GMS Preventive Maintenance Service

To manage your licenses, perform the following tasks:

1. In the MySonicWALL Service Management - Associated Products page, check the **Applicable Services** table for services that your Dell SonicWALL appliance is already licensed for. Your initial purchase may have included security services or other software bundled with the appliance. These licenses are enabled on MySonicWALL when the Dell SonicWALL appliance is delivered to you.
2. If you purchased a service subscription or upgrade from a sales representative separately, you will have an **Activation Key** for the product. This key is emailed to you after online purchases, or is on the front of the certificate that was included with your purchase. Locate the product on the Services Management page and click **Enter Key** in that row.

3. In the Activate Service page, type or paste your key into the **Activation Key** field and then click **Submit**. Depending on the product, you will see an Expire date or a license key string in the **Status** column when you return to the Service Management page.
4. To license a product of service, do one of the following:
 - To try a Free Trial of a service, click **Try** in the Service Management page. A 30-day free trial is immediately activated. The Status page displays relevant information including the activation status, expiration date, number of licenses, and links to installation instructions or other documentation. The Service Management page is also updated to show the status of the free trial.
 - To purchase a product or service, click **Buy Now**.
5. In the Buy Service page, type the number of licenses you want in the **Quantity** column for either the 1 year, 2 year, or 3 year license row and then click **Add to Cart**.
6. In the **Checkout** page, follow the instructions to complete your purchase.

The MySonicWALL server will generate a license key for the product. The key is added to the license keyset. You can use the license keyset to manually apply all active licenses to your Dell SonicWALL appliance.

Registering a Secondary Appliance

To ensure that your network stays protected if your Dell SonicWALL appliance has an unexpected failure, you can associate a second appliance with the first in a high availability (HA) pair. You can associate the two appliances as part of the registration process on MySonicWALL. The second Dell SonicWALL appliance will automatically share the Security Services licenses of the primary appliance.

To register a second appliance and associate it with the primary, perform the following steps:

1. Login to your MySonicWALL account.
2. On the main page, in the Register A Product field, type the appliance serial number and then click **Next**.
3. On the My Products page, under Add New Product, type the friendly name for the appliance, select the Product Group if any, type the authentication code into the appropriate text boxes, and then click **Register**.
4. On the Product Survey page, fill in the requested information and then click **Continue**. The Create Association Page is displayed.

5. On the Create Association Page, click the radio button to select the primary unit for this association, and then click **Continue**. The screen only displays units that are not already associated with other appliances.
6. On the Service Management - Associated Products page, scroll down to the Associated Products section to verify that your product registered successfully. You should see the HA Primary unit listed in the Parent Product section, as well as a Status value of **0** in the Associated Products / Child Product Type section.

To return to the Service Management - Associated Products page, click the serial number link for this appliance.

Registration Next Steps

Your Dell SonicWALL NSA E8510 or E8510 HA Pair is now registered and licensed on MySonicWALL. To complete the registration process in SonicOS and for more information, see:

- [Accessing the Management Interface](#) - page 33
- [Activating Licenses in SonicOS](#) - page 35
- [Enabling Security Services in SonicOS](#) - page 51
- [Applying Security Services to Zones](#) - page 52

In this Section:

This section provides detailed overviews of advanced deployment scenarios as well as configuration instructions for connecting your Dell SonicWALL NSA E8510.

- [Selecting a Deployment Scenario](#) - page 27
 - [Scenario A: NAT/Route Mode Gateway](#) - page 28
 - [Scenario B: State Sync Pair in NAT/Route Mode](#) - page 29
 - [Scenario C: L2 Bridge Mode](#) - page 30
- [Initial Setup](#) - page 31
- [Configuring a Stateful HA Pair](#) - page 38
- [Configuring L2 Bridge Mode](#) - page 44



Note: Before completing this section, fill out the information in the [Obtain Configuration Information](#) section, on page 8. You will need to enter this information during the **Setup Wizard**.

Selecting a Deployment Scenario

Before continuing, select a deployment scenario that best fits your network scheme. Reference the table below and the diagrams on the following pages for help in choosing a scenario.

Current Gateway Configuration	New Gateway Configuration	Use Scenario
No gateway appliance	A single NSA E8510 as a primary gateway.	A - NAT/Route Mode Gateway
	A pair of Dell SonicWALL NSA E-Class appliances for high availability.	B - NAT with State Sync Pair
Existing Internet gateway appliance	An NSA E8510 as replacement for an existing gateway appliance.	A - NAT/Route Mode Gateway
	An NSA E8510 in addition to an existing gateway appliance.	C - L2 Bridge Mode
Existing Dell SonicWALL gateway appliance	An NSA E8510 in addition to an existing Dell SonicWALL gateway appliance.	B - NAT with State Sync Pair

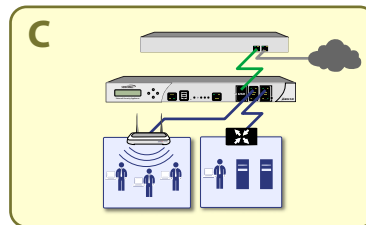
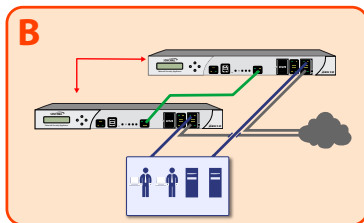
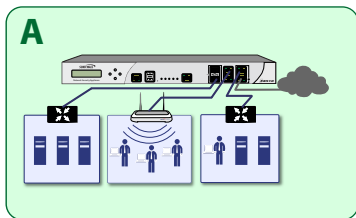

- [Scenario A: NAT/Route Mode Gateway](#) - page 28
- [Scenario B: State Sync Pair in NAT/Route Mode](#) - page 29
- [Scenario C: L2 Bridge Mode](#) - page 30

Scenario A: NAT/Route Mode Gateway

For new network installations or installations where the Dell SonicWALL NSA E8510 is replacing the existing network gateway.

In this scenario, the Dell SonicWALL NSA E8510 is configured in NAT/Route mode to operate as a single network gateway. Two Internet sources may be routed through the Dell SonicWALL appliance for load balancing and failover purposes. Because only a single Dell SonicWALL appliance is deployed, the added benefits of high availability with a stateful synchronized pair are not available.

To set up this scenario, follow the steps covered in:

- [Initial Setup](#) - page 31
- [Additional Deployment Configuration](#) - page 46



Note: *Be sure to follow the steps in the [Initial Setup](#) section, on page 31 before completing Additional Deployment Configurations.*

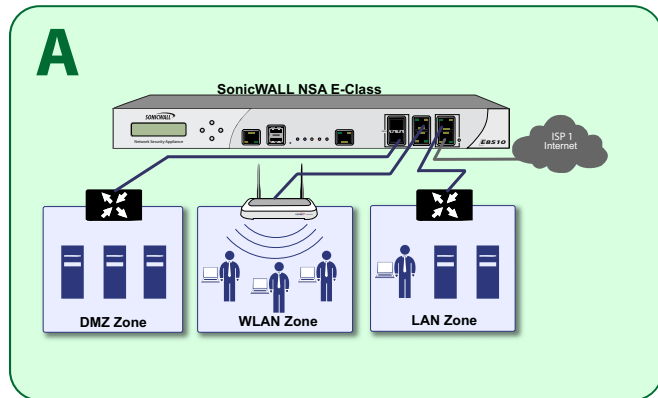

Scenario B: State Sync Pair in NAT/Route Mode

For network installations with two Dell SonicWALL NSA E-Class appliances configured as a stateful synchronized pair for redundant high-availability networking.

In this scenario, one Dell SonicWALL NSA E8510 operates as the primary gateway device and the other Dell SonicWALL NSA E8510 is in passive mode. All network connection information is synchronized between the two devices so that the backup appliance can seamlessly switch to active mode without dropping connections if the primary device loses connectivity.



Note: Active/Active Deep Packet Inspection (A/A DPI) functionality is also available for high-availability deployments. For more information on the benefits and setup instruction for Active/Active DPI, see the “SonicOS Active/Active Feature Module” at: www.sonicwall.com/us/support

To set up this scenario, follow the steps covered in:

- [Initial Setup](#) - page 31
- [Configuring L2 Bridge Mode](#) - page 44
- [Additional Deployment Configuration](#) - page 46



Note: Follow the steps in the [Initial Setup](#) section, on page 31 before completing State Sync Pair setup.

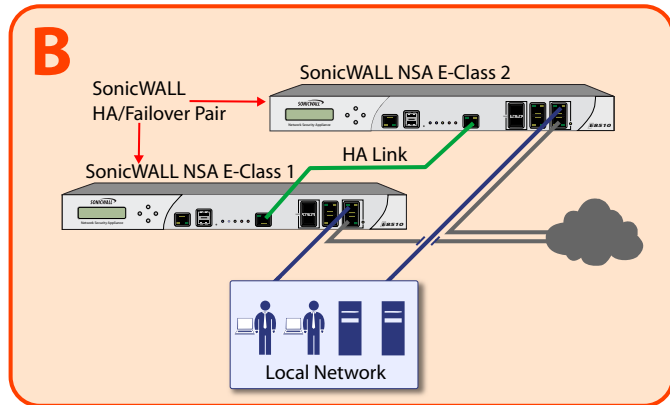

Scenario C: L2 Bridge Mode

For network installations where the Dell SonicWALL NSA E8510 is running in tandem with an existing network gateway.

In this scenario, the original gateway is maintained. The Dell SonicWALL NSA E8510 is integrated seamlessly into the existing network, providing the benefits of deep packet inspection and comprehensive security services on all network traffic.

L2 Bridge Mode employs a secure learning bridge architecture, enabling it to pass and inspect traffic types that cannot be handled by many other methods of transparent security appliance integration. Using L2 Bridge Mode, a Dell SonicWALL appliance can be non-disruptively added to any Ethernet network to provide in-line deep-packet inspection for TCP and UDP traffic.

To set up this scenario, follow the steps covered in:

- [Initial Setup](#) - page 31
- [Configuring L2 Bridge Mode](#) - page 44
- [Additional Deployment Configuration](#) - page 46



Note: Be sure to follow the steps in the [Initial Setup](#) section, on page 31 before completing L2 Bridge Mode setup.

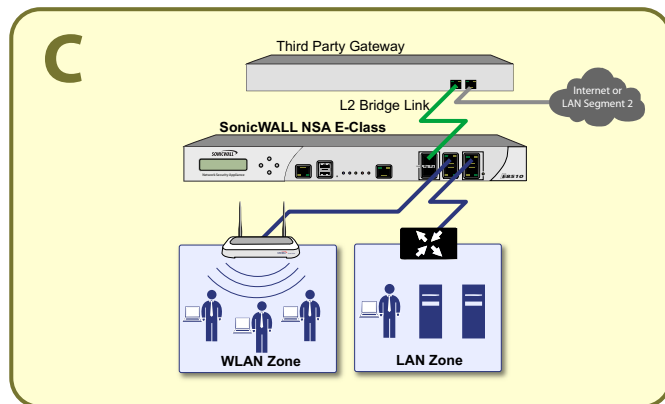

Initial Setup

This section provides initial configuration instructions for connecting your Dell SonicWALL NSA E8510. Follow these steps if you are setting up **Scenario A, B, or C**.





This section contains the following sub-sections:

- [System Requirements](#) - page 31
- [Connecting the WAN Port](#) - page 31
- [Connecting the LAN Port](#) - page 32
- [Applying Power](#) - page 32
- [Accessing the Management Interface](#) - page 33
- [Using the Setup Wizard](#) - page 33
- [Connecting to Your Network](#) - page 34
- [Testing Your Connection](#) - page 34
- [Activating Licenses in SonicOS](#) - page 35
- [Upgrading Firmware](#) - page 35

System Requirements

Before you begin the setup process, check to verify that you have:

- An Internet connection
- A Web browser supporting Java Script and HTTP uploads

	Accepted Browser	Browser Version Number
	Chrome	18.0 or higher
	Firefox	16.0 or higher
	Internet Explorer	8.0, 9.0, and 10.0 (do not use Compatibility mode)
	Safari	5.0 or higher for MacOS

Connecting the WAN Port

1. Connect one end of an Ethernet cable to your Internet connection.
2. Connect the other end of the cable to the **X1 (WAN)** port on your Dell SonicWALL NSA E8510.

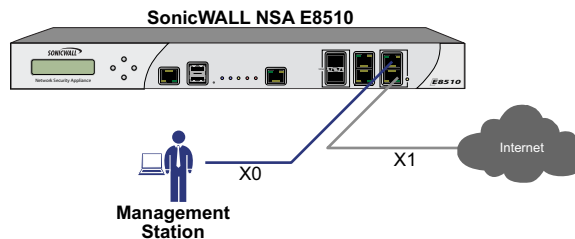

Connecting the LAN Port

1. Connect one end of the provided Ethernet cable to the computer you are using to manage the Dell SonicWALL NSA E8510.
2. Connect the other end of the cable to the **X0** port on your Dell SonicWALL NSA E8510.

The Link LED above the **X0 (LAN)** port will light up in green or amber depending on the link throughput speed, indicating an active connection:

- Amber indicates 1 Gbps
- Green indicates 100 Mbps
- Unlit while the right (activity) LED is illuminated indicates 10 Mbps

Applying Power

1. Connect the power cords from the Dell SonicWALL NSA E8510 into appropriate power outlets. For further information on power requirements, see the *Safety and Regulatory Information*, on page 69 of this document.
2. Turn on both power switches on the rear of the appliance next to the power cords.

The Power LEDs on the front panel light up blue when you plug in the Dell SonicWALL NSA E8510. The Alarm LED may light up and the Test LED will light up and may blink while the appliance performs a series of diagnostic tests.

When the Power LEDs are lit and the Test LED is no longer lit, the Dell SonicWALL NSA E8510 is ready for configuration. This typically occurs within a few minutes of applying power to the appliance.



Warning: *When disconnecting power, be sure to remove both power cords from the unit.*



Note: *Only one power supply is required for the appliance to operate.*



Note: *If the Test or Alarm LEDs remain lit after the Dell SonicWALL NSA E8510 has booted, restart the appliance by cycling power.*

Accessing the Management Interface

The computer you use to manage the Dell SonicWALL NSA E8510 must be set up to accept a dynamic IP address, or it must have an unused IP address on the 192.168.168.x/24 subnet, such as 192.168.168.20.

To access the SonicOS Web-based management interface:

1. Start your Web browser.
2. Disable pop-up blocking software or add the management IP address `http://192.168.168.168` to your pop-up blocker's allow list.
3. Enter **http://192.168.168.168** (the default LAN management IP address) in the **Location** or **Address** field.
4. The **Dell SonicWALL Setup Wizard** launches and guides you through the configuration and setup of your Dell SonicWALL NSA E8510.



Note: *The **Setup Wizard** launches automatically only upon initial loading of the Dell SonicWALL NSA E8510 management interface.*

5. Follow the on-screen prompts to complete the Setup Wizard.

Depending on the changes made during your setup configuration, the Dell SonicWALL appliance may restart.

Using the Setup Wizard

If you cannot connect to the Dell SonicWALL NSA E8510 or the **Setup Wizard** does not display, verify the following configurations:

- Did you correctly enter the Dell SonicWALL NSA E8510 management IP address in your Web browser?
- Are the Local Area Connection settings on your computer set to use DHCP or set to a static IP address on the 192.168.168.x/24 subnet?
- Do you have the Ethernet cable connected to your computer and to the **X0 (LAN)** port on your Dell SonicWALL appliance?
- Is the connector clip on your network cable properly seated in the port of the security appliance?
- Some browsers may not launch the **Setup Wizard** automatically. In this case:
 - Log into Dell SonicWALL NSA E8510 using "**admin**" as the user name and "**password**" as the password.
 - Click the **Wizards** button located at the top right corner of the screen.
 - Select **Setup Wizard** and click **Next** to launch the Setup Wizard.
 - Some pop-up blockers may prevent the launch of the Setup Wizard. You can temporarily disable your pop-up blocker, or add the management IP address of your Dell SonicWALL appliance (192.168.168.168 by default) to your pop-up blocker's allow list.

Connecting to Your Network

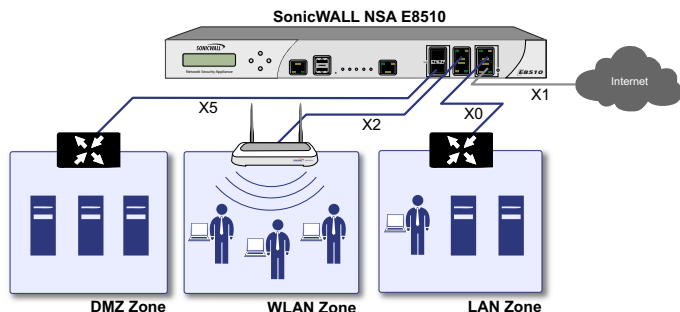

The Dell SonicWALL NSA E8510 ships with the internal DHCP server active on the LAN port. However, if a DHCP server is already active on your LAN, the Dell SonicWALL appliance will disable its own DHCP server to prevent conflicts.

As shown in the illustration on this page, ports X1 and X0 are preconfigured as WAN and LAN respectively. The remaining ports (X2-X5) can be configured to meet the needs of your network. In the graphical example on this page, the zones are: X1: WAN, X0: LAN, X2: WLAN, X5: DMZ.

The above example is only for reference, your own port to zone assignments depend on your networking goals and needs. Refer to the *SonicOS Administrator's Guide* for more advanced configuration deployments.

Testing Your Connection

1. After you exit the Setup Wizard, the login page reappears. Log back into the Management Interface and verify your IP and WAN connection.
2. Ping a site outside of your local network, such as: <http://www.sonicwall.com>
3. Open another Web browser and navigate to: <http://www.sonicwall.com>
If you can view the Dell SonicWALL home page, you have configured your Dell SonicWALL NSA E8510 correctly. If you cannot view the Dell SonicWALL home page, renew your management station DHCP address.
4. If you still cannot view a Web page, try one of these solutions:
 - **Restart your Management Station** to accept new network settings from the DHCP server in the Dell SonicWALL appliance.
 - **Restart your Internet Router** to communicate with the DHCP Client in the Dell SonicWALL appliance.

Activating Licenses in SonicOS

After completing the registration process in SonicOS, you must perform the following tasks to activate your licenses and enable your licensed services from within the SonicOS user interface:

- Activate licenses
- Enable security services
- Apply services to network zones

This section describes how to activate your licenses. For instructions on how to enable security services and apply services to network zones, see the following sections:

- [Enabling Security Services in SonicOS](#) - page 51
- [Applying Security Services to Zones](#) - page 52

To activate licensed services in SonicOS, you can enter the license keyset manually, or you can synchronize all licenses at once with MySonicWALL.

The Setup Wizard automatically synchronizes all licenses with MySonicWALL if the appliance has Internet access during initial setup. If initial setup is already complete, you can synchronize licenses from the **System > Licenses** page.

Manual upgrade using the license keyset is useful when your appliance is not connected to the Internet. The license keyset includes all license keys for services or software enabled on MySonicWALL. It is available on MySonicWALL at the top of the Service Management page for your SonicWALL appliance.

To activate licenses in SonicOS:

1. Navigate to the **System > Licenses** page.
2. Under Manage Security Services Online do one of the following:
 - Enter your MySonicWALL credentials, then click the **Synchronize** button to synchronize licenses with MySonicWALL.
 - Paste the license keyset into the **Manual Upgrade Keyset** field.
3. Click **Submit**.

Upgrading Firmware

The following procedures are for upgrading an existing SonicOS image to a newer version:

- [Obtaining the Latest Firmware](#) - page 35
- [Saving a Backup Copy of Your Preferences](#) - page 36
- [Upgrading the Firmware](#) - page 36
- [Using SafeMode to Upgrade Firmware](#) - page 37

Obtaining the Latest Firmware

1. To obtain a new SonicOS firmware image file for your Dell SonicWALL appliance, connect to your MySonicWALL account at www.mysonicwall.com
2. Copy the new SonicOS image file to a convenient location on your management station.

Saving a Backup Copy of Your Preferences

Before beginning the update process, make a system backup of your Dell SonicWALL appliance configuration settings. The backup feature saves a copy of the current configuration settings on your Dell SonicWALL appliance, protecting all your existing settings in the event that it becomes necessary to return to a previous configuration state.

In addition to using the backup feature to save your current configuration state to the Dell SonicWALL appliance, you can export the configuration preferences file to a directory on your local management station. This file serves as an external backup of the configuration preferences, and can be imported back into the Dell SonicWALL appliance.

Perform the following procedures to save a backup of your configuration settings and export them to a file on your local management station:

1. On the **System > Settings** page, click **Create Backup**. Your configuration preferences are saved. The System Backup entry is displayed in the **Firmware Management** table.
2. To export your settings to a local file, click **Export Settings**. A popup window displays the name of the saved file.

Upgrading the Firmware

Perform the following steps to upload new firmware to your Dell SonicWALL appliance and use your current configuration settings upon startup.



Note: *The appliance must be properly registered before it can be upgraded. Refer to the [Registering and Licensing Your Appliance on MySonicWALL](#) section, on page 20 for more information.*

1. Download the SonicOS firmware image file from MySonicWALL and save it to a location on your local computer.
2. On the **System > Settings** page, click **Upload New Firmware**.
3. Browse to the location where you saved the SonicOS firmware image file, select the file and click the **Upload** button.
4. On the **System > Settings** page, click the **Boot** icon in the row for **Uploaded Firmware - New!** or **Uploaded Firmware with Factory Default Settings - New!**
5. In the confirmation dialog box, click **OK**. The Dell SonicWALL appliance restarts and then displays the login page.
6. Enter your user name and password. Your new SonicOS image version information is listed on the **System > Settings** page.

Using SafeMode to Upgrade Firmware

If you are unable to connect to the Dell SonicWALL appliance's management interface, you can restart the appliance in SafeMode. The SafeMode feature allows you to recover quickly from uncertain configuration states with a simplified management interface that includes the same settings available on the **System > Settings** page.

To use SafeMode to upgrade firmware on the Dell SonicWALL appliance, perform the following steps:

1. Connect your computer to the X0 port on the Dell SonicWALL appliance and configure your IP address with an address on the 192.168.168.0/24 subnet, such as 192.168.168.20.
2. To configure the appliance in SafeMode, perform one of the following methods:
 - Use a narrow, straight object, like a straightened paper clip or a toothpick, to press and hold the **reset** button on the front of the security appliance for at least twenty seconds. See *The Front Panel*, on page 10 to locate the reset button.
 - Use the LCD control buttons on the front bezel to set the appliance to SafeMode. Once selected, the LCD displays a confirmation prompt. Select **Y** and press the **Right** button to confirm. The Dell SonicWALL appliance changes to SafeMode.

The Test light starts blinking when the Dell SonicWALL appliance has rebooted into SafeMode.

3. Point the Web browser on your computer to **192.168.168.168**. The SafeMode management interface displays.
4. Click **Upload New Firmware**, and then browse to the location where you saved the SonicOS firmware image, select the file and click the **Upload** button.
5. Select the boot icon in the row for one of the following:
 - **Uploaded Firmware - New!**
Use this option to restart the appliance with your current configuration settings.
 - **Uploaded Firmware with Factory Default Settings - New!**
Use this option to restart the appliance with default configuration settings.
6. In the confirmation dialog box, click **OK** to proceed.
7. After successfully booting the firmware, the login screen is displayed. If you booted with factory default settings, enter the default user name and password (admin / password) to access the Dell SonicWALL management interface. Use the table below to complete setup for your scenario. Look for this "Next" icon to guide you to the next section.

If You Are Following Scenario...	Proceed to Section:
A - NAT/Route Mode Gateway	Additional Deployment Configuration - page 46
B - NAT with State Sync Pair	Configuring L2 Bridge Mode - page 44
C - L2 Bridge Mode	Configuring L2 Bridge Mode - page 44

Configuring a Stateful HA Pair

This section provides instructions for configuring a pair of Dell SonicWALL NSA E8510 appliances for high availability (HA). This section is relevant to administrators following deployment **Scenario B**.

This section contains the following sub-sections:

- [Initial High Availability Setup](#) - page 38
- [Configuring High Availability](#) - page 39
- [Configuring Advanced HA Settings](#) - page 39
- [Configuring HA Monitoring Settings](#) - page 41
- [Synchronize Settings](#) - page 41
- [HA License Configuration Overview](#) - page 42
- [Associating Pre-Registered Appliances](#) - page 43

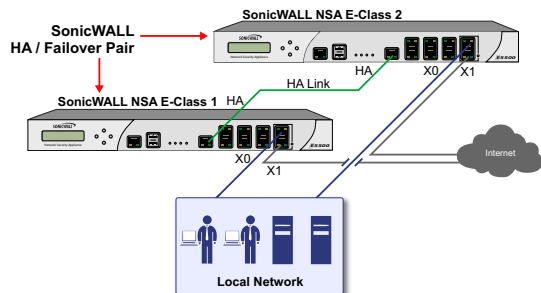

Initial High Availability Setup

Before you begin the configuration of HA on the Primary Dell SonicWALL security appliance, perform the following setup:

- On the bottom panel of the secondary Dell SonicWALL security appliance, locate the serial number and write the number down. You need to enter this number in the **High Availability > Settings** page.
- Verify that the primary and secondary Dell SonicWALL security appliances are registered, running the same SonicOS versions.
- Make sure the primary and secondary Dell SonicWALL security appliances' LAN, WAN and other interfaces are properly configured for failover.
- Connect the HA ports on the primary and secondary Dell SonicWALL appliances with a CAT6-rated crossover cable (red crossover cable). The primary and secondary Dell SonicWALL security appliances must have a dedicated connection using the HA interface. Dell SonicWALL recommends cross-connecting the two together using a CAT 6 crossover Ethernet cable, but a connection using a dedicated 100Mbps hub/switch is also valid.

- Power up the primary Dell SonicWALL security appliance, and then power up the secondary Dell SonicWALL security appliance.
- Do not make any configuration changes to the primary's HA interface; the High Availability configuration in an upcoming step takes care of this issue. When done, disconnect the workstation.

Configuring High Availability

The first task in setting up HA after initial setup is configuring the **High Availability > Settings** page on the primary Dell SonicWALL security appliance. Once you configure HA on the primary Dell SonicWALL security appliance, it communicates the settings to the secondary Dell SonicWALL security appliance.

To configure HA on the primary appliance, perform the following steps:

1. Navigate to the **High Availability > Settings** page.
2. Select the **Enable High Availability** checkbox.
3. Under **SonicWALL Address Settings**, type in the serial number for the secondary Dell SonicWALL appliance.

You can find the serial number on the bottom of the Dell SonicWALL security appliance, or in the **System > Status** screen of the secondary unit. The serial number for the primary Dell SonicWALL is automatically populated.

4. Click **Apply** to retain these settings.

Configuring Advanced HA Settings

1. Navigate to the **High Availability > Advanced** page.
2. To configure Stateful HA, select **Enable Stateful Synchronization**. A dialog box is displayed with recommended settings for the **Heartbeat Interval** and **Probe Interval** fields. The settings it shows are minimum recommended values. Lower values may cause unnecessary failovers, especially when the appliance is under a heavy load. You can use higher values if your SonicWALL handles a lot of network traffic. Click **OK**.
3. To cause the HA pair to change back to the original primary unit when it becomes available after a failover, select the **Enable Preempt Mode** checkbox.
4. To backup the firmware and settings when you upgrade the firmware version, select **Generate/Overwrite Backup Firmware and Settings When Upgrading Firmware**.
5. Select the **Enable Virtual MAC** checkbox. Virtual MAC allows the primary and secondary appliances to share a single MAC address. This greatly simplifies the process of updating network ARP tables and caches when a failover occurs. Only the WAN switch that the two appliances are connected to needs to be notified. All outside devices will continue to route to the single shared MAC address.
6. Optionally adjust the **Heartbeat Interval** to control how often the two units communicate. This timer is the length of time between status checks. By default this timer is set to 5000 milliseconds, the minimum recommended value is 1000 milliseconds. Using a longer interval will result in the appliance taking more time to detect when/if failures have occurred. Less than this may cause unnecessary failovers, especially when the appliance is under a heavy load.

7. Set the **Probe Interval** for the interval in seconds between communication with upstream or downstream systems. This timer controls the path monitoring speed. Path monitoring sends pings to specified IP addresses to monitor that the network critical path is still reachable. The default is 20 seconds, and the allowed range is from 5 to 255 seconds. It is recommended that you set the interval for at least 5 seconds. You can set the Probe IP Address(es) on the **High Availability > Monitoring** screen.
8. In the **Probe Count** text-field, enter the desired number of consecutive probes before the appliance considers the network critical path to be reachable or broken. The minimum and default is 3 probes, and the maximum is 10.
9. Typically, Dell SonicWALL recommends leaving the **Failover Trigger Level (missed heart beats)**, **Election Delay Time (seconds)**, and **Dynamic Route Hold-Down Time** fields to their default settings. These fields can be tuned later as necessary for your specific network environment.
 - The **Failover Trigger Level (missed heart beats)** timer is the number of heartbeats the appliance will miss before failing over. By default, this time is set to 5 missed heart beats. This timer is linked to the Heartbeat Interval timer – for example, if you set the Heartbeat Interval to 10 seconds, and the Failover Trigger Level timer to 5, it will be 50 seconds before the appliance fails over.
 - The **Election Delay Time** can be used to specify an amount of time the appliance will wait to consider an interface up and stable before one of them takes the primary role. This is useful when dealing with switch ports that have a spanning-tree delay set
 - The **Dynamic Route Hold-Down Time** setting is used when a failover occurs on a HA pair that is using either RIP or OSPF dynamic routing. When a failover occurs, **Dynamic Route Hold-Down Time** is the number of seconds the newly-active appliance keeps the dynamic routes it had previously learned in its route table. During this time, the newly-active appliance relearns the dynamic routes in the network. When the **Dynamic Route Hold-Down Time** duration expires, it deletes the old routes and implements the new routes it has learned from RIP or OSPF. The default value is 45 seconds. In large or complex networks, a larger value may improve network stability during a failover.
10. Click the **Include Certificates/Keys** checkbox to have the appliances synchronize all certificates and keys.
11. Click **Synchronize Settings** to synchronize the settings between the primary and secondary appliances.
12. Click **Synchronize Firmware** if you previously uploaded new firmware to your Primary unit while the Secondary unit was offline, and it is now online and ready to upgrade to the new firmware. **Synchronize Firmware** is typically used after taking your Secondary appliance offline while you test a new firmware version on the Primary unit before upgrading both units to it.
13. Click **Accept** to retain the settings on this screen.

Configuring HA Monitoring Settings

After configuring the HA settings, you need to configure the Monitoring settings for the LAN or WAN. This includes configuring unique IP addresses for each appliance in the Stateful HA pair. You will need to log into the appliances using these IP addresses in order to complete the registration process from within SonicOS, which will allow license sharing and synchronization.

Navigate to the **High Availability > Monitoring** page to configure the Monitoring settings.

1. Click the **Configure** icon of the Interface for which you want to edit settings. The **Edit HA Monitoring** dialog box displays.

Interface 'X2' Monitoring Settings

Enable Physical/Link Monitoring

Primary IP Address:

Backup IP Address:

Allow Management on Primary/Backup IP Address

Logical/Probe IP Address:

Override Virtual MAC:

2. In the **Primary IP Address** field, enter the unique LAN or WAN management IP address of the Primary appliance.
3. In the **Secondary IP Address** field, enter the unique LAN or WAN management IP address of the Secondary appliance.
4. Select the **Allow Management on Primary/Secondary IP Address** checkbox.
5. *Optionally* **Enable Physical / Link Monitoring** by selecting the checkbox.
6. *Optionally* enable **Logical / Probe IP Address** by selecting the checkbox and providing the IP Address of the target host.
7. Click **OK**.

You can repeat these steps to configure Monitoring on other interfaces.

For more information regarding the optional settings, see the *SonicOS Administrator's Guide*.

Synchronize Settings

Once you have configured the HA setting on the Primary Dell SonicWALL security appliance, click the **Synchronize Settings** button. You should see a **HA Peer Firewall has been updated** message at the bottom of the management interface page. Also note that the management interface displays **Logged Into: Primary SonicWALL Status: Active** in the upper-right-hand corner.

By default, the **Include Certificate/Keys** setting is enabled. This specifies that Certificates, CRLs and associated settings (such as CRL auto-import URLs and OCSP settings) are synchronized between the primary and secondary units. When Local Certificates are copied to the secondary unit, the associated Private Keys are also copied. Because the connection between the primary and secondary units is typically protected, this is generally not a security concern.



Note: *A compromise between the convenience of synchronizing Certificates and the added security of not synchronizing Certificates is to temporarily enable the **Include Certificate/Keys** setting and manually synchronize the settings, and then disable **Include Certificate/Keys**.*

To verify that primary and secondary Dell SonicWALL security appliances are functioning correctly, wait a few minutes, then power off the Primary Dell SonicWALL device. The secondary Dell SonicWALL security appliance should quickly take over.

From your management workstation, test connectivity through the secondary Dell SonicWALL by accessing a site on the public Internet – note that the secondary Dell SonicWALL, when active, assumes the complete identity of the primary, including its IP addresses and Ethernet MAC addresses.

Log into the secondary Dell SonicWALL's unique LAN IP address. The management interface should now display **Logged Into: Backup SonicWALL Status: Active** in the upper-right-hand corner.





Now, power the primary appliance back on, wait a few minutes, then log back into the management interface. If stateful synchronization is enabled (automatically disabling preempt mode), the management GUI should still display **Logged Into: Backup SonicWALL Status: Active** in the upper-right-hand corner.

If you are using the Monitor Interfaces feature, experiment with disconnecting each monitored link to ensure correct configuration.

HA License Configuration Overview

You can configure HA license synchronization by associating two Dell SonicWALL security appliances as HA Primary and HF secondary on MySonicWALL. Note that the secondary appliance of your HA pair is referred to as the HF Secondary unit on MySonicWALL. Also note that the secondary appliance must be an identical model to the primary applicancy (such as two NSA E5500 appliances).

You must purchase a single set of security services licenses for the HA Primary appliance. To use Stateful HA, you must first activate the Stateful High Availability Upgrade license for the primary unit in SonicOS. This is automatic if the appliance is connected to the Internet. See the [Registering and Licensing Your Appliance on MySonicWALL](#) section, on page 20.

Service Name	Download	Status	Count	Expiration	Action
▼ GATEWAY SERVICES					
Gateway AV/Anti-Spyware/Intrusion Prevention/App Control/App Visualization		Licensed		May 30 2013	 
Content Filtering: Premium Edition		Licensed		May 30 2013	 
VPN Upgrade		Licensed			
SonicOS Enhanced		Licensed			
Stateful High Availability		Licensed			

License synchronization is used during HA so that the secondary appliance can maintain the same level of network protection provided before the failover. To enable HA, you can use the SonicOS UI to configure your two appliances as a HA pair in Active/Idle mode.

MySonicWALL provides several methods of associating the two appliances. You can start by registering a new appliance, and then choosing an already-registered unit to associate it with. You can associate two units that are both already registered. Or, you can select a registered unit and then add a new appliance with which to associate it.



Note: After registering new Dell SonicWALL appliances on MySonicWALL, you must also register each appliance from the SonicOS management interface by logging into the unique IP address assigned on the **High Availability > Monitoring** page and then clicking the registration link on the **System > Status** page. This allows each unit to synchronize with the license server and share licenses with the associated appliance.

Associating Pre-Registered Appliances

To associate two already-registered Dell SonicWALL security appliances so that they can use HA license synchronization, perform the following steps:

1. Login to MySonicWALL.
2. In the left navigation bar, click **My Products**.
3. On the My Products page, under Registered Products, scroll down to find the appliance that you want to use as the parent, or primary, unit. Click the product **name** or **serial number**.
4. On the Service Management - Associated Products page, scroll down to the Associated Products section.
5. Under Associated Products, click **HF Secondary**.
6. On the My Product - Associated Products page, in the text boxes under Associate New Products, type the **serial number** and the friendly **name** of the appliance that you want to associate as the child/secondary unit.

7. Select the group from the **Product Group** drop-down list. The product group setting specifies the mysonicwall users who can upgrade or modify the appliance.
8. Click **Register**.

If You Are Following Scenario...	Proceed to Section:
B - NAT with State Sync Pair	Additional Deployment Configuration - page 45

Configuring L2 Bridge Mode

This section provides instructions to configure the Dell SonicWALL NSA E8510 appliance in tandem with an existing Internet gateway device. This section is relevant to users following deployment **scenario C**.

This section contains the following sub-sections:

- [Connection Overview](#) - page 44
- [Configuring the Primary Bridge Interface](#) - page 45
- [Configuring the Secondary Bridge Interface](#) - page 45

Connection Overview

Connect the X1 port on your Dell SonicWALL NSA E8510 to the LAN port on your existing Internet gateway device. Then connect the X0 port on your NSA E8510 to your LAN resources.

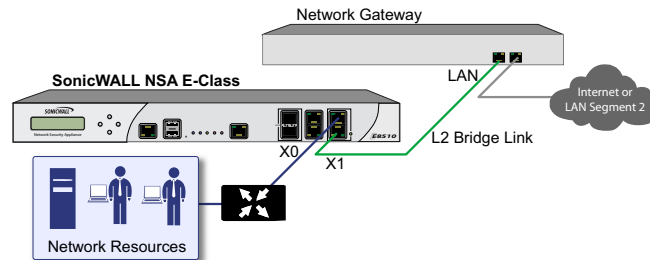

Configuring the Primary Bridge Interface

The primary bridge interface is your existing Internet gateway device. The only step involved in setting up your primary bridge interface is to ensure that the WAN interface is configured for a static IP address. You will need this static IP address when configuring the secondary bridge.



Note: *The primary bridge interface must have a static IP assignment.*

Configuring the Secondary Bridge Interface

Complete the following steps to configure the Dell SonicWALL NSA E8510:

1. Navigate to the **Network > Interfaces** page from the navigation panel.
2. Click the Configure icon in the right column of the X0 (LAN) interface.

Interface 'X0' Settings

Zone: LAN

IP Assignment: Layer 2 Bridged Mode

Bridged to: X1

Block all non-IPv4 traffic

Never route traffic on this bridge-pair

Only sniff traffic on this bridge-pair

Disable stateful-inspection on this bridge-pair

Comment: Default LAN

Management: HTTP HTTPS Ping SNMP SSH

User Login: HTTP HTTPS

Add rule to enable redirect from HTTP to HTTPS

3. In the **IP Assignment** drop-down, select **Layer 2 Bridged Mode**.
4. In the **Bridged to** drop-down, select the **X1** interface.
5. Configure management options (HTTP, HTTPS, Ping, SNMP, SSH, User logins, or HTTP redirects).



Note: *Do not enable **Never route traffic on the bridge-pair** unless your network topology requires that all packets entering the L2 Bridge remain on the L2 Bridge segments. You may optionally enable the **Block all non-IPv4 traffic** setting to prevent the L2 bridge from passing non-IPv4 traffic.*

Continue to the [Additional Deployment Configuration](#) section, on page 46

In this Section:

This section provides basic configuration information to begin building network security policies for your deployment. This section also contains several SonicOS diagnostic tools and a deployment configuration reference checklist.

- [An Introduction to Zones and Interfaces](#) - page 47
- [Creating a NAT Policy](#) - page 48
- [Enabling Security Services in SonicOS](#) - page 51
- [Applying Security Services to Zones](#) - page 52
- [Troubleshooting Diagnostic Tools](#) - page 52

An Introduction to Zones and Interfaces

Zones split a network infrastructure into logical areas, each with its own set of usage rules, security services, and policies. Most networks include multiple definitions for zones, including those for trusted, untrusted, public, encrypted, and wireless traffic.

Some basic (default) zone types include:

WAN—Untrusted resources outside your local network

LAN—Trusted local network resources

WLAN—Local wireless network resources originating from Dell SonicWALL wireless enabled appliances such as SonicPoints.

DMZ—Local network assets that must be accessible from the WAN zone (such as Web and FTP servers)

VPN—Trusted endpoints in an otherwise untrusted zone, such as the WAN

The security features and settings configured for the zones are enforced by binding a zone to one or more physical interfaces (such as, X0, X1, or X2) on the Dell SonicWALL appliance.

The X1 and X0 interfaces are preconfigured as WAN and LAN respectively. The remaining ports can be configured to meet the needs of your network, either by using basic zone types (WAN, LAN, WLAN, DMZ, VPN) or configuring a custom zone type to fit your network requirements (for example: Gaming Console Zone, Wireless Printer Zone, Wireless Ticket Scanner Zone).

A Zone is a logical grouping of one or more interfaces designed to make management, such as the definition and application of access rules, a simpler and more intuitive process than following a strict physical interface scheme.

By default, the Dell SonicWALL appliance's stateful packet inspection allows all communication from the LAN to the Internet, and blocks all traffic from the Internet to the LAN. The following behaviors are defined by the "Default" stateful inspection packet access rule enabled in the Dell SonicWALL appliance:

Originating Zone	Destination Zone	Action
LAN, WLAN	WAN, DMZ	Allow
DMZ	WAN	Allow
WAN	DMZ	Deny
WAN and DMZ	LAN or WLAN	Deny

Creating a NAT Policy

The Network Address Translation (NAT) engine in SonicOS allows users to define granular NAT policies for their incoming and outgoing traffic. By default, the Dell SonicWALL appliance has a preconfigured NAT policy to allow all systems connected to the **LAN** interface to perform Many-to-One NAT using the IP address of the **WAN** interface, and a policy to not perform NAT when traffic crosses between the other interfaces.

You can create multiple NAT policies on a Dell SonicWALL appliance running SonicOS for the same object – for instance, you can specify that an internal server use one IP address when accessing Telnet servers, and to use a totally different IP address for all other protocols. Because the NAT engine in SonicOS supports inbound port forwarding, it is possible to hide multiple internal servers off the WAN IP address of the Dell SonicWALL appliance. The more granular the NAT Policy, the more precedence it takes.

Before configuring NAT Policies, you must create all Address Objects associated with the policy. For instance, if you are creating a One-to-One NAT policy, first create Address Objects for your public and private IP addresses.

Address Objects are one of four object classes (Address, User, Service and Schedule) in SonicOS. These Address Objects allow for entities to be defined one time, and to be re-used in multiple referential instances throughout the SonicOS interface.

For example, take an internal Web server with an IP address of 67.115.118.80. Rather than repeatedly typing in the IP address when constructing Access Rules or NAT Policies, Address Objects allow you to create a single entity called “My Web Server” as a Host Address Object with an IP address of 67.115.118.80. This Address Object, “My Web Server”, can then be easily and efficiently selected from a drop-down menu in any configuration screen that employs Address Objects as a defining criterion.

Since there are multiple types of network address expressions, there are currently the following Address Objects types:

- **Host**—Host Address Objects define a single host by its IP address.
- **Range**—Range Address Objects define a range of contiguous IP addresses.
- **Network**—Network Address Objects are like Range objects in that they comprise multiple hosts, but rather than being bound by specified upper and lower range delimiters, the boundaries are defined by a valid netmask.
- **MAC Address**—MAC Address Objects allow for the identification of a host by its hardware address or MAC (Media Access Control) address.
- **FQDN Address**—FQDN Address Objects allow for the identification of a host by its Fully Qualified Domain Names (FQDN), such as www.sonicwall.com.

SonicOS provides a number of Default Address Objects that cannot be modified or deleted. You can use the Default Address Objects when creating a NAT policy, or you can create custom Address Objects to use. All Address Objects are available in the drop-down lists when creating a NAT policy.

Configuring Address Objects

The **Network > Address Objects** page allows you to create and manage your Address Objects. You can view Address Objects in the following ways using the **View Style** menu:

- **All Address Objects**—displays all configured Address Objects.
- **Custom Address Objects**—displays Address Objects with custom properties.
- **Default Address Objects**—displays Address Objects configured by default on the Dell SonicWALL appliance.

To add an Address Object:

1. Navigate to the **Network > Address Objects** page.
2. Below the Address Objects table, click **Add**.
3. In the Add Address Object dialog box, enter a name for the Address Object in the **Name** field.
4. Select the zone to assign to the Address Object from the **Zone Assignment** drop-down list.

5. Select **Host**, **Range**, **Network**, **MAC**, or **FQDN** from the **Type** menu.
 - If you selected **Host**, enter the IP address in the **IP Address** field.
 - If you selected **Range**, enter the starting and ending IP addresses in the **Starting IP Address** and **Ending IP Address** fields.
 - If you selected **Network**, enter the network IP address and netmask in the **Network** and **Netmask** fields.
 - If you selected **MAC**, enter the MAC address and netmask in the **Network** and **MAC Address** field.
 - If you selected **FQDN**, enter the domain name for the individual site or range of sites (with a wildcard) in the **FQDN** field.
6. Click **OK**.

Configuring NAT Policies

NAT policies allow you to control Network Address Translation based on matching combinations of Source IP address, Destination IP address and Destination Services. Policy-based NAT allows you to deploy different types of NAT simultaneously. The following NAT configurations are available in SonicOS:

- Many-to-One NAT Policy
- Many-to-Many NAT Policy
- One-to-One NAT Policy for Outbound Traffic
- One-to-One NAT Policy for Inbound Traffic (Reflexive)
- One-to-Many NAT Load Balancing
- Inbound Port Address Translation via One-to-One NAT Policy
- Inbound Port Address Translation via WAN IP Address

This section describes how to configure a One-to-One NAT policy. One-to-One is the most common NAT policy used to route traffic to an internal server, such as a Web Server. Most of the time, this means that incoming requests from external IPs are translated from the IP address of the Dell SonicWALL appliance WAN port to the IP address of the internal web server.

For other NAT configurations, see the *SonicOS Administrator's Guide*.

An example configuration illustrates the use of the fields in the Add NAT Policy procedure. To add a One-to-One NAT policy that allows all Internet traffic to be routed through a public IP address, two policies are needed: one for the outbound traffic, and one for the inbound traffic. To add both parts of a One-to-One NAT policy, perform the following steps:

1. Navigate to the **Network > NAT Policies** page. Click **Add**. The **Add NAT Policy** dialog box displays.
2. For **Original Source**, select **Any**.
3. For **Translated Source**, select **Original**.
4. For **Original Destination**, select **X0 IP**.
5. For **Translated Destination**, select **Create new address object** and create a new address object using **WAN** for Zone Assignment and **Host** for Type.
6. For **Original Service**, select **HTTP**.
7. For **Translated Service**, select **Original**.
8. For **Inbound Interface**, select **X0**.
9. For **Outbound Interface**, select **Any**.
10. For **Comment**, enter a short description.
11. Select the **Enable NAT Policy** checkbox.
12. Select the **Create a reflexive policy** checkbox if you want a matching NAT Policy to be automatically created in the opposite direction. This will create the outbound as well as the inbound policies.
13. Click **OK**.

Enabling Security Services in SonicOS

You must enable each security service individually in the SonicOS user interface. See the following procedures to enable and configure the following three basic security services:

Gateway Anti-Virus

Gateway Anti-Virus Global Settings

Enable Gateway Anti-Virus

Protocols	HTTP	FTP	IMAP	SMTP	POP3	CIFS/Netbios	TCP Stream
Enable Inbound Inspection	<input checked="" type="checkbox"/>	<input checked="" type="checkbox"/>	<input checked="" type="checkbox"/>	<input checked="" type="checkbox"/>	<input checked="" type="checkbox"/>	<input type="checkbox"/>	<input type="checkbox"/>
Enable Outbound Inspection	<input type="checkbox"/>	<input type="checkbox"/>	<input type="checkbox"/>	<input type="checkbox"/>	<input type="checkbox"/>	<input type="checkbox"/>	<input type="checkbox"/>
Protocol Settings	<input type="button" value="Settings"/>	<input type="button" value="Settings"/>	<input type="button" value="Settings"/>	<input type="button" value="Settings"/>	<input type="button" value="Settings"/>	<input type="button" value="Settings"/>	<input type="button" value="Settings"/>

Intrusion Prevention

IPS Global Settings

Enable IPS

Signature Groups	Prevent All	Detect All	Log Redundancy Filter (seconds)
High Priority Attacks	<input checked="" type="checkbox"/>	<input checked="" type="checkbox"/>	<input type="text" value="0"/>
Medium Priority Attacks	<input checked="" type="checkbox"/>	<input checked="" type="checkbox"/>	<input type="text" value="0"/>
Low Priority Attacks	<input type="checkbox"/>	<input checked="" type="checkbox"/>	<input type="text" value="60"/>

Anti-Spyware

Anti-Spyware Global Settings

Enable Anti-Spyware

Signature Groups	Prevent All	Detect All	Log Redundancy Filter
High Danger Level Spyware	<input checked="" type="checkbox"/>	<input checked="" type="checkbox"/>	<input type="text" value="0"/>
Medium Danger Level Spyware	<input checked="" type="checkbox"/>	<input checked="" type="checkbox"/>	<input type="text" value="0"/>
Low Danger Level Spyware	<input type="checkbox"/>	<input checked="" type="checkbox"/>	<input type="text" value="0"/>

For more information on configuring your security services, refer to the *SonicOS Administrator's Guide*.

Applying Security Services to Zones

A network zone is a logical group of one or more interfaces to which you can apply security rules to regulate traffic passing from one zone to another zone.

Security services such as Gateway Anti-Virus are automatically applied to the LAN and WAN network zones when you activate the license and enable the service. To protect other zones such as the **DMZ** or **Wireless LAN (WLAN)**, you must apply the security services to the network zones. For example, you can configure Dell SonicWALL Intrusion Prevention Service for incoming and outgoing traffic on the WLAN zone to add more security for internal network traffic.

To apply services to network zones:

1. Navigate to the **Network > Zones** page.
2. In the Zone Settings table, click the **Configure** icon for the zone where you want to apply security services.
3. In the Edit Zone dialog box on the **General** tab, select the checkboxes for the security services to enable on this zone.
4. On the Edit Zone page, select the checkboxes for the security services that you want to enable.
5. Click **OK**.
6. To enable security services on other zones, repeat steps 2 through 5 for each zone.

Troubleshooting Diagnostic Tools

SonicOS provides a number of diagnostic tools to help you maintain your network and troubleshoot problems. Several tools can be accessed on the **System > Diagnostics** page, and others are available on other screens.

This section contains the following subsections:

- [Using Ping](#) - page 53
- [Using the Connections Monitor](#) - page 53

Using Ping

Ping is available on the **System > Diagnostics** page.

The screenshot shows the 'System / Diagnostics' interface. At the top, there are 'Accept', 'Cancel', and 'Refresh' buttons. Below this is the 'Tech Support Report' section, which includes checkboxes for 'VPN Keys', 'ARP Cache', 'DHCP Bindings', and 'IKE Info', along with 'Download Report' and 'Send Diagnostic Reports' buttons. A checkbox for 'Enable Periodic Secure Backup of Diagnostic Reports to MySonicwall' is checked, with a 'Time Interval (minutes)' field set to '1440'. The 'Diagnostic Tools' section features a dropdown menu for 'Diagnostic Tool:' with 'Ping' selected. Below the dropdown is a 'Ping host or IP address:' field and a 'Go' button. The dropdown menu lists several tools: 'Ping', 'Connections Monitor', 'Multi-Core Monitor', 'Core Monitor', 'Link Monitor', 'Packet Size Monitor', 'DNS Name Lookup', 'Find Network Path', 'Ping', and 'Core 0 Process Monitor'.

The Ping test bounces a packet off a machine on the Internet and returns it to the sender. This test shows if the Dell SonicWALL appliance is able to contact the remote host. If users on the LAN are having problems accessing services on the Internet, try pinging the DNS server, or another machine at the ISP location. If the test is unsuccessful, try pinging devices outside the ISP. If you can ping devices outside of the ISP, then the problem lies with the ISP connection.

Using the Connections Monitor

The **Connections Monitor** displays real-time, exportable (plain text or CSV), filterable views of all connections to and through the Dell SonicWALL appliance. This tool is available on the **Systems > Diagnostics** page.

You can filter the results to display only connections matching certain criteria. You can filter by **Source IP, Destination IP, Destination Port, Protocol, Src Interface** and **Dst Interface**. Enter your filter criteria in the **Active Connections Monitor Settings** table.

The fields you enter values into are combined into a search string with a logical **AND**. Select the **Group Filters** box next to any two or more criteria to combine them with a logical **OR**.

In this Section:

This section provides overviews of customer support and training options for the Dell SonicWALL NSA E8510.

- [Customer Support](#) - page 55
- [Knowledge Portal](#) - page 55
- [User Forums](#) - page 56
- [Training](#) - page 57
- [Related Documentation](#) - page 58
- [Dynamic Tooltips](#) - page 59
- [Dell SonicWALL Live Product Demos](#) - page 59
- [Dell SonicWALL Secure Wireless Network Integrated Solutions Guide](#) - page 60

Customer Support

Designed for customers with Dell SonicWALL E-Class solutions, Dell SonicWALL E-Class Support 24x7 delivers the enterprise-class support features and quality of service that enterprise companies require to keep their networks running smoothly and efficiently. Dell SonicWALL E-Class Support 24x7 is an around-the-clock support service that includes phone, email and Web-based technical support, software and firmware updates and upgrades and Advance Exchange hardware replacement. Please Note: Continuous support is required on all E-Class products.

For further information, visit:

<http://www.sonicwall.com/us/en/support/contact.html>

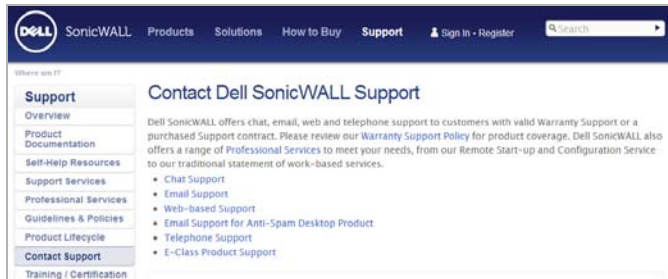

Knowledge Portal

The Knowledge Portal is a resource which allows users to search for Dell SonicWALL documents based on the following types of search tools:

- Browse
- Search for keywords
- Full-text search

For further information, visit:

<http://www.sonicwall.com/us/support/kb.asp>

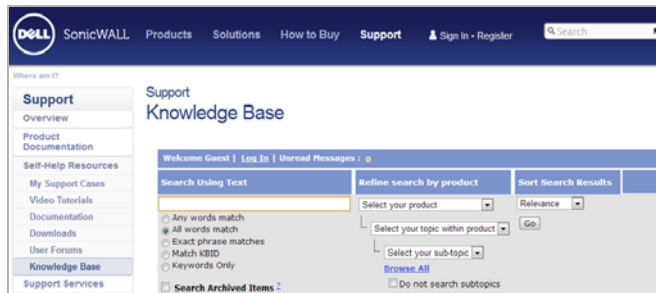

User Forums

The Dell SonicWALL User Forums is a resource that provides users the ability to communicate and discuss a variety of security and appliance subject matters. In this forum, the following categories are available for users:

- Content Security Manager topics
- Continuous Data Protection topics
- Email Security related topics
- Firewall related topics
- Network Anti-Virus related topics
- Security Services and Content Filtering topics
- GMS and Analyzer related topics
- SonicPoint and Wireless related topics
- SSL VPN related topics
- Wireless WAN - 3G/4G relates topics
- VPN Client related topics
- VPN site-to-site and interoperability topics

For further information, visit:

<https://forum.sonicwall.com/>

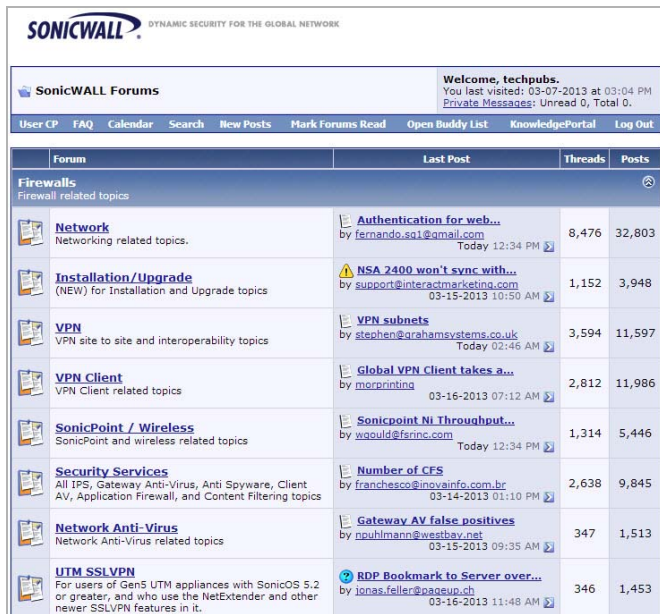

The screenshot shows the SonicWALL User Forums interface. At the top, there is a navigation bar with links for User CP, FAQ, Calendar, Search, New Posts, Mark Forums Read, Open Buddy List, KnowledgePortal, and Log Out. A welcome message for 'techpubs' is displayed, along with the last visit date (03-07-2013 at 03:04 PM) and private message status (Unread 0, Total 0).

The main content area displays a list of forum topics under the 'Firewalls' category. The table below summarizes the visible data:

Forum	Last Post	Threads	Posts
Network Networking related topics.	Authentication for web... by fernando.spl@gmail.com Today 12:34 PM	8,476	32,803
Installation/Upgrade (NEW) for Installation and Upgrade topics	NSA 2400 won't sync with... by support@interactmarketina.com 03-15-2013 10:50 AM	1,152	3,948
VPN VPN site to site and interoperability topics	VPN subnets by stephen@arahamsystems.co.uk Today 02:46 AM	3,594	11,597
VPN Client VPN Client related topics	Global VPN Client takes a... by morprinting 03-16-2013 07:12 AM	2,812	11,986
SonicPoint / Wireless SonicPoint and wireless related topics	Sonicpoint Ni Throughput... by wgauld@frinc.com Today 12:34 PM	1,314	5,446
Security Services All IPS, Gateway Anti-Virus, Anti Spyware, Client AV, Application Firewall, and Content Filtering topics	Number of CFS by francesco@inovainfo.com.br 03-14-2013 01:10 PM	2,638	9,845
Network Anti-Virus Network Anti-Virus related topics	Gateway AV false positives by ppuhlmann@westbay.net 03-15-2013 09:35 AM	347	1,513
UTM SSLVPN For users of Gen5 UTM appliances with SonicOS 5.2 or greater, and who use the NetExtender and other newer SSLVPN features in it.	RDP Bookmark to Server over... by jonas.feller@paagup.ch 03-16-2013 11:48 AM	346	1,453

Training

Dell SonicWALL offers an extensive sales and technical training curriculum for Network Administrators, Security Experts and SonicWALL Medallion Partners who need to enhance their knowledge and maximize their investment in Dell SonicWALL Products and Security Applications. Dell SonicWALL Training provides the following resources for its customers:

- E-Training
- Instructor-Led Training
- Custom Training
- Technical Certification
- Authorized Training Partners

For further information, visit:

<http://training.sonicwall.com/>

The screenshot shows the Dell SonicWALL website's 'Training and Certification' page. The navigation bar includes 'Dell SonicWALL', 'Products', 'Solutions', 'How to Buy', 'Support', and 'Sign In - Register'. A search bar is located on the right. The main content area is titled 'Training and Certification' and contains the following sections:

- Support**: Overview, Product Documentation, Self-Help Resources, Support Services, Professional Services Guidelines & Policies, Product Lifecycle, Contact Support, Training / Certification, Overview.
- Instructor-led Courses**: Dell provides instructor-led courses and technical eLearning modules designed to supply you with extensive technology foundations, in-depth knowledge specific to Dell SonicWALL products, in addition to online practice and an array of supplemental resources to enhance learning.
- eLearning Courses**: Dell offers a wide-range of high-quality, in-depth eLearning courses. Each course is designed to teach you key security technology fundamentals, along with specific Dell SonicWALL product design, configuration, implementation and troubleshooting topics. Each Technical eLearning course is self-paced (approximately 6-8 hours). However, courses do not need to be completed in one session. You have unlimited access to all Dell SonicWALL eLearning courses.
- Authorized Training Partners**: Dell Authorized Training Partners (ATPs) deliver a variety of educational programs to meet the many learning methods that each individual prefers.

Related Documentation

See the following related documents for more information:

- SonicOS Administrator's Guide
- SonicOS Release Notes
- SonicOS Feature Modules
 - Application
 - Dashboard
 - HA License Sync
 - Multiple Admin
 - NAT Load Balancing
 - Packet Capture
 - RF Management
 - Single Sign On
 - SSL Control
 - Virtual Access Points
- Dell SonicWALL GVC Administrator's Guide
- Dell SonicWALL Analyzer Administrator's Guide
- Dell SonicWALL GAV Administrator's Guide
- Dell SonicWALL IPS Administrator's Guide
- Dell SonicWALL Anti-Spyware Administrator's Guide
- Dell SonicWALL CFS Administrator's Guide

For further information, visit:

<http://www.sonicwall.com/support.html>

The screenshot shows the Dell SonicWALL Product Support website. The top navigation bar includes the Dell logo, SonicWALL, Products, Solutions, How to Buy, Support, Sign In, and Register. A search bar is located in the top right corner. The left sidebar contains a 'Support' menu with options: Overview, Product Documentation, Network Security, SuperMassive Series, NSA E-Class Series (selected), NSA Series, PRO Series, TZ Series, WSA Series, SonicPoint Series, Gateway Anti-Virus, Anti-Spyware & Intrusion Prevention, SSL VPN Secure Remote Access, Email Security Appliances and Software, Management & Reporting, Backup & Recovery, Content Security Management, Client Software, Legacy Products, Self-Help Resources, Support Services, Professional Services, Guidelines & Policies, Product Lifecycle, Contact Support, and Training / Certification. The main content area is titled 'Product Support' and features a banner for 'E-Class NSA Series Appliances' with an image of a server rack. Below the banner, there are two tabs: 'Support Documents' (selected) and 'Knowledge Base'. The 'Support Documents' section includes a 'List View Options' filter, a 'Categories' list with checkboxes for Product Guides, Technical Notes, FAQs, Release Notes, and Support Data Sheets, and two sections: 'Product Guides' (6 of 59 items) and 'Technical Notes' (6 of 46 items). The Product Guides list includes items like 'SonicWALL Mobile Connect for Android 2.0 User Guide' (19 Feb 2013), 'SonicWALL Mobile Connect for Apple iOS 2.0 User Guide' (19 Feb 2013), 'SonicOS 5.8.1 Rev F Administrator's Guide' (13 Feb 2013), 'SonicOS 5.8.1 Log Events Reference Guide' (23 Oct 2012), 'SonicOS Enhanced 5.5 Layer 2 Bridge Bypass Feature Module' (18 May 2012), and 'SonicOS 5.8.1 Rev E Administrator's Guide' (19 Apr 2012). The Technical Notes list includes 'Integrating CradlePoint with SonicOS 5.9' (16 Nov 2012), 'Integrating Agilink with SonicOS 5.9' (16 Nov 2012), and 'Configuring SonicOS 5.8.1-8 for Amazon VPC Tech Note' (8 Oct 2012).

Dynamic Tooltips

SonicOS features dynamic tooltips that appear over various elements of the GUI when the mouse hovers over them. Elements that display these tooltips include text fields, radio buttons, and checkboxes.

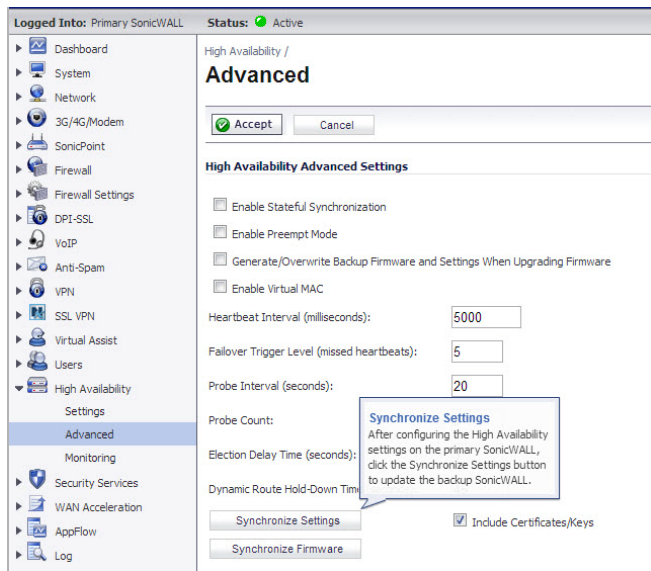

Dell SonicWALL Live Product Demos

The Dell SonicWALL Live Demo Site provides free test drives of Dell SonicWALL security products and services through interactive live product installations:

- Network Security Appliance Platform
- Secure Cellular Wireless
- Continuous Data Protection
- SSL VPN Secure Remote Access
- Content Filtering
- Secure Wireless Solutions
- Email Security
- GMS, ViewPoint, and Analyzer

For further information, visit: <http://livedemo.sonicwall.com/>



Dell SonicWALL Secure Wireless Network Integrated Solutions Guide

Looking to go wireless? Have questions about what it takes to build a truly “secure” wireless network? Check out the Dell SonicWALL Secure Wireless Network Integrated Solutions Guide. This book is the official guide to Dell SonicWALL’s market-leading wireless networking and security devices.

This title is available in hardcopy at fine book retailers everywhere, or by ordering directly from Elsevier Publishing at: <http://www.elsevier.com>

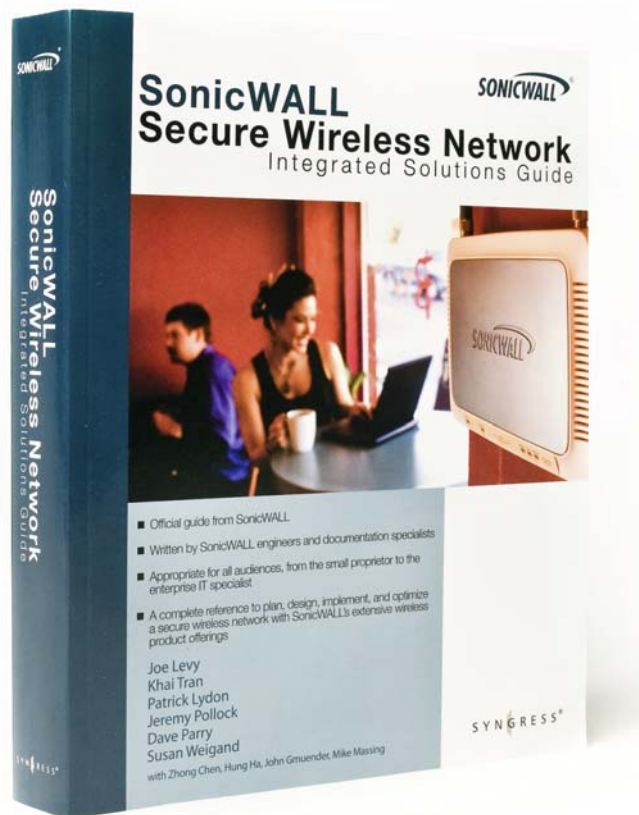

- Official guide from SonicWALL
- Written by SonicWALL engineers and documentation specialists
- Appropriate for all audiences, from the small proprietor to the enterprise IT specialist
- A complete reference to plan, design, implement, and optimize a secure wireless network with SonicWALL's extensive wireless product offerings

Joe Levy
Khal Tran
Patrick Lydon
Jeremy Pollock
Dave Parry
Susan Weigand
with Zhong Chen, Hung Ha, John Gruender, Mike Masling

SYN PRESS®

In this Section:

This section provides illustrated rack mounting instructions for the Dell SonicWALL NSA E8510.

- [Rack Mounting Instructions](#) - page 63



Note: For more information on rack mounting requirements, see the [Safety and Regulatory Information](#) section, on page 69.

Rack Mounting Instructions

Assemble the Slide Rail

Fasten 4 screws to the rail.

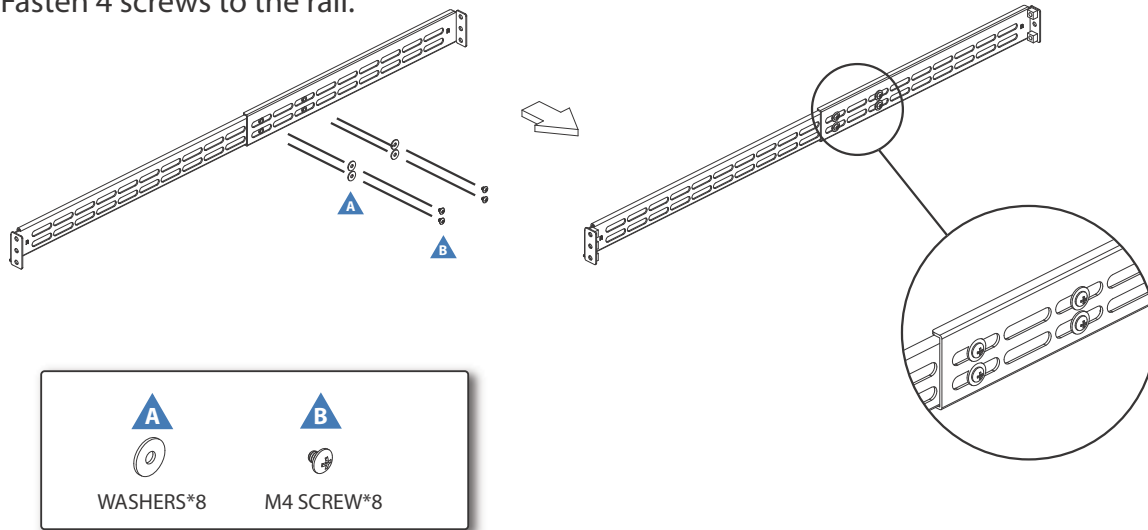

Assemble the Slide Rail

Fasten two-sided screws to the rail.

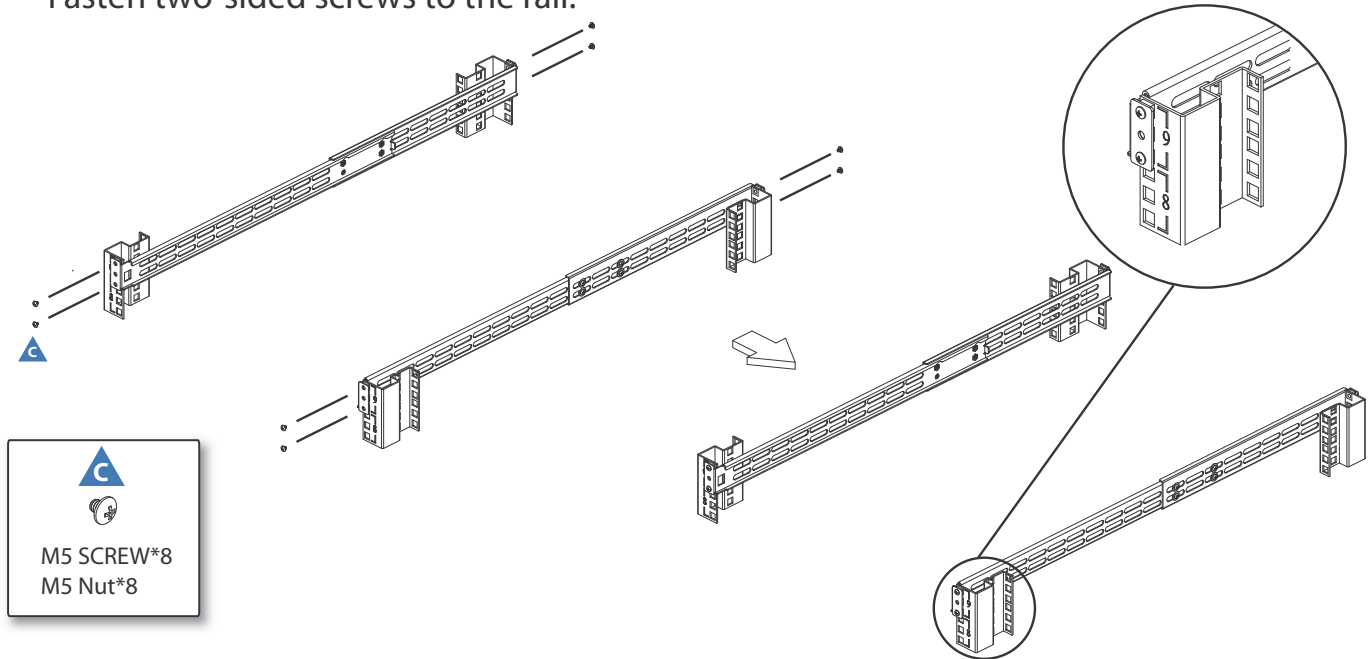

Assemble Inner Rail to Chassis

Fasten 6 screws to attach the inner channel onto the chassis.

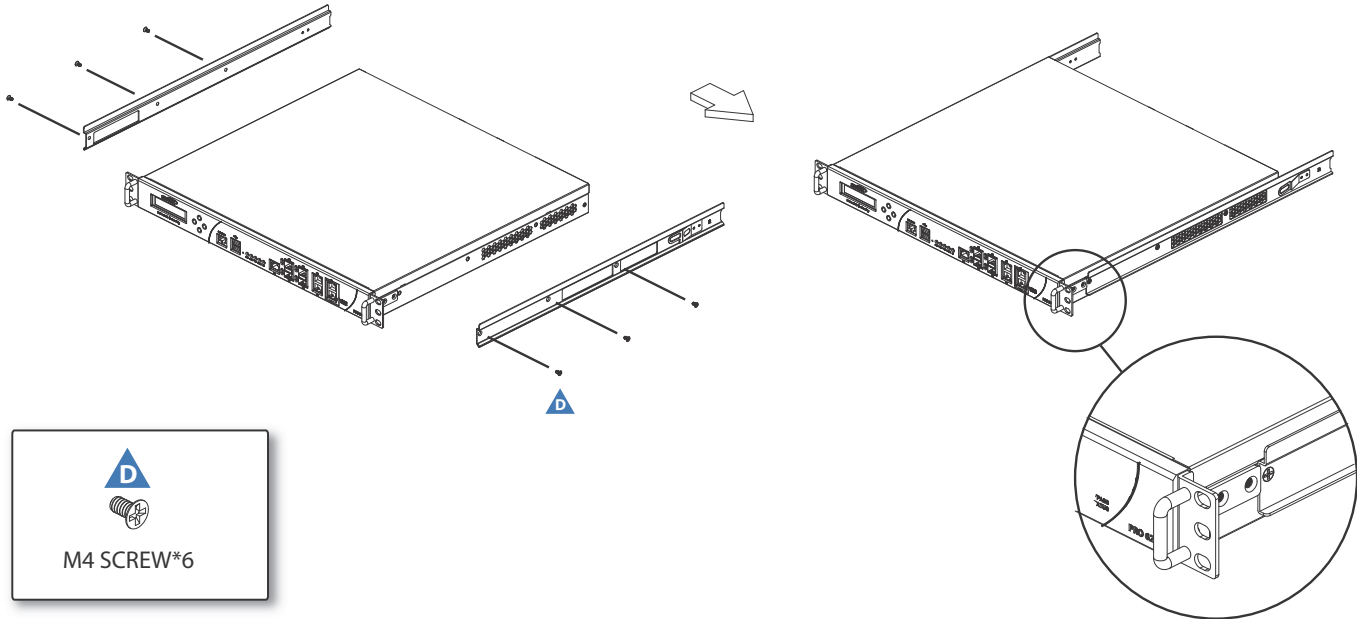

Insert Chassis to Frame

Slide inner channel into rails.

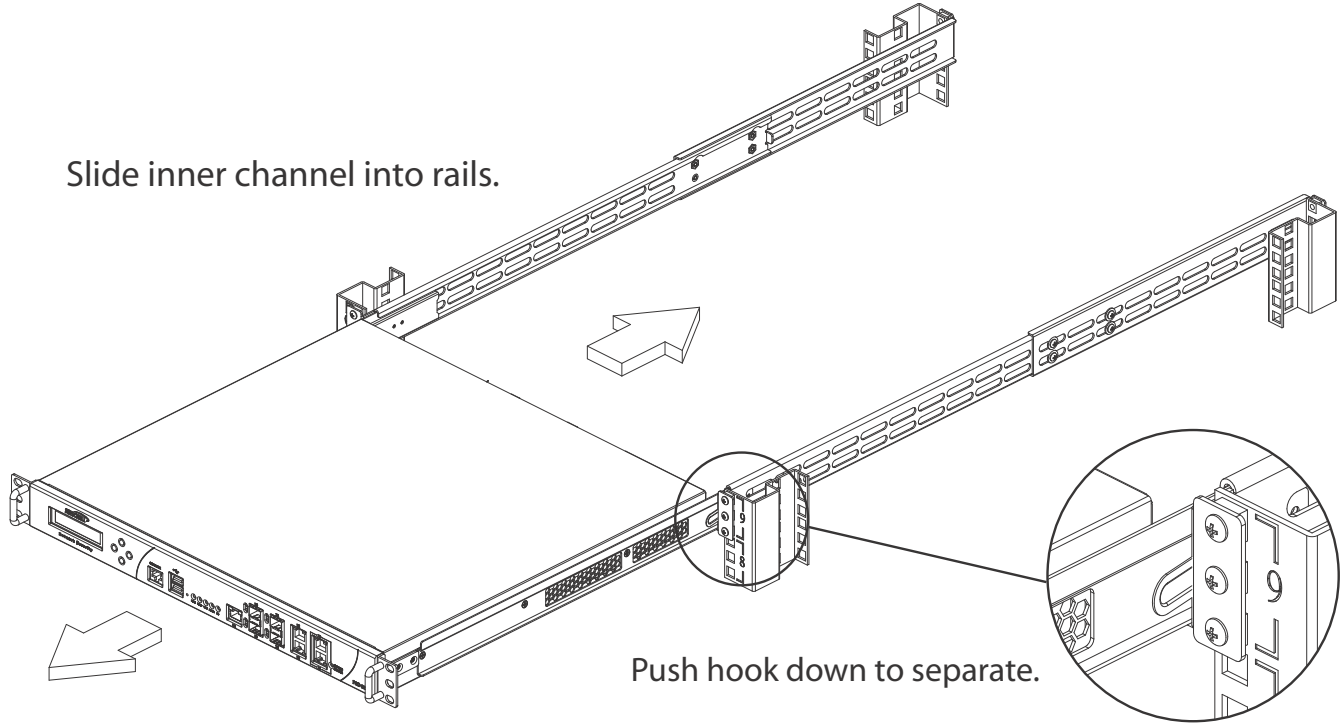

Push hook down to separate.

In this Section:

This section provides regulatory along with trademark and copyright information.

- [Safety and Regulatory Information](#) - page 69
- [Warranty Information](#) - page 73
- [Copyright Notice](#) - page 73

Safety and Regulatory Information

Regulatory Model/Type	Product Name
1RK15-08D	NSA E8510

Safety Instructions

The following conditions are required for proper installation:

- The Dell SonicWALL appliance is designed to be mounted in a standard 19-inch rack mount cabinet.
- Use the mounting hardware recommended by the rack manufacturer and ensure that the rack is adequate for the application.
- Ensure that no water or excessive moisture can enter the unit.
- Allow unrestricted airflow around the unit and through the vents on the side of the unit. A minimum of 1 inch (25.4mm) clearance is recommended.
- Route cables away from power lines, fluorescent lighting fixtures, and sources of noise such as radios, transmitters, and broadband amplifiers.
- This product is not intended to be installed and used in a home or public area accessible to the general population. When installed in schools, this equipment must be installed in a secure location accessible only by trained personnel.
- Mount in a location away from direct sunlight and sources of heat. A maximum ambient temperature of 104° F (40° C) is recommended.
- If installed in a closed or multi-rack assembly, the operating ambient temperature of the rack environment may be greater than the room ambient. Therefore, consideration should be given to installing the equipment in an environment compatible with the maximum recommended ambient temperature.
- Mount the Dell SonicWALL appliances evenly in the rack in order to prevent a hazardous condition caused by uneven mechanical loading.
- Four mounting screws, compatible with the rack design, must be used and hand-tightened to ensure secure installation. Choose a mounting location where all four mounting holes line up with those of the mounting bars of the 19-inch rack mount cabinet.
- A suitably rated and approved branch circuit breaker shall be provided as part of the building installation. Follow local code when purchasing materials or components.
- Consideration must be given to the connection of the equipment to the supply circuit. Appropriate consideration of equipment nameplate ratings must be used when addressing this concern. Do not overload the circuit.

- Reliable grounding of rack-mounted equipment must be maintained. Particular attention must be given to power supply connections other than direct connections to the branch circuits, such as power strips.
- As shipped from the factory this Dell SonicWALL product includes two power supplies for redundant AC power and added reliability. A field conversion is available to convert to DC mains.
- To disconnect AC power, both power cords must be removed.
- The included power cord(s) are approved for use only in specific countries or regions. Before using a power cord, verify that it is rated and approved for use in your location.
- This model is shipped as AC mains configuration using standard 3 conductor appliance couplers. A field conversion is available to change to DC mains. The DC mains connector is a keyed square 6-pin conductor with two blank locations.
- To disconnect DC power, an external properly-related disconnect device must be provided by building or rack installation.
- Do not connect AC configured products to DC mains, and do not connect DC configured products to AC. Detailed instructions are provided with the DC conversion kit. Product must be configured as all DC or all AC.
- DC rating includes tolerances. Do not operate product outside of range shown on product label.
- DC configuration includes input cable with protective earthing conductor (Green and Yellow wire). This conductor is required to be connected to safety earth ground of circuit.
- Never remove or install a power supply with the AC or DC power cord attached to the power supply being removed or installed.
- Thumbscrews should be tightened with a tool after both installation and subsequent access to the rear of the product.



Warning—Potential Hazard from Fan

- Before replacing the fan unit, carefully read and follow the instructions provided with the unit.

Lithium Battery Warning

The Lithium Battery used in the Dell SonicWALL Internet security appliance may not be replaced by the user. The appliance must be returned to a Dell SonicWALL authorized service center for replacement with the same or equivalent type recommended by the manufacturer. If, for any reason, the battery or Dell SonicWALL Internet security appliance must be disposed of, do so following the battery manufacturer's instructions.

Cable Connections

All Ethernet and RS232 (Console) cables are designed for intra-building connection to other equipment. Do not connect these ports directly to communication wiring or other wiring that exits the building where the Dell SonicWALL is located.

Sicherheitsanweisungen

Für eine ordnungsgemäße Montage sollten die folgenden Hinweise beachtet werden:

- Das Dell SonicWALL Modell ist für eine Montage in einem standardmäßigen 19-Zoll-Rack konzipiert.
- Vergewissern Sie sich, dass das Rack für dieses Gerät geeignet ist und verwenden Sie das vom Rack-Hersteller empfohlene Montagezubehör.
- Stellen Sie sicher, dass das Gerät vor Wasser und hoher Luftfeuchtigkeit geschützt ist.
- Stellen Sie sicher, dass die Luft um das Gerät herum zirkulieren kann und die Lüftungsschlitze an der Seite des Gehäuses frei sind. Hier ist ein Belüftungsabstand von mindestens 26 mm einzuhalten.
- Achten Sie darauf, dass sich die Netzkabel nicht in der unmittelbaren Nähe von Stromleitungen, Leuchtstoffröhren und Störquellen wie Funksendern oder Breitbandverstärkern befinden
- Dieses Produkt ist nicht dafür entwickelt, um in Bereichen mit öffentlichem Zugang betrieben zu werden. Wenn es in Schulen betrieben wird, stellen Sie sicher, dass das Gerät in einem abgeschlossenen Raum installiert wird, der nur von speziell ausgebildetem Personal betreten werden kann.
- Wählen Sie für die Montage einen Ort, der keinem direkten Sonnenlicht ausgesetzt ist und sich nicht in der Nähe von Wärmequellen befindet. Die Umgebungstemperatur darf nicht mehr als 40 °C betragen.
- Wenn das Gerät in einem geschlossenen 19"-Gehäuse oder mit mehreren anderen Geräten eingesetzt ist, wird die Temperatur in der Gehäuse höher sein als die Umgebungstemperatur. Achten Sie darauf, daß die Umgebungstemperatur nicht mehr als 40° C beträgt.
- Bringen Sie die Dell SonicWALL waagrecht im Rack an, um mögliche Gefahren durch ungleiche mechanische Belastung zu vermeiden.

- Verwenden Sie für eine sichere Montage vier passende Befestigungsschrauben, und ziehen Sie diese mit der Hand an. Wählen Sie einen Ort im 19-Zoll-Rack, wo alle vier Befestigungen der Montageschienen verwendet werden.
- Ein angemessen dimensionierter und geprüfte Sicherung, sollte Bestandteil der Haus-Installation sein. Bitte folgen die den lokalen Richtlinien beim Einkauf von Material oder Komponenten.
- Prüfen Sie den Anschluss des Geräts an die Stromversorgung, damit der Übersromschutz sowie die elektrische Leitung nicht von einer eventuellen Überlastung der Stromversorgung beeinflusst werden. Prüfen Sie dabei sorgfältig die Angaben auf dem Aufkleber des Geräts. Überlasten Sie nicht den Stromkreis.
- Eine sichere Erdung der Geräte im Rack muss gewährleistet sein. Insbesondere muss auf nicht direkte Anschlüsse an Stromquellen geachtet werden wie z. B. bei Verwendung von Mehrfachsteckdosen.
- Dieses Produkt wird mit zwei Wechselstrom-Netzteilen zur redundanten Stromversorgung fuer erhöhte Verfü'gbarkeit ausgeliefert. Ein Umbaukit in Gleichstromversorgung ist verfü'gbar
- Um den Wechselstrom (AC) zu unterbrechen muessen beide Stromkabel entfernt werden.
- Das im Lieferumfang enthaltene bzw. die im Lieferumfang enthaltenen Netzkabel sind nur für die Verwendung in bestimmten Ländern und Regionen zugelassen. Überprüfen Sie bitte vor der Verwendung eines Netzkabels, ob es für die Verwendung in Ihrem Land oder Ihrer Region zugelassen ist und den geforderten Normen entspricht.
- Die Wechselstrom Konfiguration verwendet standardisierte Kaltgerätekabel. Sie können einem Umbaukit für Gleichstrom bestellen. Der Gleichstromanschluss ist ein quadratischer 6-adriger Anschluss mit zwei blinden Punkten.
- Um den Gleichstrom (DC) zu unterbrechen, muss ein externes, ordnungsgemäss bewertetes Unterbrechungsgeraet durch die Stromzufuhr im Gebäude oder das Rack zur Verfügung gestellt werden.
- Schließen Sie kein Wechselstrom konfiguriertes Produkt an Gleichstrom an. Und schließen Sie kein Gleichstrom konfiguriertes Produkt an Wechselstrom an. Das Umbaukit beinhaltet eine detaillierte Beschreibung. Das Gerät muss komplett mit Gleichstrom oder Wechselstrom konfiguriert sein.
- Gleichstrom akzeptiert Toleranzen. Betreiben Sie das Gerät nicht außerhalb des Bereiches, der auf dem Aufkleber des Gerätes angegeben ist.
- Die Gleichstrom Konfiguration beinhaltet einen Anschlusskabel mit Erdung (Grün-Gelbes Kabel). Diese Kabel muss an den Erdungsschaltkreis angeschlossen werden.
- Wenn Sie das Netzteil wechseln, entfernen Sie unbedingt die Stromversorgung von dem zu wechselnden Netzteil.
- Vergewissern Sie sich, dass die Schrauben nach dem Austausch mit entsprechendem Werkzeug fest angezogen werden.



Achtung—Lüfter Potentielle Gefahrenquelle

- Lesen Sie vor dem Austausch der Lüfereinheit die Anleitung, die mit dem Gerät geliefert wurde und befolgen Sie die Anweisungen.

Hinweis zur Lithiumbatterie

Die in der Internet Security Appliance von Dell SonicWALL verwendete Lithiumbatterie darf nicht vom Benutzer ausgetauscht werden. Zum Austauschen der Batterie muss die Dell SonicWALL in ein von Dell SonicWALL autorisiertes Service-Center gebracht werden. Dort wird die Batterie durch denselben oder entsprechenden, vom Hersteller empfohlenen Batterietyp ersetzt. Beachten Sie bei einer Entsorgung der Batterie oder der Dell SonicWALL Internet Security Appliance die diesbezüglichen Anweisungen des Herstellers.

Kabelverbindungen

Alle Ethernet- und RS232-C-Kabel eignen sich für die Verbindung von Geräten in Innenräumen. Schließen Sie an die Anschlüsse der Dell SonicWALL keine Kabel an, die aus dem Gebäude in dem sich das Gerät befindet herausgeführt werden.

安全說明

需要滿足以下條件以進行正確安裝：

- 戴爾 SonicWALL 設備被設計成安裝在一個標準的 19 吋機架安裝櫃。需要滿足以下條件以進行正確安裝：
- 使用機架製造商推薦的裝載硬體，確認機架足夠裝置所需
- 請確認裝置內不會滲入水分或過多的濕氣。
- 裝置週邊請保持通風，特別是裝置通風口側。建議裝置與牆壁間至少要有 1 英吋 (25.44 公釐) 的淨空。
- 纜線的路徑應遠離電源線、日光燈，以及會產生雜訊的來源，如無線電、發送器與寬頻放大器。

- 本產品的設計目的不是安裝並使用於住家或一般大眾可接觸到的公共區域。如果是安裝在學校，本設備只能安裝在受訓人員能接觸到的安全位置。
- 架設位置需遠離陽光直射與熱源。建議周圍溫度最高溫不要超過 104°F (40°C)。
- 如果是安裝於封閉式或多組機架配件，機架環境的周圍操作溫度可能會高過室內周遭。因此，在與上述建議之最高周圍溫度相容的環境中安裝設備時，應將此列入考量。
- 將戴爾 SonicWALL 裝置平坦地裝設在機架中，如此才能避免因不均勻的機械負荷造成危險狀況。
- 必須使用四顆與機架設計相容的安裝螺釘，並用手鎖緊螺釘，確定安裝牢固。選擇一個安裝位置，將四個裝載洞孔對齊 19 吋架設機櫃的安裝桿。
- 應當提供一個合適額定值並且已被認可的分支電路斷路器作為安裝該裝置的一部分。在購買材料或部件時，應遵循當地安全代碼。
- 必須留心裝置與電源電路的連接問題，電路過載對過電流保護與電路電線的影響需降至最低。解決這個問題時，需正確考慮裝置銘牌額定值。不要過載電路。
- 必須維護可靠的機架裝載設備接地。必須特別留意電源供應器連線，而不是直接連接到電源板之類的分支電路。
- 從工廠運出時，這個戴爾 SonicWALL 產品包括為後備交流電源和增加可靠性而附帶的兩個電源。可用提供的地區電流轉換器轉換成直流電源。
- 要斷開交流電源，兩條電源線都必須被拔除。
- 隨附的電源線僅限於特定的國家或地區使用。使用前，請確認電源線的額定值且已被認可可在你的地區上使用。

- 這個型號出貨時附帶的交流電源，是標準三芯器具耦合器的配置。可用提供的地區電流轉換器轉換成直流電源。直流（DC）電源連接器為具有特定方向連接的方形連接器，帶六芯接頭以及兩個空白位置。
- 要斷開直流電源，必須有一個由建築物本身或機架安裝所提供的外部適當的額定斷路裝置。
- 不要把交流配置的產品連接到直流電源，也不要將直流配置的產品連接到交流電源。在直流轉換器套件中有詳細說明。產品必須設定為全直流或全交流。
- 直流讀數包括公差。不要在產品標籤標示的範圍以外操作產品。
- 直流配置包括帶有保護接地導體的輸入電纜（綠色和黃色電線）。此導體必須連接到安全接地電路。
- 切勿在交流電源線還連接著電源時移除或安裝電源。
- 當安裝及後續接觸產品背面之後，必須用工具將指旋螺釘鎖緊。



風扇潛在危險警告

- 更換風扇部件前，請仔細閱讀，並遵循所提供的指示。

鋰電池警告

使用者不得自行更換 戴爾 SonicWALL 網際網路安全性裝置中使用的鋰電池。必須將 戴爾 SonicWALL 送回 戴爾 SonicWALL 授權的服務中心，以更換相同的鋰電池或製造商推薦的同類型鋰電池。若因任何原因必須丟棄電池或 戴爾 SonicWALL 網際網路安全性裝置，請嚴格遵守電池製造商的指示。

纜線連結

所有乙太網路與 RS232（主控台）線路都是為與其他裝置進行內建連接所設計的。請不要將這些連接埠直接連接至通訊線路，或其他連出 戴爾 SonicWALL 所在建築的線路。

FCC Part 15 Class A Notice

NOTE: This equipment was tested and found to comply with the limits for a Class A digital device, pursuant to Part 15 of the FCC Rules. These limits are designed to provide reasonable protection against harmful interference when the equipment is operated in a commercial environment. This equipment generates, uses, and can radiate radio frequency energy. And if not installed and used in accordance with the instruction manual, the device may cause harmful interference to radio communications. Operation of this equipment in a residential area is likely to cause harmful interference in which case the user is required to correct the interference at his own expense.

Caution: *Modifying this equipment or using this equipment for purposes not shown in this manual without the written consent of Dell, Inc. could void the user's authority to operate this equipment.*

BMSI Statement

警告使用者：

此為甲類資訊技術設備，於居住環境中使用時，可能會造成射頻擾動，在此種情況下，使用者會被要求採取某些適當的對策。

VCCI Statement

この装置は、クラスA情報技術装置です。この装置を家庭環境で使用すると電波妨害を引き起こすことがあります。この場合には使用者が適切な対策を講ずるよう要求されることがあります。

VCCI - A

Canadian Radio Frequency Emissions Statement

This Class A digital apparatus complies with Canadian ICES-003.
Cet appareil numérique de la classe A est conforme à toutes la norme NMB-003 du Canada.

Complies with EN 55022 Class A and CISPR22 Class A

Warning: This is a class A product. In a domestic environment, this product may cause radio interference in which case the user may be required to take adequate measures.

Declaration of Conformity
Application of council Directive 2004/108/EC (EMC) and 2006/95/EC (LVD)
Standards to which conformity is declared
EN 55022 (2006) +A1 (2007) Class A
EN 55024 (1998) +A1 (2001), +A2 (2003)
EN 61000-3-2 (2006)
EN 61000-3-3 (2008)
EN 60950-1 (2006) +A11

National Deviations: AR, AT, AU, BE, BR, CA, CH, CN, CZ, DE, DK, FI, FR, GB, GR, HU, IL, IN, IT, JP, KE, KR, MY, NL, NO, PL, SE, SG, SI, SK, US

Regulatory Information for Korea

	Ministry of Information and Telecommunication Certification Number SWL-1RK15-055
---	---

All products with country code "A" and "J" are made in the USA.
All products with country code "B" are made in China.
All products with country code "C" or "D" are made in Taiwan R.O.C.
All certificates held by Secuwide, Corps.

A급 기기 (업무용 정보통신기기)

이 기기는 업무용으로 전자파적합등록을 한 기기이오니 판매자 또는 사용자는 이 점을 주의하시기 바라며, 만약 잘못판매 또는 구입하였을 때에는 가장용으로 교환하시기 바랍니다.

Warranty Information

All Dell SonicWALL appliances come with a 1-year Limited Hardware Warranty which provides delivery of critical replacement parts for defective parts under warranty. Visit the Warranty Information page details on your product's warranty: <http://www.sonicwall.com/us/en/support/Services.html#tab=warranty>

Copyright Notice

© 2013 Dell, Inc.

All rights reserved.

Under the copyright laws, this manual or the software described within, cannot be copied, in whole or part, without the written consent of the manufacturer, except in the normal use of the software to make a backup copy. The same proprietary and copyright notices must be affixed to any permitted copies as were affixed to the original. This exception does not allow copies to be made for others, whether or not sold, but all of the material purchased (with all backup copies) can be sold, given, or loaned to another person. Under the law, copying includes translating into another language or format.

Specifications and descriptions subject to change without notice.

Free Manuals Download Website

<http://myh66.com>

<http://usermanuals.us>

<http://www.somanuals.com>

<http://www.4manuals.cc>

<http://www.manual-lib.com>

<http://www.404manual.com>

<http://www.luxmanual.com>

<http://aubethermostatmanual.com>

Golf course search by state

<http://golfingnear.com>

Email search by domain

<http://emailbydomain.com>

Auto manuals search

<http://auto.somanuals.com>

TV manuals search

<http://tv.somanuals.com>