

Dell PowerEdge R420 Getting Started Guide

Regulatory Model: E18S Series
Regulatory Type: E18S001



Notes, Cautions, and Warnings



NOTE: A NOTE indicates important information that helps you make better use of your computer.



CAUTION: A CAUTION indicates either potential damage to hardware or loss of data and tells you how to avoid the problem.



WARNING: A WARNING indicates a potential for property damage, personal injury, or death.

© 2012 Dell Inc.

Trademarks used in this text: Dell™, the Dell logo, Dell Boomi™, Dell Precision™, OptiPlex™, Latitude™, PowerEdge™, PowerVault™, PowerConnect™, OpenManage™, EqualLogic™, Compellent™, KACE™, FlexAddress™, Force10™ and Vostro™ are trademarks of Dell Inc. Intel®, Pentium®, Xeon®, Core® and Celeron® are registered trademarks of Intel Corporation in the U.S. and other countries. AMD® is a registered trademark and AMD Opteron™, AMD Phenom™ and AMD Sempron™ are trademarks of Advanced Micro Devices, Inc. Microsoft®, Windows®, Windows Server®, Internet Explorer®, MS-DOS®, Windows Vista® and Active Directory® are either trademarks or registered trademarks of Microsoft Corporation in the United States and/or other countries. Red Hat® and Red Hat® Enterprise Linux® are registered trademarks of Red Hat, Inc. in the United States and/or other countries. Novell® and SUSE® are registered trademarks of Novell Inc. in the United States and other countries. Oracle® is a registered trademark of Oracle Corporation and/or its affiliates. Citrix®, Xen®, XenServer® and XenMotion® are either registered trademarks or trademarks of Citrix Systems, Inc. in the United States and/or other countries. VMware®, Virtual SMP®, vMotion®, vCenter® and vSphere® are registered trademarks or trademarks of VMware, Inc. in the United States or other countries. IBM® is a registered trademark of International Business Machines Corporation.

2012 – 10

Rev. A01

Installation And Configuration

 **WARNING:** Before performing the following procedure, review the safety instructions that came with the system.

Unpacking A Rack System

Unpack your system and identify each item.

Assemble the rails and install the system in the rack following the safety instructions and the rack installation instructions provided with your system.

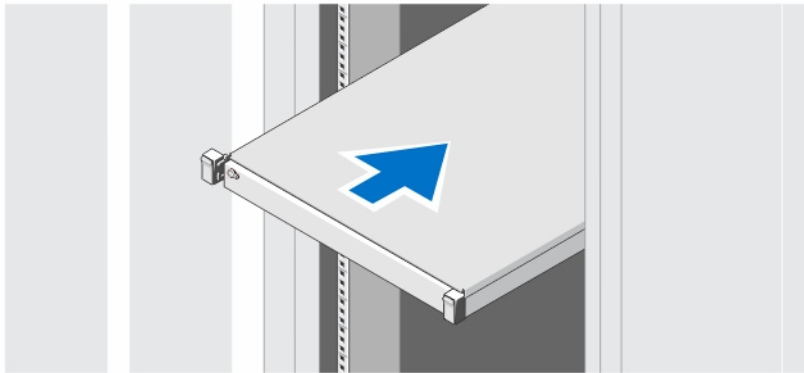

Figure 1. Installing the Rails and System in a Rack

Optional—Connecting The Keyboard, Mouse, And Monitor

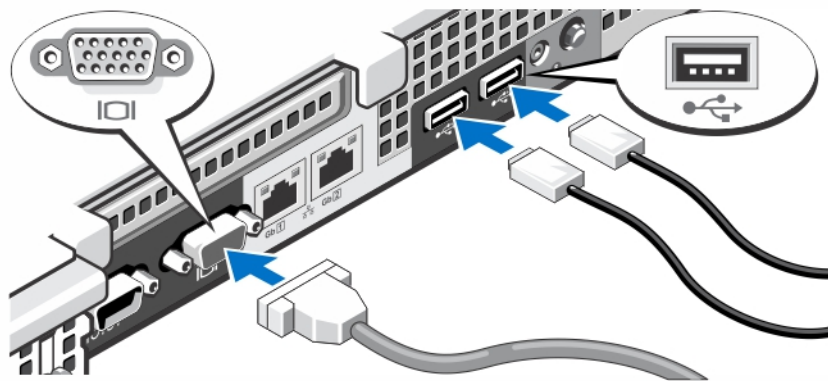

Figure 2. Optional—Connecting the Keyboard, Mouse, and Monitor

Connect the keyboard, mouse, and monitor (optional).

The connectors on the back of your system have icons indicating which cable to plug into each connector. Be sure to tighten the screws (if any) on the monitor's cable connector.

Connecting The Power Cable(s)

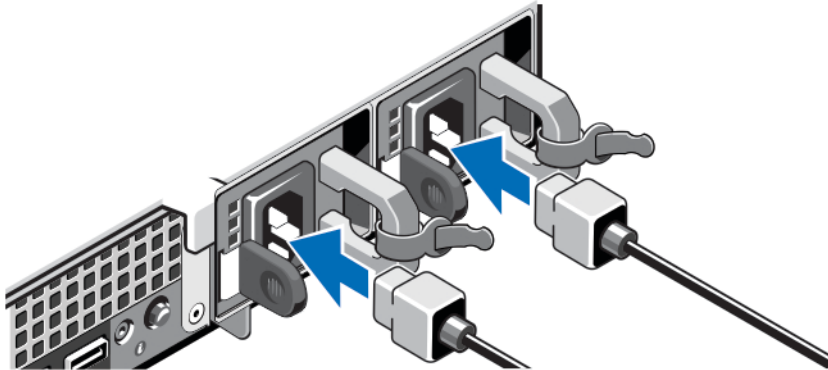

Figure 3. Connecting the Power Cable(s)

Connect the system's power cable(s) to the system and, if a monitor is used, connect the monitor's power cable to the monitor.

Securing The Power Cable(s)

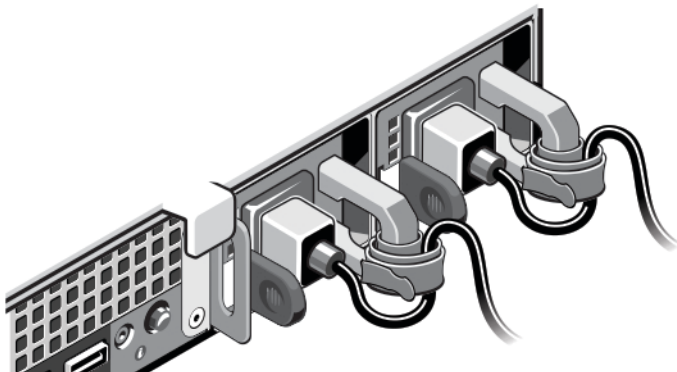

Figure 4. Securing the Power Cable(s)

Bend the system power cable(s), as shown in the illustration, and attach to the cable strap.

Plug the other end of the power cable(s) into a grounded electrical outlet or a separate power source such as an uninterruptible power supply (UPS) or a power distribution unit (PDU).

Turning On The System

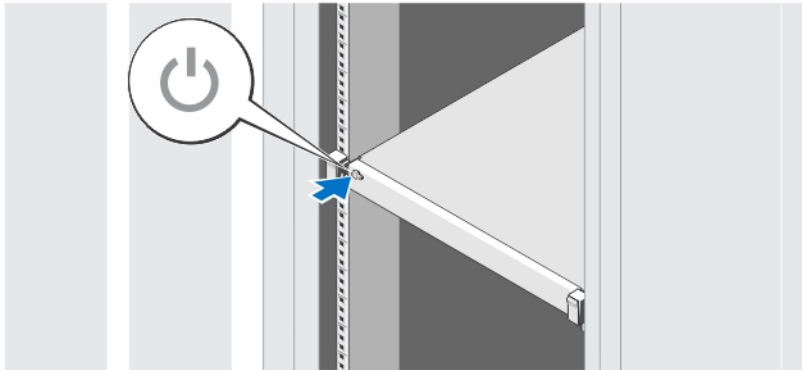

Figure 5. Turning on the System

Press the power button on the system. The power indicator should light.

Installing The Optional Bezel

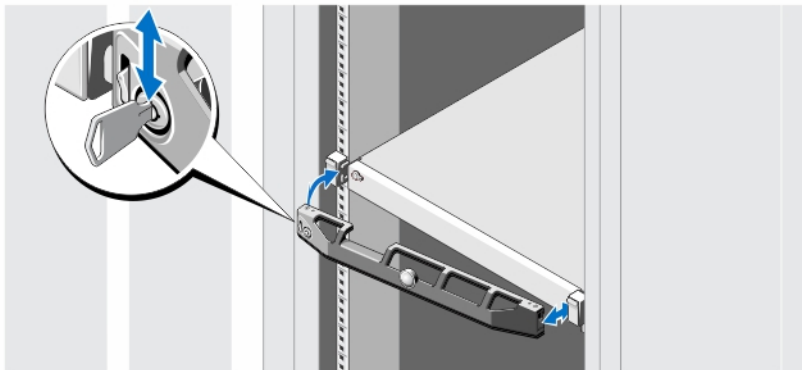



Figure 6. Installing the Optional Bezel

Install the bezel (optional).

Complete The Operating System Setup

If you purchased a preinstalled operating system, see the documentation associated with the operating system. To install an operating system for the first time, see the installation and configuration documentation for your operating system. Be sure the operating system is installed before installing hardware or software not purchased with the system.

 **NOTE:** See dell.com/ossupport for the latest information on supported operating systems.

Dell Software License Agreement

Before using your system, read the Dell Software License Agreement that came with your system. You must consider any media of Dell-installed software as BACKUP copies of the software installed on your system's hard drive. If you do

not accept the terms of the agreement, call the customer assistance telephone number. For customers in the United States, call 800-WWW-DELL (800-999-3355). For customers outside the United States, visit support.dell.com and select your country or region from the bottom of the page.

Other Information You May Need

 **WARNING:** See the safety and regulatory information that shipped with your system. Warranty information may be included within this document or as a separate document.

- The *Owner's Manual* provides information about system features and describes how to troubleshoot the system and install or replace system components. This document is available online at support.dell.com/manuals.
- The rack documentation included with your rack solution describes how to install your system into a rack, if required.
- Any media that ships with your system that provides documentation and tools for configuring and managing your system, including those pertaining to the operating system, system management software, system updates, and system components that you purchased with your system.

 **NOTE:** Always check for updates on support.dell.com/manuals and read the updates first because they often supersede information in other documents.

 **NOTE:** When upgrading your system, it is recommended that you download and install the latest BIOS, driver, and systems management firmware on your system from support.dell.com.

Obtaining Technical Assistance

If you do not understand a procedure in this guide or if the system does not perform as expected, see your *Owner's Manual*. Dell offers comprehensive hardware training and certification. See dell.com/training for more information. This service may not be offered in all locations.

NOM Information (Mexico Only)

The following information is provided on the device described in this document in compliance with the requirements of the official Mexican standards (NOM):



Importer:	Dell Inc. de México, S.A. de C.V. Paseo de la Reforma 2620 -11° Piso Col. Lomas Altas 11950 México, D.F.
Model number:	E18S
Supply voltage:	100 V CA–240 V CA
Frequency:	50 Hz/60 Hz
Current consumption:	7.4 A – 3.7 A (X2) (with 550 W Redundant AC Power Supply Unit) 7.4 A – 3.7 A (with 550 W Non-redundant AC Power Supply Unit) 4.8 A – 2.4 A (X2) (with 350 W Redundant AC Power Supply Unit)

Technical Specifications

 **NOTE:** The following specifications are only those required by law to ship with your system. For a complete and current listing of the specifications for your system, go to support.dell.com.

Power

AC Power Supply (per power supply)

Wattage	350 W and 550 W
Heat dissipation	1356 BTU/hr maximum (redundant, 350 W power supply) 2132 BTU/hr maximum (redundant, 550 W power supply) 2315 BTU/hr maximum (non-redundant, 550 W power supply)
 NOTE: Heat dissipation is calculated using the power supply wattage rating.	
Voltage	100–240 V AC, autoranging, 50/60 Hz
 NOTE: This system is also designed to be connected to IT power systems with a phase to phase voltage not exceeding 230 V.	

Battery

Coin-cell battery	3 V CR2032 Lithium coin cell
-------------------	------------------------------

Physical

Height	42.8 mm (1.68 inch)
Width	
With rack latches	482.4 mm (18.99 inch)
Without rack latches	434.0 mm (17.08 inch)
Depth (excludes bezel)	607.0 mm (23.9 inch)
Weight (maximum)	19.9 kg (43.87 lb)
Weight (empty)	16.73 kg (36.88 lb)

Environmental

 **NOTE:** Your system is capable of 40 °C and 45 °C excursion operation for fresh air cooled data centers. For more information, see the Owner's Manual.

 **NOTE:** For additional information about environmental measurements for specific system configurations, see dell.com/environmental_datasheets.

Temperature

Operating	Continuous operation: 10 °C to 35 °C. De-rate maximum allowable dry bulb temperature at 1 °C/300 m above 900 m (1 °F /550 ft).
-----------	--

Environmental



NOTE: For information on supported expanded operating temperature range and configurations, see support.dell.com/manuals.

Storage

–40 °C to 65 °C (–40 °F to 149 °F) with a maximum temperature gradation of 20 °C per hour.

Relative humidity

Operating

10% to 80% relative humidity (RH), with 26 °C maximum dew point.

Storage

5% to 95% relative humidity ambient with 33 °C (91 °F) maximum dew point.

Maximum vibration

Operating

0.26 Grms at 5 Hz to 350 Hz (all operation orientations).

Storage

1.87 Grms at 10 Hz to 500 Hz for 15 min (all six sides tested).

Maximum shock

Operating

One shock pulse in the positive z axis (one pulse on each side of the system) of 31 G for 2.6 ms in the operational orientation.

Storage

Six consecutively executed shock pulses in the positive and negative x, y, and z axes (one pulse on each side of the system) of 71 G for up to 2 ms.

Six consecutively executed shock pulses in the positive and negative x, y, and z axes (one pulse on each side of the system) of 22 G faired square wave pulse with velocity change at 200 inches/second (508 centimeters/second).

Altitude

Operating

–15.2 m to 3048 m (–50 to 10,000 ft).



NOTE: For altitudes above 2950 ft, the maximum operating temperature is derated 1 °F/550 ft.

Storage

–15.2 m to 10,668 m (–50 ft to 35,000 ft).

Airborne contaminant level

Class

G1 as defined by ISA-S71.04-1985.

Free Manuals Download Website

<http://myh66.com>

<http://usermanuals.us>

<http://www.somanuals.com>

<http://www.4manuals.cc>

<http://www.manual-lib.com>

<http://www.404manual.com>

<http://www.luxmanual.com>

<http://aubethermostatmanual.com>

Golf course search by state

<http://golfingnear.com>

Email search by domain

<http://emailbydomain.com>

Auto manuals search

<http://auto.somanuals.com>

TV manuals search

<http://tv.somanuals.com>