

10" Compound Miter Saw

(Model 36-220)



PART NO. 900327 - 01-01-01
Copyright © 2001 Delta Machinery

 **DELTA**

To learn more about DELTA MACHINERY
visit our website at: www.deltamachinery.com.

For Parts, Service, Warranty or other Assistance,

please call **1-800-223-7278** (In Canada call **1-800-463-3582**).

ESPAÑOL: PÁGINA 23

SAFETY RULES

Woodworking can be dangerous if safe and proper operating procedures are not followed. As with all machinery, there are certain hazards involved with the operation of the product. Using the machine with respect and caution will considerably lessen the possibility of personal injury. However, if normal safety precautions are overlooked or ignored, personal injury to the operator may result. Safety equipment such as guards, push sticks, hold-downs, featherboards, goggles, dust masks and hearing protection can reduce your potential for injury. But even the best guard won't make up for poor judgment, carelessness or inattention. Always use common sense and exercise caution in the workshop. If a procedure feels dangerous, don't try it. Figure out an alternative procedure that feels safer. **REMEMBER:** Your personal safety is your responsibility.

This machine was designed for certain applications only. Delta Machinery strongly recommends that this machine not be modified and/or used for any application other than that for which it was designed. If you have any questions relative to a particular application, **DO NOT** use the machine until you have first contacted Delta to determine if it can or should be performed on the product.

Technical Service Manager
Delta Machinery
4825 Highway 45 North
Jackson, TN 38305

(IN CANADA: 505 SOUTHGATE DRIVE, GUELPH, ONTARIO N1H 6M7)



WARNING: FAILURE TO FOLLOW THESE RULES MAY RESULT IN SERIOUS PERSONAL INJURY

1. FOR YOUR OWN SAFETY, READ INSTRUCTION MANUAL BEFORE OPERATING THE TOOL. Learn the tool's application and limitations as well as the specific hazards peculiar to it.

2. KEEP GUARDS IN PLACE and in working order.

3. ALWAYS WEAR EYE PROTECTION.

4. REMOVE ADJUSTING KEYS AND WRENCHES. Form habit of checking to see that keys and adjusting wrenches are removed from tool before turning it "on".

5. KEEP WORK AREA CLEAN. Cluttered areas and benches invite accidents.

6. DON'T USE IN DANGEROUS ENVIRONMENT. Don't use power tools in damp or wet locations, or expose them to rain. Keep work area well-lighted.

7. KEEP CHILDREN AND VISITORS AWAY. All children and visitors should be kept a safe distance from work area.

8. MAKE WORKSHOP CHILDPROOF – with padlocks, master switches, or by removing starter keys.

9. DON'T FORCE TOOL. It will do the job better and be safer at the rate for which it was designed.

10. USE RIGHT TOOL. Don't force tool or attachment to do a job for which it was not designed.

11. WEAR PROPER APPAREL. No loose clothing, gloves, neckties, rings, bracelets, or other jewelry to get caught in moving parts. Non-slip footwear is recommended. Wear protective hair covering to contain long hair.

12. ALWAYS USE SAFETY GLASSES. Wear safety glasses. Everyday eyeglasses only have impact resistant lenses; they are not safety glasses. Also use face or dust mask if cutting operation is dusty. These safety glasses must conform to ANSI Z87.1 requirements. Note: Approved glasses have Z87 printed or stamped on them.

13. SECURE WORK. Use clamps or a vise to hold work when practical. It's safer than using your hand and frees both hands to operate tool.

14. DON'T OVERREACH. Keep proper footing and balance at all times.

15. MAINTAIN TOOLS IN TOP CONDITION. Keep tools sharp and clean for best and safest performance. Follow instructions for lubricating and changing accessories.

16. DISCONNECT TOOLS before servicing and when changing accessories such as blades, bits, cutters, etc.

17. USE RECOMMENDED ACCESSORIES. The use of accessories and attachments not recommended by Delta may cause hazards or risk of injury to persons.

18. REDUCE THE RISK OF UNINTENTIONAL STARTING. Make sure switch is in "OFF" position before plugging in power cord.

19. NEVER STAND ON TOOL. Serious injury could occur if the tool is tipped or if the cutting tool is accidentally contacted.

20. CHECK DAMAGED PARTS. Before further use of the tool, a guard or other part that is damaged should be carefully checked to ensure that it will operate properly and perform its intended function – check for alignment of moving parts, binding of moving parts, breakage of parts, mounting, and any other conditions that may affect its operation. A guard or other part that is damaged should be properly repaired or replaced.

21. DIRECTION OF FEED. Feed work into a blade or cutter against the direction of rotation of the blade or cutter only.

22. NEVER LEAVE TOOL RUNNING UNATTENDED. TURN POWER OFF. Don't leave tool until it comes to a complete stop.

23. DRUGS, ALCOHOL, MEDICATION. Do not operate tool while under the influence of drugs, alcohol or any medication.

24. MAKE SURE TOOL IS DISCONNECTED FROM POWER SUPPLY while motor is being mounted, connected or re-connected.

25. THE DUST GENERATED by certain woods and wood products can be injurious to your health. Always operate machinery in well ventilated areas and provide for proper dust removal. Use wood dust collection systems whenever possible.

26. ⚠ WARNING: SOME DUST CREATED BY POWER SANDING, SAWING, GRINDING, DRILLING, AND OTHER CONSTRUCTION ACTIVITIES contains chemicals known to cause cancer, birth defects or other reproductive harm. Some examples of these chemicals are:

- lead from lead-based paints,
- crystalline silica from bricks and cement and other masonry products, and
- arsenic and chromium from chemically-treated lumber.

Your risk from these exposures varies, depending on how often you do this type of work. To reduce your exposure to these chemicals: work in a well ventilated area, and work with approved safety equipment, such as those dust masks that are specially designed to filter out microscopic particles.

SAVE THESE INSTRUCTIONS

ADDITIONAL SAFETY RULES FOR COMPOUND MITER SAWS

1. **USE ONLY CROSS-CUTTING SAW BLADES. WHEN USING CARBIDE TIPPED BLADES, MAKE SURE THEY HAVE A NEGATIVE HOOK ANGLE. DO NOT USE BLADES WITH DEEP GULLETS AS THEY CAN DEFLECT AND CONTACT GUARD.**
2. **DO NOT OPERATE** the miter saw until it is completely assembled and installed according to the instructions.
3. **IF YOU ARE NOT** thoroughly familiar with the operation of miter saws, obtain advice from your supervisor, instructor or other qualified person.
4. **ALWAYS** hold the work firmly against the fence and table. **DO NOT** perform any operation freehand.
5. **KEEP HANDS OUT OF PATH** of saw blade. If the workpiece you are cutting would cause your hand to be within hazard zone of the saw blade, the workpiece should be clamped in place before making cut.
6. **BE SURE** blade is sharp, runs freely and is free of vibration.
7. **ALLOW** the motor to come up to full speed before starting cut.
8. **KEEP** motor air slots clean and free of chips.
9. **ALWAYS MAKE SURE** all clamp handles are tight before cutting, even if the table is positioned in one of the positive stops.
10. **BE SURE** blade and flanges are clean and that arbor screw is tightened securely.
11. **USE** only blade flanges specified for your saw.
12. **NEVER** use blades larger or smaller in diameter than recommended.
13. **NEVER** apply lubricants to the blade when it is running.
14. **ALWAYS** check the blade for cracks or damage before operation. Replace cracked or damaged blade immediately.
15. **NEVER** use blades recommended for operation at less than 5500 RPM.
16. **USE** the blade guard at all times.
17. **ALWAYS** keep the lower blade guard in place.
18. **NEVER** reach around saw blade.
19. **MAKE SURE** blade is not contacting workpiece before switch is turned on.
20. **NEVER** lock the switch in the "ON" position.
21. **IMPORTANT:** After completing cut, release power switch and wait for coasting blade to stop before returning saw to raised position.
22. **MAKE SURE** blade has come to a complete stop before removing or securing workpiece, changing workpiece angle or changing the angle of the blade.
23. **NEVER** cut ferrous metals or masonry.
24. **NEVER** recut small pieces.
25. **PROVIDE** adequate support to the sides of the saw table for long workpieces.
26. **NEVER** use the miter saw in an area with flammable liquids or gases.
27. **NEVER** use solvents to clean plastic parts. Solvents could possibly dissolve or otherwise damage the material. Only a soft damp cloth should be used to clean plastic parts.
28. **SHUT OFF** power before servicing or adjusting tool.
29. **DISCONNECT** saw from power source and clean the machine before leaving it.
30. **MAKE SURE** the work area is cleaned before leaving the machine.
31. **SHOULD** any part of your miter saw be missing, damaged or fail in any way, or any electrical component fail to perform properly, shut off switch and remove plug from power supply outlet. Replace missing, damaged or failed parts before resuming operation.
32. **ADDITIONAL INFORMATION** regarding the safe and proper operation of this product is available from the National Safety Council, 1121 Spring Lake Drive, Itasca, IL 60143-3201, in the Accident Prevention Manual for Industrial Operation and also in the Safety Data Sheets provided by the NSC. Please also refer to the American National Standard Institute ANSI O1.1 Safety Requirements for Woodworking Machinery and the U.S. Department of Labor OSHA 1910.213 Regulations.

CONNECTING COMPOUND MITER SAW TO POWER SOURCE

Your new Compound Miter Saw is **DOUBLE INSULATED** to give you added safety. As a result, this saw is equipped with a two-prong plug which permits you to use any conventional 120 Volt electrical outlet without concern for maintaining a ground connection.

Before connecting the motor to the power source make sure that the electric current is of the same characteristics as the motor - 120 Volts. All line connections should make good contact. Running on low voltage will damage the motor.

CAUTION: WHEN SERVICING DOUBLE INSULATED TOOLS, USE ONLY IDENTICAL REPLACEMENT PARTS. REPLACE OR REPAIR DAMAGED CORDS IMMEDIATELY.

MOTOR SPECIFICATIONS

Your miter saw is wired for 110-120 volt, 60 HZ alternating current. Before connecting the miter saw to the power source, make sure the switch is in the "OFF" position. The motor provides a no-load speed of 5200 RPM.

REPLACEMENT PARTS

When servicing, use only identical replacement parts.

POLARIZED PLUGS: To reduce the risk of electric shock, this equipment has a polarized plug (one blade is wider than the other). This plug will fit in a polarized outlet only one way. If the plug does not fit fully in the outlet, reverse the plug. If it still does not fit, contact a qualified electrician to install the proper outlet. Do not change the plug in any way.

EXTENSION CORDS

Use proper extension cords. Make sure your extension cord is in good condition and be sure to use one heavy enough to carry the current of the saw. An undersized cord will cause a drop in line voltage resulting in loss of power and overheating. Fig. D, shows the correct size to use depending on cord length. If in doubt, use the next heavier gage. The smaller the gage number, the heavier the cord.

MINIMUM GAUGE EXTENSION CORD			
RECOMMENDED SIZES FOR USE WITH STATIONARY ELECTRIC TOOLS			
Ampere Rating	Volts	Total Length of Cord in Feet	Gauge of Extension Cord
0-6	120	up to 25	18 AWG
0-6	120	25-50	16 AWG
0-6	120	50-100	16 AWG
0-6	120	100-150	14 AWG
6-10	120	up to 25	18 AWG
6-10	120	25-50	16 AWG
6-10	120	50-100	14 AWG
6-10	120	100-150	12 AWG
10-12	120	up to 25	16 AWG
10-12	120	25-50	16 AWG
10-12	120	50-100	14 AWG
10-12	120	100-150	12 AWG
12-16	120	up to 25	14 AWG
12-16	120	25-50	12 AWG
12-16	120	GREATER THAN 50 FEET NOT RECOMMENDED	

MINIMUM GAUGE EXTENSION CORD			
RECOMMENDED SIZES FOR USE WITH STATIONARY ELECTRIC TOOLS			
Ampere Rating	Volts	Total Length of Cord in Feet	Gauge of Extension Cord
0-6	240	up to 50	18 AWG
0-6	240	50-100	16 AWG
0-6	240	100-200	16 AWG
0-6	240	200-300	14 AWG
6-10	240	up to 50	18 AWG
6-10	240	50-100	16 AWG
6-10	240	100-200	14 AWG
6-10	240	200-300	12 AWG
10-12	240	up to 50	16 AWG
10-12	240	50-100	16 AWG
10-12	240	100-200	14 AWG
10-12	240	200-300	12 AWG
12-16	240	up to 50	14 AWG
12-16	240	50-100	12 AWG
12-16	240	GREATER THAN 100 FEET NOT RECOMMENDED	

Fig. D

OPERATING INSTRUCTIONS

FOREWORD

Delta Model 36-220 is a 10" Compound Miter Saw designed to cut wood. It can crosscut up to 2-³/₄" x 5-¹/₈", miter at 45° both left and right 2-³/₄" x 3-¹/₂", bevel at 45° left 1-³/₄" x 5-¹/₈", and compound 45° x 45°, 1-³/₄" x 3-¹/₂". It has miter stops at 0°, 15°, 22.5°, 30°, and 45° degrees both left and right, and positive bevel stops at 0° and 45° left. It also includes the following features; Double Insulated construction for operator safety, D-handle design with trigger switch for positive control, lock-out button to prevent accidental starts, Electric brake automatically stops blade in seconds, Automatic retracting see-thru blade guard, Built-in arbor lock for easy single wrench blade changes, Dust bag, Work supports, Extra-wide fence and Replaceable cut-thru table insert for optimum chipbreaking.

UNPACKING

Remove the miter saw and all loose items from the carton. **IMPORTANT: DO NOT LIFT THE MITER SAW BY THE SWITCH HANDLE OR TABLE CONTROL HANDLE AS THIS MAY CAUSE MISALIGNMENT. ALWAYS LIFT THE MACHINE BY THE BASE.**



Fig. 1

⚠ WARNING: FOR YOUR OWN SAFETY, DO NOT CONNECT THE MITER SAW TO THE POWER SOURCE UNTIL THE MACHINE IS COMPLETELY ASSEMBLED AND YOU HAVE READ AND UNDERSTOOD THE ENTIRE OWNER'S MANUAL.

ASSEMBLY INSTRUCTIONS

⚠ WARNING: MAKE CERTAIN THE POWER CORD IS DISCONNECTED FROM THE POWER SOURCE DURING THE COMPLETE ASSEMBLY PROCEDURE.

ASSEMBLING LOWER BLADE GUARD LINK

⚠ WARNING: DO NOT ATTEMPT TO OPERATE THE SAW WITHOUT THE BLADE GUARD IN PLACE, AS PERSONAL INJURY OR PRODUCT DAMAGE CAN OCCUR. THE BLADE GUARD ASSEMBLY SERVES AS A RETENTION MEANS FOR THE SAW ARBOR. ANY PRODUCT ADJUSTMENTS OR SERVICING, NOT COVERED BY THIS INSTRUCTION MANUAL, SHOULD BE UNDERTAKEN ONLY BY AN AUTHORIZED DELTA SERVICE REPRESENTATIVE.

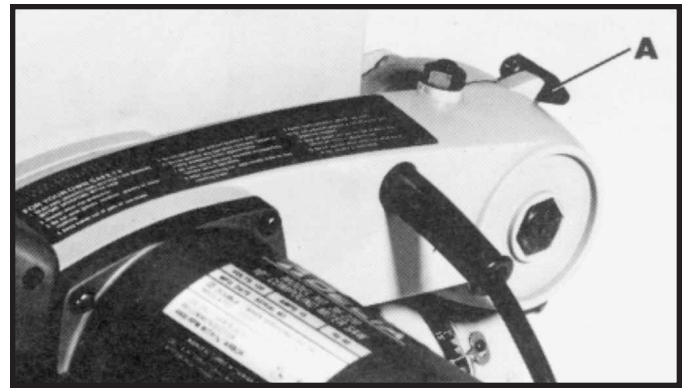

Fig. 2

1. Push down on the cuttinghead handle slightly and rotate latch (A) Fig. 2, to the other side.

2. The cuttinghead will then move to the up position and the lower blade guard link (B) Fig. 3, will hang freely in the down position, as shown.

3. Remove special screw (C) Fig. 3, from the pivot bracket.

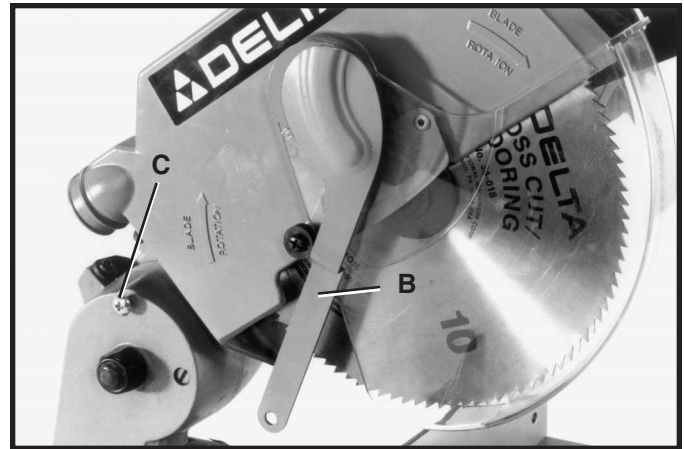

Fig. 3

4. Insert special screw (C) Fig. 4, into hole in end of lower blade guard link (B) and reassemble special screw (C) into hole in pivot bracket, as shown.

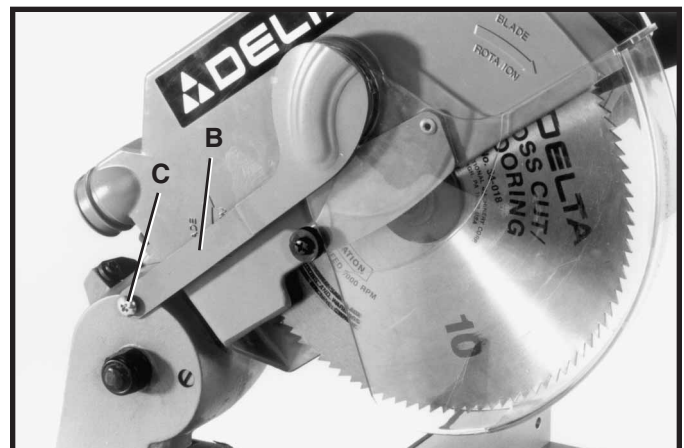

Fig. 4

ASSEMBLING STOCK STOP AND TABLE EXTENSIONS

1. Decide on which side of the saw table you want the stock stop (A) Fig. 5, to be, and assemble stock stop (A) onto table extension (B), as shown. **NOTE:** The most commonly used position of the stock stop will be on the right hand table extension, as shown.

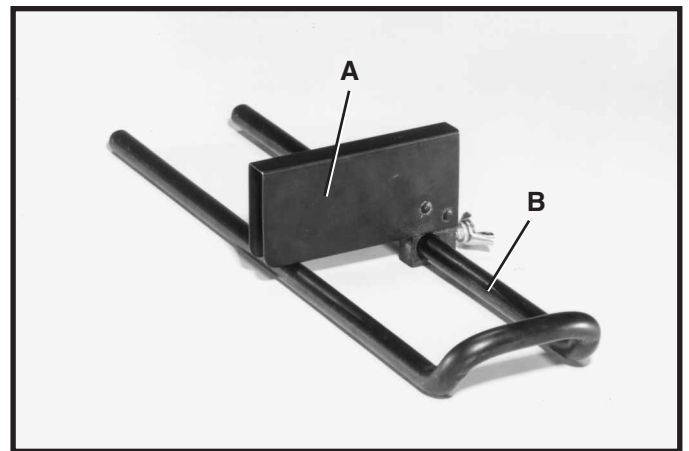

Fig. 5

2. Insert ends of table extension (B) Fig. 6, into the four holes on end of saw base and into the two holes of lock bracket (C), as shown. Tighten screw (D) to hold table extension in place.

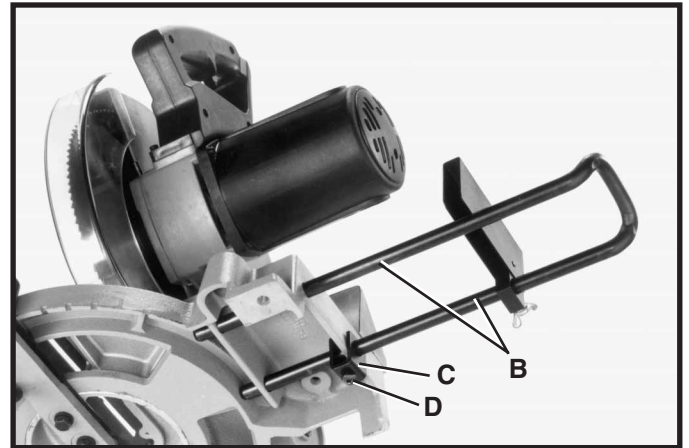

Fig. 6

3. Assemble left hand table extension (E) Fig. 7, in the same manner.

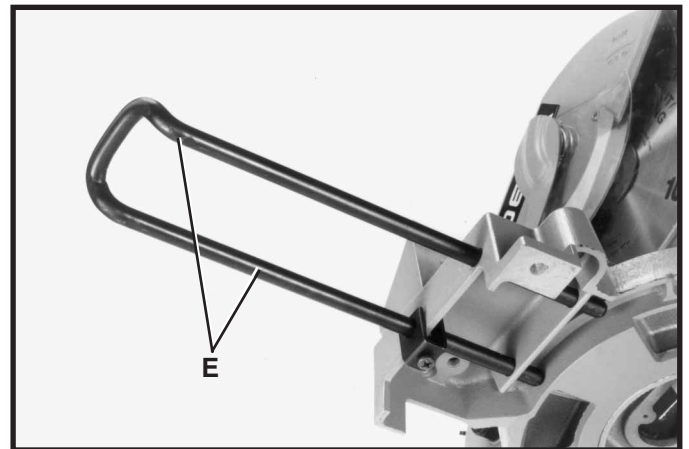

Fig. 7

4. Fig. 8, illustrates both the right and left hand table extensions (B) and (E) assembled to the saw and the stock stop (A) assembled to the right hand table extension.

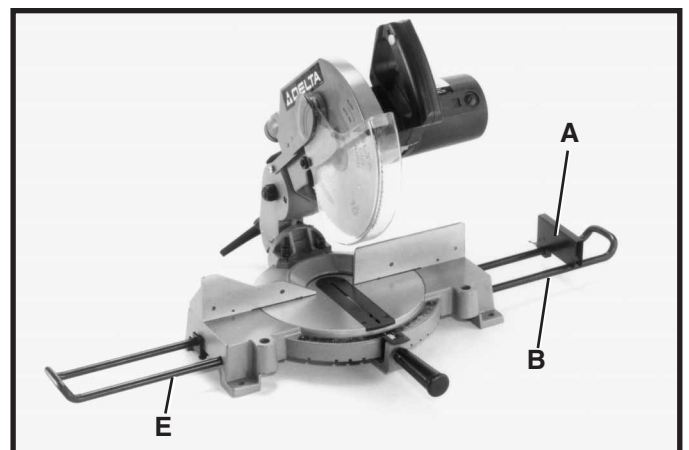

Fig. 8

ASSEMBLING ACCESSORY WORK CLAMP TO SAW

1. The work clamp (A) Fig. 9, can be used on either the right or left side of the saw base. Insert post of work clamp into the hole located on the front of the saw base, as shown. Work clamp 36-221 is available as a accessory. (See ASSESSORIES section)

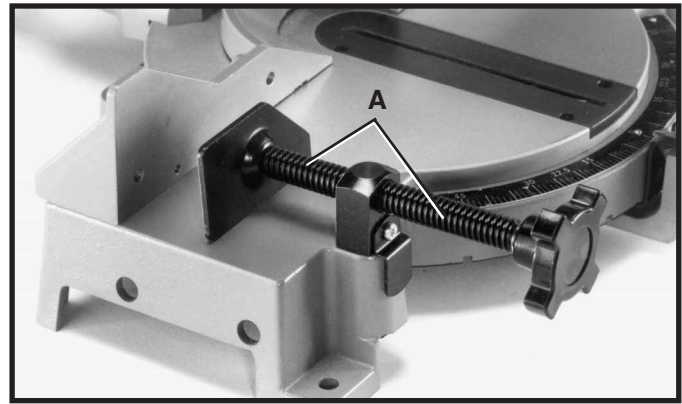

Fig. 9

2. **IMPORTANT:** The purpose of the work clamp (A) Fig. 10, is to clamp material against the fence. When the work clamp (A) is used in conjunction with the stock stop (B), the work clamp (A) and stock stop (B) should **ALWAYS** be used on the same side of the saw blade. This is important as it prevents the free end of the workpiece from binding between the blade and the stock stop (B).

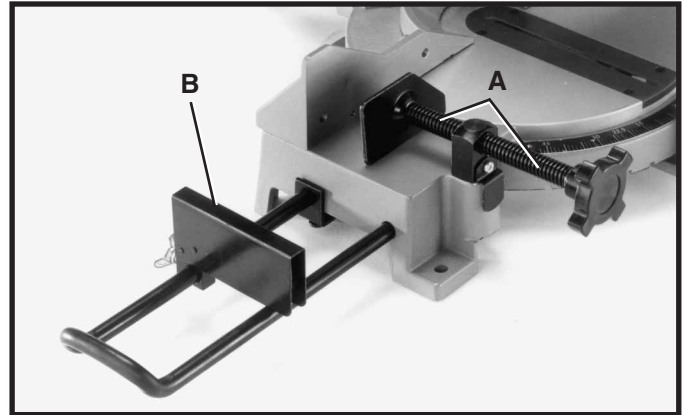



Fig. 10

3.  **WARNING:** Keep hands out of path of saw blade. If the workpiece you are cutting would cause your hand to be within 4 inches of the saw blade, the workpiece should be clamped in place before making cut.

ASSEMBLING DUST BAG

1. Assemble the dust bag (A) Fig. 11, to dust spout on rear of guard assembly, as shown.

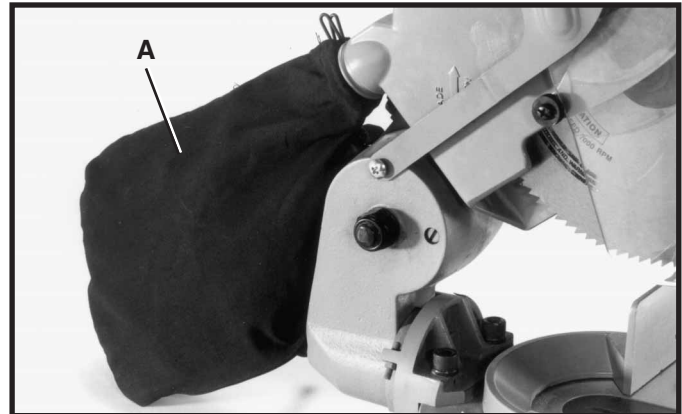

Fig. 11

FASTENING COMPOUND MITER SAW TO SUPPORTING SURFACE

Before operating your compound miter saw make sure it is firmly mounted to a workbench or other supporting surface. Four holes are provided, three of which are shown at (A) Fig. 12, for fastening the saw to a supporting surface.

When frequently moving the saw from place to place we suggest that the saw be mounted to a 3/4" piece of plywood. The saw can then be easily moved and the plywood clamped to the supporting surface using "C" clamps.

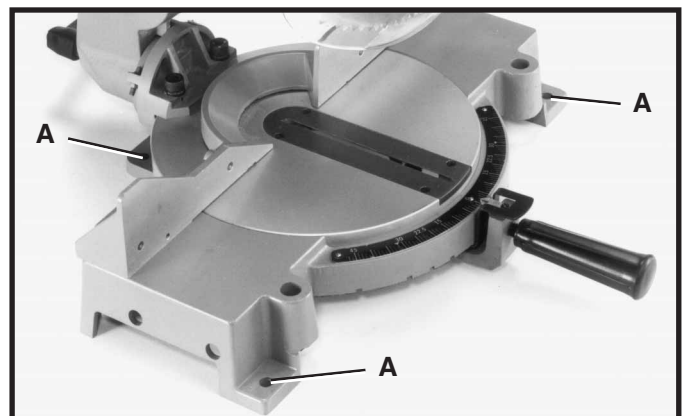

Fig. 12

OPERATING CONTROLS

TABLE HAZARD AREA

⚠ WARNING: THE AREA INSIDE THE TWO RED LINES (A) FIG. BB, ON THE TABLE IS DESIGNATED AS A HAZARD ZONE. NEVER PLACE YOUR HANDS INSIDE THIS AREA WHILE THE TOOL IS BEING OPERATED.

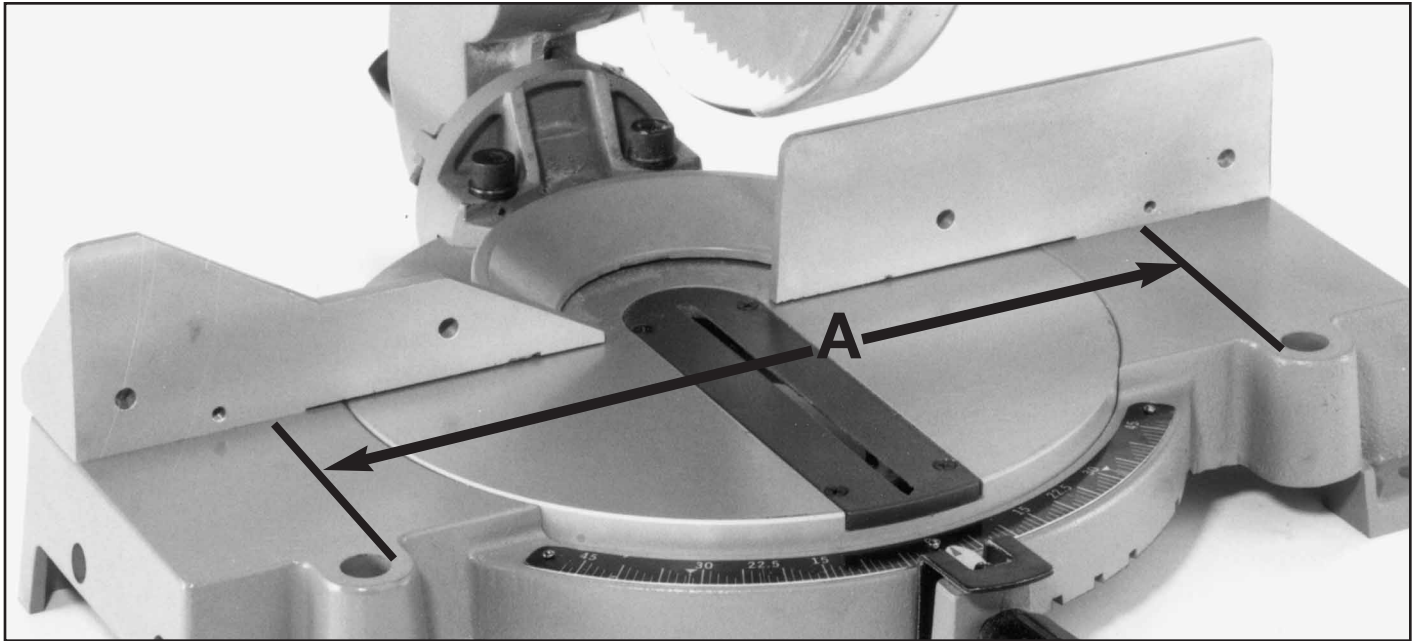

Fig. BB

STARTING AND STOPPING SAW

To turn the saw “ON” push in on switch lock key (A) Fig. 13, and depress switch trigger (B). To turn the saw “OFF” release switch trigger (B).

Your compound miter saw is equipped with an automatic electric blade brake. As soon as the switch trigger (B) Fig. 13, is released, the electric brake is activated and stops the blade in seconds.

⚠ WARNING: A TURNING SAW BLADE CAN BE DANGEROUS. AFTER COMPLETING CUT, RELEASE SWITCH TRIGGER TO ACTIVATE BLADE BRAKE. KEEP SAW HEAD DOWN UNTIL BLADE HAS COME TO A COMPLETE STOP.

⚠ WARNING: THE TORQUE DEVELOPED DURING BRAKING MAY LOOSEN THE ARBOR SCREW. THE ARBOR SCREW SHOULD BE CHECKED PERIODICALLY AND TIGHTENED IF NECESSARY.

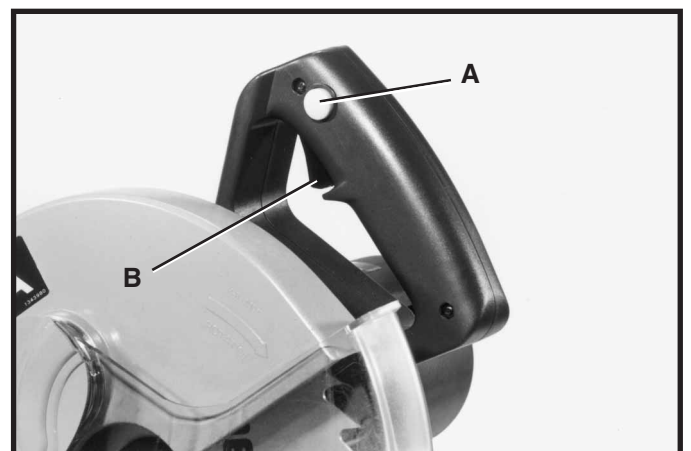

Fig. 13

ROTATING TABLE FOR MITER CUTTING

Your compound miter saw will cut any miter angle from a straight 90 degree cut-off to 47 degrees right and left. Simply loosen lock handle (A) Fig. 14, depress index lever (B) and move the control arm to the desired angle. Then tighten lock handle (A).

The 10" Compound Miter Saw is equipped with positive miter stops for the table control arm at the 0, 15, 22-1/2, 30 and 45 degree right and left positions. Simply loosen lock handle (A) Fig. 14, and move the control arm until the spring loaded index lever (B) engages into one of the positive stops (four of which are shown at (C)). Then tighten lock handle (A). To disengage the positive stop, depress index lever (B). **IMPORTANT: ALWAYS TIGHTEN LOCK HANDLE (A) BEFORE CUTTING.**

In addition, two triangle indicators (D) Fig. 15, are provided on the scale at the 31-5/8 degree right and left miter angle for cutting crown moulding. Refer to the **CUTTING CROWN MOULDING** section of this manual.

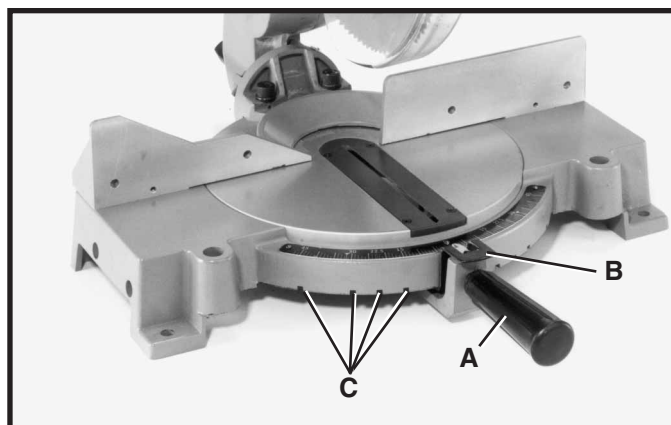

Fig. 14

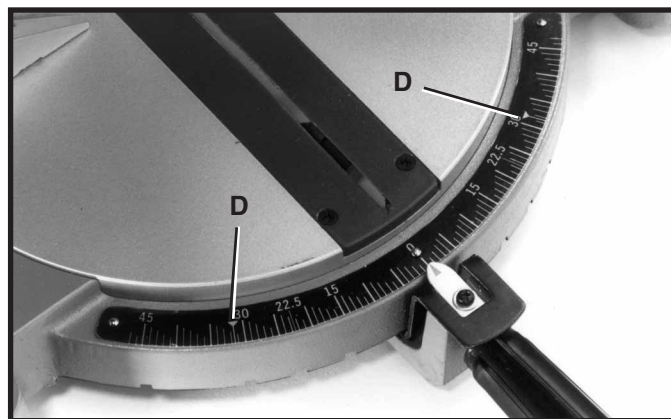

Fig. 15

TILTING CUTTING ARM FOR BEVEL CUTTING

The cutting arm of your compound miter saw can be tilted to cut any bevel angle from a 90 degree straight cut-off to a 45 degree left bevel angle by loosening bevel lock handle (A) Fig. 16, tilting cutting arm to the desired angle and tightening lock handle (A). **NOTE:** Lock handle (A) is spring loaded and can be repositioned by pulling out on the handle and repositioning it on the nut located underneath the hub of the handle.

Positive stops are provided to rapidly position the saw blade at 90 and 45 degrees to the table. The bevel angle of the cutting arm is determined by the position of the pointer (B) Fig. 16, on the scale (C).

In addition, a triangle indicator (D) Fig. 17, is provided on the scale at the 33-7/8 degree bevel angle for cutting crown moulding. Refer to the **CUTTING CROWN MOULDING** section of this manual.

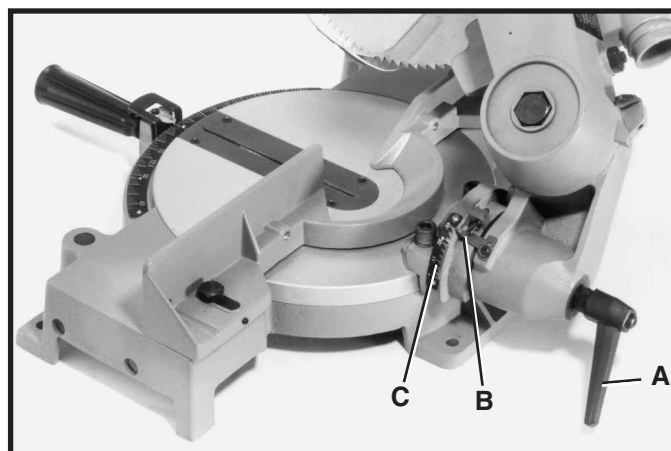

Fig. 16

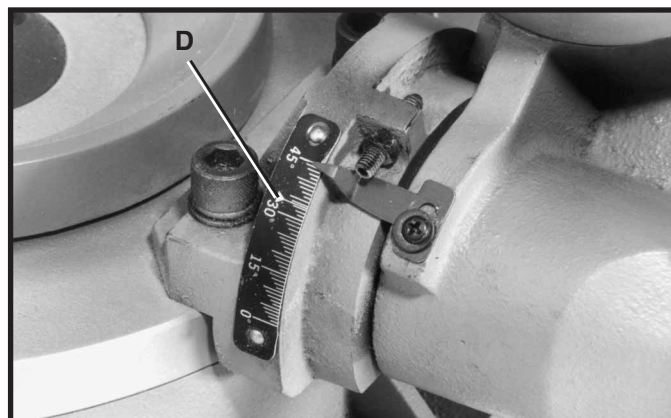

Fig. 17

LOCKING CUTTING ARM IN THE DOWN POSITION

When transporting the saw, the cutting arm should always be locked in the down position. This can be accomplished by lowering the cutting arm (A) Fig. 18, and moving the locking lever (B) to the locked position, as shown. **IMPORTANT: NEVER CARRY THE COMPOUND MITER SAW BY THE SWITCH HANDLE, CUTTING ARM OR TABLE CONTROL HANDLE. THIS MAY CAUSE MISALIGNMENT. ALWAYS LIFT THE MACHINE BY THE BASE.**

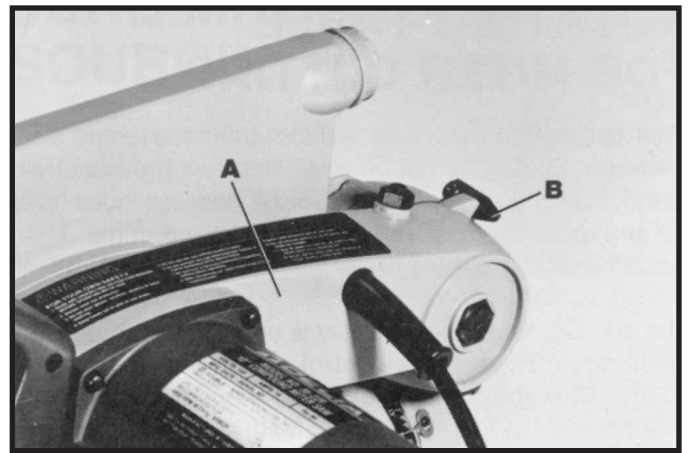

Fig. 18

TWO POSITION FENCE

The fence (A) on your miter saw can be used in the forward position, as shown in Fig. 19, or in the rear position, as shown in Fig. 20. The forward position, in Fig. 19, is used for cutting workpieces up to a standard 4 x 4 and is the most common fence position.

The rear fence position, shown in Fig. 20, is used when cutting off or beveling standard 2 x 6 workpieces.

To change the fence position (from forward to rear or rear to forward position) loosen the two fence locking screws, one of which is shown at (B) Figs. 19 and 20, position the fence (A) in either the forward or rear position and tighten the two fence locking screws (B).

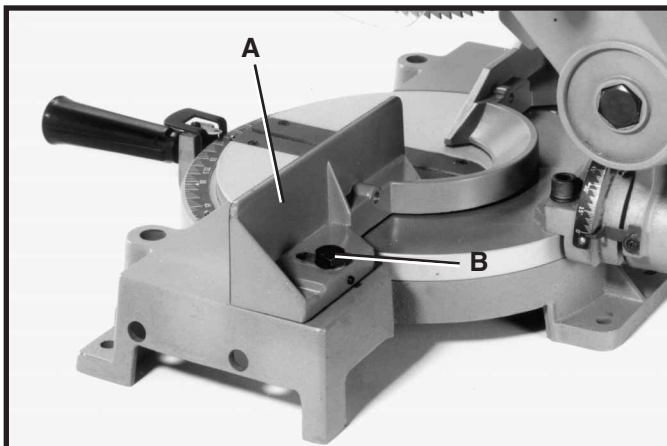

Fig. 19

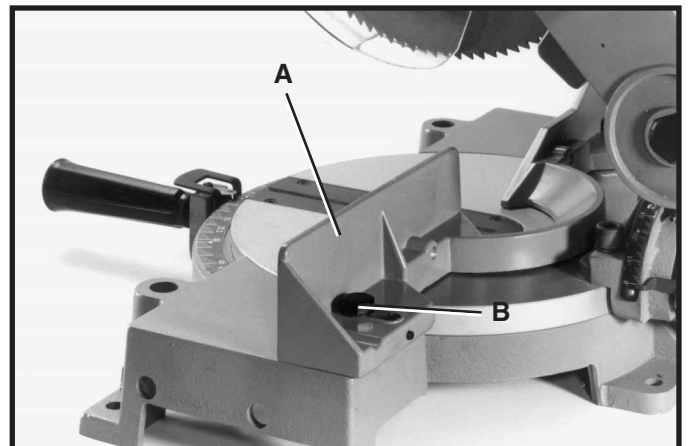

Fig. 20

ADJUSTMENTS

ADJUSTING 90 AND 45 DEGREE BEVEL STOPS

1. DISCONNECT THE SAW FROM THE POWER SOURCE.

2. Loosen bevel lock handle and tilt the cutting arm all the way to the right and tighten the bevel lock handle.

3. Using a square (A) Fig. 21, place one end of the square on the table and the other end against the blade. Check to see if the blade is at 90 degrees to the table, as shown in Fig. 21.

4. If an adjustment is necessary, loosen locknut (B) Fig. 22, and turn screw (C) until other end of screw (C) contacts casting (D) when blade is 90 degrees to the table. Then tighten locknut (B).

5. Loosen bevel lock handle and tilt the cutting arm all the way to the left bevel position and tighten bevel lock handle.

6. Using a combination square (A) Fig. 23, check to see if the blade is at 45 degrees to the table, as shown.

7. If an adjustment is necessary, loosen locknut (E) Fig. 24, and turn screw (F) until other end of screw (F) contacts casting (G) when blade is 45 degrees to the table. Then tighten locknut (E).

8. These positive stops enable you to rapidly position the blade at 90 and 45 degrees to the table.

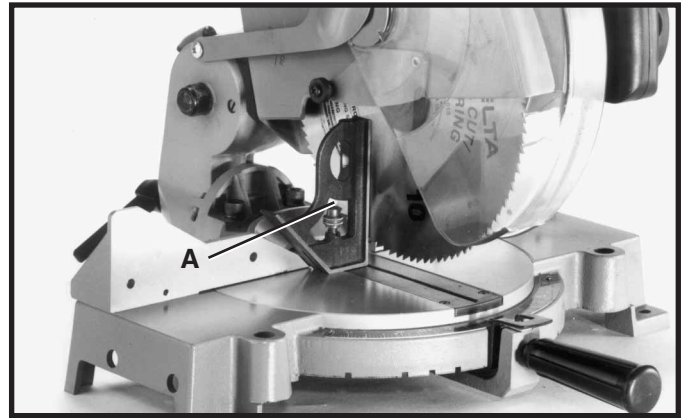

Fig. 21

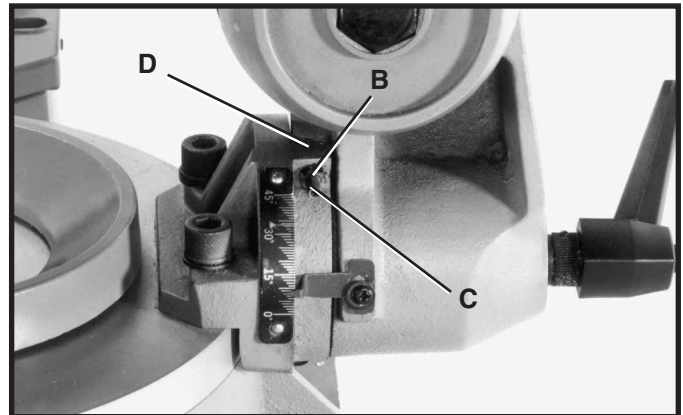

Fig. 22

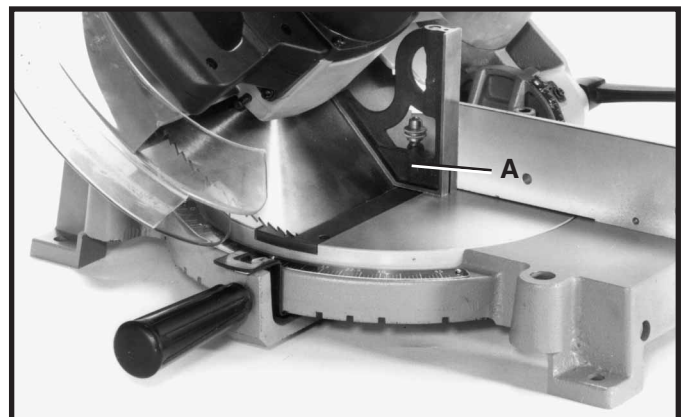

Fig. 23

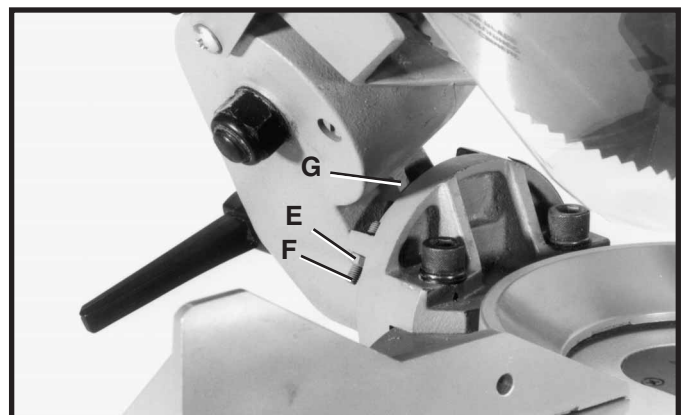

Fig. 24

ADJUSTING BLADE PARALLEL TO TABLE SLOT

1. **DISCONNECT THE SAW FROM THE POWER SOURCE.**
2. **NOTE:** This adjustment should be checked with the cutting arm moved all the way to the right (blade 90 degrees to the table).
3. Lower the cutting arm. The saw blade (A) Fig. 25, should be parallel to the left edge (B) of the table insert opening.
4. If an adjustment is necessary, loosen two screws (C) Fig. 25, and move the cutting arm until the blade is parallel with the left edge (B) of the table insert opening. Then tighten two screws (C).

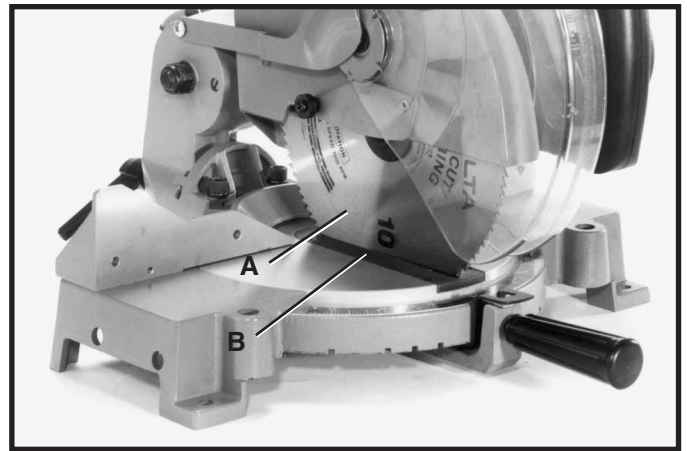

Fig. 25

ADJUSTING FENCE 90 DEGREES TO BLADE

1. **DISCONNECT THE SAW FROM THE POWER SOURCE.**
2. **NOTE:** This adjustment must be made with the fence in both the forward and rear position.
3. Loosen the two fence locking screws, one of which is shown at (A) Fig. 26, and move the fence (B) all the way to the forward position, as shown. Then tighten the two fence locking screws (A).
4. Lower the saw blade and lock the cutting arm in the down position.
5. Using a square (C) Fig. 27, place one end of the square against the blade and the other end against the table, as shown. Check to see if the fence is 90 degrees to the blade.
6. If an adjustment is necessary, loosen the two fence locking screws (A) Fig. 26, and turn the two adjusting screws, one of which is shown at (D) Fig. 26, until you are sure fence is at 90 degrees to the blade when the fence is all the way forward and tighten the two fence locking screws (A) Fig. 26.

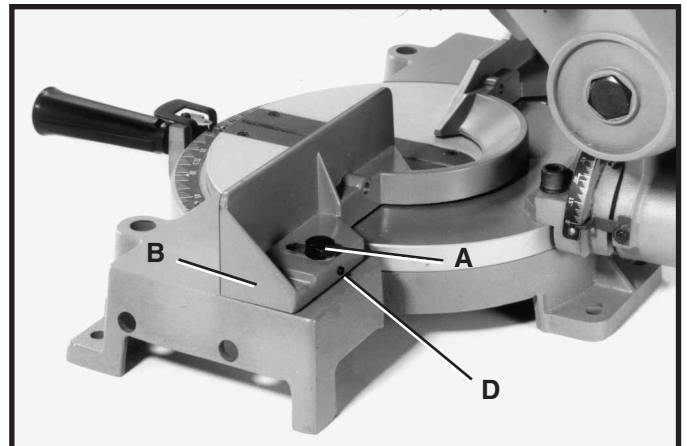

Fig. 26

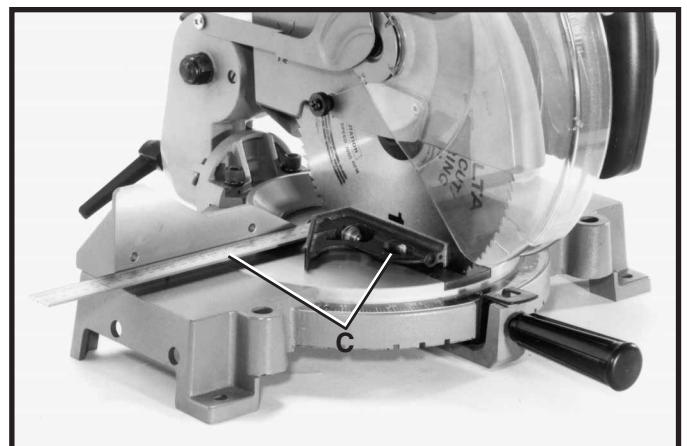

Fig. 27

7. Loosen the two fence locking screws, one of which is shown at (A) Fig. 28, and move the fence (B) all the way to the rear position, as shown. Then tighten the two fence locking screws (A).

8. Using a square, place one end of the square against the blade and the other end against the table and check to see if the fence is 90 degrees to the blade.

9. If an adjustment is necessary, loosen the two fence locking screws (A) Fig. 28, and turn the two adjusting screws, one of which is shown at (E) Fig. 29, until you are sure fence is at 90 degrees to the blade when the fence is all the way to the rear. Then tighten the two fence locking screws (A) Fig. 28.

10. These adjustments enable you to rapidly position the fence in either the forward or rear position making sure that the fence will be 90 degrees to the blade.

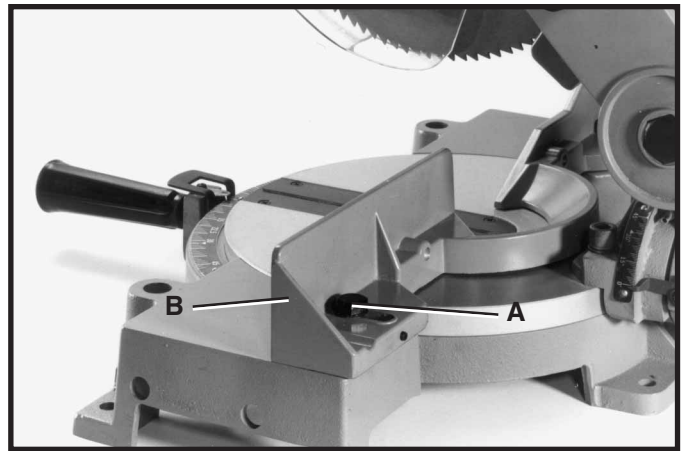

Fig. 28

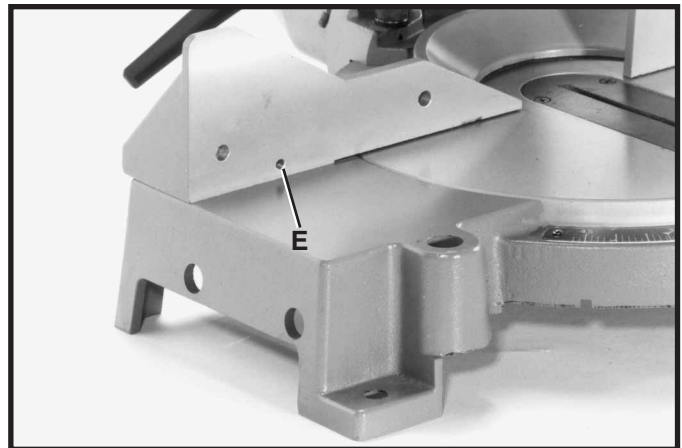

Fig. 29

ADJUSTING SLIDING FIT OF CUTTING ARM VERTICAL TRAVEL

1. **DISCONNECT THE SAW FROM THE POWER SOURCE.**

2. To adjust the sliding fit between the arm (A) Fig. 30, and bracket (B), tighten or loosen the adjusting nut (C). Correct adjustment is when a good snug sliding fit is obtained without any side movement between the arm (A) Fig. 30, and bracket (B). This adjustment should not be too tight that it restricts the sliding movement or too loose that it affects the accuracy of the saw cut.

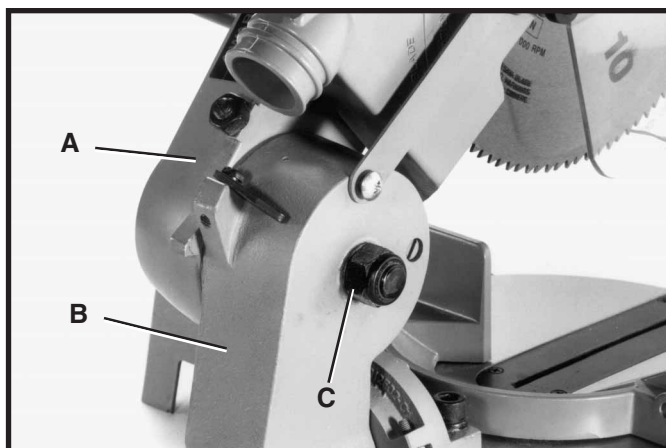

Fig. 30

ADJUSTING DOWNWARD TRAVEL OF SAW BLADE

1. DISCONNECT THE SAW FROM THE POWER SOURCE.

2. The downward travel of the saw blade can be limited to prevent the saw blade from contacting any metal surfaces of the machine. This adjustment is made by loosening locknut (A) Fig. 31, and turning adjusting screw (B) in or out.

3. When making this adjustment, make sure the machine is disconnected from the power source and lower the blade as far as possible. Rotate the blade by hand to make certain the teeth do not contact any metal surfaces.

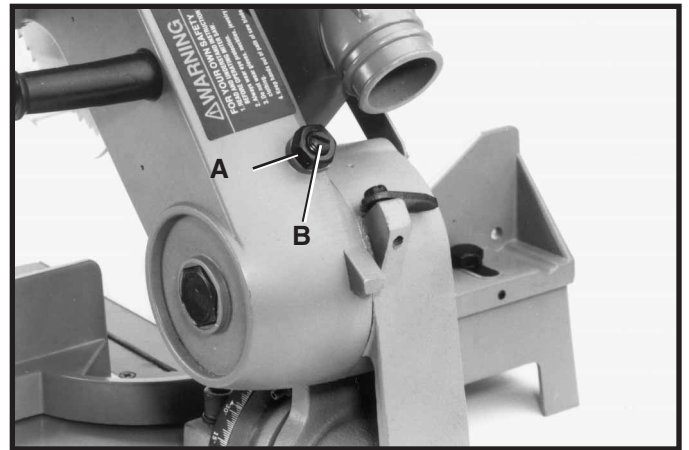

Fig.31

TYPICAL OPERATIONS AND HELPFUL HINTS

1. Before cutting, make certain the miter and bevel angles are set and firmly locked in place.
2. Before cutting, determine that the workpiece is the right size for the saw.
3. Place the workpiece on the table and hold it firmly against the fence.
4. For best results cut at a slow, even cutting rate.
5. If the workpiece you are cutting causes your hand to be within 4 inches of the saw blade the workpiece must be clamped to the fence before cutting.
6. Never attempt any freehand cutting (wood that is not held firmly against the fence and table).

7. Fig. 32, illustrates the fence in the rear position enabling you to cross-cut a standard 2 x 6 in one pass.

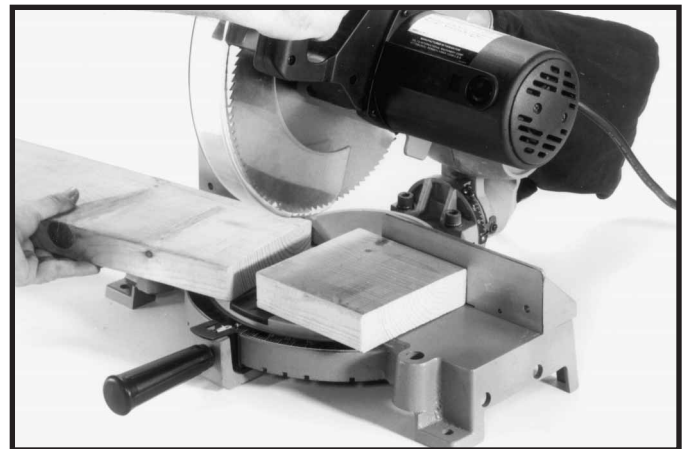

Fig. 32

8. Fig. 33, illustrates the stock stop (A) being used for repetitive cutting operations.

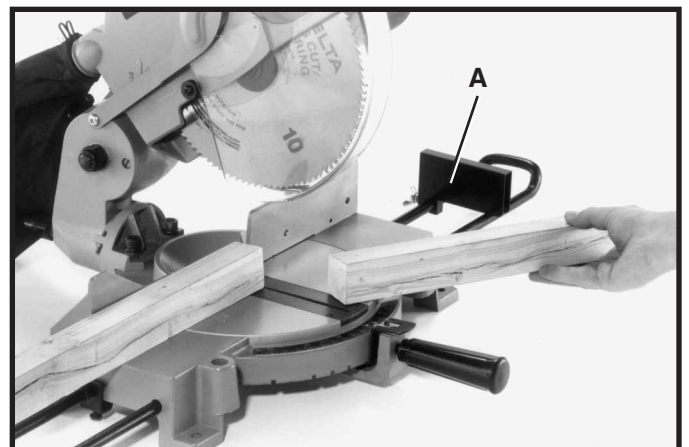

Fig. 33

9. Fig. 34, illustrates the work clamp (B) being used to firmly hold the workpiece against the fence.

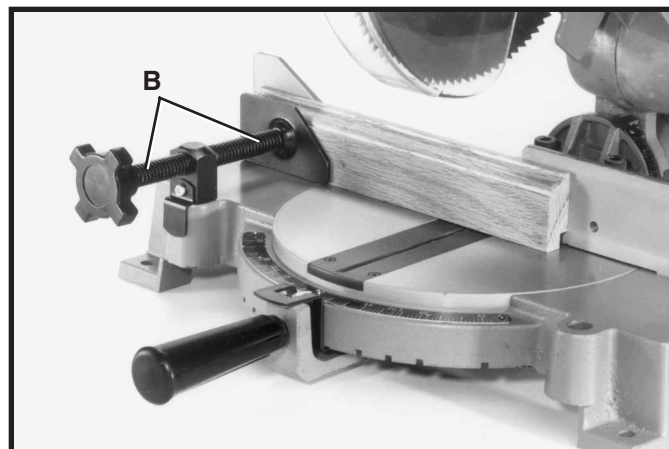

Fig. 34

10. Fig. 35, illustrates the cuttinghead tilted and the arm in a miter position for a compound miter/bevel cutting operation.

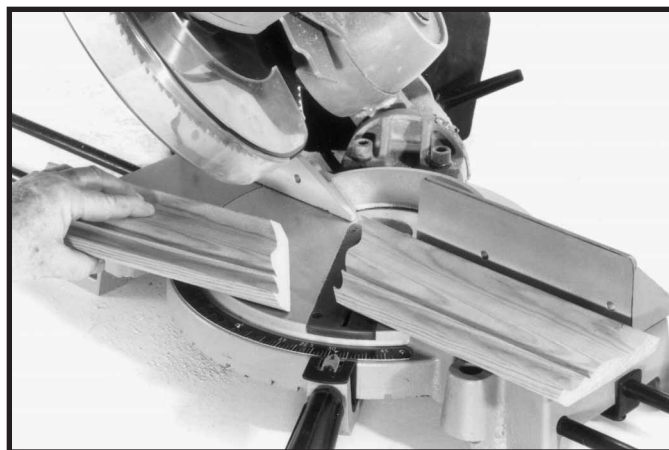

Fig. 35

11. Fig. 36, illustrates the fence in the forward position enabling you to cross-cut a standard 4 x 4 in one pass.

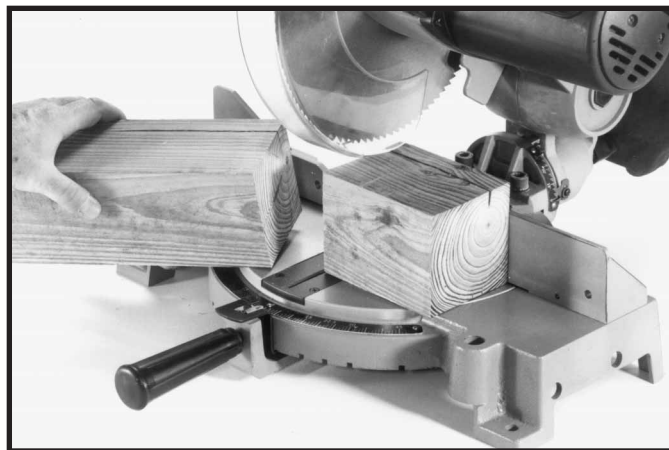

Fig. 36

CUTTING CROWN MOULDING

One of the many features of your saw is the ease of cutting crown moulding. The following is an example of cutting both inside and outside corners on 52/38 degree wall angle crown moulding. **NOTE:** When cutting 45 degree wall angle crown moulding the following procedure for inside and outside corners is the same with the exception that the bevel position will always be at 30 degrees and the miter position will be 34-1/4 degrees to the right or left.

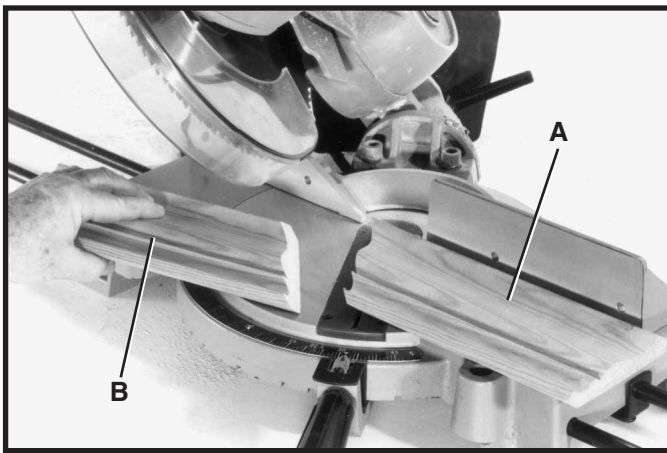

Fig. 37

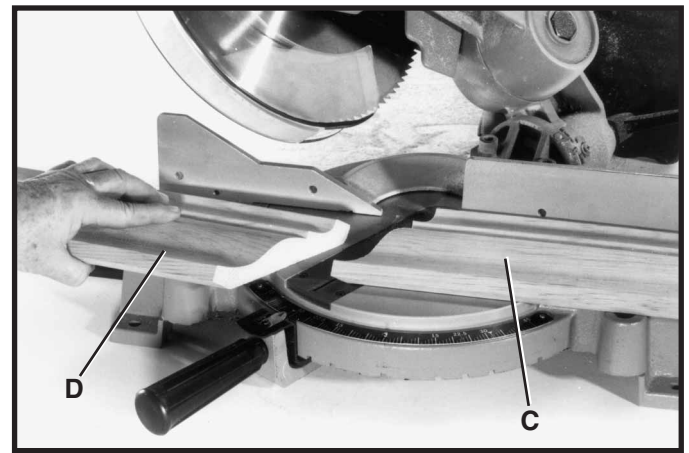

Fig. 38

1. Move the table to the 31-5/8 degree right miter position and lock the table in position. **NOTE:** A triangle indicator is provided on the miter scale to find this angle quickly.
2. Tilt the saw blade to the 33-7/8 degree left bevel position and tighten bevel lock handle. **NOTE:** A triangle indicator is provided on the bevel scale to find this angle quickly.
3. Place the crown moulding on the table with the **CEILING EDGE** of the moulding against the fence, and make the cut, as shown in Fig. 37. **NOTE:** The piece of crown moulding used for the outside corner will always be on the right hand side of the blade, as shown at (A) Fig. 37. The piece of crown moulding used for the inside corner will always be on the left hand side of the blade, as shown at (B) Fig. 37.
4. To make the matching halves of the inside and outside corners simply rotate the table to the 31-5/8 degree left miter position and tighten table lock knob. **NOTE:** A triangle indicator is provided on the miter scale to find this angle quickly.
5. Place the crown moulding on the table with the **WALL EDGE** of the crown moulding against the fence and make the cut. Again, the piece of crown moulding used for the outside corner will always be on the right side of the blade, as shown at (C) Fig. 38. The piece of crown moulding used for the inside corner will always be on the left side of the blade, as shown at (D) Fig. 38.

AUXILIARY WOOD FENCE

When performing multiple or repetitive cut-off operations that result in small cut-off pieces, one inch or less, it is possible for the saw blade to catch the cut-off pieces and project them out of the machine or into the blade guard and housing, possibly causing damage or injury. In order to limit the possibility of personal injury or blade guard damage, an auxiliary wood fence can be mounted to your saw as follows:

Holes are provided in the fence to attach an auxiliary fence (A) Fig. 39. This auxiliary fence is constructed of straight wood approximately 1/2 inch thick by 3 inches high by 20 inches long. **NOTE:** The auxiliary fence (A) is used **ONLY** with the saw blade in the 0 degree bevel position (90 degrees to the table). When bevel cutting (blade tilted) the auxiliary fence will have to be removed.

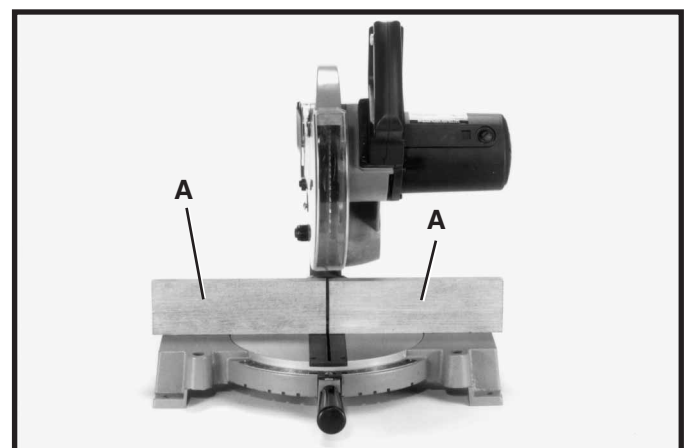

Fig. 39

MAINTENANCE

CHANGING THE BLADE

⚠ WARNING: USE ONLY CROSS-CUTTING SAW BLADES. WHEN USING CARBIDE TIPPED BLADES, MAKE SURE THEY HAVE A NEGATIVE HOOK ANGLE. DO NOT USE BLADES WITH DEEP GULLETS AS THEY CAN DEFLECT AND CONTACT GUARD.

1. **DISCONNECT THE SAW FROM THE POWER SOURCE.**

2. Rotate lower blade guard (A) Fig. 40, to the top position as shown.

3. Loosen screw (B) Fig. 41, to free plate (C).

4. Rotate plate (C) Fig. 42, to the up position as shown.

5. Remove arbor screw (D) Fig. 42, by turning screw (D) clockwise and at the same time pressing in on arbor lock (E) Fig. 43, to keep arbor from turning. Remove screw (D) Fig. 42, arbor washer (F), outside blade flange (G), and blade (H). Note the position of arbor washer (F) and outside blade flange (G) as they are removed. **DO NOT REMOVE INSIDE BLADE FLANGE.**

6. Make sure the inside surfaces of both the inside and outside blade flanges are clean and free from any foreign substance.

7. Make sure the inside blade flange is completely on arbor with the flats in the flange engaged with the flats on the arbor.

8. Install new blade (H) Fig. 42, outside blade flange (G), arbor washer (F) and arbor screw (D). Turn arbor screw (D) counterclockwise to tighten while pressing in on arbor lock (E) Fig. 43, to keep arbor from turning. **IMPORTANT:** Make sure flats in outside blade flange (G) Fig. 42, are engaged with flats on arbor shaft and that teeth of saw blade (H) are pointing down at the front, as shown in Fig. 42.

9. Rotate plate (C) Fig. 41, until hook in plate is engaged under rubber washer and tighten screw (B).

10. Place lower blade guard (A) Fig. 40, in the down position.

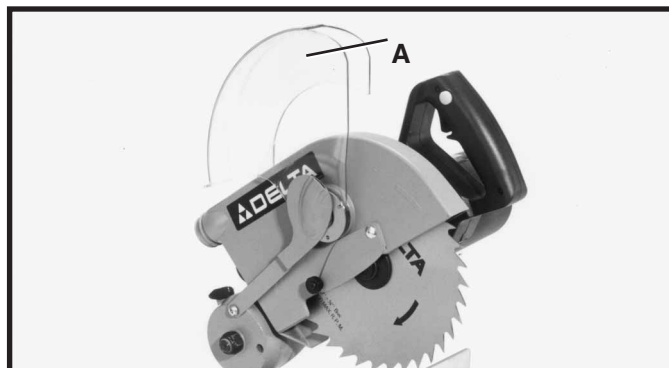

Fig. 40



Fig. 41

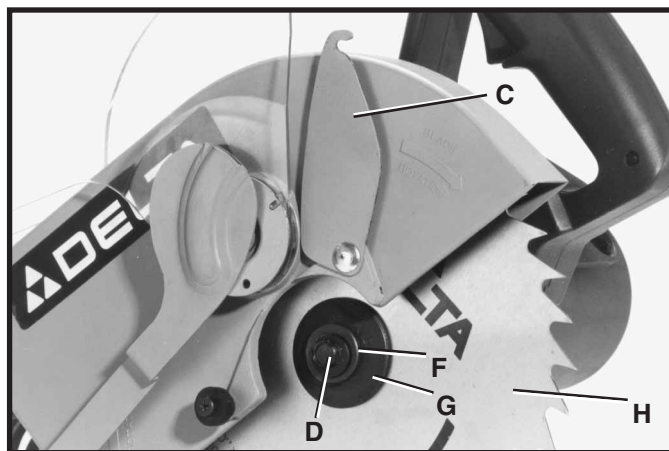

Fig. 42

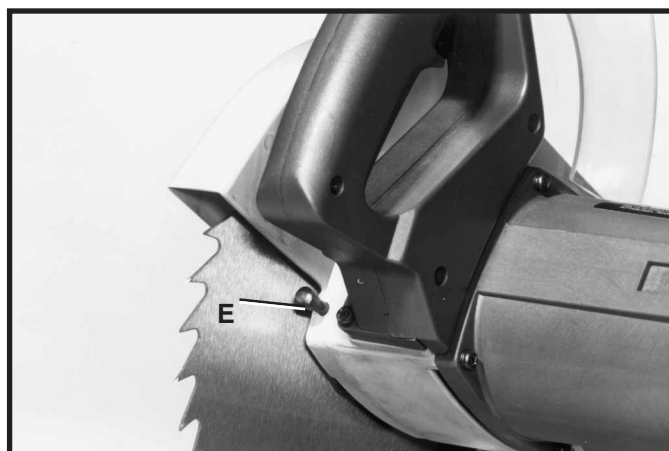

Fig. 43

BRUSH INSPECTION AND REPLACEMENT

CAUTION: BEFORE INSPECTING BRUSHES, DISCONNECT THE MACHINE FROM THE POWER SOURCE.

Brush life varies. It depends on the load on the motor. Check the brushes after the first 50 hours of use for a new machine or after a new set of brushes has been installed.

After the first check, examine them after about 10 hours of use until such time that replacement is necessary.

The brush holders (A) Fig. 44, are located on the motor housing opposite each other. Fig. 45, illustrates one of the brushes removed for inspection. When the carbon on either brush is worn to 3/16" in length or if either spring or shunt wire is burned or damaged in any way, replace both brushes. If the brushes are found serviceable after removing, reinstall them in the same position as removed.

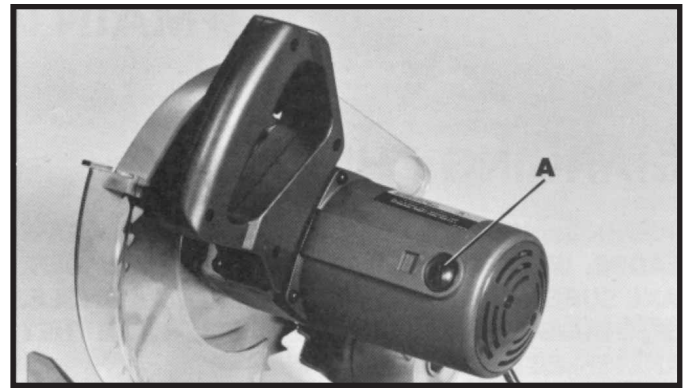



Fig. 44



Fig. 45

ACCESSORIES

A complete line of accessories are available from your Delta Supplier, Porter-Cable • Delta Factory Service Centers, and Delta Authorized Service Stations. Please visit our Web Site www.deltamachinery.com for a catalog or for the name of your nearest supplier.

 **WARNING:** Since accessories, other than those offered by Delta, have not been tested with this product, use of such accessories could be hazardous. For safest operation, only Delta recommended accessories should be used with this product.

36-221

WORK CLAMP



PARTS, SERVICE OR WARRANTY ASSISTANCE

All Delta Machines and accessories are manufactured to high quality standards and are serviced by a network of Porter-Cable • Delta Factory Service Centers and Delta Authorized Service Stations. To obtain additional information regarding your Delta quality product or to obtain parts, service, warranty assistance, or the location of the nearest service outlet, please call 1-800-223-7278 (In Canada call 1-800-463-3582).



Delta Building Trades and Home Shop Machinery Two Year Limited Warranty

Delta will repair or replace, at its expense and at its option, any Delta machine, machine part, or machine accessory which in normal use has proven to be defective in workmanship or material, provided that the customer returns the product prepaid to a Delta factory service center or authorized service station with proof of purchase of the product within two years and provides Delta with reasonable opportunity to verify the alleged defect by inspection. Delta may require that electric motors be returned prepaid to a motor manufacturer's authorized station for inspection and repair or replacement. Delta will not be responsible for any asserted defect which has resulted from normal wear, misuse, abuse or repair or alteration made or specifically authorized by anyone other than an authorized Delta Service facility or representative. Under no circumstances will Delta be liable for incidental or consequential damages resulting from defective products. This warranty is Delta's sole warranty and sets forth the customer's exclusive remedy, with respect to defective products; all other warranties, express or implied, whether of merchantability, fitness for purpose, or otherwise, are expressly disclaimed by Delta.

NOTES

NOTES

PORTER-CABLE • DELTA SERVICE CENTERS (CENTROS DE SERVICIO DE PORTER-CABLE • DELTA)

Parts and Repair Service for Porter-Cable/Delta Power Tools are Available at These Locations
(Obtenga Refaccion de Partes o Servicio para su Herramienta en los Siguientes Centros de Porter-Cable•Delta)

ARIZONA

Tempe 85282 (Phoenix)
2400 West Southern Avenue
Suite 105
Phone: (602) 437-1200
Fax: (602) 437-2200

CALIFORNIA

Ontario 91761 (Los Angeles)
3949A East Guasti Road
Phone: (909) 390-5555
Fax: (909) 390-5554

San Leandro 94577 (Oakland)
3039 Teagarden Street
Phone: (510) 357-9762
Fax: (510) 357-7939

COLORADO

Denver 80216
5855 Stapleton Drive North
Suite A-140
Phone: (303) 370-6909
Fax: (303) 370-6969

FLORIDA

Davie 33314 (Miami)
4343 South State Rd. 7 (441)
Unit #107
Phone: (954) 321-6635
Fax: (954) 321-6638

Tampa 33609
4538 W. Kennedy Boulevard
Phone: (813) 877-9585
Fax: (813) 289-7948

GEORGIA

Forest Park 30297 (Atlanta)
5442 Frontage Road,
Suite 112
Phone: (404) 608-0006
Fax: (404) 608-1123

ILLINOIS

Addison 60101 (Chicago)
311 Laura Drive
Phone: (630) 628-6100
Fax: (630) 628-0023

Woodridge 60517 (Chicago)
2033 West 75th Street
Phone: (630) 910-9200
Fax: (630) 910-0360

MARYLAND

Elkridge 21075 (Baltimore)
7397-102 Washington Blvd.
Phone: (410) 799-9394
Fax: (410) 799-9398

MASSACHUSETTS

Braintree 02185 (Boston)
719 Granite Street
Phone: (781) 848-9810
Fax: (781) 848-6759

Franklin 02038 (Boston)
Franklin Industrial Park
101E Constitution Blvd.
Phone: (508) 520-8802
Fax: (508) 528-8089

MICHIGAN

Madison Heights 48071 (Detroit)
30475 Stephenson Highway
Phone: (248) 597-5000
Fax: (248) 597-5004

MINNESOTA

Minneapolis 55429
4315 68th Avenue North
Phone: (612) 561-9080
Fax: (612) 561-0653

MISSOURI

North Kansas City 64116
1141 Swift Avenue
P.O. Box 12393
Phone: (816) 221-2070
Fax: (816) 221-2897

St. Louis 63119
7574 Watson Road
Phone: (314) 968-8950
Fax: (314) 968-2790

NEW YORK

Flushing 11365-1595 (N.Y.C.)
175-25 Horace Harding Expwy.
Phone: (718) 225-2040
Fax: (718) 423-9619

NORTH CAROLINA

Charlotte 28270
9129 Monroe Road, Suite 115
Phone: (704) 841-1176
Fax: (704) 708-4625

OHIO

Columbus 43214
4560 Indianola Avenue
Phone: (614) 263-0929
Fax: (614) 263-1238

Cleveland 44125
8001 Sweet Valley Drive
Unit #19
Phone: (216) 447-9030
Fax: (216) 447-3097

OREGON

Portland 97230
4916 NE 122 nd Ave.
Phone: (503) 252-0107
Fax: (503) 252-2123

PENNSYLVANIA

Willow Grove 19090
520 North York Road
Phone: (215) 658-1430
Fax: (215) 658-1433

TENNESSEE

Nashville 37214
2262 Lebanon Pike
Phone: (615) 882-0320
Fax: (615) 882-0051

TEXAS

Carrollton 75006 (Dallas)
1300 Interstate 35 N, Suite 112
Phone: (972) 446-2996
Fax: (972) 446-8157

Houston 77055
West 10 Business Center
1008 Wirt Road, Suite 120
Phone: (713) 682-0334
Fax: (713) 682-4867

WASHINGTON

Renton 98055 (Seattle)
268 Southwest 43rd Street
Phone: (425) 251-6680
Fax: (425) 251-9337

Authorized Service Stations are located in many large cities. Telephone **800-487-8665** or **901-541-6042** for assistance locating one. Parts and accessories for Porter-Cable •Delta products should be obtained by contacting any Porter-Cable•Delta Distributor, Authorized Service Center, or Porter-Cable•Delta Factory Service Center. If you do not have access to any of these, call **888-848-5175** and you will be directed to the nearest Porter-Cable•Delta Factory Service Center. Las Estaciones de Servicio Autorizadas están ubicadas en muchas grandes ciudades. Llame al **800-487-8665** ó al **901-541-6042** para obtener asistencia a fin de localizar una. Las piezas y los accesorios para los productos Porter-Cable•Delta deben obtenerse poniéndose en contacto con cualquier distribuidor Porter-Cable•Delta, Centro de Servicio Autorizado o Centro de Servicio de Fábrica Porter-Cable•Delta. Si no tiene acceso a ninguna de estas opciones, llame al **888-848-5175** y le dirigirán al Centro de Servicio de Fábrica Porter-Cable•Delta más cercano.

CANADIAN PORTER-CABLE • DELTA SERVICE CENTERS

ALBERTA

Bay 6, 2520-23rd St. N.E.
Calgary, Alberta
T2E 8L2
Phone: (403) 735-6166
Fax: (403) 735-6144

BRITISH COLUMBIA

8520 Baxter Place
Burnaby, B.C.
V5A 4T8
Phone: (604) 420-0102
Fax: (604) 420-3522

MANITOBA

1699 Dublin Avenue
Winnipeg, Manitoba
R3H 0H2
Phone: (204) 633-9259
Fax: (204) 632-1976

ONTARIO

505 Southgate Drive
Guelph, Ontario
N1H 6M7
Phone: (519) 836-2840
Fax: (519) 767-4131

QUÉBEC

1515 ave.
St-Jean Baptiste,
Québec, Québec
G2E 5E2
Phone: (418) 877-7112
Fax: (418) 877-7123

1447, Begin
St-Laurent, (Montréal),
Québec
H4R 1V8
Phone: (514) 336-8772
Fax: (514) 336-3505

The following are trademarks of PORTER-CABLE•DELTA Corporation (Las siguientes son marcas registradas de PORTER-CABLE S.A.): BAMMER®, INNOVATION THAT WORKS®, JETSTREAM®, LASERLOC®, OMNIGIG®, POCKET CUTTER®, PORTA-BAND®, PORTA-PLANE®, PORTER-CABLE®, QUICKSAND®, SANDTRAP®, SAW BOSS®, SPEED-BLOC®, SPEEDMATIC®, SPEEDTRONIC®, STAIR-EASE®, THE PROFESSIONAL EDGE®, THE PROFESSIONAL SELECT®, TIGER CUB®, TIGER SAW®, TORQBUSTER®, WHISPER SERIES®, DURATRONIC™, FLEX™, FRAME SAW™, MICRO-SET™, MORTEN™, NETWORK™, RIPTIDE™, TRU-MATCH™, WOODWORKER'S CHOICE™.

Trademarks noted with ® are registered in the United States Patent and Trademark Office and may also be registered in other countries. Las Marcas Registradas con el signo de ® son registradas por la Oficina de Registros y Patentes de los Estados Unidos y también pueden estar registradas en otros países.

Free Manuals Download Website

<http://myh66.com>

<http://usermanuals.us>

<http://www.somanuals.com>

<http://www.4manuals.cc>

<http://www.manual-lib.com>

<http://www.404manual.com>

<http://www.luxmanual.com>

<http://aubethermostatmanual.com>

Golf course search by state

<http://golfingnear.com>

Email search by domain

<http://emailbydomain.com>

Auto manuals search

<http://auto.somanuals.com>

TV manuals search

<http://tv.somanuals.com>