

## VFDB 4132 Series Brake Modules

### Instruction Sheet

#### 1 Preface

Thank you for choosing DELTA's brake module. VFDB brake units are applied to absorb the motor regeneration energy when the three-phase induction motor stops by deceleration. With VFDB brake unit, the regeneration energy will be dissipated in dedicated brake resistors. To prevent mechanical or human injury, please refer to this instruction sheet before wiring. VFDB brake units are suitable for DELTA AC Motor Drives VFD Series 230V/460V/575V. VFDB brake units need to be used in conjunction with BR series brake resistors to provide the optimum brake characteristics. VFDB brake units (4132) are approved by Underwriters Laboratories, Inc. (UL) and Canadian Underwriters Laboratories (cUL). The content of this instruction sheet may be revised without prior notice. Please consult our distributors or download the most updated version at <http://www.delta.com.tw/industrialautomation>.

#### 2 Specifications

VFDB 4132 Brake Units		
Specification	460V Series	
Max. Motor Capacity (kW)	132	
Max. Discharge Current (A) 10%ED	240	
Continuous Discharge Current (A)	75	
Braking Start-up Voltage (DC)	618/642/667/690/725/750±6V	
Input Rating	DC Voltage 480-750VDC	
Min. Equivalent Resistor for Each Brake Unit	3.4Ω	
Protection	Heat Sink Overheat Temperature	Temperature exceeds +95°C (203°F)
	Alarm Output for Overheat	Relay contact 3A250VAC/30VDC (RA, RC)
	Power Charge Display	ON until the bus (P-N) voltage is below 50VDC
Environment	Over-current Protection Level	320A
	Installation Location	Indoor (no corrosive gases, metallic dust)
	Operating Temperature	-10°C~+50°C (14°F to 122°F)
	Storage Temperature	-20°C ~+60°C (-4°F to 140°F)
	Humidity	Less than 90% Non-condensing
Mechanical Configuration	Vibration	9.8m/s <sup>2</sup> (1G) under 20Hz / 2m/s <sup>2</sup> (0.2G) at 20~50Hz
		Wall-mounted enclosed type IP10

Brake Resistors	
Model no.	Specification
BR1K5W005	1500W 5.0Ω
BR1K2W6P8	1200W 6.8Ω
BR1K2W008	1200W 8.0Ω
BR1K5W040	1500W 40Ω
BR1K0W050	1000W 50Ω
BR1K0W075	1000W 75Ω

#### 3 Dimensions

##### 3.1 Brake resistor

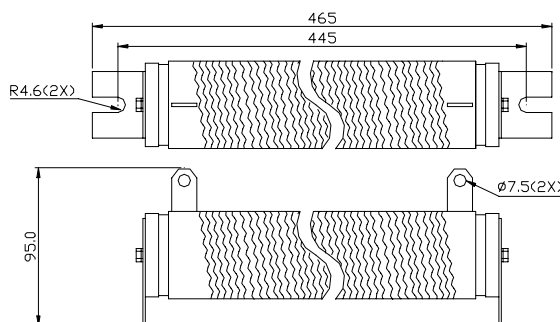

##### 3.2 Brake unit

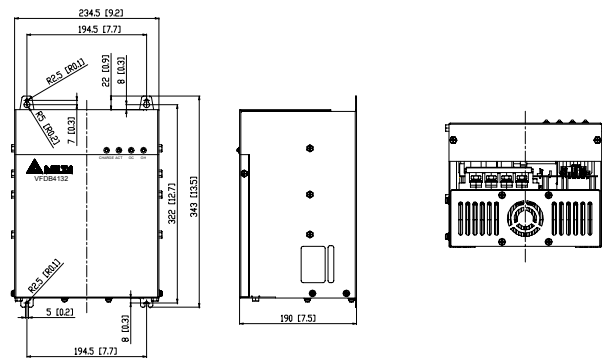

#### 4 Internal Components and Terminals

##### 4.1 Internal Components

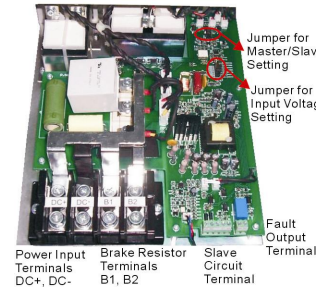

##### 4.2 Wire Gauge for Terminals

Circuit	Terminals	Wire Gauge AWG (mm <sup>2</sup> )	Screw	Torque
Power Input Circuit	DC+, DC-	4~6AWG (13.3~21.2mm <sup>2</sup> )	M8	30 kgf-cm (26 in-lbf)
Brake Resistor	B1, B2	4~6AWG (13.3~21.2mm <sup>2</sup> )	M8	30 kgf-cm (26 in-lbf)
SLAVE Circuit	Output M1, M2 Input S1, S2	18~20AWG (0.8~0.5mm <sup>2</sup> ) (With shielded wires)	M2	4 kgf-cm (3 in-lbf)
Fault Circuit	RA, RC	18~20AWG (0.8~0.5mm <sup>2</sup> )	M2	4 kgf-cm (3 in-lbf)

#### 5 Basic Wiring Diagram

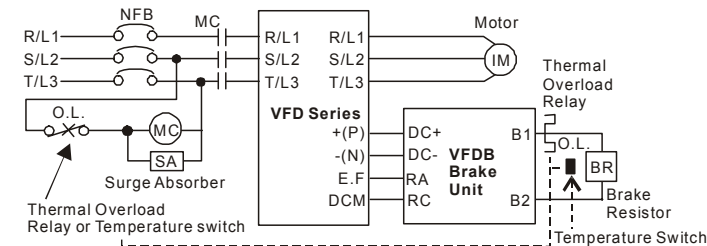

Note 1: When the AC motor drive is used with DC reactor, please refer to the wiring diagram in the AC drive user manual for wiring terminal DC+ of brake unit.

Note 2: **DO NOT** wire terminal DC- to the neutral point of power system.

##### NOTE

- For safety consideration, install an overload relay between the brake unit and the brake resistor. In conjunction with the magnetic contactor (MC) prior to the drive, it can perform complete protection against abnormality.
- The purpose of installing the thermal overload relay is to protect the brake resistor from damage due to frequent brake, or due to brake unit keeping operating resulted from unusual high input voltage. Under such circumstance, just turn off the power to prevent damaging the brake resistor.
- Please refer to the specification of the thermal overload relay.
- The alarm output terminals (RA, RC) of the brake unit will be activated when the temperature of the heat sink exceeds 95°C. It means that the temperature of the installation environment may exceed 50°C, or the brake %ED may exceed 10%ED. With this kind of alarm, please install a fan to force air-cooling or reduce the environment temperature. If the condition not due to the temperature, the control circuit or the temperature sensor may have been damaged. At this time, please send the brake unit back to the manufacturer or agency for repair.
- The AC Motor Drive and brake unit will be electrified at the same time while turning on the NFB (No-fuse breaker). For the operation/stop method of the motor, please refer to the user manual of the AC Motor Drives VFD Series. The brake unit will detect the inner DC voltage of the AC motor drive when it stops the motor by deceleration. The extra regeneration will be dissipated away rapidly by the brake resistor in the form of heat. It can ensure the stable deceleration characteristic.
- Besides, using thermal overload relay to be the protection system and brake resistor, temperature switch can be installed on brake resistor side as the protection. The temperature switch must comply with the brake resistor specification or contact your dealer.

#### 6 Wiring Warnings

- Do not proceed with wiring while power is applied to the circuit.
- The wiring gauge and distance must comply with the local regulations.
- The +(P), -(N) terminals of the AC motor drive (VFD Series), connected to the brake unit (VFDB), must be confirmed for correct polarity lest the drive and the brake unit be damaged when power on.
- When the brake unit performs braking, the wires connected to DC+, DC-, B1 and B2 would generate a powerful electromagnetic field for a moment due to high current passing through. These wires should be wired separately from other low voltage control circuits lest they make interference or mis-operation.
- Inflammable solids, gases or liquids must be avoided at the location where the brake resistor is installed. The brake resistor had better be installed in individual metallic box with forced air-cooling.
- Connect the ground terminal to the Earth Ground. The ground lead must be at least the same gauge wire as leads DC+, DC-.
- Please install the brake resistor with forced air-cooling or the equivalent when frequent deceleration braking is performed (over 10%ED).
- Do NOT change any wirings and settings and touch any terminals and components while power is applied to avoid electric shock.
- It is recommended to use the ring terminals for main circuit wiring. Make sure the terminals are fastened before power on.
- Wiring distance

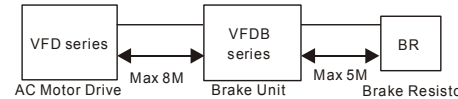

#### 7 Definition for the Brake Usage ED%

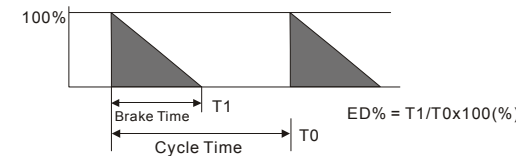

The definition of the brake usage ED(%) is to assure having enough time for the brake unit and brake resistor to dissipate the heat generated by brake. When the brake resistor heats up, the resistance would increase with temperature, and brake torque would decrease accordingly.

#### 8 The Voltage Settings

- Voltage setting: the power source of the brake unit is DC voltage from +(P), -(N) terminals of the AC motor drive. It is very important to set the voltage of the brake unit based on the actual input power of the AC motor drive before operation. The setting has a great influence on the potential of the operation voltage for the brake unit. Please refer to the table below.

##### NOTE

- Before changing the setting of the power voltage, make sure the power has been turned off. Please set power voltage as the possible highest voltage for unstable power system. Take 380VAC power system for example. If the voltage may be up to 410VAC, 415VAC should be set.
- For DELTA's AC motor drive (VFD Series), please set parameter (Over Voltage Stall Prevention) as "close" to disable over-voltage stall prevention, to ensure stable deceleration characteristic.

Table 1: The Selection of AC Power Voltage and Voltage Setting

AC Power Voltage	Brake Start-up voltage DC Bus (DC+, DC-) Voltage
380VAC (460V Mode)	618VDC
400VAC (460V Mode)	642VDC
415VAC (460V Mode)	667VDC
440VAC (460V Mode)	690VDC
460VAC (460V Mode)	725VDC
480VAC (460V Mode)	750VDC

NOTE: Input Power With Tolerance ±10%

##### Input voltage setting for VFDB 4132

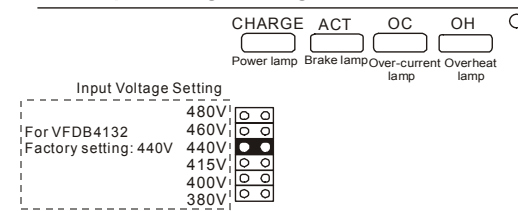

- MASTER (M) /SLAVE (S) setting: the factory setting is "M". The "S" setting is applied to two or more brake units in parallel, making these brake units be enabled/disabled synchronously. Then the power dissipation of each unit will be equivalent so that they can perform the brake function completely.

In the following diagram, it shows jumper setting for the application of three brake units. After wiring, the jumper in the first brake unit should be set to "M" and others must be set to "S" to complete the system setting.

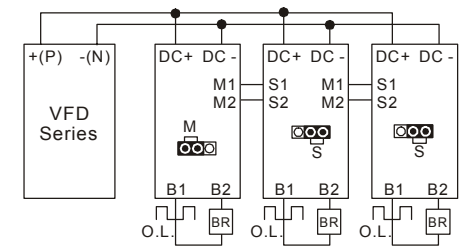

The Position of the Jumper

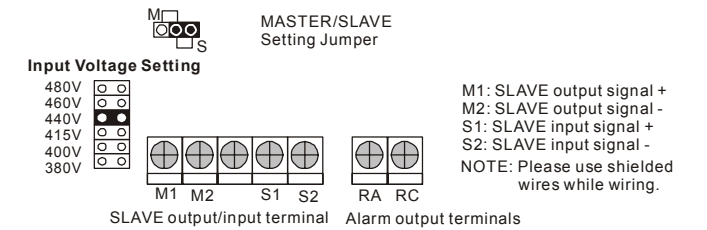

##### NOTE

- Please make sure that power is OFF before setting the jumper.
- The steps for jumper setting:  
Step 1. Remove the top cover.  
Step 2. Remove the screws on the side case (3 screws for each side).  
Step 3. Remove the screws that connected bottom case to the side case (2 screws for each side).  
Step 4. After removing the power line of the fan, pull out the heat sink slowly until the jumper can be seen. Then the jumper can be set.

#### 9 Brake Resistors/Units for Delta VFD AC Motor Drives Series

Voltage	Applicable Motor		Full-load Torque kg-M	Resistor Value Spec. for Each AC Motor Drive	Brake Unit Part No. and Quantity	Brake Resistors Part No. and Quantity	Brake Torque 10%ED	Min. Equivalent Resistor Value for Each AC Motor Drive	Typical Thermal Overload Relay Value
	HP	kW							
460V	120	90	52.5	13500W 5Ω	4132 1	BR1K5W005 9	120	5Ω	110A
	150	110	61	21600W 4Ω	4132 1	BR1K2W008 18	120	4Ω	135A
	175	132	73.5	21600W 4Ω	4132 1	BR1K2W008 18	100	4Ω	135A
	215	160	89	21600W 3.4Ω	4132 1	BR1K2W6P8 18	97	3.4Ω	160A
	250	185	103	27000W 2.5Ω	4132 2	BR1K5W005 18	115	2.5Ω	220A
	300	220	122.5	27000W 2.5Ω	4132 2	BR1K5W005 18	96	2.5Ω	220A

#### 10 Examples

##### NOTE

- Before wiring, please notice equivalent resistors value shown in the column "Equivalent resistors specification for each brake unit" in the above table to prevent damage.

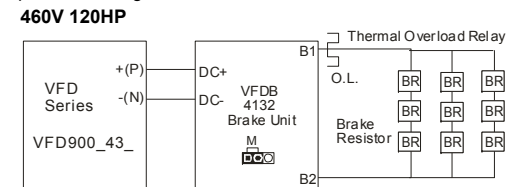

VFD900\_43 uses with 3 BR sets in parallel, which 3PCS 1K5W005 brake resistors are connected in series.

##### 460V 150HP, 175HP, 215HP

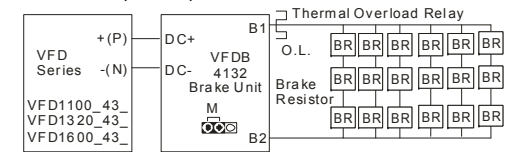

VFD1100\_43 uses with 6 BR sets in parallel, which 3PCS 1K2W008 brake resistors are connected in series.

VFD1320\_43 uses with 6 BR sets in parallel, which 3PCS 1K2W008 brake resistors are connected in series.

VFD1600\_43 uses with 6 BR sets in parallel, which 3PCS 1K2W6P8 brake resistors are connected in series.

##### 460V 250HP, 300HP

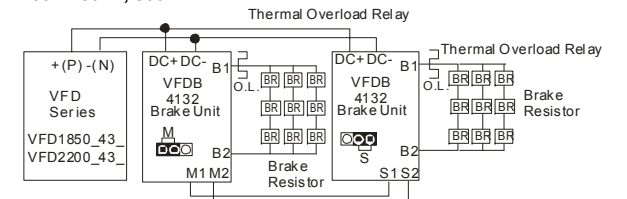

VFD1850\_43 uses with 2 VFDB4132 brake units and each brake unit uses with 3 BR sets in parallel, which 3PCS 1K5W005 brake resistors are connected in series. VFD2200\_43 uses with 2 VFDB4132 brake units and each brake unit uses with 3 BR sets in parallel, which 3PCS 1K5W005 brake resistors are connected in series.



# VFDB4132 系列煞車模組

## 說明書

### 1 前言

感謝您選用台達 VFDB 動力制動煞車模組。本產品主要應用於當三相感應馬達由交流馬達驅動器所驅動，在減速停止時用以吸收由馬達側所回生的能量。藉由 VFDB 制動單元將此能量以熱能的方式消耗在煞車電阻上。本產品在安裝使用前，請詳細參閱本說明書再進行施工配線，以免造成機械或人員的傷害。VFDB 動力制動煞車模組適用於本公司 VFD 所有系列的交流馬達驅動器。VFDB 制動單元需搭配煞車電阻 BR 系列，才能發揮優異的制動特性，詳細的規格及使用方法請繼續參閱本說明書。由於產品精益求精，當內容規格有所修正時，請洽詢代理商或至台達網站 (<http://www.delta.com.tw/industrialautomation/>) 下載最新版本。

### 2 規格

VFDB 4132 制動單元規格		
<b>使用電壓等級</b>	<b>460V 系列</b>	
最大適用馬達容量 (kW)	132	
輸出額定	最大放電電流(A peak) 10%ED	240
	連續放電電流 (A)	75
	制動起始電壓 (DC)	618/642/667/690/725/750±6V
電源	直流電壓	480-750VDC
	每台等效最小電阻	3.4Ω
保護	散熱片過熱溫度	溫度超過 +95°C (203°F)
	過熱故障輸出	RELAY 接點 3A250Vac/30Vdc(RA,RC)
	充電中顯示	主回路 (P-N) 電壓在 50VDC 以下熄滅
	過電流 OC 保護準位	320A
使用環境	安裝場所	屋內 (無腐蝕性氣體、金屬粉塵)
	環境溫度	-10°C~+50°C (14°F to 122°F)
	儲存溫度	-20°C~+60°C (-4°F to 140°F)
	濕度	90%RH 以下不結露
	振動	20Hz 以下 9.8m/S <sup>2</sup> (1G) -20~50Hz 2m/S <sup>2</sup> (0.2G)
機機構造	壁掛型 IP10	

煞車電阻	
型號	規格
BR1K5W005	1500W 5.0Ω
BR1K2W6P8	1200W 6.8Ω
BR1K2W008	1200W 8.0Ω
BR1K5W040	1500W 40Ω
BR1K0W050	1000W 50Ω
BR1K0W075	1000W 75Ω

### 3 尺寸

#### 3.1 煞車電阻

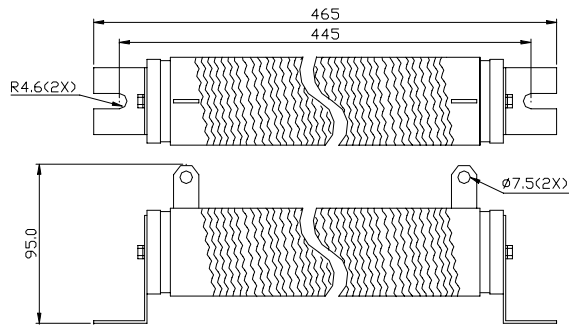

### 3.2 VFDB 4132 制動單元

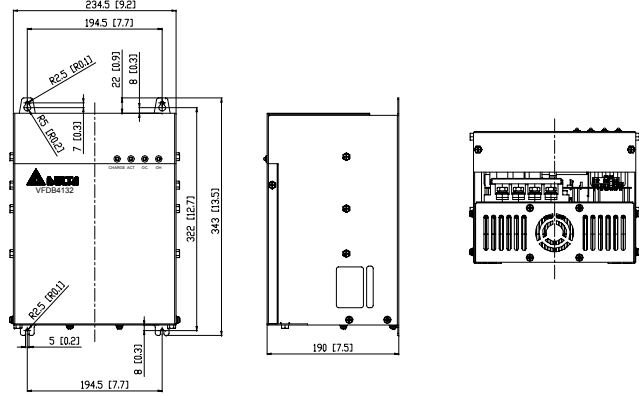

### 4 各部名稱及功能說明

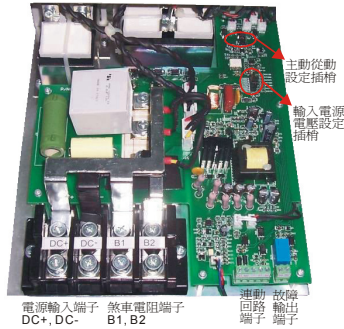

#### 4.1 各端子使用線徑

回路名稱	端子記號	導線線徑 AWG (mm <sup>2</sup> )	螺絲規格	扭力
電源輸入回路	DC+, DC-	4~6AWG (13.3~21.2mm <sup>2</sup> )	M8	30 kgf-cm (26 in-lbf)
煞車電阻回路	B1, B2	4~6AWG (13.3~21.2mm <sup>2</sup> )	M8	30 kgf-cm (26 in-lbf)
連動回路	輸出 M1, M2	18~20AWG (0.8~0.5mm <sup>2</sup> ) (需用隔離線)	M2	4 kgf-cm (3 in-lbf)
	輸入 S1, S2	18~20AWG (0.8~0.5mm <sup>2</sup> )	M2	4 kgf-cm (3 in-lbf)
故障回路	RA, RC	18~20AWG (0.8~0.5mm <sup>2</sup> )	M2	4 kgf-cm (3 in-lbf)

### 5 基本配線圖

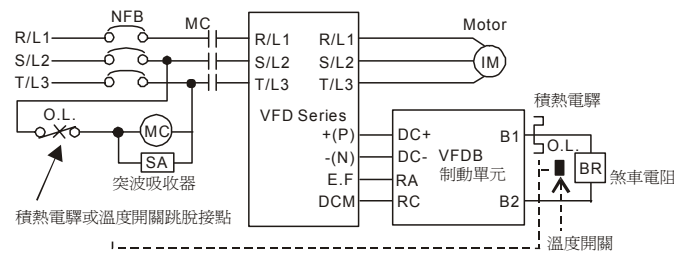

- 當交流馬達驅動器有加裝直流電抗器(DC Reator)時，其煞車模組之電源輸入迴路DC+端的配線方法，可參考交流馬達驅動器手冊。
- 請勿將電源輸入迴路DC-端，接至電力系統之中性點。

### NOTE

- 在安裝制動單元的應用中為了安全的考量，在制動單元與煞車電阻之間加裝一積熱電驛 (O.L.)；並與交流馬達驅動器前端的電磁接觸器 (MC) 作一連鎖的異常保護。
- 加裝積熱電驛的主要目的是為了保護煞車電阻不因煞車頻繁過熱而燒毀，或是因輸入電源電壓異常過高導致制動單元連續導通燒毀煞車電阻。此時只有將交流馬達驅動器的電源關閉才可避免煞車電阻燒毀。
- 積熱電驛規格的選用請參考制動單元與放電電阻適用一覽表。
- 制動單元中的故障輸出端子 (RA、RC) 在散熱裝置溫度高於 95°C 時會動作，表示安裝環境溫度可能超過 50°C 以上，或是煞車制動 ED% 超過 10%ED；若是此類的故障請自行加裝風扇強制風冷或改善環境溫度。若非溫度原因，可能控制電路受損或溫度感測器故障，此時請送廠維修。
- 本配線電路在電源開關 (NFB) 開啓時交流馬達驅動器與制動單元便同時通上電源，馬達的運轉/停止的方式請參考 VFD 系列的使用手冊；制動單元會在交流馬達驅動器對馬達作減速煞車時自動偵測交流馬達驅動器內部的直流電壓，自動將過多的回生能量藉由煞車電阻以熱能的方式迅速消耗以達平穩的減速特性。
- 除了使用積熱電驛作為保護系統及制動電阻外，尚可加裝溫度開關於制動電阻端作為保護。溫度開關的動作溫度需配合制動電阻規格，或洽詢經銷商詢問。

### 6 配線注意事項

- 進行配線施工時務必確認相關回路電源均為關閉狀態；配線的線徑及距離亦務必按照規定選用及施工。
- 交流馬達驅動器 (VFD) 連接至制動單元 (VFDB) 的 DC+、DC- 端子有極性之分，千萬要確認再確認，否則電源一開啓制動單元立即炸毀，請務必注意。
- 制動單元在執行煞車時，DC+、DC-、B1、B2 因有大電流通過所連接的導線瞬間將產生能量很大的電磁場；故在初期配線施工規劃時，應與其它低電壓的控制線路分離配線，以免造成不必要的干擾或誤動作。
- 煞車電阻安裝的場所不能有易燃性的物體、氣體、液體，最好能安裝在獨立的金屬箱內並加以風扇散熱。
- 制動單元的接地工程 230V 級請依第三種接地施工，460V 級請依特別第三種接地施工。
- 在減速煞車頻繁的場合 (超過 10%ED) 煞車電阻請加裝風扇強制風冷或其它冷卻設備。
- 在通電中嚴禁修改任何配線及制動單元內部設定，更嚴禁在通電中碰觸相關配線的端子及 PCB 板中的任一元件，以免因通電中遭極度危險的直流高壓感電造成人員傷害。
- 所有的主回路端子請使用 O 型端子配線，並確認端子已鎖緊方可送電運行。
- 配線距離

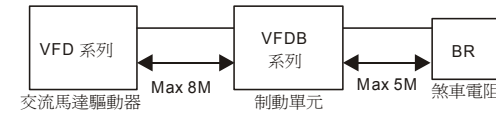

### 7 煞車使用率 ED% 的定義

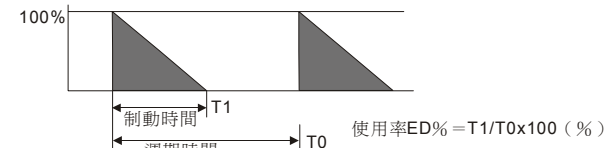

制定煞車使用率 ED%，主要是為了能讓制動單元及煞車電阻有充份的時間來散除因制動而產生的熱量；當煞車電阻發熱時，電阻值將會隨溫度的上昇而變高，制動轉矩亦隨之減少。

### 8 設定與調整

- 電源電壓的調整：制動單元的電力來源是接受交流馬達驅動器+ (P)、- (N) 兩端供應的直流電源。因此，在配線完成準備運轉時，依交流馬達驅動器的實際輸入電源來設定制動單元的電源電壓是非常重要的步驟；此設定將會影響制動單元動作電壓的位準，下表為各個電壓動作準位。

### NOTE

- 設定電源電壓時，請務必先將電源關閉後才可更改設定值。若在電源電壓不穩定的區域，請將電源電壓設定在可能出現的最高電壓。例如：380Vac 的電源系統，若電壓變動達到 410Vac，請設定在 415Vac。
- 使用本公司 VFD 系列交流馬達驅動器，請將參數的過電壓失速防止功能設定為關閉狀態，使失速防止功能失效，如此可得穩定的減速特性。

表一：電源電壓的選擇與 PN 直流電壓的動作準位

AC 電源電壓	制動開始電壓 DC+、DC- 母線 DC 電壓
380Vac (460V Mode)	618Vdc
400Vac (460V Mode)	642Vdc
415Vac (460V Mode)	667Vdc
440Vac (460V Mode)	690Vdc
460Vac (460V Mode)	725Vdc
480Vac (460V Mode)	750Vdc

註：容許輸入電源有±10%的變動

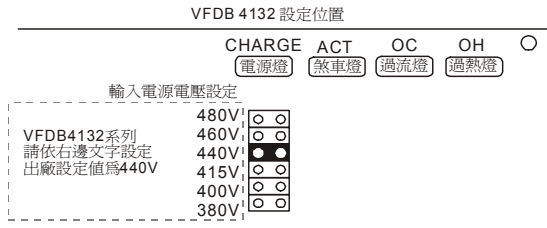

- 主動 (M) / 連動 (S) 的設定：制動單元在出廠時均設定在 "M" 主動煞車的位置。"S" 連動位置的功能主要是應用於兩台以上制動單元。

如下圖所示為三台制動單元連動制動的應用；當配線完成後需將第一台設為 "M" 主動的設定，其餘的一定要將插梢設定在 "S" 連動的位置上，如此即可完成動力制動系統的配線。

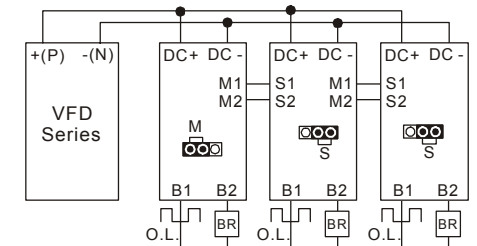

VFDB 4132 設定位置

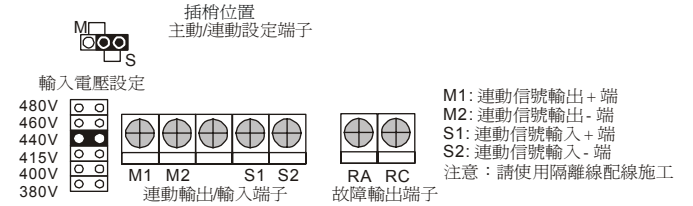

### NOTE

- 必須在關電的狀態下，才能切換插梢位置。
- 切換插梢位置動作順序：卸下上蓋，然後卸下外殼兩旁螺絲共六顆 (左右各三顆)，再卸下風扇組與外殼間的螺絲共四顆 (左右各二顆)。此時，須拔除風扇組的電源線後，將散熱片緩慢抽出至露出插梢即可，然後切換插梢位置。

### 9 制動單元與放電電阻適用一覽表

電壓	適用馬達		全載輸出轉矩 kg-M	每台交流馬達驅動器等效煞車電阻規格	制動單元	制動電阻料號	制動轉矩 10%ED	每台交流馬達驅動器等效最小電阻值		積熱電驛規格中心值
	HP	kW						電阻值	電阻值	
460V	120	90	52.5	13500W 5Ω	4132 1	BR1K5W005	9	120	5Ω	110A
	150	110	61	21600W 4Ω	4132 1	BR1K2W008	18	120	4Ω	135A
	175	132	73.5	21600W 4Ω	4132 1	BR1K2W008	18	100	4Ω	135A
	215	160	89	21600W 3.4Ω	4132 1	BR1K2W6P8	18	97	3.4Ω	160A
	250	185	103	27000W 2.5Ω	4132 2	BR1K5W005	18	115	2.5Ω	220A
	300	220	122.5	27000W 2.5Ω	4132 2	BR1K5W005	18	96	2.5Ω	220A

### 10 制動電阻配線圖例

### NOTE

- 在配線前，注意：每台煞車模組之等效煞車電阻不能低於每台制動單元最小等效電阻值 (參閱制動單元與放電電阻適用一覽表)。

#### 460V 120HP

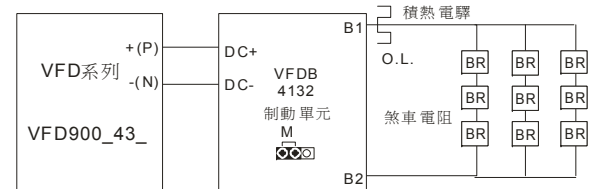

VFD900\_43\_使用BR1K5W005 9PCS，每3PCS串聯後再並聯接線

#### 460V 150HP, 175HP, 215HP

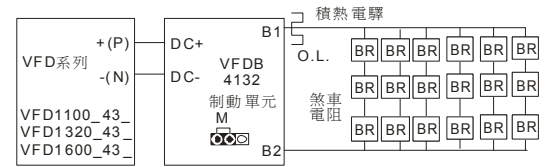

VFD1100\_43\_使用1K2W008 18PCS，每3PCS串聯後再並聯接線  
VFD1320\_43\_使用1K2W008 18PCS，每3PCS串聯後再並聯接線  
VFD1600\_43\_使用1K2W6P8 18PCS，每3PCS串聯後再並聯接線

#### 460V 250HP, 300HP

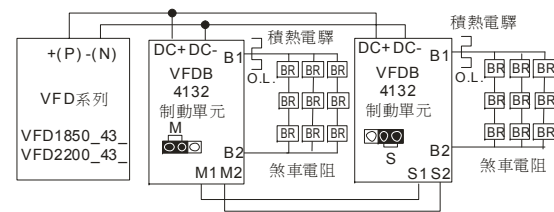

VFD1850\_43\_使用2台VFDB4132制動單元，每4台使用BR1K5W005 9PCS，每3PCS串聯後再並聯接線  
VFD2200\_43\_使用2台VFDB4132制動單元，每4台使用BR1K5W005 9PCS，每3PCS串聯後再並聯接線

## Free Manuals Download Website

<http://myh66.com>

<http://usermanuals.us>

<http://www.somanuals.com>

<http://www.4manuals.cc>

<http://www.manual-lib.com>

<http://www.404manual.com>

<http://www.luxmanual.com>

<http://aubethermostatmanual.com>

Golf course search by state

<http://golfingnear.com>

Email search by domain

<http://emailbydomain.com>

Auto manuals search

<http://auto.somanuals.com>

TV manuals search

<http://tv.somanuals.com>