

Sidekick 10" Motorized Miter Box

(Model 36-090)

INSTRUCTION MANUAL

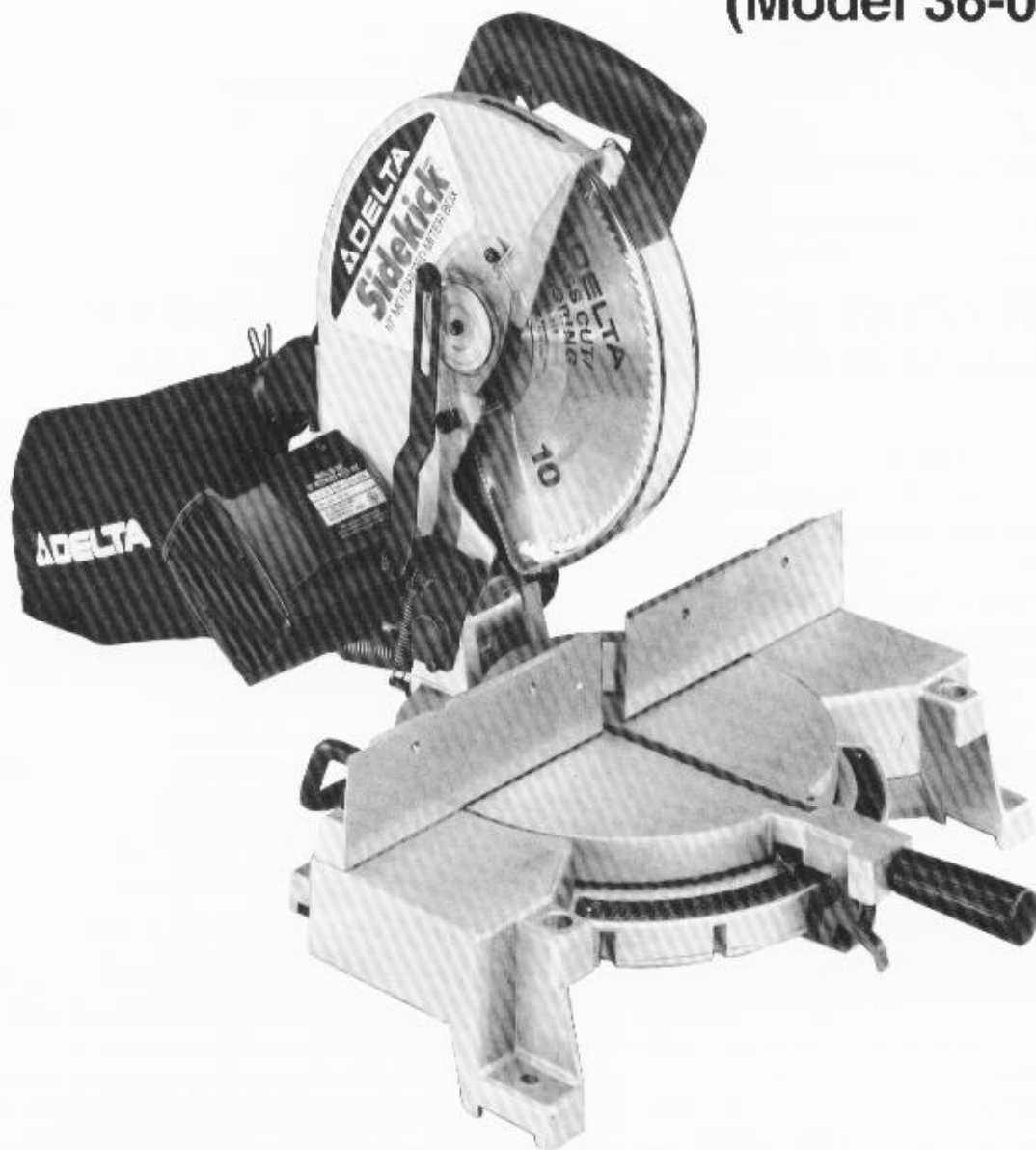

DATED 5-10-95

PART NO. 1340267

© Delta International Machinery Corp. 1995

 **DELTA**

TABLE OF CONTENTS

SAFETY RULES	3
ADDITIONAL SAFETY RULES FOR THE MITER BOX	4
UNPACKING	5
ASSEMBLY INSTRUCTIONS	5
Moving Cuttinghead To The Up Position	5
Rotating Table To 90 Degree Position	6
Assembling Blade	6
FASTENING MITER BOX TO SUPPORTING SURFACE	7
CONNECTING MITER BOX TO POWER SOURCE	
Power Connections	7
Motor Specifications	7
Extension Cords	8
Grounding Instructions	8
OPERATING CONTROLS	
Starting And Stopping Machine	9
Locking Switch In The "OFF" Position	9
Rotating Table For Miter Cutting	9
Pointer And Scale	10
Locking Cuttinghead In The Down Position	10
Rear Support/Carrying Handle	10
ADJUSTMENTS	
Adjusting Table Positive Stops	11
Adjusting Downward Travel Of Saw Blade	12
Changing Handle Position	12
Adjusting Pointer	13
Adjusting Fence 90 Degrees To Blade	13
TYPICAL OPERATIONS AND HELPFUL HINTS	13
Using Accessory 34-084 Dust Bag	14
Using Accessory 36-221 Work Clamp	14
General Cutting Operations	14
Cutting Aluminum	16
Cutting Bowed Material	16
Cutting Compound Miters	17
Cutting Crown Mouldings	18
Constructing Work Supports	21
MAINTENANCE	
Changing The Blade	21
Replacing Dust Deflector	22
Belt Replacement	23
Brush Inspection And Replacement	23
WARRANTY	24

SAFETY RULES

Woodworking can be dangerous if safe and proper operating procedures are not followed. As with all machinery, there are certain hazards involved with the operation of the product. Using the machine with respect and caution will considerably lessen the possibility of personal injury. However, if normal safety precautions are overlooked or ignored, personal injury to the operator may result. Safety equipment such as guards, push sticks, hold-downs, featherboards, goggles, dust masks and hearing protection can reduce your potential for injury. But even the best guard won't make up for poor judgment, carelessness or inattention. Always use common sense and exercise caution in the workshop. If a procedure feels dangerous, don't try it. Figure out an alternative procedure that feels safer. REMEMBER: Your personal safety is your responsibility.

This machine was designed for certain applications only. Delta Machinery strongly recommends that this machine not be modified and/or used for any application other than that for which it was designed. If you have any questions relative to a particular application, DO NOT use the machine until you have first contacted Delta to determine if it can or should be performed on the product.

DELTA INTERNATIONAL MACHINERY CORP.
MANAGER OF TECHNICAL SERVICES
246 ALPHA DRIVE
PITTSBURGH, PENNSYLVANIA 15238
(IN CANADA: 644 IMPERIAL ROAD, GUELPH, ONTARIO N1H 6M7)

WARNING: FAILURE TO FOLLOW THESE RULES MAY RESULT IN SERIOUS PERSONAL INJURY

- 1. FOR YOUR OWN SAFETY, READ INSTRUCTION MANUAL BEFORE OPERATING THE TOOL.** Learn the tool's application and limitations as well as the specific hazards peculiar to it.
- 2. KEEP GUARDS IN PLACE** and in working order.
- 3. ALWAYS WEAR EYE PROTECTION.**
- 4. GROUND ALL TOOLS.** If tool is equipped with three-prong plug, it should be plugged into a three-hole electrical receptacle. If an adapter is used to accommodate a two-prong receptacle, the adapter lug must be attached to a known ground. Never remove the third prong.
- 5. REMOVE ADJUSTING KEYS AND WRENCHES.** Form habit of checking to see that keys and adjusting wrenches are removed from tool before turning it "on."
- 6. KEEP WORK AREA CLEAN.** Cluttered areas and benches invite accidents.
- 7. DON'T USE IN DANGEROUS ENVIRONMENT.** Don't use power tools in damp or wet locations, or expose them to rain. Keep work area well-lighted.
- 8. KEEP CHILDREN AND VISITORS AWAY.** All children and visitors should be kept a safe distance from work area.
- 9. MAKE WORKSHOP CHILDPROOF** - with padlocks, master switches, or by removing starter keys.
- 10. DON'T FORCE TOOL.** It will do the job better and be safer at the rate for which it was designed.
- 11. USE RIGHT TOOL.** Don't force tool or attachment to do a job for which it was not designed.
- 12. WEAR PROPER APPAREL.** No loose clothing, gloves, neckties, rings, bracelets, or other jewelry to get caught in moving parts. Non-slip footwear is recommended. Wear protective hair covering to contain long hair.
- 13. ALWAYS USE SAFETY GLASSES.** Wear safety glasses (must comply with ANSI Z87.1). Everyday eyeglasses only have impact resistant lenses; they are not safety glasses. Also use face or dust mask if cutting operation is dusty.
- 14. SECURE WORK.** Use clamps or a vise to hold work when practical. It's safer than using your hand and frees both hands to operate tool.
- 15. DON'T OVERREACH.** Keep proper footing and balance at all times.
- 16. MAINTAIN TOOLS IN TOP CONDITION.** Keep tools sharp and clean for best and safest performance. Follow instructions for lubricating and changing accessories.
- 17. DISCONNECT TOOLS** before servicing and when changing accessories such as blades, bits, cutters, etc.
- 18. USE RECOMMENDED ACCESSORIES.** The use of improper accessories may cause hazards or risk of injury to persons.
- 19. REDUCE THE RISK OF UNINTENTIONAL STARTING.** Make sure switch is in "OFF" position before plugging in power cord.
- 20. NEVER STAND ON TOOL.** Serious injury could occur if the tool is tipped or if the cutting tool is accidentally contacted.
- 21. CHECK DAMAGED PARTS.** Before further use of the tool, a guard or other part that is damaged should be carefully checked to ensure that it will operate properly and perform its intended function - check for alignment of moving parts, binding of moving parts, breakage of parts, mounting, and any other conditions that may affect its operation. A guard or other part that is damaged should be properly repaired or replaced.
- 22. DIRECTION OF FEED.** Feed work into a blade or cutter against the direction of rotation of the blade or cutter only.
- 23. NEVER LEAVE TOOL RUNNING UNATTENDED. TURN POWER OFF.** Don't leave tool until it comes to a complete stop.
- 24. DRUGS, ALCOHOL, MEDICATION.** Do not operate tool while under the influence of drugs, alcohol or any medication.
- 25. MAKE SURE TOOL IS DISCONNECTED FROM POWER SUPPLY** while motor is being mounted, connected or reconnected.
- 26. WARNING:** The dust generated by certain woods and wood products can be injurious to your health. Always operate machinery in well ventilated areas and provide for proper dust removal. Use wood dust collection systems whenever possible.

ADDITIONAL SAFETY RULES FOR THE MITER BOX

1. **WARNING: USE ONLY CROSS-CUTTING SAW BLADES. WHEN USING CARBIDE TIPPED BLADES, MAKE SURE THEY HAVE A NEGATIVE HOOK ANGLE. DO NOT USE BLADES WITH DEEP GULLETS AS THEY CAN DEFLECT AND CONTACT GUARD.**
2. **WARNING:** Do not operate the miter box until it is completely assembled and installed according to the instructions.
3. **IF YOU ARE NOT** thoroughly familiar with the operation of miter boxes, obtain advice from your supervisor, instructor or other qualified person.
4. **ALWAYS** hold the work firmly against the fence and table. **DO NOT** perform any operation freehand.
5. **WARNING:** Keep hands out of path of saw blade. If the workpiece you are cutting would cause your hand to be within 4 inches of the saw blade, the workpiece should be clamped in place before making cut.
6. **BE SURE** blade is sharp, runs freely and is free of vibration.
7. **ALLOW** the motor to come up to full speed before starting cut.
8. **KEEP** motor air slots clean and free of chips.
9. **ALWAYS MAKE SURE** the table clamp handle is tight before cutting, even if the table is positioned in one of the positive stops.
10. **BE SURE** blade and flanges are clean and that arbor screw is tightened securely.
11. **USE** only blade flanges specified for your saw.
12. **NEVER** use blades larger or smaller in diameter than recommended.
13. **NEVER** apply lubricants to the blade when it is running.
14. **ALWAYS** check the blade for cracks or damage before operation. Replace cracked or damaged blade immediately.
15. **NEVER** use blades recommended for operation at less than 6000 RPM.
16. **USE** the blade guard at all times.
17. **ALWAYS** keep the lower blade guard in place.
18. **NEVER** reach around saw blade.
19. **MAKE SURE** blade is not contacting workpiece before switch is turned on.
20. **NEVER** lock the switch in the "ON" position.
21. **TURN OFF** tool and wait for blade to stop before moving workpiece or changing setting.
22. **MAKE SURE** blade has come to a complete stop before removing or securing workpiece, changing workpiece angle or changing the angle of the blade.
23. **NEVER** cut ferrous metals or masonry.
24. **NEVER** recut small pieces.
25. **PROVIDE** adequate support to the sides of the saw table for long workpieces.
26. **NEVER** use the miter box in an area with flammable liquids or gases.
27. **NEVER** use solvents to clean plastic parts. Solvents could possibly dissolve or otherwise damage the material. Only a soft damp cloth should be used to clean plastic parts.
28. **SHUT OFF** power before servicing or adjusting tool.
29. **DISCONNECT** power before changing blades or servicing.
30. **THE USE** of attachments and accessories not recommended by Delta may result in the risk of injuries.
31. **SHOULD** any part of your miter box be missing, damaged or fail in any way, or any electrical component fail to perform properly, shut off switch and remove plug from power supply outlet. Replace missing, damaged or failed parts before resuming operation.
32. **ADDITIONAL INFORMATION** regarding the safe and proper operation of this product is available from the National Safety Council, 1121 Spring Lake Drive, Itasca, IL 60143-3201, in the Accident Prevention Manual for Industrial Operation and also in the Safety Data Sheets provided by the NSC. Please also refer to the American National Standard Institute ANSI O1.1 Safety Requirements for Woodworking Machinery and the U.S. Department of Labor OSHA 1910.213 Regulations.
33. **SAVE THESE INSTRUCTIONS.** Refer to them often and use them to instruct others.

UNPACKING

1. Remove the miter box and all loose items from the carton. **IMPORTANT: DO NOT LIFT THE MITER BOX BY THE SWITCH HANDLE OR TABLE CONTROL HANDLE AS THIS MAY CAUSE MISALIGNMENT. ALWAYS LIFT THE MACHINE BY THE BASE OR CARRYING HANDLE.** Fig. 2, illustrates the machine after it has been removed from the carton.

WARNING: FOR YOUR OWN SAFETY, DO NOT CONNECT THE MITER BOX TO THE POWER SOURCE UNTIL THE MACHINE IS COMPLETELY ASSEMBLED AND YOU HAVE READ AND UNDERSTOOD THE ENTIRE OWNERS MANUAL.



Fig. 2

ASSEMBLY INSTRUCTIONS

WARNING: MAKE CERTAIN THE POWER CORD IS DISCONNECTED FROM THE POWER SOURCE DURING THE COMPLETE ASSEMBLY PROCEDURE.

MOVING CUTTINGHEAD TO THE UP POSITION

1. Push down on cuttinghead handle and rotate lever (A) Fig. 3, to the rear.

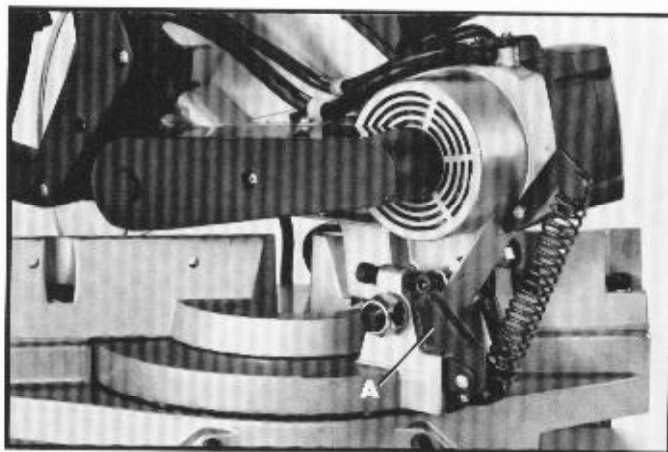

Fig. 3

2. The cuttinghead (B) can then be moved to the up position, as shown in Fig. 4.

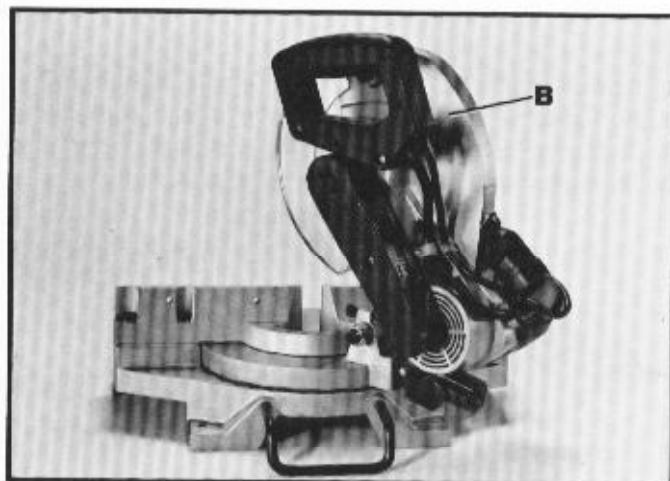

Fig. 4

ROTATING TABLE TO 90 DEGREE POSITION

1. Loosen handle (A) Fig. 5, one turn, and pull out plunger trigger (B) as shown. Rotate table to the left until plunger engages with the 90 degree stop (C). Then tighten handle (A).

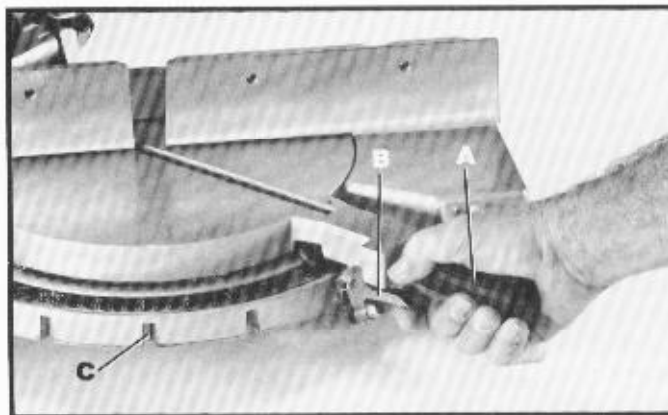

Fig. 5

ASSEMBLING BLADE

1. Remove screw (A) Fig. 6.



Fig. 6

2. Rotate arbor cover (B) Fig. 7, and lower guard (K) to the rear, exposing saw arbor (C), as shown.

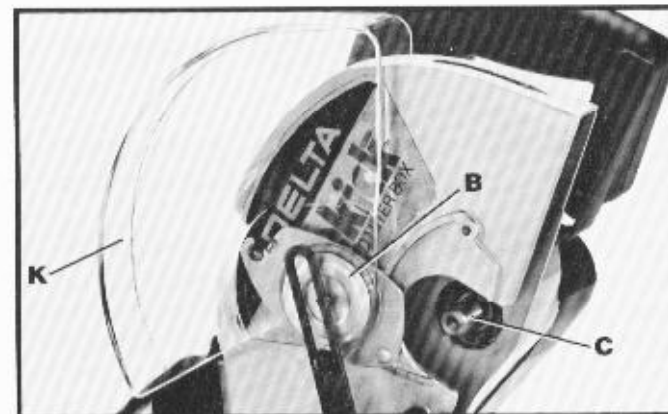

Fig. 7

3. Locate inside blade flange (D) Fig. 8, and assemble flange (D) to saw arbor (C) as shown. Make sure inside blade flange (D) is on the arbor as far as it will go and that the flange is clean and free of any foreign substance.

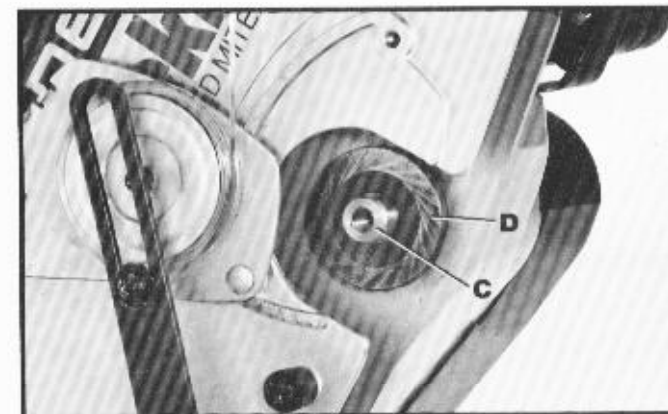

Fig. 8

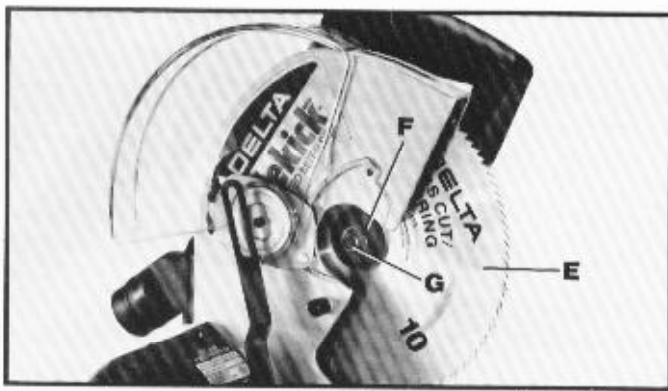

Fig. 9

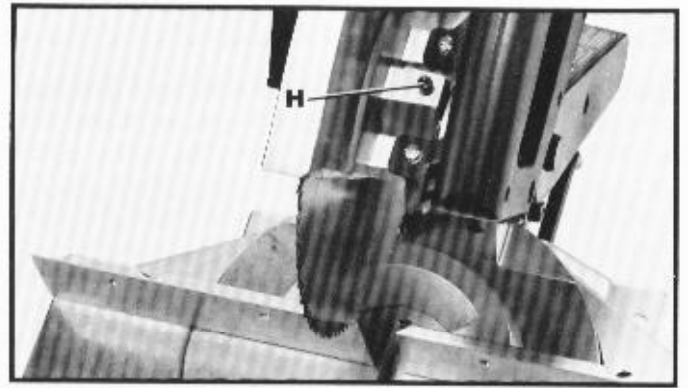

Fig. 10

4. Assemble saw blade (E) Fig. 9, to the saw arbor. **MAKE CERTAIN TEETH OF SAW BLADE (E) ARE POINTING DOWN AT THE FRONT, AS SHOWN.** Assemble outside blade flange (F) to saw arbor, making sure flats on outside blade flange (F) are engaged with flats on arbor shaft. Also make sure outside blade flange (F) is clean and free of any foreign substance.

5. Thread arbor screw (G) Fig. 9, into saw arbor by turning screw (G) counterclockwise as far as possible by hand. Then tighten arbor screw (G) Fig. 9, with wrench supplied while at the same time pressing in on arbor lock (H) Fig. 10, to keep arbor from turning.

6. Rotate arbor cover (B) Fig. 11, and lower guard (K) to the front and replace screw (A) that was removed in STEP 1.



Fig. 11

FASTENING MITER BOX TO SUPPORTING SURFACE

IF DURING OPERATION THERE IS ANY TENDENCY FOR THE MITER BOX TO TIP OVER, SLIDE OR WALK ON THE SUPPORTING SURFACE, THE MITER BOX MUST BE SECURED TO THE SUPPORTING SURFACE USING THE FOUR HOLES, TWO OF WHICH ARE SHOWN AT (A) FIG. 12.

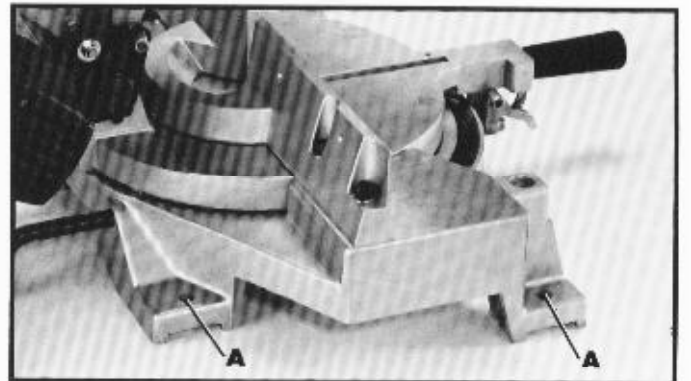

Fig. 12

CONNECTING MITER BOX TO POWER SOURCE

POWER CONNECTIONS

A separate electrical circuit should be used for your tools. This circuit should not be less than #12 wire and should be protected with a 20 Amp fuse. Have a certified electrician replace or repair a worn cord immediately. Before connecting the motor to a power line, make sure the switch is in the "OFF" position and be sure that the electric current is of the same characteristics as stamped on the motor nameplate. Running on low voltage will damage the motor.

WARNING: DO NOT EXPOSE THE TOOL TO RAIN OR OPERATE THE TOOL IN DAMP LOCATIONS.

MOTOR SPECIFICATIONS

Your miter saw is wired for 110-120 volt, 60 HZ alternating current. Before connecting the miter saw to the power source, make sure the switch is in the "OFF" position. The motor provides a no-load speed of 6000 RPM.

EXTENSION CORDS

Use proper extension cords. Make sure your extension cord is in good condition and is a 3-wire extension cord which has a 3-prong grounding type plug and a 3-hole receptacle which will accept the tool's plug. When using an extension cord, be sure to use one heavy enough to carry the current of the saw. An undersized cord will cause a drop in line voltage resulting in loss of power and overheating. Fig. 12A, shows the correct gage to use depending on cord length. If in doubt, use the next heavier gage. The smaller the gage number, the heavier the cord.

TOTAL LENGTH OF CORD IN FEET	GAGE OF EXTENSION CORD TO USE
0 - 25	14 AWG
26 - 50	12 AWG
Over 50	Not Recommended

Fig. 12A

GROUNDING INSTRUCTIONS

CAUTION: THIS TOOL MUST BE GROUNDED WHILE IN USE TO PROTECT THE OPERATOR FROM ELECTRIC SHOCK.

In the event of a malfunction or breakdown, grounding provides a path of least resistance for electric current to reduce the risk of electric shock. This tool is equipped with an electric cord having an equipment-grounding conductor and a grounding plug. The plug must be plugged into a matching outlet that is properly installed and grounded in accordance with all local codes and ordinances.

Do not modify the plug provided - if it will not fit the outlet, have the proper outlet installed by a qualified electrician.

Improper connection of the equipment-grounding conductor can result in risk of electric shock. The conductor with insulation having an outer surface that is green with or without yellow stripes is the equipment-grounding conductor. If repair or replacement of the electric cord or plug is necessary, do not connect the equipment grounding conductor to a live terminal.

Check with a qualified electrician or service personnel if the grounding instructions are not completely understood, or if in doubt as to whether the tool is properly grounded.

Use only 3-wire extension cords that have 3-prong grounding type plugs and 3-hole receptacles that accept the tool's plug, as shown in Fig. 13.

Repair or replace damaged or worn cord immediately.

This tool is intended for use on a circuit that has an outlet and a plug that looks like the one shown in Fig. 13. A temporary adapter, which looks like the adapter illustrated in Fig. 14, may be used to connect this plug to a 2-pole receptacle, as shown in Fig. 14, if a properly grounded outlet is not available. The temporary adapter should be used only until a properly grounded outlet can be installed by a qualified electrician. **THIS ADAPTER IS NOT APPLICABLE IN CANADA.** The green-colored rigid ear, lug, and the like, extending from the adapter must be connected to a permanent ground, such as a properly grounded outlet box, as shown in Fig. 14.

CAUTION: IN ALL CASES, MAKE CERTAIN THE RECEPTACLE IN QUESTION IS PROPERLY GROUNDED. IF YOU ARE NOT SURE HAVE A CERTIFIED ELECTRICIAN CHECK THE RECEPTACLE.

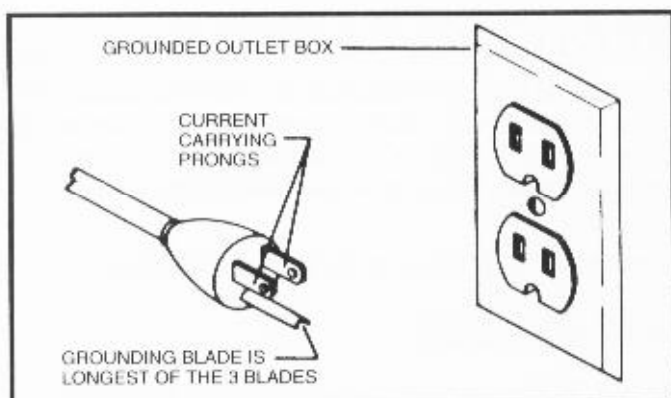

Fig. 13

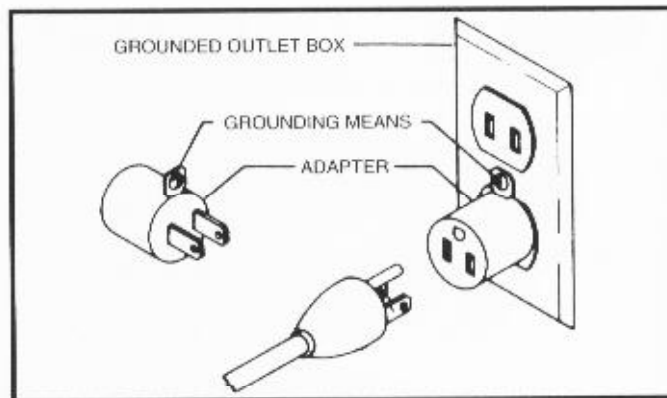

Fig. 14

OPERATING CONTROLS

STARTING AND STOPPING MACHINE

To start the machine, depress switch trigger (A) Fig. 15. To stop the machine, release the switch trigger.

This miter box is equipped with an automatic electric blade brake. As soon as the switch trigger (A) Fig. 15, is released, the electric brake is activated and stops the blade in seconds.

DANGER: A TURNING SAW BLADE CAN BE DANGEROUS. AFTER COMPLETING CUT, RELEASE SWITCH TRIGGER (A) FIG. 15, TO ACTIVATE BLADE BRAKE. KEEP SAW HEAD DOWN UNTIL BLADE HAS COME TO A COMPLETE STOP.

WARNING: THE TORQUE DEVELOPED DURING BRAKING MAY LOOSEN THE ARBOR SCREW. THE ARBOR SCREW SHOULD BE CHECKED PERIODICALLY AND TIGHTENED IF NECESSARY.

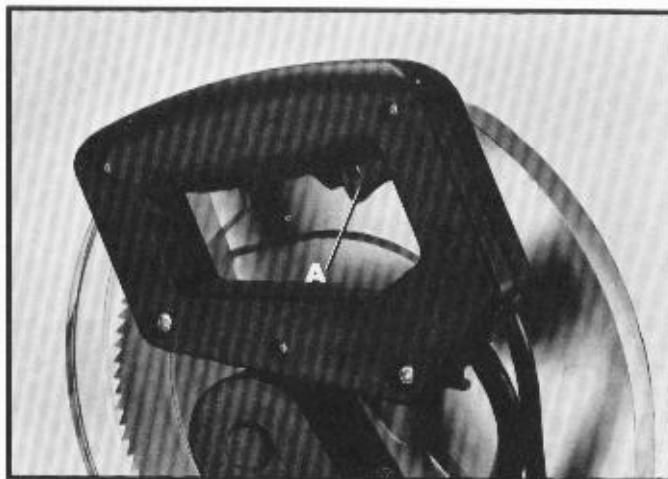

Fig. 15

LOCKING SWITCH IN THE "OFF" POSITION

IMPORTANT: We suggest that when the miter box is not in use, the switch be locked in the "OFF" position using a padlock (B), as shown in Fig. 16.



Fig. 16

ROTATING TABLE FOR MITER CUTTING

Your miter box will cut any angle from a straight 90 degree cut to 49 degrees right and left. Simply loosen lock handle (A) Fig. 17, pull out plunger trigger (B) and move the control arm to the desired angle. **THEN TIGHTEN LOCK HANDLE (A).**

The miter box is equipped with positive stops at the 0, 22-1/2 and 45 degree right and left positions. Simply loosen lock handle (A) Fig. 17, and move the control arm until the plunger engages into one of the positive stops, four of which are shown at (C). **THEN TIGHTEN LOCK HANDLE (A).** To disengage the positive stop, pull out plunger trigger (B).

IMPORTANT: ALWAYS TIGHTEN LOCK HANDLE (A) FIG. 17, BEFORE CUTTING.

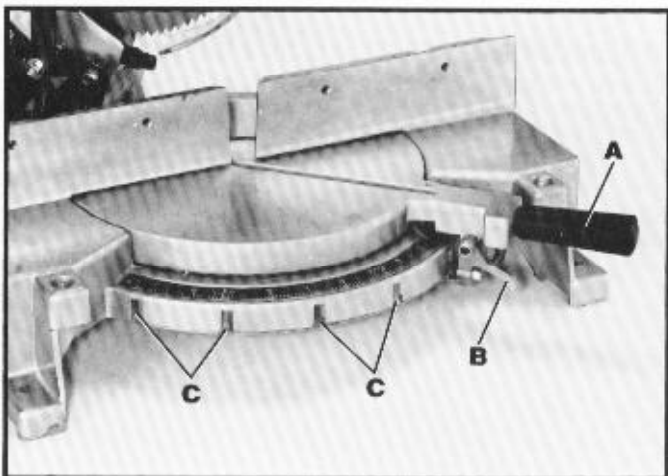

Fig. 17

POINTER AND SCALE

A pointer (A) Fig. 18, is supplied which indicates the actual angle of cut. Each line on the scale (B) represents 1/2 degree. In effect, when the pointer is moved from one line to the next on the scale, the angle of cut is changed by 1/2 degree.

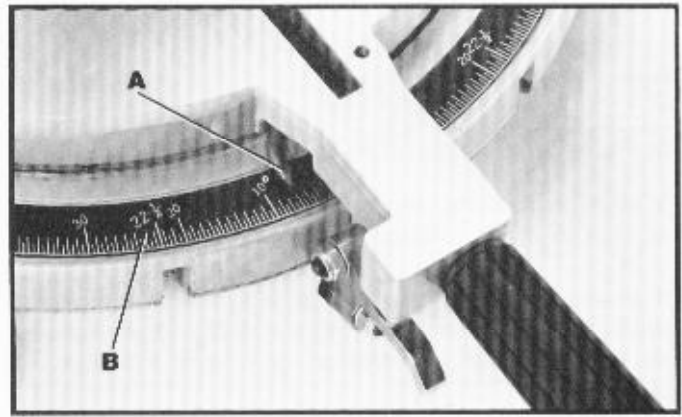

Fig. 18

LOCKING CUTTINGHEAD IN THE DOWN POSITION

When transporting the miter box, the cuttinghead should always be locked in the down position. This can be accomplished by lowering the cuttinghead and rotating lever (A) Fig. 19, forward, to the locked position, as shown. **NEVER CARRY THE MITER BOX BY THE SWITCH HANDLE OR TABLE CONTROL HANDLE AS THIS MAY CAUSE MISALIGNMENT. ALWAYS LIFT THE MACHINE BY THE BASE OR CARRYING HANDLE.**



Fig. 19

REAR SUPPORT/ CARRYING HANDLE

A rear support bar (A) Fig. 20, is provided to prevent the miter box from tipping to the rear when the cuttinghead is returned to the up position after a cut has been made. For maximum support, the bar (A) should be pulled out as far as possible.

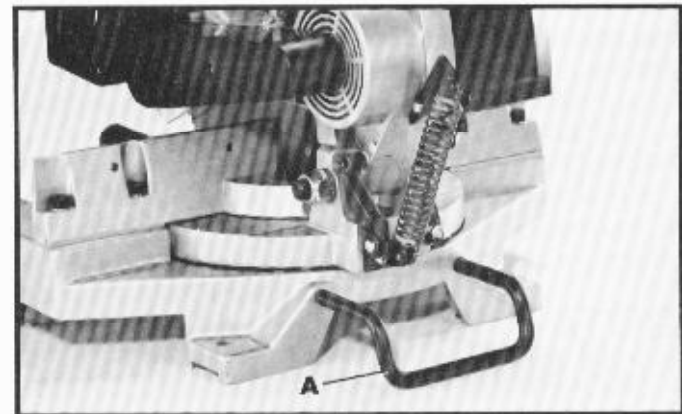

Fig. 20

The support bar (A) also acts as a carrying handle, as shown in Fig. 21, when transporting the saw.

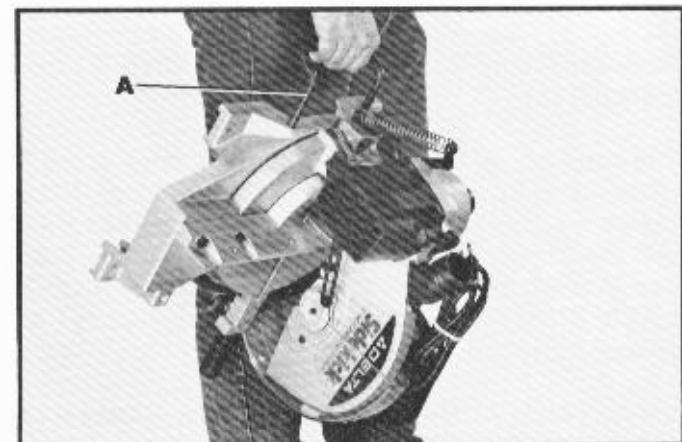

Fig. 21

ADJUSTMENTS

ADJUSTING TABLE POSITIVE STOPS

1. Move the table to the 90 degree straight cut-off position, making sure the plunger is engaged in the 90 degree positive stop and tighten the lock handle.

2. Make a cut on a piece of wood, as shown in Fig. 22.



Fig. 22

3. Using a square, check to see if the piece of wood was cut at 90 degrees, as shown in Fig. 23.

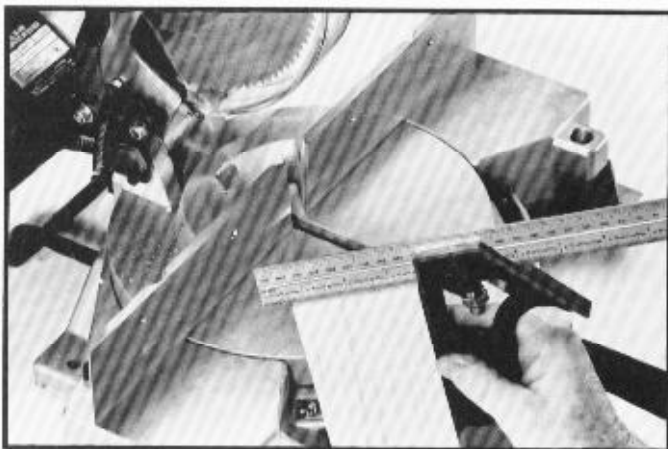

Fig. 23

4. If an adjustment is necessary, loosen the lock handle (A) Fig. 24, one turn. Then loosen locknut (B) and turn eccentric nut (C) right or left as necessary and tighten lock nut (B).

5. Make another test cut and if further adjustment is necessary, repeat the above instructions.

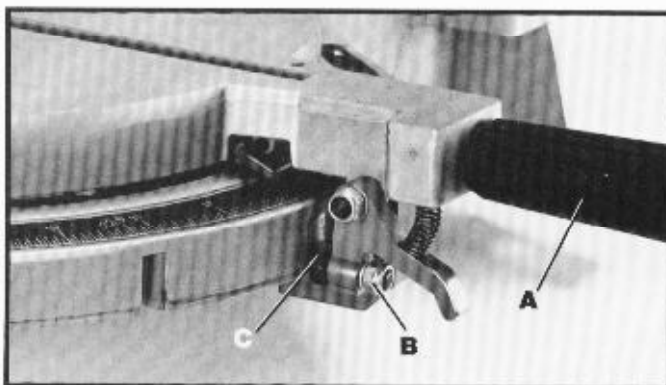

Fig. 24

6. When you are certain the cut is at 90 degrees, adjust pointer (D) Fig. 25, to point to the "0" mark on the scale, by loosening set screw (E).

7. Once the 90 degree positive stop is adjusted, the positive stops at 22-1/2 and 45 degrees right and left will also be adjusted.

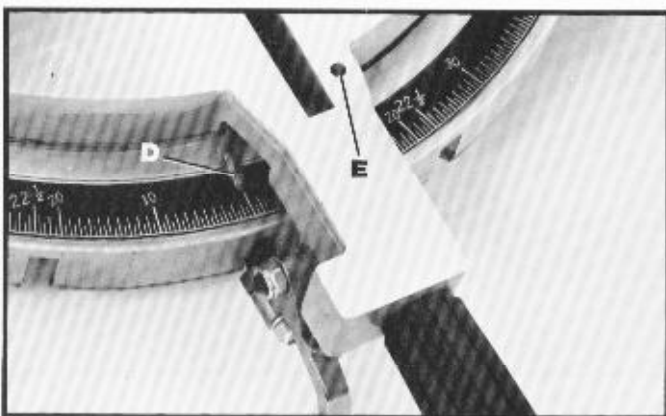

Fig. 25

ADJUSTING DOWNWARD TRAVEL OF SAW BLADE

The downward travel of the saw blade can be limited to prevent the saw blade from contacting any metal surfaces of the machine.

The depth of cut is controlled when end of stop screw (A) Fig. 26, contacts stop (B) when the cuttinghead is lowered. If an adjustment is necessary, loosen locknut (C) and turn stop screw (A). Then tighten locknut (C).

When making this adjustment, **DISCONNECT THE MACHINE FROM THE POWER SOURCE**, and lower the blade as far as possible. Rotate the blade by hand to make certain the teeth do not contact any metal surfaces.

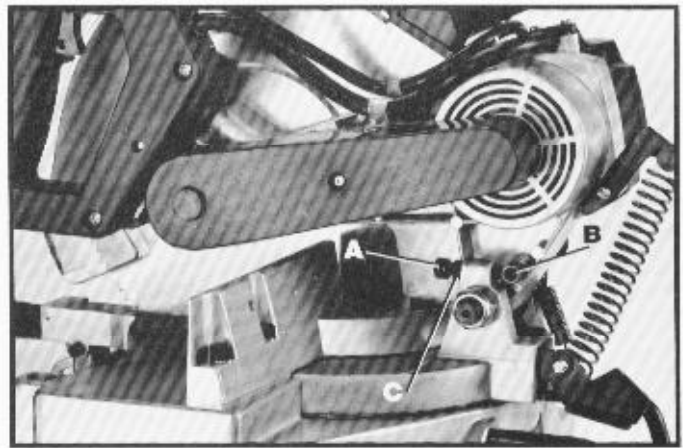

Fig. 26

CHANGING HANDLE POSITION

The cuttinghead handle can be repositioned for operator preference by loosening the two nuts (A) Fig. 27, and two screws (B) Fig. 28. Slide the handle to the desired position and tighten the two nuts and screws.

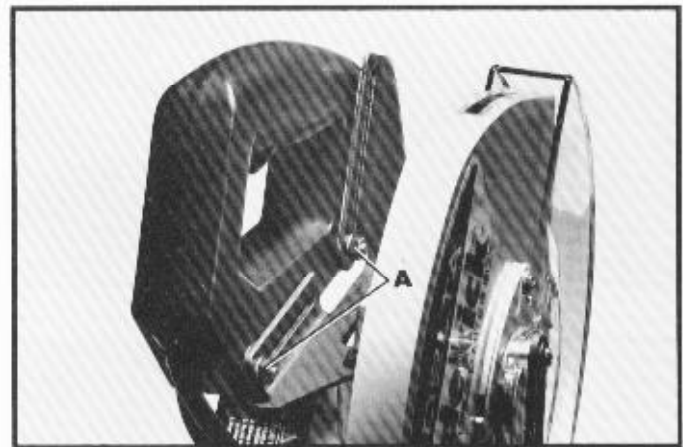

Fig. 27

Fig. 28 illustrates the handle (C) in the lowest position which is usually used when the miter box is being operated on a bench or work stand.

Fig. 29 illustrates the handle (C) in the highest position which is used when the miter box is being operated on the floor.

The handle can be positioned anywhere between the lowest and highest positions depending on operator preference.

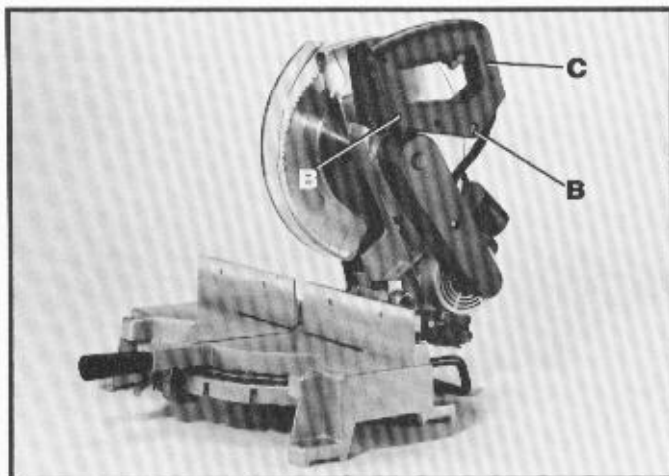

Fig. 28

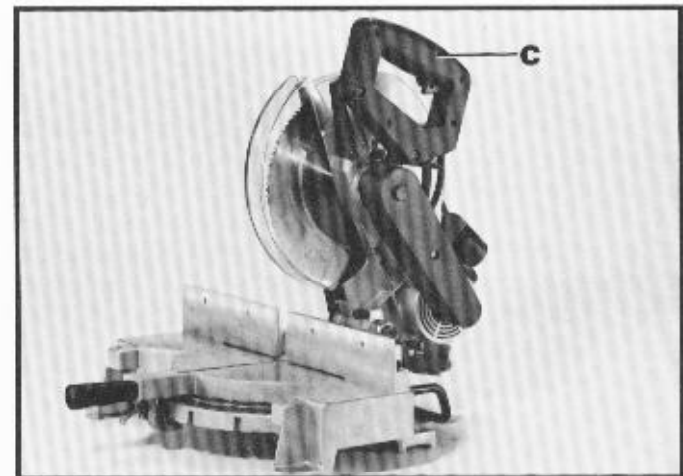

Fig. 29

ADJUSTING POINTER

If it becomes necessary to adjust the pointer (A) Fig. 30, simply loosen set screw (B), adjust the pointer accordingly, and tighten set screw (B).

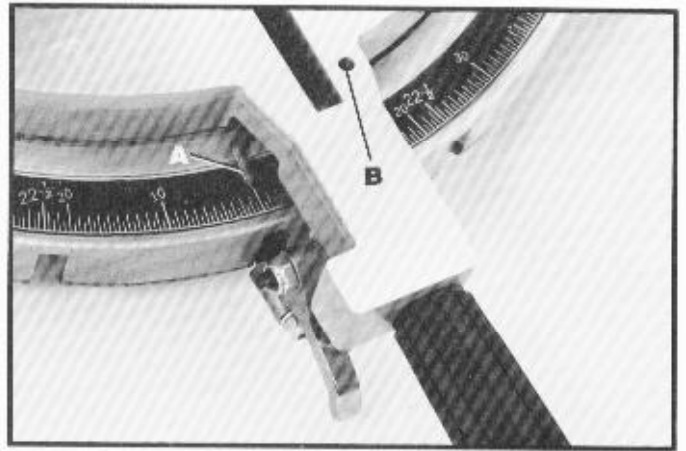

Fig. 30

ADJUSTING FENCE 90 DEGREES TO BLADE

If the fence (A) Fig. 31, is ever removed from the saw it should be adjusted so it is 90 degrees to the blade when it is replaced. Using a square, place one end of the square against the fence and the other end against the slot in the table, as shown in Fig. 31. Position the fence so it is 90 degrees to the table slot and tighten the four screws, two of which are shown at (B) Fig. 32. **IMPORTANT:** After the fence is positioned 90 degrees to the table slot, it may be necessary to adjust the positive stops by referring to the section **ADJUSTING TABLE POSITIVE STOPS**.

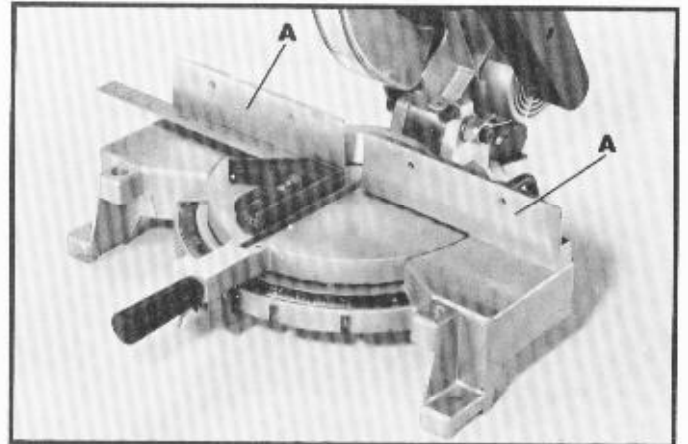

Fig. 31

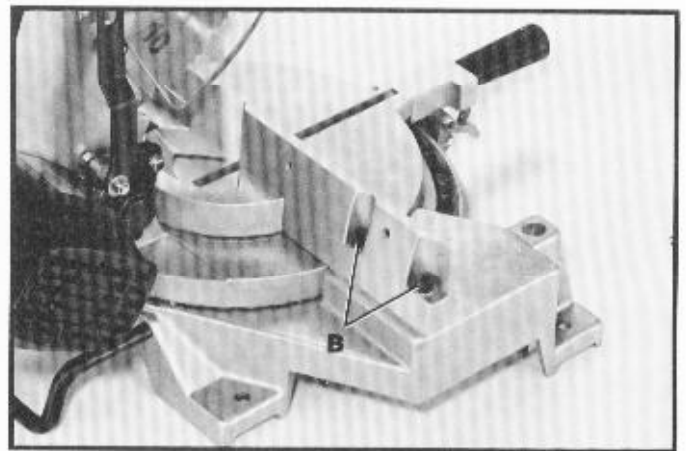

Fig. 32

TYPICAL OPERATIONS AND HELPFUL HINTS

1. Before cutting, make certain the table is set at the correct angle and firmly locked in place.
2. Before cutting, determine that the workpiece is the right size for the saw.
3. Place the workpiece on the table and hold it firmly against the fence.
4. For best results, cut at a slow, even cutting rate.
5. If the workpiece you are cutting causes your hand to be within 4 inches of the saw blade, the workpiece must be clamped to the fence before cutting.
6. Never attempt any freehand cutting (wood that is not held firmly against the fence and table).

USING ACCESSORY 34-084 DUST BAG

Available as an accessory for your miter box is the Catalog No. 34-084 Dust Bag, shown at (A) Fig. 33. The dust bag is assembled to the spout (B) making sure the wire ring (C) is engaged with the groove in the spout.

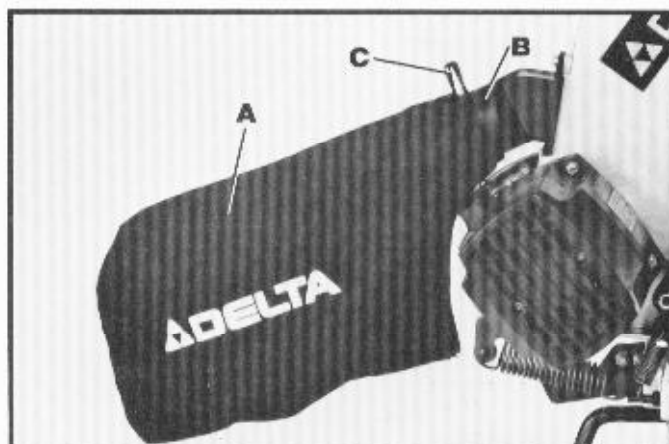

Fig. 33

USING ACCESSORY 36-221 WORK CLAMP

An ideal accessory for use with your miter box is the 36-221 work clamp, shown at (A) Fig. 34. Two holes are provided in the base of the miter box enabling you to use the clamp (A) on either the right or left hand side of the saw blade. **WARNING:** Keep hands out of path of saw blade. If the workpiece you are cutting would cause your hand to be within 4 inches of the saw blade, the workpiece should be clamped in place before making cut.

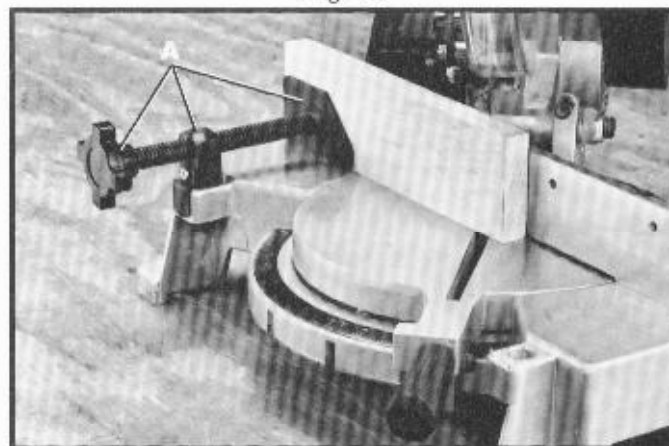

Fig. 34

GENERAL CUTTING OPERATIONS

1. Your miter box has the capacity to cut standard 2 x 4's laying flat or on edge, at the 45 degree right and left miter angles as shown in Figs. 35 and 36.



Fig. 35



Fig. 36

2. A standard 2 x 6 can easily be cut at the 90 degree straight cut-off position, as shown in Fig. 37.



Fig. 37

3. Cutting a standard 4 x 4 is easily accomplished with your miter box in one pass, as shown in Fig. 38.

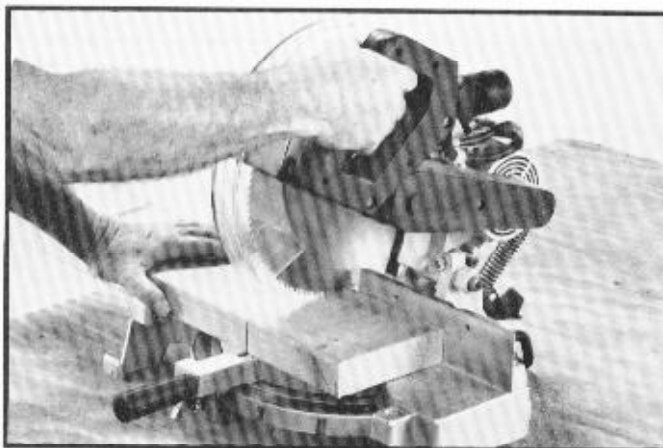

Fig. 38

4. Cutting various sizes of plastic pipe is an easy job with the miter box, as shown in Fig. 39.

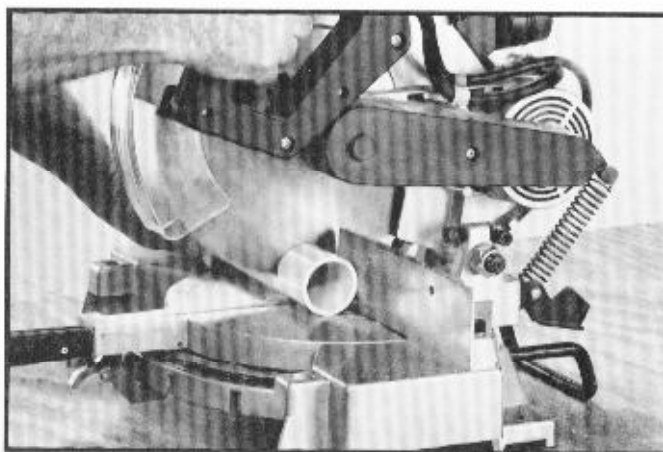

Fig. 39

CUTTING ALUMINUM

Aluminum extrusions such as used for making aluminum screens and storm windows can easily be cut with your miter box. When cutting aluminum extrusions, or other sections that can be cut with a saw blade and are within the capacity of the machine, position the material so the blade is cutting through the smallest cross-section, as shown in Fig. 40. The wrong way to cut aluminum angles is illustrated in Fig. 41. Be sure to apply a stick wax (similar to Johnson's stick wax #140) to the blade before cutting any aluminum stock. This stick wax is available at most industrial mill supply houses. The stick wax provides proper lubrication and keeps chips from adhering to the blade. **NEVER APPLY LUBRICANT TO THE BLADE WHILE THE MACHINE IS RUNNING.**

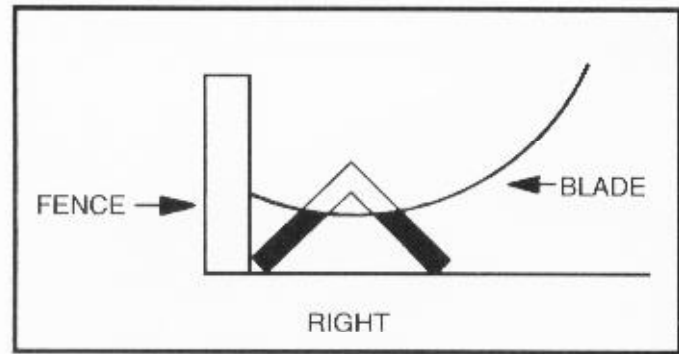

Fig. 40

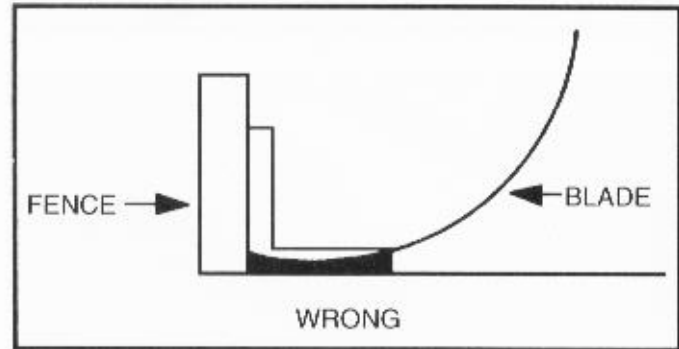

Fig. 41

CUTTING BOWED MATERIAL

When cutting flat pieces, first check to see if the material is bowed. If it is, make sure the material is positioned on the table as shown in Fig. 42.

If the material is positioned the wrong way, as shown in Fig. 43, the work piece will pinch the blade near the completion of the cut.

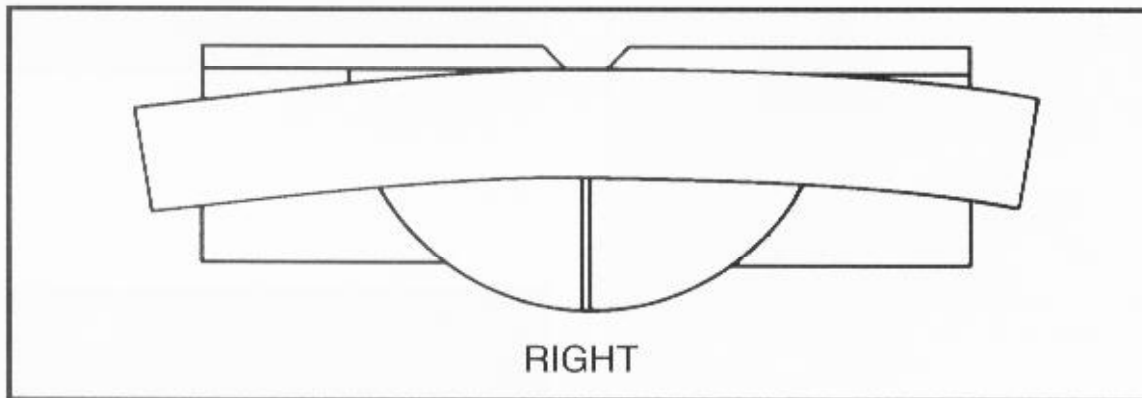

Fig. 42

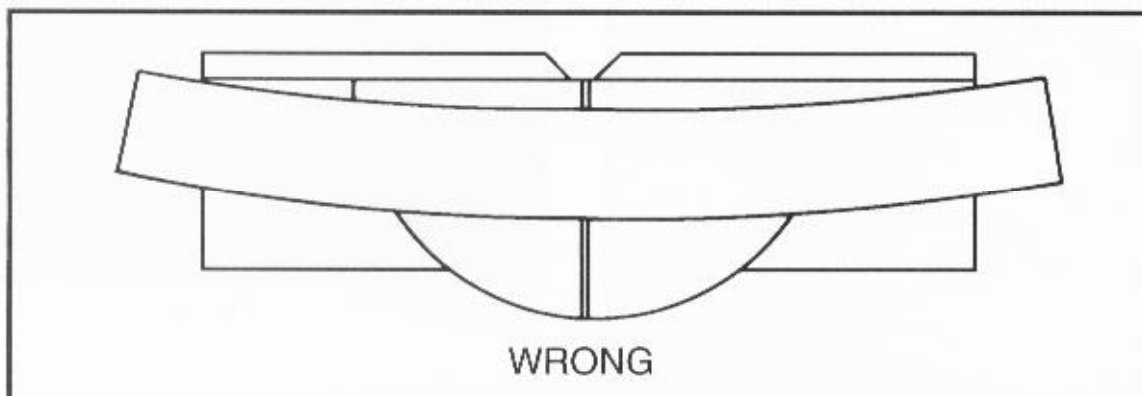

Fig. 43

CUTTING COMPOUND MITERS

1. Fig. 44, illustrates a filler block that can easily be constructed for use in cutting compound miters. Compound miters are used mostly for shadow box picture frames, etc. The face of the filler block is shown at 45 degrees to the fence and table. If a different work angle tilt is desired, simply vary the angle of the filler block face accordingly.

2. Although Fig. 44, illustrates the face of the filler block 3-5/8" wide, this dimension will vary depending on the material being cut.

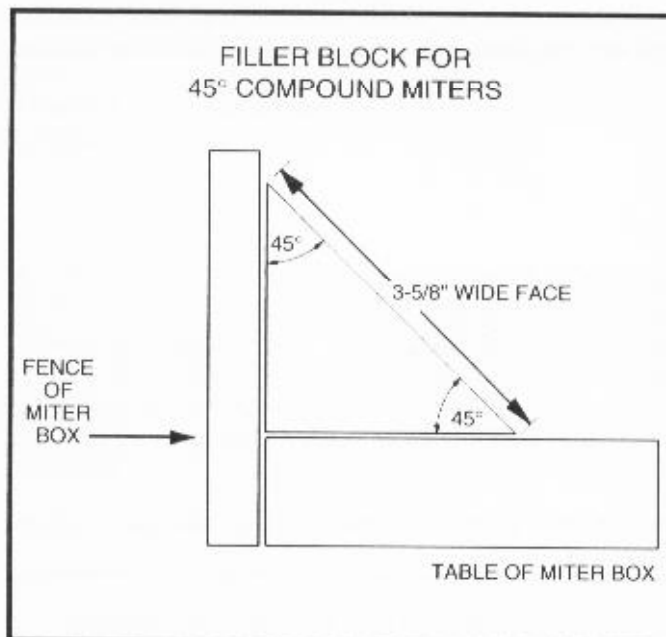

Fig. 44

3. Fig. 45, illustrates the filler blocks (A) for compound miters fastened to the miter box fence with the center portion of the filler block (45 degree right and left angle) removed after it was cut-out on the saw.

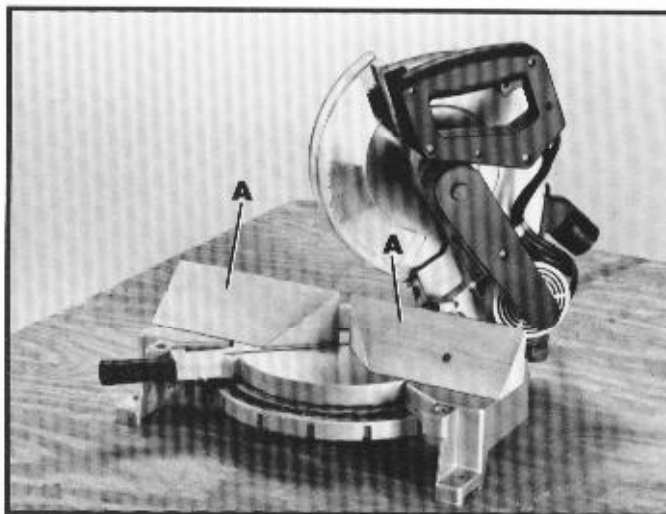

Fig. 45

4. The filler blocks are fastened to the fence using screws (B) through the two holes provided on each fence half, as shown in Fig. 46. This enables you to easily remove the filler blocks when not in use and quickly reassemble them to the fence when needed.

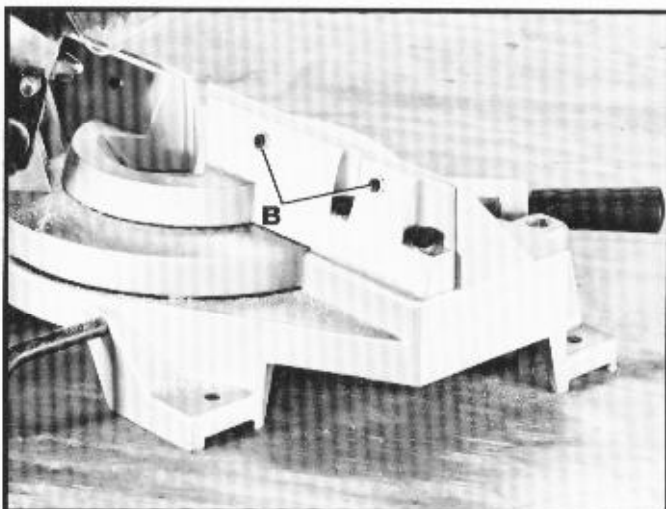

Fig. 46

5. Fig. 47, illustrates making a compound miter cut at the 45 degree right miter position. The 45 degree left compound miter cut, shown at (C) Fig. 47, was previously cut with the saw blade at the 45 degree left miter position.

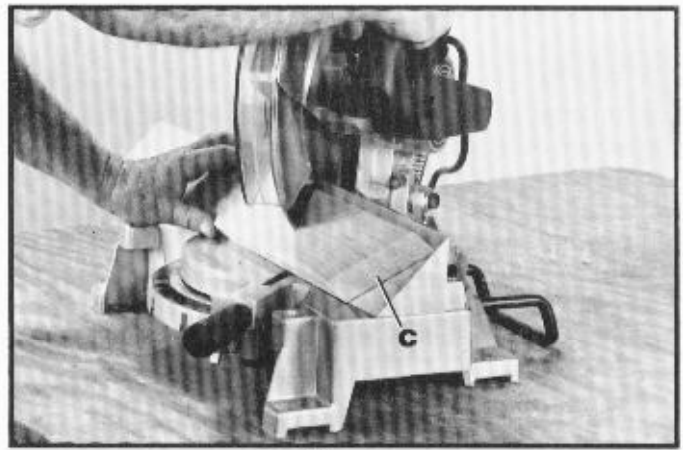

Fig. 47

6. The two compound miter cuts that were just made are shown in Fig. 48.

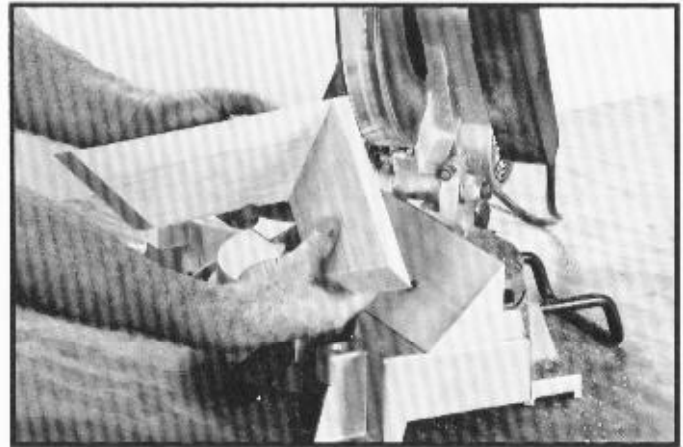

Fig. 48

CUTTING CROWN MOULDINGS

1. There are several methods that can be used to cut crown mouldings on the miter box. The method shown in Fig. 49, illustrates the contact surfaces (the surfaces that contact the wall and ceiling) of the crown moulding held firmly against the fence and table of the miter box. This method is acceptable when making a small number of cuts but would not be practical for a production application as it may be difficult to firmly hold the work in this position.

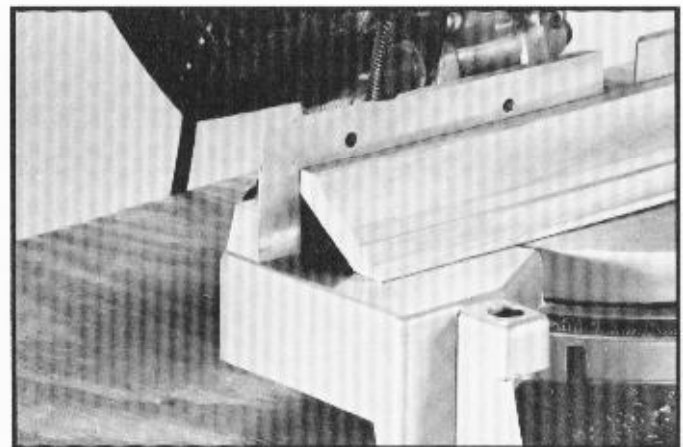

Fig. 49

2. When a large number of repetitive cuts of crown moulding are required we suggest the use of filler blocks, as shown in Fig. 50 through Fig. 53. The majority of crown mouldings have contact surfaces at 52 and 38 degrees to the rear surface of the moulding and these angles must be utilized when jointing the face of the filler block. For crown mouldings with different angles, appropriate filler blocks can be produced.

3. Fig. 50 and Fig. 51, illustrate the filler block fastened to the miter box fence with the face of the filler block extending outward from the top of the fence and down to the surface of the table. When the filler block is positioned in this manner, the crown moulding must be positioned on the table in the upside down position. This means that the surface of moulding that contacts the ceiling is against the table.

4. Fig. 52 and Fig. 53, illustrate the filler block fastened to the miter box fence with the face of the filler block extending inward toward the fence from the top to the bottom. When the filler block is positioned in this manner, the crown moulding is placed on the table in the same position as it would be when nailed between the ceiling and wall.

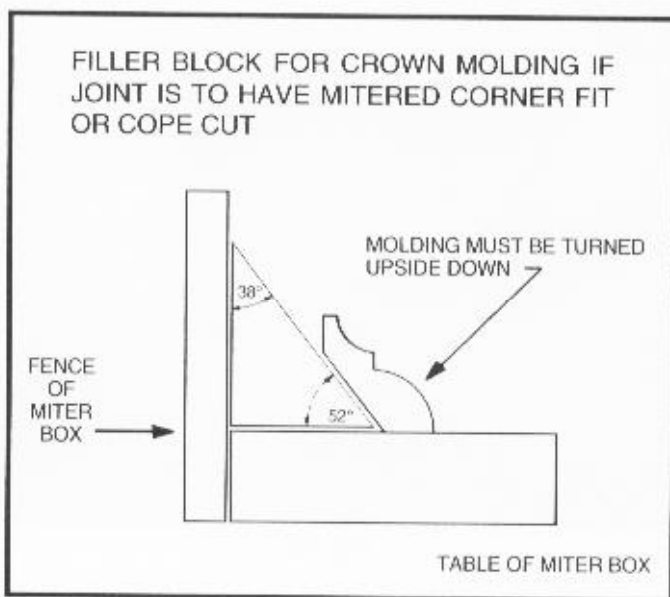

Fig. 50

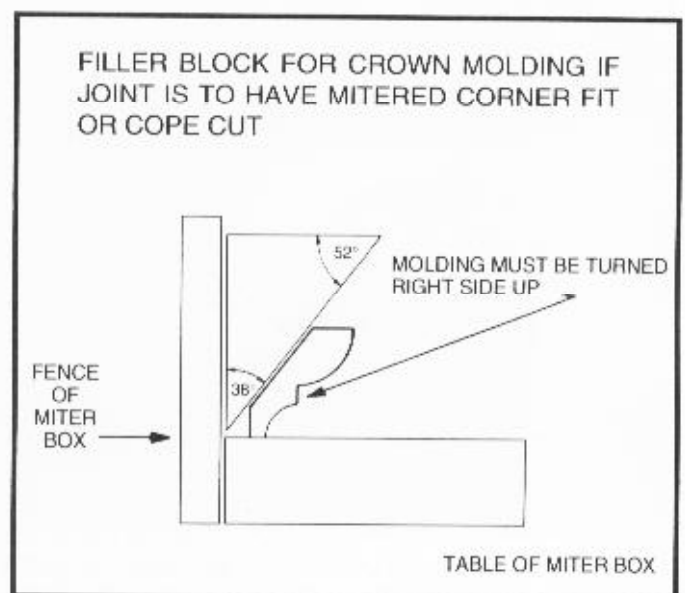

Fig. 52



Fig. 51

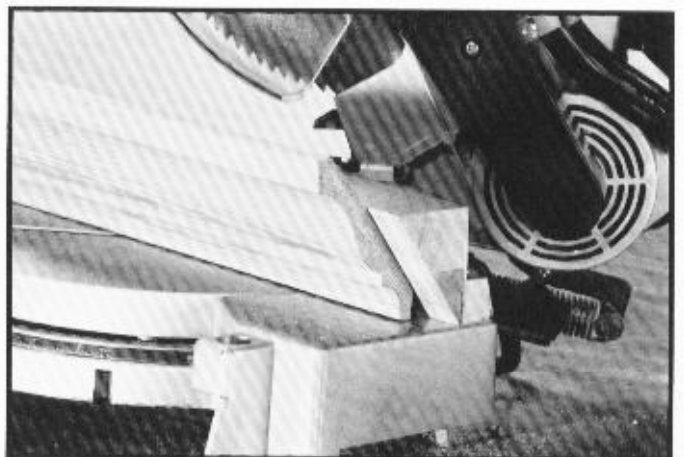

Fig. 53

5. Fasten the filler blocks to the fence using wood screws (A) through the two holes provided on each fence half, as shown in Fig. 54. This enables you to easily remove the filler blocks when not in use and quickly reassemble them to the fence when needed.

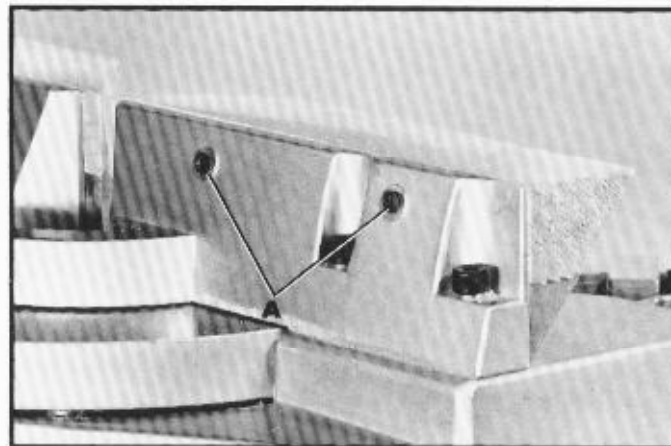

Fig. 54

6. Fig. 55, illustrates the miter box arm in the 45 degree right miter position and the filler blocks fastened to the fence so that the moulding will be in the same position as it would be when nailed between the ceiling and wall. When making this cut the moulding (B) on the left of the saw blade will be for an outside corner and the moulding (C) on the right of the saw blade will be for an inside corner. To cut the mating pieces for mouldings (B) and (C) Fig. 55, simply rotate the miter box arm to the 45 degree left miter position and make the cut, as shown in Fig. 56. In this case the moulding (D) on the left of the saw blade will be for an inside corner and the moulding (E) on the right of the saw blade will be for an outside corner.

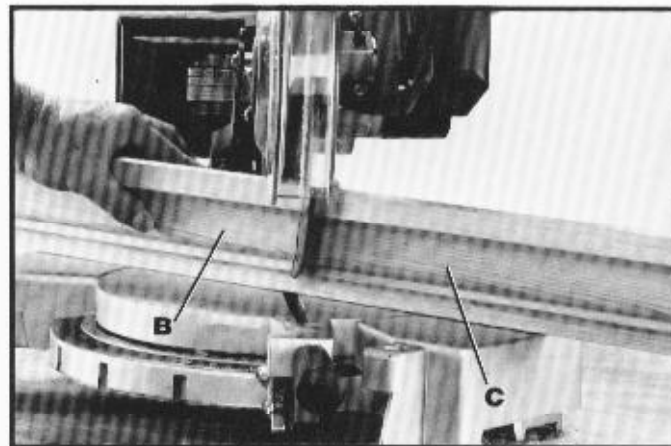

Fig. 55

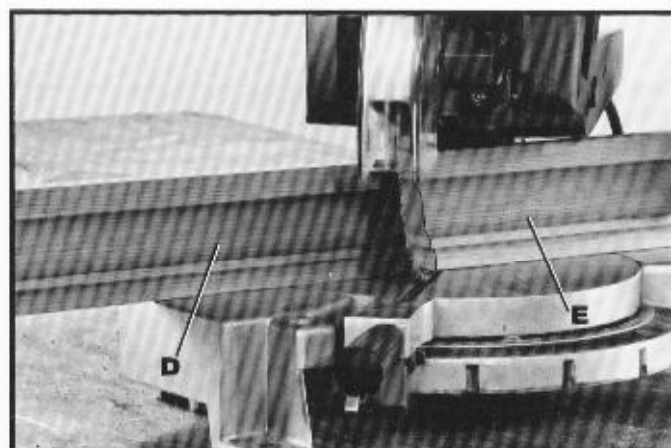

Fig. 56

CONSTRUCTING WORK SUPPORT EXTENSIONS

One of the unique features of your miter box is the ease with which you can construct work supports. Fig. 57, illustrates the miter box mounted to two standard 2 x 4's (A). Fasten the mounting legs of the miter box [two of which are shown at (B)] to the 2 x 4's using four screws through the four holes in the mounting legs. The length of the 2 x 4's (A) can vary depending on your preference. The distance from the top of the 2 x 4's (A) to the miter box table is 3-1/2 inches. This enables you to nail standard 2 x 4's (C) to the top of the 2 x 4's (A) , as shown. The top of the 2 x 4's (C) will then be the same height as the miter box table.

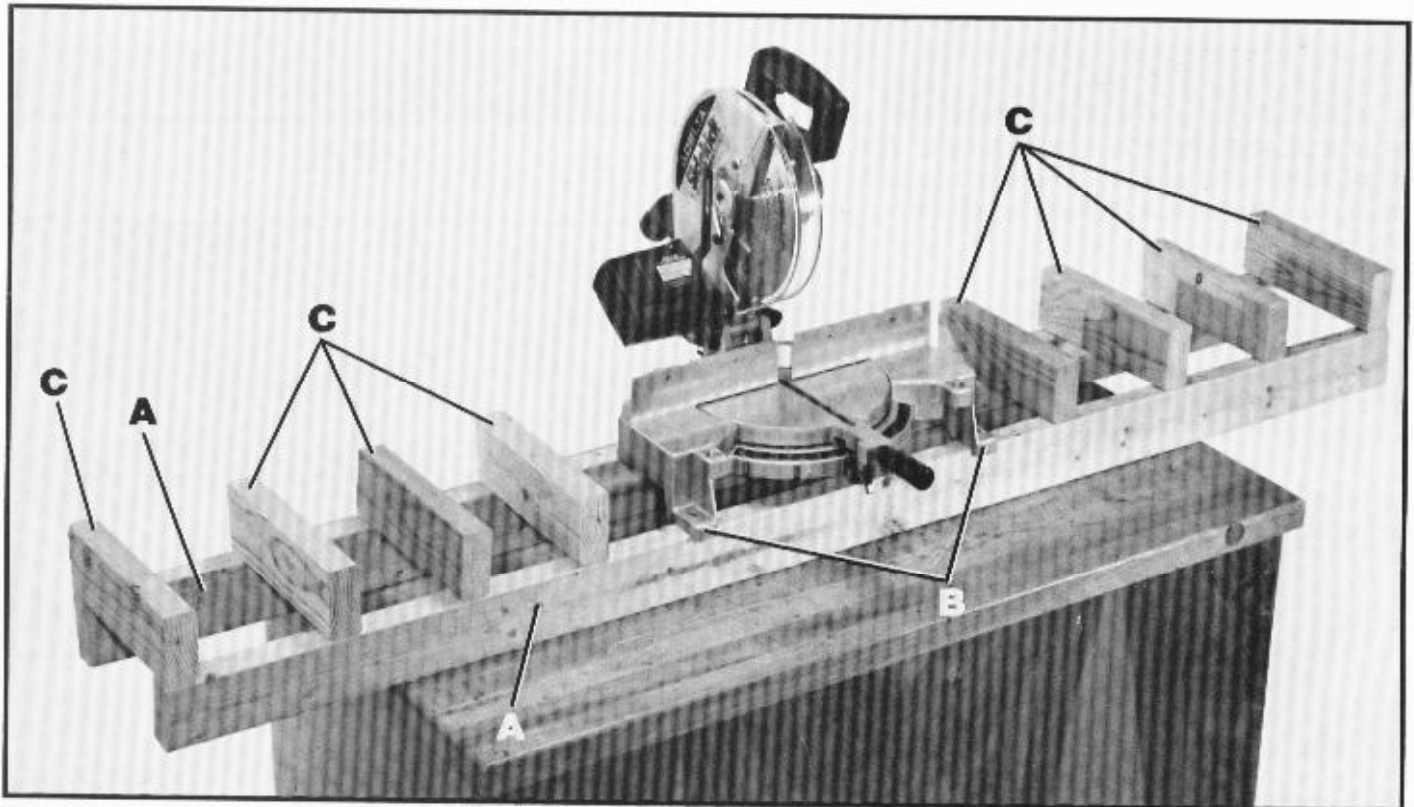

Fig. 57

MAINTENANCE

CHANGING THE BLADE

WARNING: USE ONLY CROSS-CUTTING SAW BLADES. WHEN USING CARBIDE TIPPED BLADES, MAKE SURE THEY HAVE A NEGATIVE HOOK ANGLE. DO NOT USE BLADES WITH DEEP GULLETS AS THEY CAN DEFLECT AND CONTACT GUARD. USE ONLY 10" DIAMETER SAW BLADES WHICH ARE RATED FOR 6000 RPM OR HIGHER AND HAVE 5/8" DIAMETER ARBOR HOLES.

1. DISCONNECT THE MACHINE FROM THE POWER SOURCE.

2. Remove screw (A) Fig. 58.



Fig. 58

3. Rotate arbor cover (B) Fig. 59, and lower guard (G) to the rear, exposing arbor screw (C), as shown.

4. Remove arbor screw (C) Fig. 59, by turning screw clockwise with wrench supplied while at the same time pressing in on arbor lock (D) Fig. 60, to keep the arbor from turning. Remove outside blade flange (E) Fig. 59, and saw blade (F). **DO NOT REMOVE INSIDE BLADE FLANGE.**

5. Assemble new saw blade **MAKING CERTAIN TEETH OF SAW BLADE ARE POINTING DOWN AT THE FRONT, AS SHOWN** and assemble outside blade flange (E) Fig. 59, making sure flats on outside blade flange are engaged with flats on arbor shaft.

6. Thread arbor screw (C) Fig. 59, into saw arbor by turning screw (C) counterclockwise as far as possible by hand. Then tighten arbor screw (C) with wrench supplied while at the same time pressing in on arbor lock (D) Fig. 60, to keep arbor from turning.

7. Rotate arbor cover (B) Fig. 59, and lower guard (G) to the front and replace screw (A) Fig. 58.

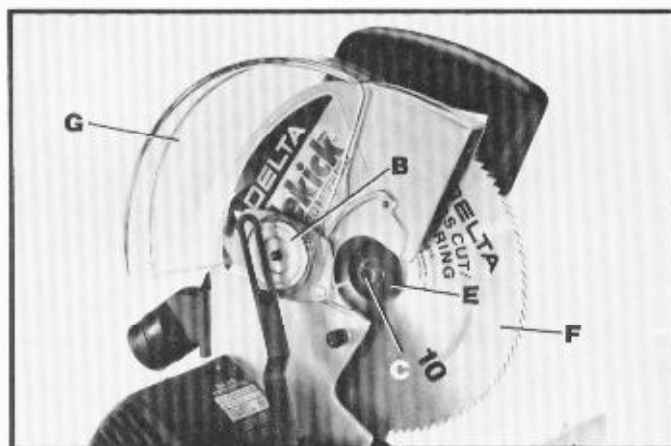

Fig. 59

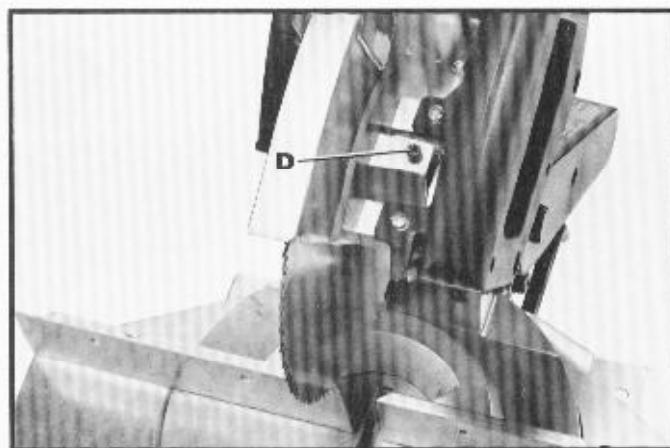

Fig. 60

REPLACING DUST DEFLECTOR

If it ever becomes necessary to replace the dust deflector (A) Fig. 61, **DISCONNECT THE MACHINE FROM THE POWER SOURCE** and remove the saw blade from the machine. Remove screw (B), replace deflector (A) and saw blade.

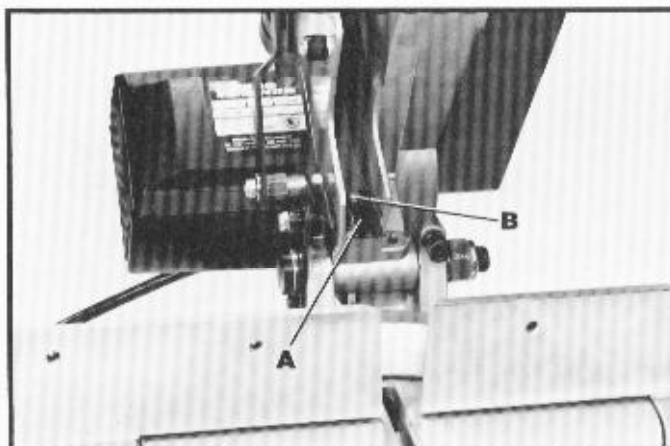

Fig. 61

BELT REPLACEMENT

If it ever becomes necessary to replace the belt on your miter box, proceed as follows:

1. **DISCONNECT THE MACHINE FROM THE POWER SOURCE.**

2. Remove screw (A) Fig. 62, and belt and pulley cover (B).

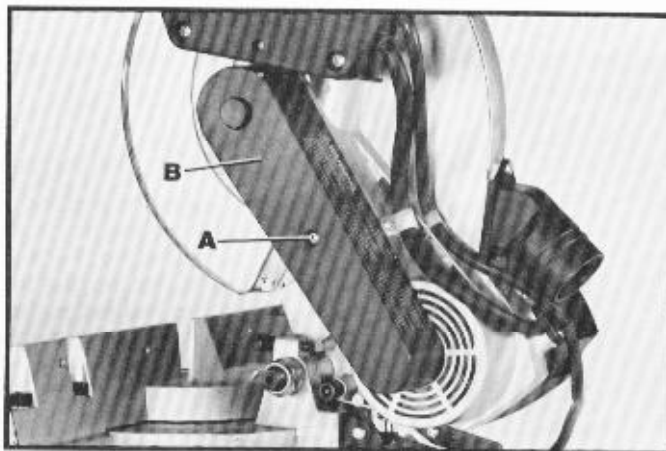

Fig. 62

3. Remove old belt and make certain the pulleys are clean.

4. Assemble new belt (C) Fig. 63, by engaging two grooves on the inside of the belt to two grooves on the motor pulley and arbor pulley while rotating the pulleys. Continue rotating pulleys (D) while pushing in on belt (C) until belt is fully engaged with the pulleys.

5. After the belt is engaged, replace belt and pulley cover and screw that was removed in **STEP 2**.

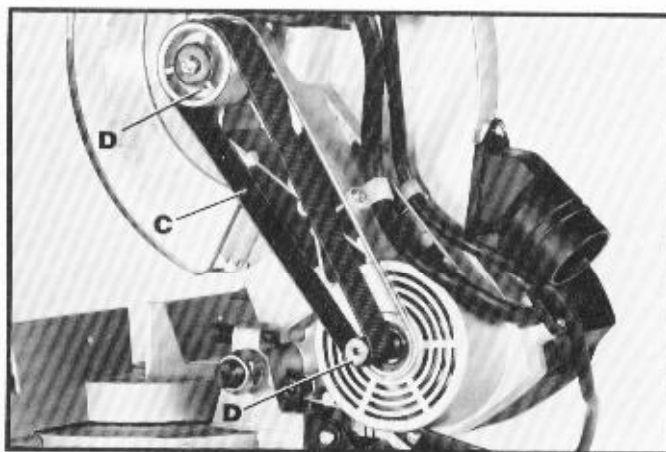

Fig. 63

BRUSH INSPECTION AND REPLACEMENT

CAUTION: BEFORE INSPECTING THE BRUSHES, DISCONNECT THE MACHINE FROM THE POWER SOURCE.

Brush life varies. It depends on the load on the motor. Check the brushes after the first 50 hours of use for a new machine or after a new set of brushes has been installed. After the first check, examine them after about 10 hours of use until such time that replacement is necessary. To inspect the brushes, proceed as follows:

1. Remove two screws (A) Fig. 64, and remove motor cover (B).

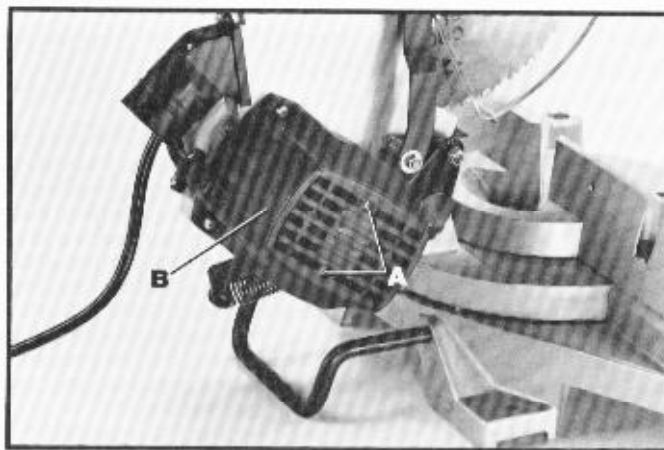

Fig. 64

2. The brushes are located in the two holders (C) Fig. 65. Remove spade type terminal connector (D) and pull out brush holders (C).

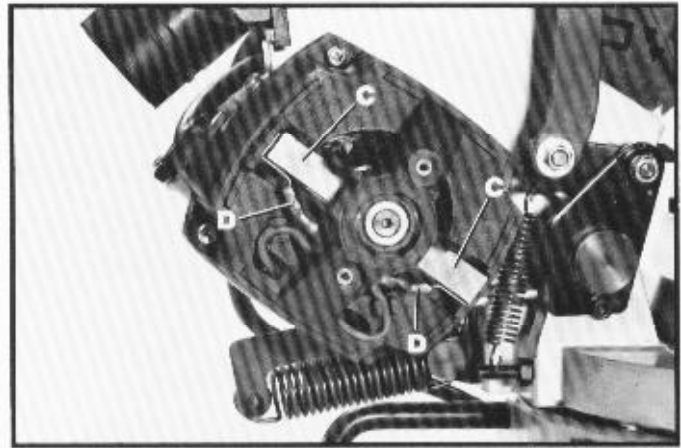

Fig. 65

3. Fig. 66, illustrates one of the brushes (E) removed from the holder (C). When the carbon on either brush (E) is worn to 3/16" in length or if either spring (F) or shunt wire is burned or damaged in any way, replace both brushes. If the brushes are found serviceable after removing, reinstall them in the same position as removed.

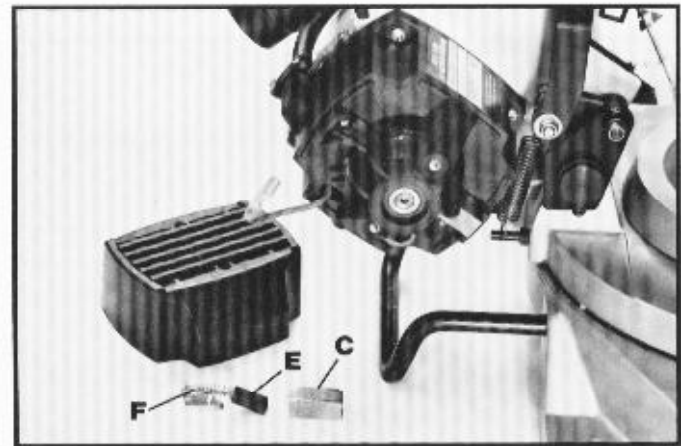

Fig. 66



Delta Building Trades and Home Shop Machinery Two Year Limited Warranty

Delta will repair or replace, at its expense and at its option, any Delta machine, machine part, or machine accessory which in normal use has proven to be defective in workmanship or material, provided that the customer returns the product prepaid to a Delta factory service center or authorized service station with proof of purchase of the product within two years and provides Delta with reasonable opportunity to verify the alleged defect by inspection. Delta may require that electric motors be returned prepaid to a motor manufacturer's authorized station for inspection and repair or replacement. Delta will not be responsible for any asserted defect which has resulted from normal wear, misuse, abuse or repair or alteration made or specifically authorized by anyone other than an authorized Delta service facility or representative. Under no circumstances will Delta be liable for incidental or consequential damages resulting from defective products. This warranty is Delta's sole warranty and sets forth the customer's exclusive remedy, with respect to defective products; all other warranties, express or implied, whether of merchantability, fitness for purpose, or otherwise, are expressly disclaimed by Delta.

Free Manuals Download Website

<http://myh66.com>

<http://usermanuals.us>

<http://www.somanuals.com>

<http://www.4manuals.cc>

<http://www.manual-lib.com>

<http://www.404manual.com>

<http://www.luxmanual.com>

<http://aubethermostatmanual.com>

Golf course search by state

<http://golfingnear.com>

Email search by domain

<http://emailbydomain.com>

Auto manuals search

<http://auto.somanuals.com>

TV manuals search

<http://tv.somanuals.com>