

# DENON

Control Dock for iPod®

# ASD-11R

---

**Owner's Manual**

**Manuel de l'Utilisateur**

**Manual del usuario**



iPod is a trademark of Apple Inc., registered in the U.S.

SAFETY PRECAUTIONS



**CAUTION**  
**RISK OF ELECTRIC SHOCK**  
**DO NOT OPEN**



**CAUTION:**

**TO REDUCE THE RISK OF ELECTRIC SHOCK, DO NOT REMOVE COVER (OR BACK). NO USER-SERVICEABLE PARTS INSIDE. REFER SERVICING TO QUALIFIED SERVICE PERSONNEL.**



The lightning flash with arrowhead symbol, within an equilateral triangle, is intended to alert the user to the presence of uninsulated "dangerous voltage" within the product's enclosure that may be of sufficient magnitude to constitute a risk of electric shock to persons.



The exclamation point within an equilateral triangle is intended to alert the user to the presence of important operating and maintenance (servicing) instructions in the literature accompanying the appliance.

**WARNING:**

**TO REDUCE THE RISK OF FIRE OR ELECTRIC SHOCK, DO NOT EXPOSE THIS APPLIANCE TO RAIN OR MOISTURE.**

# IMPOTANT SAFETY INSTRUCTIONS

1. Read these instructions.
2. Keep these instructions.
3. Heed all warnings.
4. Follow all instructions.
5. Do not use this apparatus near water.
6. Clean only with dry cloth.
7. Install in accordance with the manufacturer's instructions.
8. Do not install near any heat sources such as radiators, heat registers, stoves, or other apparatus (including amplifiers) that produce heat.
9. Protect the cord from being walked on or pinched particularly at plugs, convenience receptacles, and the point where they exit from the apparatus.
10. Only use attachments/accessories specified by the manufacturer.
11. Unplug this apparatus during lightning storms or when unused for long periods of time.
12. Refer all servicing to qualified service personnel. Servicing is required when the apparatus has been damaged in any way, such as power-supply cord or plug is damaged, liquid has been spilled or objects have fallen into the apparatus, the apparatus has been exposed to rain or moisture, does not operate normally, or has been dropped.

## FCC INFORMATION (For US customers)

### 1. PRODUCT

This product complies with Part 15 of the FCC Rules. Operation is subject to the following two conditions: (1) this product may not cause harmful interference, and (2) this product must accept any interference received, including interference that may cause undesired operation.

### 2. IMPORTANT NOTICE: DO NOT MODIFY THIS PRODUCT

This product, when installed as indicated in the instructions contained in this manual, meets FCC requirements. Modification not expressly approved by DENON may void your authority, granted by the FCC, to use the product.

### 3. NOTE

This product has been tested and found to comply with the limits for a Class B digital device, pursuant to Part 15 of the FCC Rules. These limits are designed to provide reasonable protection against harmful interference in a residential installation.

This product generates, uses and can radiate radio frequency energy and, if not installed and used in accordance with the instructions, may cause harmful interference to radio communications. However, there is no guarantee that interference will not occur in a particular installation. If this product does cause harmful interference to radio or television reception, which can be determined by turning the product OFF and ON, the user is encouraged to try to correct the interference by one or more of the following measures:

- Reorient or relocate the receiving antenna.
- Increase the separation between the equipment and receiver.
- Connect the product into an outlet on a circuit different from that to which the receiver is connected.
- Consult the local retailer authorized to distribute this type of product or an experienced radio/TV technician for help.

This Class B digital apparatus complies with Canadian ICES-003.  
Cet appareil numérique de la classe B est conforme à la norme NMB-003 du Canada.

## For Europe model only

### • DECLARATION OF CONFORMITY

We declare under our sole responsibility that this product, to which this declaration relates, is in conformity with the following standards: EN60950, EN55022, EN55024, EN61000-3-2 and EN61000-3-3.

Following the provisions of 2006/95/EC and 2004/108/EC Directive.

### • DECLARATION DE CONFORMITE

Nous déclarons sous notre seule responsabilité que l'appareil, auquel se réfère cette déclaration, est conforme aux standards suivants:

EN60950, EN55022, EN55024, EN61000-3-2 et EN61000-3-3.

D'après les dispositions de la Directive 2006/95/EC et 2004/108/EC.

### • DECLARACIÓN DE CONFORMIDAD

Declaramos bajo nuestra exclusiva responsabilidad que este producto al que hace referencia esta declaración, está conforme con los siguientes estándares:

EN60950, EN55022, EN55024, EN61000-3-2 y EN61000-3-3.

Siguiendo las provisiones de las Directivas 2006/95/EC y 2004/108/EC.

DENON EUROPE

Division of D&M Germany GmbH

An der Landwehr 19, Nettetal,

D-41334 Germany

### CAUTION:

To completely disconnect this product from the mains, disconnect the plug from the wall socket outlet.

The mains plug is used to completely interrupt the power supply to the unit and must be within easy access by the user.

### PRECAUTION:

Pour déconnecter complètement ce produit du courant secteur, débranchez la prise de la prise murale.

La prise secteur est utilisée pour couper complètement l'alimentation de l'appareil et l'utilisateur doit pouvoir y accéder facilement.

### PRECAUCIÓN:

Para desconectar completamente este producto de la alimentación eléctrica, desconecte el enchufe del enchufe de la pared.

El enchufe de la alimentación eléctrica se utiliza para interrumpir por completo el suministro de alimentación eléctrica a la unidad y debe de encontrarse en un lugar al que el usuario tenga fácil acceso.

**NOTE ON USE**

- Avoid high temperatures. Allow for sufficient heat dispersion when installed in a rack.
- Handle the AC adapter cord carefully. Hold the plug when unplugging the cord.
- Keep the unit free from moisture, water, and dust.
- Unplug the AC adapter when not using the unit for long periods of time.
- Do not obstruct the ventilation holes.
- Do not let foreign objects into the unit.
- Do not let insecticides, benzene, and thinner come in contact with the unit.
- Never disassemble or modify the unit in any way.

**OBSERVATIONS RELATIVES A L'UTILISATION**

- Éviter des températures élevées. Tenir compte d'une dispersion de chaleur suffisante lors de l'installation sur une étagère.
- Manipuler le cordon adaptateur c.a avec précaution. Tenir la prise lors du débranchement du cordon.
- Protéger l'appareil contre l'humidité, l'eau et la poussière.
- Débrancher le adaptateur c.a lorsque l'appareil n'est pas utilisé pendant de longues périodes.
- Ne pas obstruer les trous d'aération.
- Ne pas laisser des objets étrangers dans l'appareil.
- Ne pas mettre en contact des insecticides, du benzène et un diluant avec l'appareil.
- Ne jamais démonter ou modifier l'appareil d'une manière ou d'une autre.

**NOTAS SOBRE EL USO**

- Evite altas temperaturas. Permite la suficiente dispersión del calor cuando está instalado en la consola.
- Maneje el cordón adaptador de CA con cuidado. Sostenga el enchufe cuando desconecte el cordón de energía.
- Mantenga el equipo libre de humedad, agua y polvo.
- Desconecte el adaptador de CA cuando no utilice el equipo por mucho tiempo.
- No obstruya los orificios de ventilación.
- No deje objetos extraños dentro del equipo.
- No permita el contacto de insecticidas, gasolina y diluyentes con el equipo.
- Nunca desarme o modifique el equipo de ninguna manera.

**CAUTION:**

- The ventilation should not be impeded by covering the ventilation openings with items, such as newspapers, tablecloths, curtains, etc.
- No naked flame sources, such as lighted candles, should be placed on the unit.
- Observe and follow local regulations regarding battery disposal.
- Do not expose the unit to dripping or splashing fluids.
- Do not place objects filled with liquids, such as vases, on the unit.

**ATTENTION:**

- La ventilation ne doit pas être gênée en recouvrant les ouvertures de la ventilation avec des objets tels que journaux, rideaux, tissus, etc.
- Aucune flamme nue, par exemple une bougie, ne doit être placée sur l'appareil.
- Veillez à respecter les lois en vigueur lorsque vous jetez les piles usagées.
- L'appareil ne doit pas être exposé à l'eau ou à l'humidité.
- Ne pas poser d'objet contenant du liquide, par exemple un vase, sur l'appareil.

**PRECAUCIÓN:**

- La ventilación no debe quedar obstruida por haberse cubierto las aperturas con objetos como periódicos, manteles, cortinas, etc.
- No debe colocarse sobre el aparato ninguna fuente inflamable sin protección, como velas encendidas.
- A la hora de deshacerse de las pilas, respete la normativa para el cuidado del medio ambiente.
- No exponer el aparato al goteo o salpicaduras cuando se utilice.
- No colocar sobre el aparato objetos llenos de líquido, como jarras.

**A NOTE ABOUT RECYCLING:**

This product's packaging materials are recyclable and can be reused. Please dispose of any materials in accordance with the local recycling regulations.



When discarding the unit, comply with local rules or regulations.

Batteries should never be thrown away or incinerated but disposed of in accordance with the local regulations concerning battery disposal.

This product and the supplied accessories, excluding the batteries, constitute the applicable product according to the WEEE directive.

**UNE REMARQUE CONCERNANT LE RECYCLAGE:**

Les matériaux d'emballage de ce produit sont recyclables et peuvent être réutilisés. Veuillez disposer des matériaux conformément aux lois sur le recyclage en vigueur.

Lorsque vous mettez cet appareil au rebut, respectez les lois ou réglementations en vigueur.

Les piles ne doivent jamais être jetées ou incinérées, mais mises au rebut conformément aux lois en vigueur sur la mise au rebut des piles.

Ce produit et les accessoires inclus, à l'exception des piles, sont des produits conformes à la directive DEEE.

**ACERCA DEL RECICLAJE:**

Los materiales de embalaje de este producto son reciclables y se pueden volver a utilizar. Disponga de estos materiales siguiendo los reglamentos de reciclaje de su localidad.

Cuando se deshaga de la unidad, cumpla con las reglas o reglamentos locales.

Las pilas nunca deberán tirarse ni incinerarse. Deberá disponer de ellas siguiendo los reglamentos de su localidad relacionados con los desperdicios químicos.

Este producto junto con los accesorios empaquetados es el producto aplicable a la directiva RAEE excepto pilas.

Contents

<b>Getting Started</b>	
Accessories.....	1
Cautions on Handling.....	2
Part Names and Functions.....	2
Top Panel / Rear Panel .....	2
Bottom Panel .....	2
<b>Connections</b>	
iPod Connections.....	3
Connecting the AV Device .....	4
Connecting the AC Adapter .....	4
<b>Playback</b>	
iPod Playback.....	5
Preparations.....	5
Playback Music or Video .....	6
<b>Troubleshooting</b> .....	
7	
<b>Specifications</b> .....	
8	

# Getting Started

Thank you for purchasing this DENON product. To ensure proper operation, please read these owner's manual carefully before using the product. After reading them, be sure to keep them for future reference.

## Accessories

Check that the following parts are supplied with the product.

- ① Owner's manual.....1
- ② Warranty (for U.S.A. & Canada model only).....1
- ③ Service station list.....1
- ④ AC adapter (KSAFC0600150W1UV-1) (for U.S.A. & Canada model) .....1  
AC adapter (KSAFC0600150W1UV-1) (for U.K. model) .....1
- ⑤ Universal adapter (3 types) ..... 1 each
- ⑥ AV/Control cable (Cable length: approx. 6.6 ft / 2 m) .....1

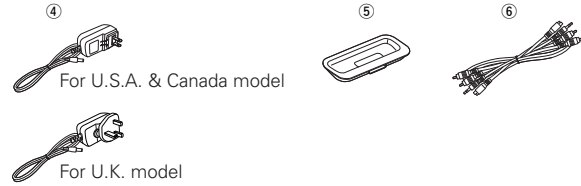

Note that the illustrations in these instructions may differ from the actual unit for explanation purposes.



iPod is a trademark of Apple Inc., registered in the U.S.

※ The iPod may only be used to copy or play contents that are not copyrighted or contents for which copying or playback is legally permitted for your private use as an individual. Be sure to comply with applicable copyright legislation.

**NOTE**

- Do not use any AC adapter other than the specified one. Doing so could result in fires or electric shock.
- The included AC adapter is exclusively for use with this unit. Never use it with other device.

## Cautions on Handling

Pay attention to the following before using this unit:

• **Moving the unit**

To prevent short-circuits or damaged wires in the connection cables, always unplug the power supply cord and disconnect the connection cables between all other audio components when moving the unit.

• **Cautions on using mobile phones**

Using a mobile phone near this unit may result in noise. If so, move the mobile phone away from this unit when using it.

## Part Names and Functions

For buttons not explained here, see the page indicated in parentheses ( ).

### Top Panel / Rear Panel

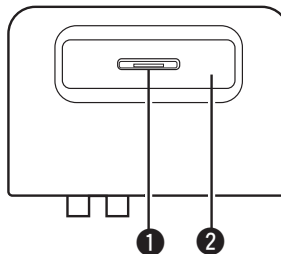

- ① **Dock connector** .....(3)
- ② **Universal adapter slot** .....(3)
- ③ **DOCK CONTROL terminal** .....(4)
- ④ **AUDIO OUT terminals** .....(4)
- ⑤ **S-VIDEO OUT terminal** .....(4)
- ⑥ **DC IN terminal (6V / 0.8A)** .....(4)

**NOTE**

Do not use any AC adapter other than the specified one.

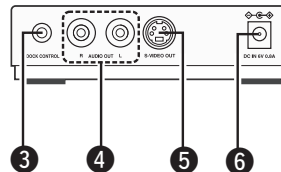

### Bottom Panel

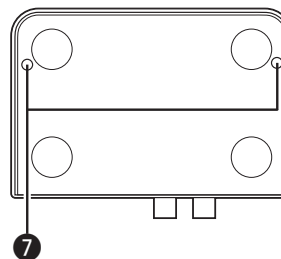

⑦ **Fixing screw holes**



Use the fixing screw holes (two) to fix the control dock by screw.  
(Usable screws: M3, max. 4 mm in length)

# Connections

When the ASD-11R is connected to a DENON AV device equipped with a dock control terminal, various iPod playback operations can be performed from the connected AV device.

**NOTE**

- Do not plug the AC adapter into a power outlet until all connections are completed.
- Also be sure to read the operating instructions of the AV device being connected.

## iPod Connections

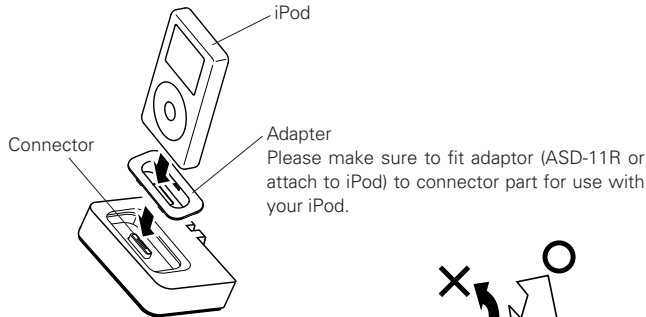

**NOTE**

When plugging in or unplugging the iPod, please proceed carefully, adjusting the inclination of the connector so as not to place a burden upon the connector.

**About the adapter**

Use the adapter included with the iPod.

No adapter is included with the iPods listed below. When using one of these iPods, use the adapter included with the ASD-11R.

iPod	Stamp on back of adapter
iPod mini	mini
iPod Photo 30GB / iPod 20GB with color display	Photo 20GB, 30GB
iPod Photo 60GB / iPod 40GB with color display	Photo 60GB



It is also possible to use a commercially available Apple Inc. adapter.

**NOTE**

- The ASD-11R does not support iPod shuffle.
- Be sure to remove the case when mounting an iPod. Failure to do so can result in faulty connection, in which case the iPod cannot be operated or played.
- Use an adapter suited for your iPod. Using the wrong adapter could damage the connectors on both sides.

**Removing the iPod**

Set the power of the connected AV device to off or standby before removing the iPod.

## Connecting the AV Device

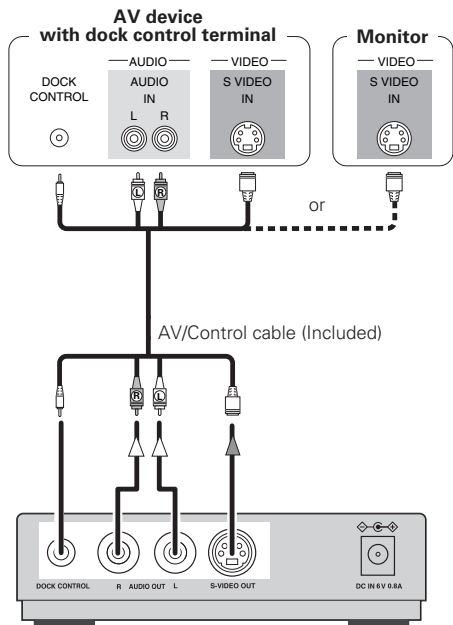

### Signal direction

#### Audio signal

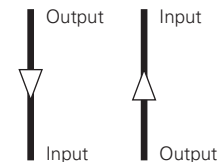

#### Video signal

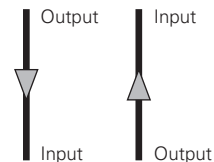

## Connecting the AC Adapter

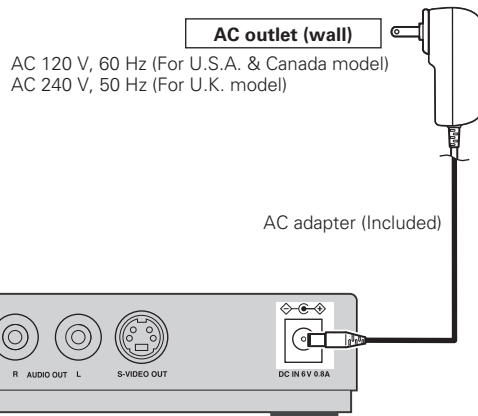

### NOTE

- Connect the AC adaptor to a readily accessible power outlet. If a problem should arise, unplug the AC adaptor immediately.
- Do not use any AC adapter other than the included one.
- Be sure to unplug the AC adaptor from the power outlet when connecting and disconnecting to the plug to the power input terminal.

### □ About the ASD-11R's power operation

There is no power switch on the ASD-11R.

The power turns on when the AC adapter is connected to the ASD-11R and power outlet.

- When playing an iPod, power is supplied to the iPod.
- Power for charging is supplied when the iPod is stopped.
- A standby power (1W) is consumed when no iPod is connected.

Unplug the AC adapter from the power outlet when leaving home or not using for an extended period of time.



# Playback

## iPod Playback

Connect the ASD-11R to the AV device before connecting the iPod to the ASD-11R.

- Connecting the AV device (👉 page 4)
- iPod connections (👉 page 4)

**Perform all the operations on the AV device or iPod connected to the ASD-11R.**

**NOTE**

The method of operation differs according to the connected AV device. For details, refer to the section on playing iPods in the AV device's operating instructions.

### Preparations

**1** Switch the function of the AV device to which the ASD-11R is connected to "iPod".

**2** Operate the AV device to switch the iPod's operating mode.

Browse mode ← → Remote mode

**About the browse and remote modes**

		Browse mode	Remote mode
Where the iPod information is displayed	AV device's display	○	
	Monitor screen	○	
	iPod's display		○
Usable control buttons	AV device	○	○
	iPod		○

## Playing Music or Video

### In the browse mode

Operate the connected AV device.

**1** Select the file you want to play from the menu screen.

**2** Press **ENTER** or **▶**.  
Playback starts.

### In the remote mode

Operation is possible from either the iPod or the connected AV device.

**1** Select the file you want to play from the menu screen.

**2** Press **ENTER**.  
Playback starts.

### Other playback functions

- Pause
- Manual search (fast-reverse / fast-forward)
- Auto search (cue)
- Repeat
- Shuffle

**For details, refer to the section on playing iPods in the AV device's operating instructions.**

#### NOTE

- Note that DENON will accept no responsibility whatsoever for loss of or damage to iPod data when using an iPod connected to the ASD-11R.
- Depending on the iPod's software version, it may not be possible to operate the iPod with the ASD-11R.
- See "[www.denon.com/asd-11r/](http://www.denon.com/asd-11r/)" for details on supported models and connection procedures.

# Troubleshooting

If a problem should arise, first check the following:

1. **Are the connections correct?**
2. **Is the set being operated as described in the owner's manual?**
3. **Are the other components operating properly?**

If this unit does not operate properly, check the items listed in the table below. Should the problem persist, there may be a malfunction.

In this case, disconnect the power immediately and contact your store of purchase.

Symptom	Cause	Countermeasure	Page
No sound is produced. No image appears on the monitor.	• The iPod is not playing.	• Check that the iPod is playing.	-
	• The iPod is not properly connected to the ASD-11R.	• Check that the iPod is properly connected to the ASD-11R's dock connector.	3
	• The AC adapter is not connected to the ASD-11R or a power outlet.	• Check the connections.	4
	• The AV/Control cable is not properly connected.	• Check the connections.	4
	• The monitor's input selection is not properly set.	• Set the monitor's input selector to the proper position for the connected video input terminal.	-

# Specifications

## ❑ Control Dock for iPod (ASD-11R)

<b>Power supply:</b>	DC 6V
<b>Power consumption:</b>	1 W (When iPod is disconnected)
<b>Maximum external dimensions:</b>	104 (W) x 28.5 (H) x 76.5 (D) mm (4-3/32" x 1-1/8" x 3-1/64")
<b>Weight:</b>	220 g (7.8 oz)
<b>Terminal:</b>	Analog audio output terminals x 1, S-Video output terminal x 1, Control terminal x 1

## ❑ AC adapter (KSAFC0600150W1UV-1)

<b>Rated voltage:</b>	100 – 240 V, 50/60 Hz
<b>Rated current:</b>	0.3 A

※ For purposes of improvement, specifications and design are subject to change without notice.

**DENON**

[www.denon.com](http://www.denon.com)

Denon Brand Company, D&M Holdings Inc.  
Printed in China 5411 10147 000D

## Free Manuals Download Website

<http://myh66.com>

<http://usermanuals.us>

<http://www.somanuals.com>

<http://www.4manuals.cc>

<http://www.manual-lib.com>

<http://www.404manual.com>

<http://www.luxmanual.com>

<http://aubethermostatmanual.com>

Golf course search by state

<http://golfingnear.com>

Email search by domain

<http://emailbydomain.com>

Auto manuals search

<http://auto.somanuals.com>

TV manuals search

<http://tv.somanuals.com>