

D0804.01

D220.19

D0801.206

D0801.06

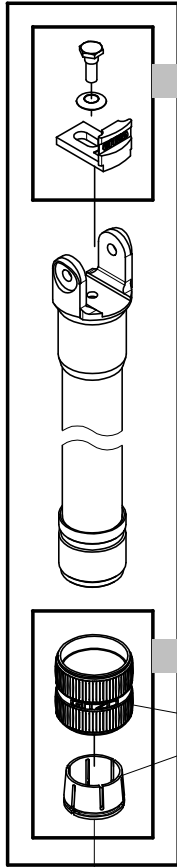

D220.40

D09906.29

D09910.20

D0401.28S

D0402.28

D0301.24

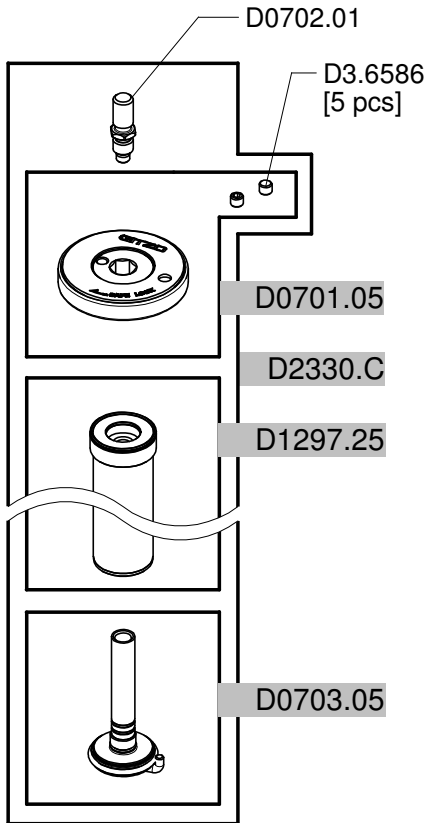

D0702.01

D3.6586  
[5 pcs]

D0701.05

D2330.C

D1297.25

D0703.05

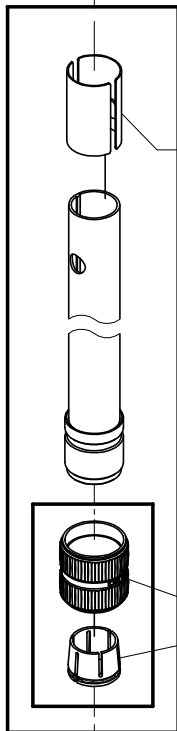

D0201.24  
(2 pcs)

D09909.24

D0401.24S

D0402.24

D0301.20

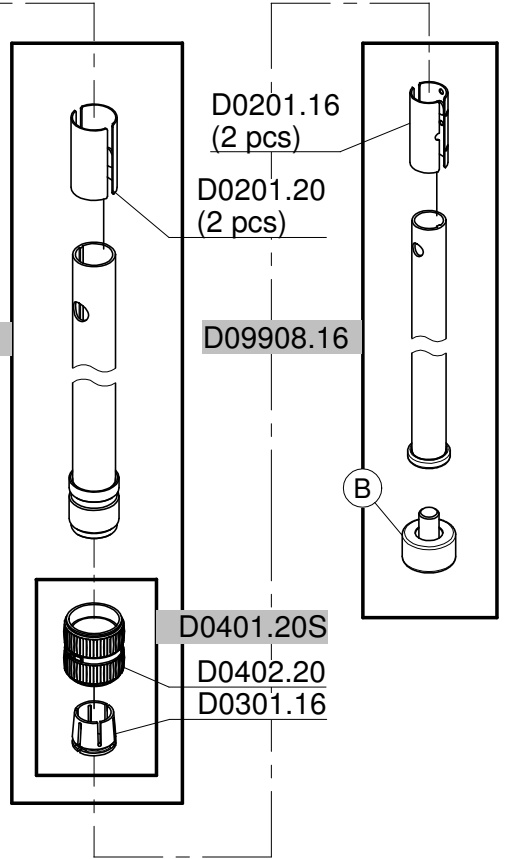

D0201.16  
(2 pcs)

D0201.20  
(2 pcs)

D09908.16

D0401.20S

D0402.20

D0301.16

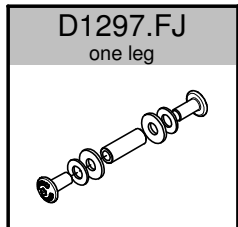

D1297.FJ  
one leg

A

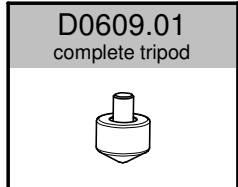

D0609.01  
complete tripod

B

D06.13  
quantity 2



# GT2940C

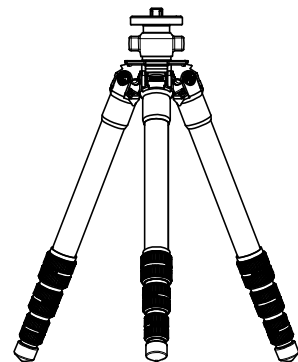

For serial numbers from G0194376

## Free Manuals Download Website

<http://myh66.com>

<http://usermanuals.us>

<http://www.somanuals.com>

<http://www.4manuals.cc>

<http://www.manual-lib.com>

<http://www.404manual.com>

<http://www.luxmanual.com>

<http://aubethermostatmanual.com>

Golf course search by state

<http://golfingnear.com>

Email search by domain

<http://emailbydomain.com>

Auto manuals search

<http://auto.somanuals.com>

TV manuals search

<http://tv.somanuals.com>