

GMC[®]

GLOBAL MACHINERY COMPANY

INSTRUCTION MANUAL

REDEYE[®]

**1/2 HP 12 Speed
Drill Press**

*with Laser Line Generator**



2 YEAR
REPLACEMENT
WARRANTY

30 DAY
SATISFACTION
GUARANTEE

* Patent: Pending

• Melbourne • Perth • Auckland • Hong Kong • Shanghai
• Taipei • New York • Verona • London • Paris

LDP13F
040614 E06 JJ

Contents

Warranty	2
Introduction	3
Environmental protection	3
Description of symbols	3
Specifications	3
Safety rules for laser lights	4
General safety instructions	4
Additional safety rules for drill presses	6
Unpacking	7
Required tools	7
Assembly time	7
Accessories	8
Know your product	9
Assembly	10
Adjustments	11
Adjusting the table height	11
Adjusting the table angle	11
Extension tables	12
Installing and removing drill bits	12
Setting the drilling depth	12
Changing the speed	13
Turning on and off	14
Turning on the REDEYE® laser line generator	14
Adjusting the laser	14
Operation	14
Wood drilling	15
Metal drilling	15
Maintenance	15
Cleaning	15
General inspection	15
Repairs	15
Troubleshooting	16

Full 2 Years Home Use Warranty

Whilst every effort is made to ensure your complete satisfaction with this tool, occasionally, due to the mass manufacturing techniques, a tool may not live up to our required level of performance and you may need the assistance of our service department.

This product is warranted for a 2-year period for home domestic use from the date of the original purchase. If found to be defective in materials or workmanship, the tool or the offending faulty component will be replaced free of charge with another of the same item. A small freight charge may apply.

The warranty replacement unit is only made available by returning the tool to the place of purchase with a confirmed register receipt. Proof of purchase is essential. We reserve the right to reject any claim where the purchase cannot be verified.

This warranty does not include damage or defects to the tool caused by or resulting from abuse, accidents, alterations or commercial or business use.

It also does not cover any bonus accessories unless the tool is a GMC Platinum Professional model.

Please ensure that you store your receipt in a safe place. Conditions apply to the above warranty.

If you need direction of what constitutes a free of charge warranty claim, please review the guide given on the rear of the Receipt Holder. An indication is given as to the types of claim that are permissible, and those that are not.



Dear Customer

If you require any help with your product, whether it is a Warranty claim, spare part or user information, please phone our Help Line for an immediate response. Phone 1300 880 001 in Australia or 0800 445 721 in New Zealand.

Introduction

Your new GMC power tool will more than satisfy your expectations. It has been manufactured under stringent GMC Quality Standards to meet superior performance criteria.

You will find your new tool easy and safe to operate, and, with proper care, it will give you many years of dependable service.

Caution. Carefully read through this entire Instruction Manual before using your new GMC Power Tool. Take special care to heed the Cautions and Warnings.

Your GMC power tool has many features that will make your job faster and easier. Safety, performance, and dependability have been given top priority in the development of this tool, making it easy to maintain and operate.

Environmental protection



Recycle unwanted materials instead of disposing of them as waste. All tools, hoses and packaging should be sorted, taken to the local recycling centre and disposed of in an environmentally safe way.

Warnings.

It may be more difficult to see the laser line in conditions of bright sunshine and on certain surfaces.

Symbols

The rating plate on your tool may show symbols. These represent important information about the product or instructions on its use.



Wear hearing protection.

Wear eye protection.

Wear breathing protection.



N380

Conforms to EMC regulations.

Specifications

Nominal voltage:	230–240Vac ~ 50Hz
Power:	375W
Chuck capacity:	13mm
Chuck type:	Keyless
Spindle axis to column distance:	125mm
Maximum spindle travel:	60mm
Speed ranges:	230, 330, 370, 460, 530, 580, 1030, 1160, 1280, 1600, 1790, 2470 RPM
Laser class:	1
Laser wavelength:	650nm
Laser output power:	≤1Mw

Safety rules for laser lights

The laser light/laser radiation used in the GMC REDEYE® system is Class 1 with maximum 1mW power and 650nm wavelengths. These lasers do not normally present an optical hazard, although staring at the beam may cause flash blindness.

Warning. Do not stare directly at the laser beam. A hazard may exist if you deliberately stare into the beam, please observe all safety rules as follows;

- The laser shall be used and maintained in accordance with the manufacturer's instructions.
- Never aim the beam at any person or an object other than the work piece.

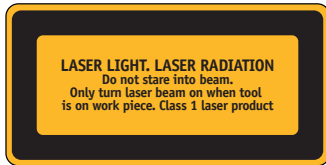

- The laser beam shall not be deliberately aimed at personnel and shall be prevented from being directed towards the eye of a person for longer than 0.25s.
- Always ensure the laser beam is aimed at a sturdy work piece without reflective surfaces. i.e. wood or rough coated surfaces are acceptable. Bright shiny reflective sheet steel or the like is not suitable for laser use as the reflective surface could direct the beam back at the operator.
- Do not change the laser light assembly with a different type. Repairs must only be carried out by the laser manufacturer or an authorised agent.

Caution. Use of controls or adjustments or performance of procedures other than those specified herein may result in hazardous radiation exposure.

Please refer to the relevant Australian standards, AS 2397 and AS/NZS2211 for more information on Lasers.

General safety instructions

To use this tool properly, you must observe the safety regulations, the assembly instructions and the operating instructions to be found in this Manual. All persons who use and service the machine have to be acquainted with this Manual and must be informed about its potential hazards. Children and infirm people must not use this tool. Children should be supervised at all times if they are in the area in which the tool is being used. It is also imperative that you observe the accident prevention regulations in force in your area. The same applies for general rules of occupational health and safety.

Warning. When using power tools, basic safety precautions should always be taken to reduce the risk of fire, electric shock and personal injury. Also, please read and heed the advice given in the additional important safety instructions.

1. **Keep the work area clean and tidy.** Cluttered work areas and benches invite accidents and injury.
2. **Consider the environment in which you are working.** Do not use power tools in damp or wet locations. Keep the work area well lit. Do not expose power tools to rain. Do not use power tools in the presence of flammable liquids or gases.
3. **Keep visitors away from the work area.** All visitors and onlookers, especially children and infirm persons, should be kept well away from where you are working. Do not let others in the vicinity make contact with the tool or extension cord.
4. **Store tools safely.** When not in use, tools should be locked up out of reach.
5. **Do not force the tool.** The tool will do the job better and safer working at the rate for which it was designed.
6. **Use the correct tool for the job.** Do not force small tools or attachments to do the job best handled by a heavier duty tool. Never use a tool for a purpose for which it was not intended.

- 7. Dress correctly.** Do not wear loose clothing or jewellery. They can be caught in moving parts. Rubber gloves and non-slip footwear are recommended when working outdoors. If you have long hair, wear a protective hair covering.
- 8. Use safety accessories.** Safety glasses and earmuffs should always be worn. A face or dust mask is also required if the sanding operation creates dust.
- 9. Do not abuse the power cord.** Never pull the cord to disconnect the tool from the power point. Keep the cord away from heat, oil and sharp edges.
- 10. Secure the work piece.** Use clamps or a vice to hold the work piece. It is safer than using your hand and frees both hands to operate the tool.
- 11. Do not overreach.** Keep your footing secure and balanced at all times.
- 12. Look after your tools.** Keep tools sharp and clean for better and safer performance. Follow the instructions regarding lubrication and accessory changes. Inspect tool cords periodically and, if damaged, have them repaired by an authorised service facility. Inspect extension cords periodically and replace them if damaged. Keep tool handles dry, clean and free from oil and grease.
- 13. Disconnect idle tools.** Switch off the power and disconnect the plug from the power point before servicing, when changing accessories and when the tool is not in use.
- 14. Remove adjusting keys and wrenches.** Check to see that keys and adjusting wrenches are removed from the tool before switching on.
- 15. Avoid unintentional starting.** Always check that the switch is in the OFF position before plugging in the tool to the power supply. Do not carry a plugged in tool with your finger on the switch.
- 16. Use outdoor rated extension cords.** When a tool is used outdoors, use only extension cords that are intended for outdoor use and are so marked.
- 17. Stay alert.** Watch what you are doing. Use common sense. Do not operate a power tool when you are tired.
- 18. Check for damaged parts.** Before using a tool, check that there are no damaged parts. If a part is slightly damaged, carefully determine if it will operate properly and perform its intended function. Check for alignment of moving parts, binding of moving parts, breakage of parts, proper mounting and any other conditions that may affect the operation of the tool. A part that is damaged should be properly repaired or replaced by an authorised service facility, unless otherwise indicated in this Instruction Manual. Defective switches must be replaced by an authorised service facility. Do not use a tool if the switch does not turn the tool on and off correctly.
- 19. Guard against electric shock.** Prevent body contact with grounded objects such as water pipes, radiators, cookers and refrigerator enclosures.
- 20. Use only approved parts.** When servicing, use only identical replacement parts. Use an authorised service facility to fit replacement parts.

Additional safety rules for drill presses

Warning. For your own safety, do not try to use your drill press or plug it in until it is completely assembled and installed according to the instructions and until you have read and understood the following:

1. Your drill press must be bolted securely to a workbench. In addition, if there is any tendency for your drill press to move during certain operations, bolt the workbench to the floor.
2. This drill press is intended for use in dry conditions and indoor use only.
3. Always wear safety goggles which comply to a recognised standard. Use a face or dust mask along with safety goggles if the drilling operation is dusty. Use ear protectors, especially during extended periods of operation.
4. Do not try to drill material too small to be securely held. Do not drill material that does not have a flat surface unless it is clamped securely.
5. Always keep hands out of the path of the drill bit. Avoid awkward hand positions where a sudden slip could cause your hand to move into the drill bit.
6. Do not install or use any drill bit that exceeds 175mm (7 inches) in length or extends more than 150mm (6 inches) below the chuck jaws. They can suddenly bend outwards or break.
7. Do not use wire wheels, router bits, shaper cutters, circle (fly) cutters or rotary planers on this drill press.
8. When cutting a large piece of material make sure it is fully supported at the table height.
9. Do not perform any operation freehand. Always hold the workpiece firmly against the table so it will not rock or twist. Use clamps or a vise for unstable workpieces.
10. Make sure there are no nails or foreign objects in the part of the workpiece to be drilled.
11. Whenever possible, position the workpiece to contact the left side of the column; if it is too short or the table is tilted, clamp solidly to the table.
12. If the workpiece overhangs the table such that it will fall or tip if not held, clamp it to the table or provide auxiliary support.
13. Set the drill press to a speed appropriate to the job.
14. Do not start the drill press while the drill bit is touching the workpiece.
15. When using a drill press vise, always fasten it to the table.
16. Make sure all clamps and locks are firmly tightened before drilling.
17. Securely lock the head and table support to the column, and the table to the table support before operating your drill press.
18. Never turn your drill press on before clearing the table of all objects (tools, scraps of wood etc.)
19. Before starting the operation, jog the motor switch to make sure the drill bit does not wobble or vibrate.
20. Let the spindle reach full speed before starting to drill. If your drill press makes an unfamiliar noise or if it vibrated excessively, stop immediately, turn the drill press off and unplug it. Do not restart until the problem is corrected.
21. Do not perform layout assembly or setup work on the table while the drill press is in operation.
22. Do not exceed the rpm stated on the bit or accessory. See the instructions that come with the accessory.
23. When drilling large diameter holes, clamp the workpiece firmly to the table. Otherwise, the bit may grab and spin the workpiece at high speed. Do not use fly cutters or multiple-part cutters, as they can come apart or become unbalanced in use.
24. Make sure the spindle has come to a complete stop before touching the workpiece.
25. To avoid injury from accidental starting, always turn the switch off and unplug the drill press before installing or removing any accessory attachment or making any adjustment.

Caution! Do not expose to rain or use in damp locations.

Warning! For your own safety read instruction manual before operating drill press. Wear eye protection, do not wear gloves, necktie or loose clothing, clamp workpiece or brace against column to prevent rotation, use recommended speed for drill accessory and workpiece material.

Unpacking

Due to modern mass production techniques, it is unlikely that your GMC Power Tool is faulty or that a part is missing. If you find anything wrong, do not operate the tool until the parts have been replaced or the fault has been rectified. Failure to do so could result in serious personal injury.

Required tools

The following tools are required to assemble the drill press

- 3mm, 4mm, 6mm Hex Keys (Supplied)
- 16mm Wrench (Not Supplied)
- Phillips Head Screwdriver (Not Supplied)

Assembly time

The LDP13F drill press will take approximately 20 minutes to assemble.

Accessories

The LDP13F is supplied with the following components:

1. Base
2. Column
3. Rack
4. Rack Collar
5. Table
6. Belts (x2)
7. Handle
8. Keyless Chuck
9. Extension Table Locking Knobs (x4)
10. Motor Head
11. Handle
12. Depth Scale
13. Table Lock
14. Worn
15. Hex Keys (x3)
16. Bolts for attaching column to base (x4)
17. Bolt to attach handle



Know your product

1. Laser light on/off switch
2. Laser aperture (x2)
3. On/off switch
4. Pulley cover
5. Base
6. Column
7. Rack
8. Rack Collar
9. Table/Support Assembly
10. Belts (x2)
11. Belt Tension Lever
12. Table Handle
13. Keyless Chuck
14. Extension Table Locking Knobs (x4)
15. Motor Head
16. Feed Handle
17. Depth Gauge
18. Depth Scale/Lock
19. Table Lock
20. Bevel Scale
21. Hex Keys

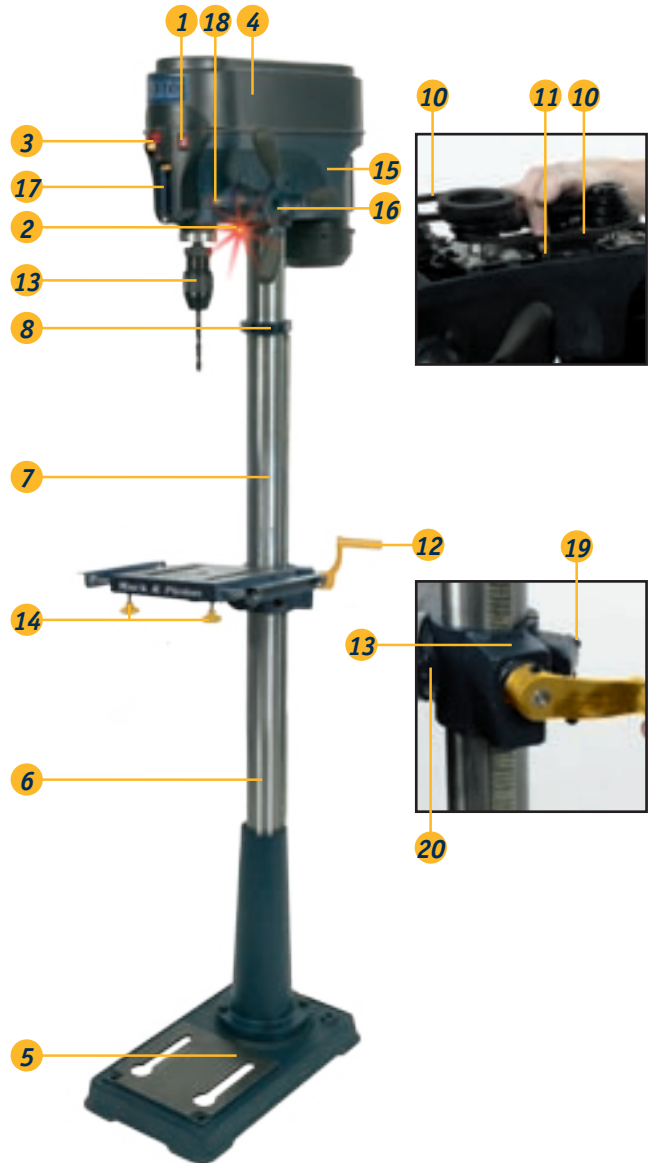

Assembly

1. Place base on floor.
2. Place column assembly on base and align the 4 holes in the column assembly with the holes in the base.
3. Using the 4 10mm diameter x 46mm long bolts secure the column support to the base and tighten with a 16mm wrench.
4. Loosen the screw on the rack collar using the 4mm hex key.
5. Remove the rack collar by lifting it up and over the column.
6. Remove the rack from the column.
7. Ensure that the 4 knobs securing the extension tables are tight.
8. Fully insert the worm gear shaft into the table support and engage it on the gear wheel in the assembly.
9. With the short smooth section of the rack pointing downwards, slide the rack through the round opening in the table support.
10. Engage the rack on the gear mechanism found inside the opening of the table support.
11. Whilst holding the rack and table support slide both over the column. Slide the rack down until the rack is positioned against the lower column support.



12. Fit the rack collar over the column and bring it down to the top of the rack. Ensure the bevel side is down over the rack.



13. Tighten the rack collar using the 4mm hex key. To let the rack slide when the table is swung left or right around the column only tighten the set screw enough to keep the collar in place.



14. Fit the motor head over the column and tighten the 2 grub screws using the 4mm hex key. This will secure the head on the column.

15. Attach the table handle to the worm drive shaft and tighten the grub screw using the 4mm hex key.



16. Fit the table lock into the table support assembly and tighten to secure the table.

17. Fit the depth scale/lock onto the handle.

18. Fit the handle and depth scale onto the motor head ensuring that the flats on the handle locate the flats on the shaft.

19. Secure the handle onto the motor head by placing the handle bolt through the middle of the handle and secure it with the 6mm hex key.

20. Fit the chuck onto the spindle and secure it by pushing it and giving it a sharp tap.

Note. Ensure both surfaces are clean before putting the chuck on the spindle.

21. Place a screwdriver through the top of the pulley cover, loosen and remove the screw securing the pulley cover. Lift off the cover.



22. Fit the belts over the pulleys, refer to the inside of the cover for speed reference.

Note. Fit the lower belt on first.

Note. When fitting belts it is easier to place the belt onto the small pulley and then turn it onto the larger pulley.

23. To tighten the belts on the pulleys pull the motor backwards. This is best done by grabbing hold of the top of the rear pulley and the bottom of the motor housing.

24. To loosen the motor and reduce the belt tension pull the belt tension lever towards the motor and push motor forwards.

25. Replace and secure the pulley cover.

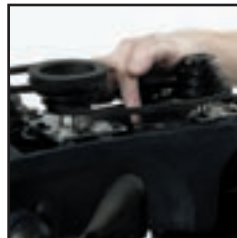

Adjustments

Adjusting the table height

Caution. Always ensure that the drill press is switched off and the plug is removed from the power point before making any adjustments.

1. Loosen the table lock.
2. Rotate the handle in a clockwise direction to raise the table.
3. Rotate the handle in an anti-clockwise direction to lower the table.
4. Tighten the table lock to secure the table.

Adjusting the table angle

Caution. Always ensure that the drill press is switched off and the plug is removed from the power point before making any adjustments.

1. Loosen the screw under the table by rotating it in an anti-clockwise direction.
2. Tilt the table to the desired angle as indicated on the bevel scale.

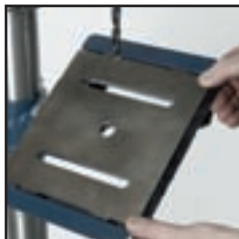

3. Tighten the screw under the table by rotating it in a clockwise direction.

Note. When the table is tilted the work piece should be clamped to the table.

Extension tables

Caution. Always ensure that the drill press is switched off and the plug is removed from the power point before making any adjustments.

1. The extension tables are handy when working with larger work pieces and allow the table size to be increased for greater material support.



2. To adjust the extension table loosen the 2 knobs on the underside of the work table.
3. Extend the extension table to the desired width.
4. Tighten the 2 knobs to secure the extension table in position.

Installing and removing drill bits

Caution. Always ensure that the drill press is switched off and the plug is removed from the power point before making any adjustments.

1. Loosen the chuck sufficiently so that the jaws are open wide enough to allow a bit to be inserted. The chuck is loosened by rotating the collar in a clockwise direction.



2. Place the bit into the open chuck as far as it will go.
3. Tighten the chuck by rotating the collar in an anti-clockwise direction.
4. To remove the bit, loosen the chuck by rotating the collar in a clockwise direction.

Setting the drilling depth

Caution. Always ensure that the drill press is switched off and the plug is removed from the power point before making any adjustments.

1. Loosen the handle screw half a turn using 6mm hex key
2. Ensuring the drill bit is tight in the chuck use the feed wheel to lower the spindle until the drill bit just touches the work piece.



3. Holding the handle in that position rotate the depth scale to the desired drilling depth.
4. Tighten the handle screw firmly to secure the handle in position.



5. Lift the handle up and then proceed with the drilling operation.













6. To disable the depth lock loosen the handle screw and rotate the depth scale to the maximum depth.

7. Tighten the handle screw firmly to secure the handle in position.

Changing the speed

Caution. Always ensure that the drill press is switched off and the plug is removed from the power point before making any adjustments.

The speed of the drill press is determined by the size of the pulley steps that the belt is attached to. Using a smaller pulley step on the front pulley means a faster drill speed; using a larger pulley step on the front pulley means a slower drill speed. The below table indicates the speed of the drill in the various belt positions.

230 	330 	370 	460 
530 	580 	1030 	1160 
1280 	1600 	1790 	2470 



1. Remove the plug from the mains socket.

2. Take off the pulley cover.

3. Loosen the motor and reduce the belt tension by pulling the belt tension lever towards the motor and pushing motor forwards.

4. To select a faster drill speed, move the belt up to a higher step on the front and central pulleys and lower step on the central and rear pulleys. Rotating the pulleys and "rolling" the belt onto the larger pulley will make this easier.

5. To select a slower drill speed, move the belt down to a smaller step on the front and central pulleys and a higher step on the central and rear pulleys. Rotating the pulleys and "rolling" the belt onto the larger pulley will make this easier.

6. To tighten the belts on the pulleys pull the motor backwards. This is best done by grabbing hold of the top of the rear pulley and the bottom of the motor housing.

7. Rotate the pulley by hand to ensure everything is aligned and correct.

8. Replace the pulley cover.

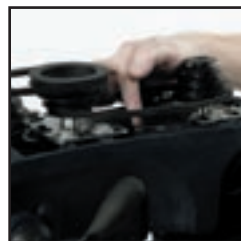

Turning on and off

1. To start the drill press insert the switch disabling insert and move the switch up to the 'ON' position.
2. Move the switch down to the 'OFF' position to turn the drill press off.
3. Remove the switch disabling insert to prevent unauthorised use and store it in a secure location out of reach of children.



Turning on the REDEYE® laser line generator

1. The REDEYE® laser line generator emits two intense narrow beams of pure red light that intersect at the drilling point.
2. The intersection is clearly visible and will not be obscured by dust. It improves operator drilling vision, enables faster set-up, increases accuracy and improves safety.
3. To turn the laser line on move the switch to the 'I' position.
4. To turn off the laser line move the switch to the 'O' position.



Adjusting the laser

1. Clamp a scrap piece of material to the table.
2. Insert a drill bit into the chuck jaws.
3. Turn on the drill press.
4. Using the feed wheel lower the spindle and make a small mark in the workpiece.
5. Turn on the laser line generator.
6. If the laser is not aligned with the mark in the work piece, adjust as follows.
7. Using the 3mm hex key loosen the set screw that secures the laser light assembly.
8. Rotate the laser beam until it intersects the mark in the workpiece.
9. Repeat the process for the other side.

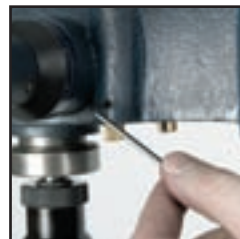

Operation

Caution. Always ensure that the drill press is switched off and the plug is removed from the power point before making any adjustments.

Caution. For through drilling always ensure that the hole in the centre of the table is aligned with the drill bit.

Warning. On start-up over-tightening the belts may prevent the drill press from starting.

Warning. Don't force the drill, allow the drill bit to do the work.

1. Adjust the table height, table angle, drilling depth and

- speed as required for the application.
2. Insert the drill bit required for the application.
 3. Mark the drilling points on the work piece.
 4. Switch on the laser line and line up with the drilling point with the intersection point of the two beams.
 5. Where possible secure the workpiece in position with vice or clamps.
 6. Turn on the drill press using the on/off switch.
 7. Rotate the feed wheel to bring the drill bit down to the workpiece.
 8. Apply pressure to the feed wheel and slowly drill through the workpiece. Don't force the drill, allow the drill bit to do the work.
 9. After drilling the hole release the feed wheel and allow the spindle to return to its original position.
 10. Turn off the drill press.
 11. Turn off the laser line generator.

Wood drilling

- For maximum performance, use high speed steel bits for wood drilling.
- Secure the workpiece to prevent it from turning when drilling.
- When drilling through holes, place a block of wood behind the workpiece to prevent ragged or splintered edges on the back side of the hole.

Metal drilling

- For maximum performance, use high speed steel bits for metal or steel drilling.
- Use a centre punch to mark the hole location on the workpiece.
- Maintain a speed and pressure which allows cutting without overheating the bit. Applying too much pressure will:
 - Overheat the drill
 - Wear the bearings

- Bend or burn bits
- Produce off-centre or irregular shaped holes
- When drilling large holes in metal it is recommended to drill with a small bit at first, then finish with a larger bit. Also, lubricate the bit with oil to improve drilling action and increase bit life.

Maintenance

Warning. Always ensure that the tool is switched off and the plug is removed from the power point before making and adjustments or maintenance procedures.

Cleaning

1. Keep the tool's air vents unclogged and clean at all times.
2. Remove dust and dirt regularly. Cleaning is best done with a soft brush or a rag.
3. Re-lubricate all moving parts at regular intervals.
4. Never use caustic agents to clean plastic parts.

Caution. Do not use cleaning agents to clean the plastic parts of the tool. A mild detergent on a damp cloth is recommended.

General inspection

Regularly check that all the fixing screws are tight. They may vibrate loose over time.

Repairs

Only an authorised service centre should replace the cordset or effect other repairs. If the cordset is damaged or worn, have it repaired or replaced by an authorised service centre.

Troubleshooting

Warning. Turn the on/off switch to the off position and unplug the tool from the power supply before performing trouble shooting procedures.

Troubleshooting		
Problem	Cause	Solution
<i>Drill press will not start</i>	<i>Power cord not plugged in</i>	<i>Ensure that the cord is connected to the power supply</i>
	<i>Power fault, fuse or circuit breaker tripped</i>	<i>Check the power supply</i>
	<i>Cord damaged</i>	<i>Use authorised service centre to repair or replace</i>
	<i>Faulty switch</i>	<i>Use authorised service centre to repair or replace</i>
	<i>Faulty motor</i>	<i>Use authorised service centre to repair or replace the motor</i>
<i>Noisy operation</i>	<i>Incorrect belt tension</i>	<i>Adjust tension as required</i>
<i>Drill bit bums</i>	<i>Incorrect speed</i>	<i>Change speed, refer to the "Changing the speed" section</i>
	<i>Chips not coming out of hole</i>	<i>Retract drill bit frequently to clear holes</i>
	<i>Dull drill bit</i>	<i>Resharpen or replace drill bit</i>
<i>Excessive drill bit wobble</i>	<i>Bent drill bit</i>	<i>Replace with new drill bit</i>
	<i>Drill bit not properly installed in chuck</i>	<i>Install drill bit properly and ensure it is secure</i>
	<i>Chuck not properly installed</i>	<i>Install chuck properly</i>
<i>Wood splinters under workpiece</i>	<i>No "packing" material below workpiece</i>	<i>Use "packers" below the workpiece</i>
<i>Workpiece tom from hand</i>	<i>Workpiece not supported or clamped properly</i>	<i>Support the workpiece or clamp it</i>
<i>Drill bit binds in workpiece</i>	<i>Improper belt tension</i>	<i>Adjust the belt tension</i>

Carefully read the entire Instruction Manual before using this product.

**Before returning this product for a
Warranty Claim or any other reason
Please Call 1300 880 001 (Australia)
or 0800 445 721 (New Zealand)**

**When you make your call, please have
the following information at hand:**

- **GMC Product Type**
- **GMC Product Code**

A GMC Service Engineer will take your call and, in most cases, will be able to solve your problem over the phone.

You are welcome to use this phone-in service to make suggestions or give comments about any GMC product.

With continuing product development changes may have occurred which render the product received slightly different to that shown in this instruction manual. The manufacturer reserves the right to change specifications without notice. Note: Specifications may differ from country to country.



The GMC 777 Helpline operates from 7am to 7pm, 7 days a week (EST). This allows you to contact GMC directly with any queries and technical questions you have regarding our products.



45-55 South Centre Road
Melbourne Airport
Victoria, Australia 3045

Tel: (03) 8346 1100 Fax: (03) 8346 1200



Save this Manual for future reference.

Free Manuals Download Website

<http://myh66.com>

<http://usermanuals.us>

<http://www.somanuals.com>

<http://www.4manuals.cc>

<http://www.manual-lib.com>

<http://www.404manual.com>

<http://www.luxmanual.com>

<http://aubethermostatmanual.com>

Golf course search by state

<http://golfingnear.com>

Email search by domain

<http://emailbydomain.com>

Auto manuals search

<http://auto.somanuals.com>

TV manuals search

<http://tv.somanuals.com>