



# TVisto

## User Guide & Manual

Version 1.0



USB	DOLBY DIGITAL	DOLBY DIGITAL	dts DIGITAL OUT	MP3 AUDIO	MPEG-4 VIDEO	480P / 720P True Progressive
						1080i HDTV VIDEO OUTPUT



August, 2005

Congratulations in buying your TVisto Multimedia Center.

TVisto is a Digital Multimedia Player as well as Data Storage Solution that you can connect to any PC or Mac, either via USB 2.0 or Firewire (plug & play) in order to copy your favorite contents (music, movies, pictures, and/or data files). Once you have transferred your data to TVisto, you can connect it to any TV set to enjoy your movies, music, and photos. You can watch your favorite films in top quality video and Dolby Digital audio.

TVisto is designed for a single 3.5" desktop size hard drive, offering plenty of storage capacity.

This document will provide you with full and comprehensive instructions on how to use your TVisto and benefit from its unique features.

Please start reading the "TVisto Features" chapter in order to have an overview of the enhanced capabilities of your device. A more technical description of these features is presented in the "Specifications" chapter.

Before using the TVisto, be sure that you have received the complete set of accessories by checking the "Package Contents" section.

To have a detailed description of TVisto functionality, read the "PC/MAC Connection" and "TV Connection" chapters in order to explore the full set of operations.

In order to maintain your TVisto device in safe operating conditions and to guarantee life extension, please read the "Safety Information" section.

**TVisto is not designed or intended to, and may not be used to violate any copyrights or other IP (Intellectual Property) rights. Each user of TVisto may only use it in connection with materials legally owned by or licensed to the user and only extend such ownership or license rights that will permit such use.**

All rights reserved. Windows is a registered trademark of Microsoft Corporation. Macintosh, Mac, Mac OS are registered trademarks of Apple Computer, Inc. DivX® Certified and DivX® Video are registered trademarks of DivXNetworks, Inc. Dolby® and Dolby® Digital are registered trademarks of Dolby Laboratories, Inc. All other trademarks and registered trademarks are property of their respective owners.



# Table of Contents

<b>FEATURES OF TVISTO</b> .....	<b>1</b>
<b>EXCLUSIVE DESIGN</b> .....	<b>1</b>
<b>PC CONNECTION</b> .....	<b>2</b>
<b>TV CONNECTION</b> .....	<b>2</b>
<b>AUDIO FEATURES</b> .....	<b>2</b>
<b>VIDEO FEATURES</b> .....	<b>2</b>
<b>MULTILINGUAL</b> .....	<b>2</b>
<b>REMOTE</b> .....	<b>3</b>
<b>FIRMWARE UPDATE</b> .....	<b>3</b>
<b>FORMATTING THE HDD</b> .....	<b>4</b>
<b>FORMATTING ON A PC (WIN2000/XP)</b> .....	<b>4</b>
<b>FORMATTING ON A MAC (OS X)</b> .....	<b>4</b>
<b>CREATING THE DIRECTORIES</b> .....	<b>5</b>
<b>FONT SUPPORT</b> .....	<b>5</b>
<b>PC/MAC CONNECTION</b> .....	<b>6</b>
<b>SAFE REMOVAL</b> .....	<b>7</b>
<b>TV CONNECTION</b> .....	<b>8</b>
<b>ANALOG AUDIO SETUP</b> .....	<b>9</b>
<b>DIGITAL AUDIO SETUP</b> .....	<b>9</b>
<b>THE REMOTE CONTROL</b> .....	<b>10</b>
<b>UNIQUE CONTROL KEYS</b> .....	<b>12</b>
<b>MENU FUNCTIONS</b> .....	<b>13</b>
<b>MAIN MENU</b> .....	<b>13</b>
<b>MOVIES</b> .....	<b>13</b>
<b>MUSIC</b> .....	<b>14</b>
<b>PICTURES</b> .....	<b>14</b>
<b>SETTINGS</b> .....	<b>15</b>
<b>BACKGROUND IMAGE CUSTOMIZATION</b> .....	<b>15</b>
<b>.ISO COMPATIBILITY</b> .....	<b>18</b>
<b>XVID COMPATIBILITY</b> .....	<b>18</b>
<b>DIVX COMPATIBILITY</b> .....	<b>19</b>
<b>SPECIFICATIONS</b> .....	<b>20</b>
<b>PACKAGE CONTENTS</b> .....	<b>21</b>
<b>STANDARD PACKAGE</b> .....	<b>21</b>
<b>SAFETY INFORMATION</b> .....	<b>222</b>
<b>POWER ON/OFF PRECAUTIONS</b> .....	<b>22</b>
<b>LOCATION AND PLACING PRECAUTIONS</b> .....	<b>22</b>
<b>ELECTRICITY AND POWER PLUG</b> .....	<b>22</b>
<b>FAQ</b> .....	<b>23</b>

# Features of TVisto

## Exclusive Design

Everything you love about multimedia, movies, music, and photos is brought to you with TVisto.

TVisto features an elegant, fashionable, and high quality case to protect your device.

The buttons on the front panel of TVisto offer quick access to basic functions for the Multimedia Player, even without remote control. Convenient power on/off switch located on the top, with following indicative colors:

- TV mode: **blue** when power-on and **red** when in stand-by mode. It “blinks” (red intervals) to confirm a command, whenever a button on the remote control is pressed.
- PC mode: **blue** when power-on



On the rear panel, there are following interfaces:

- Firewire 400: IEEE 1394a connection for data transfer (supports daisy chain)
- USB 2.0: High Speed USB 2.0 connection for data transfer
- TV: Multi-Connector for Analog Audio/Video. This multi-pin connector provides all the video and analog audio signals for your TV set.
- SPDIF: Digital audio output for copper coaxial or optical cable
- Mini DIN Jack: Power supply



## PC connection

TVisto can be connected to any PC or Mac via USB or Firewire interface, supporting following file formats: FAT32, NTFS, HFS+. With high speed USB or Firewire connection, you can quickly move large multimedia files from your computer to TVisto. Please note that you will always need an external power adaptor.

## TV connection

TVisto provides the optimum multimedia quality in both audio and video outputs when connected to your TV set and audio system.

### Audio features

- Audio file formats supported: WMA, WAV, MP3, MPEG-4 (AAC), AC3 (Dolby Digital), OGG Vorbis.
- Audio Output Formats: Dual Stereo analog audio, Coaxial/SPDIF digital Audio (supports compressed Dolby Digital 5.1 and DTS pass through).

### Video features

- Video file formats supported: MPEG-1, MPEG-2 (AVI, VOB, ISO), MPEG-4(AVI, DivX, XviD).
- Video Output Formats: NTSC/PAL composite and S-video, Analog YPbPr video (progressive or interlaced) scalable up to 1920x1080i or 1280x720p. RGB via SCART. VGA scalable up to 1024x768.

### DivX compatibility

Supports DivX 3.11, 4.x, 5.x

Supports external text subtitles (SUB (*MicroDVD format*), SRT (*SubRIP format*), SMI (*SAMI format*), embedded multiple subtitles)

Supports any language text subtitles

**Please refer to the “DivX Compatibility” chapter for more details.**

### XviD compatibility

**Please refer to the “XviD Compatibility” chapter for more details.**

### DVD (.ISO) compatibility

ISO=One Image file backup of the complete DVD.

TVisto will play the ISO file exactly the same as if it was running from the original DVD.

Supports .ISO of any size (FAT32/up to 4GB, NTFS/unlimited, HFS+/unlimited).

Supports any language text subtitles.

**Only with TVisto** can you create your own Virtual DVD Library by storing your private collection of DVDs (.ISO format) and watch them as if they were running from the original DVDs. **Please refer to the “.ISO Compatibility” chapter for more details.**

## Multilingual

TVisto has been designed to meet everyone’s expectations. With sophisticated Unicode character handling, it supports most of the major languages used in the menu selection and the subtitle feature. **Refer to “Font Support” for further details.**

## Remote

TVisto is equipped with an elegant infrared remote control, providing standard DVD functionality buttons and more. Please refer to the chapter “TV Connection” for a detailed description of the remote control.

## Firmware update

You will be able to upgrade your device with new features and capabilities by following the firmware<sup>1</sup> upgrade procedure:

- Get the latest update from your vendor’s web site.
- Connect TVisto to your computer and copy the firmware file to the “firmware” folder.
- Connect TVisto to the TV and choose “Firmware Update” from Settings.
- Wait a few minutes for the new firmware to be updated.
- **Never disconnect or turn off your unit before the firmware has been completely updated!!**
- Turn off TVisto by disconnecting the power supply, wait a few seconds, and then connect the power supply again. Wait a few seconds and your TVisto will appear.
- Done!

## Powerful Media Processor

The heart of your TVisto device is a powerful media processor supporting the demanding MPEG-1, MPEG-2 (AVI, VOB, ISO) and MPEG-4(AVI, DivX, XviD) decoding.

## Enjoy

TVisto is the ultimate Digital Multimedia Center that can be addressed to a wide variety of users:

- Home users who want to build a state-of-the-art, versatile home theatre.
- Stores, Agencies, Exhibitors, and Companies that want audio/visual promotion of their products (indoor advertising).
- Business people who want to have a presentation.
- Parents who want to back-up and replay their family videos.
- Movie and music lovers who want to enjoy their favorites at all times.
- People downloading large number of movies and music from the internet.
- Everyone who wants to organize their stack of CDs & DVDs.
- Parents who want to create a “DVD/CD-safe” environment.
- DivX enthusiasts that want to enjoy their DivX/MPEG4 videos with exceptional Dolby Digital (AC3) sound.
- **Every computer fan owning a TV, home theatre, or other A/V equipment.**

---

<sup>1</sup> Firmware is the software stored in the TVisto flash memory that contains the programs running in your device. These programs remain stored even when the system is switched off.



# Formatting the HDD

## Formatting on a PC (Win2000/XP)

Use the Disk Management Utility

- Right click on “My Computer” and choose “Manage”
- Select “Disk Management”
- Choose the drive you want to format and right click on the Disk or drive field for further commands
- Create a **primary NTFS** partition and format it
- Follow the Wizard instructions

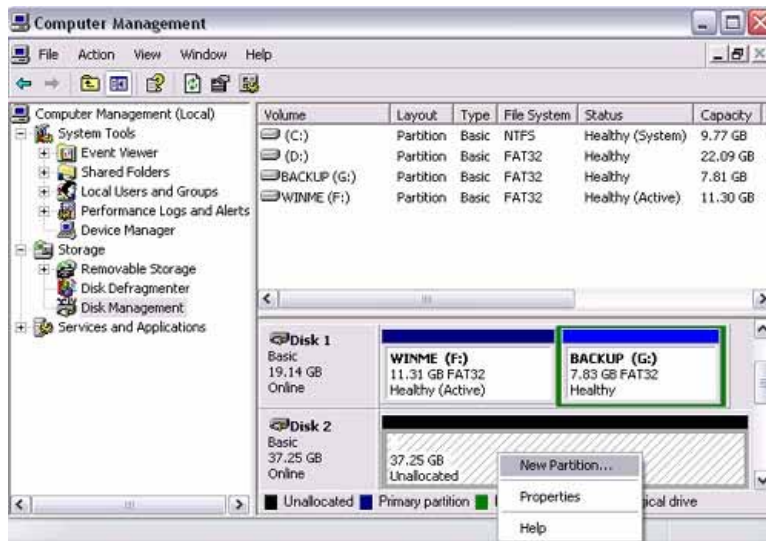

You can also format TVisto using FAT32 but this will have the limitation of max disk being 32GB and max file size being 4GB. **Note: To be able to use the TVisto on all Operating Systems, you will need to use FAT32. To create one single disk over 32GB use the DOS command prompt and the “fdisk” command on Win98/SE or WinME. You may also use 3<sup>rd</sup> party software to create the partition but make sure it is a primary partition.**

## Formatting on a Mac OS X

Use the Disk Utility to format your drive and create a single partition on your external disk.

- Select “Disk Utility” in the utilities folder
- Choose your external drive and format it according to your requirement. For Mac only, choose “**Mac OS Extended**”

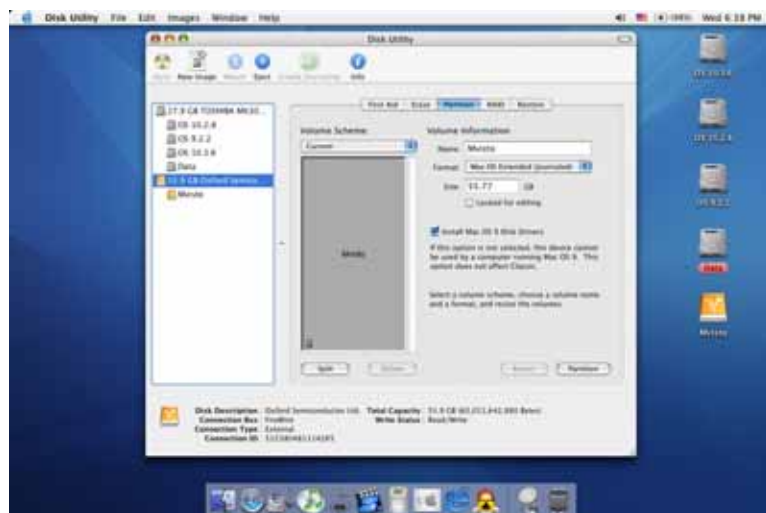

Be aware that formatting the drive will erase all data on it!

**NOTE: To be able to use the TVisto on all Operating Systems, you will need to use FAT32, also called MS-DOS on the Mac OS (max file size limited to 1GB!). To create one single primary partition over 32GB for files up to 4GB, use the DOS command prompt and the “fdisk” command on Win98/SE or WinME.**

# Creating the Directories

For TVisto to be able to find the files on the hard drive, four (4) folders with the exact name shown below must be created first! **ALL the prerequisite folders should have the READ ONLY attribute and should never be deleted or renamed, because your TVisto uses these exact names as a reference to locate the respective files.** Under these directories you can have any directory structure that is convenient to you. Create the folders as shown below, now.

**“Firmware”**: this folder contains the TVisto firmware files. Inside this folder there are two (2) subfolders:

- “Font,” for Europe and US, this is an empty directory.
- “Settings” contains the “Settings.txt” file. This file is a Unicode text file with two strings. The first line string is the default TV mode (PAL or NTSC) in which TVisto should start before the user applies his settings. The second line string is the string used from the TVisto screen saver. This string is user editable and should not be more than 16 characters. Create this file if required, otherwise leave the folder empty.

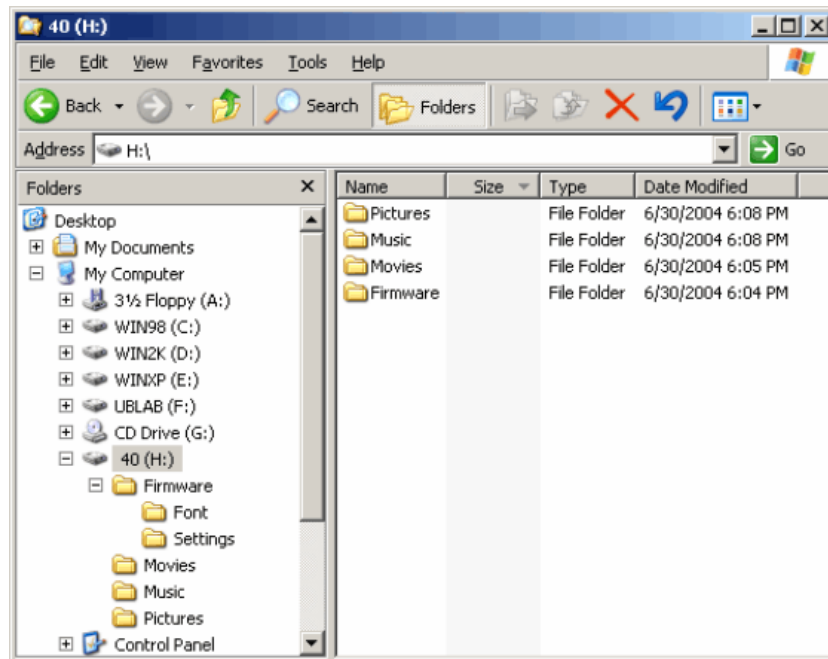

**“Movies”**: This folder contains your movie files.

**“Music”**: This folder contains your music files.

**“Pictures”**: This folder contains your image files.

If you need a directory to transfer your files from one computer to another, you may certainly create more directories and name it whatever you like. These folders won't affect TVisto but will NOT show up on your TV screen!

## Font Support

For additional font support other than English, we recommend copying the 'Arial Unicode MS' font to the “Font” folder located in the “Firmware” directory. On a PC, you can find this font by going to Control Panel and then selecting Fonts. After copying the font to TVisto, rename the file to “font.ttf”. Example: If the original is “arialuni.ttf,” rename it to “font.ttf”.

You may use any other Unicode true type font (TTF) you have or which is available on the internet, but remember to rename the file to “font.ttf” after copying it to TVisto.

# PC/Mac Connection

TVisto automatically operates as an external USB 2.0 or Firewire hard disk when connected to a PC or Macintosh. Use the included cables to connect your device to the computer system. Always connect the USB or Firewire cable to your computer first, before you turn on the device. Your system will automatically recognize TVisto as an external hard disk in which you then can copy any file(s) you want (music, movie, picture, and/or data). **It is strongly recommended to empty the “Recycle Bin” after your file(s) deletions to free the HDD space.**

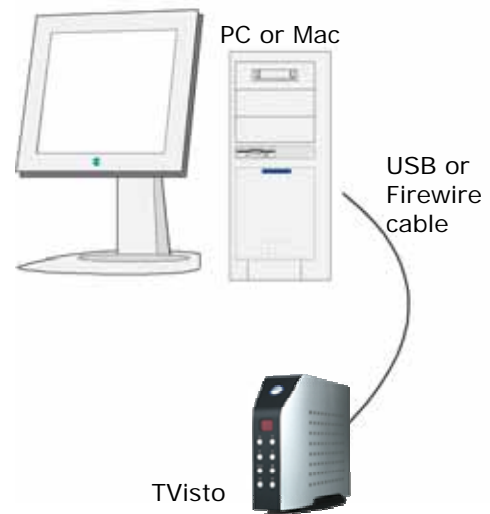

TVisto supports all file formats: FAT32 (Windows 98SE, Windows ME, Mac) NTFS (Windows 2000, Windows XP), HFS+ (Mac). If your computer system does not have a Firewire or USB 2.0 interface, but only USB 1.1, you will receive a warning. You can still use the device with USB 1.1, but with a slower performance level.

TVisto is an external USB 2.0/Firewire hard disk device that can be connected to a variety of Operating Systems supporting the USB or Firewire interface:

- Win98SE (Install driver from CD first)
- Windows Me/2000/XP
- Mac OS9.2, OSX or higher

**NOTE: You will always need the external power adapter when connected to the computer.** The ON/OFF switch is located at the rear of the unit. When connected to the computer, the ON/OFF button on the front is not in use.

**NOTE: Always connect the USB or Firewire cable to your computer first, before you turn on the device.**

**“Firmware”:** this is the folder in which you copy the latest TVisto firmware files found at your vendor’s web site. Inside this folder, you may create two (2) subfolders:

- “Font” for your external Unicode true type font.
- “Settings” for the “Settings.txt” file, which includes your initial standard setting.

**“Movies”:** You will copy your favorite movie files to this folder.

**“Music”:** You will copy your favorite music files to this folder.

**“Pictures”:** You will copy your favorite image files to this folder.

**NOTE: ALL the prerequisite folders listed above have the READ ONLY attribute and should never be deleted or renamed because your TVisto uses these exact names as a reference to locate the respective files.** Under these directories you can have any directory structure that is convenient to you.

If you need a directory to transfer your files from one computer to another, you may certainly create more directories and name it whatever you like. These folders won’t affect TVisto but will NOT show up on your TV screen!

# Safe Removal

In order to safely remove your TVisto from your system, please follow the same procedures as for any external Plug & Play disk drive. Specifically:

**PC:**

Double click on the taskbar icon to “Unplug or Eject hardware”. The adjacent dialogue box will appear, displaying the external Plug & Play devices. In the current example, you can see TVisto as a USB Mass Storage Device.

In order to remove it, click the device in the list and then click Stop.

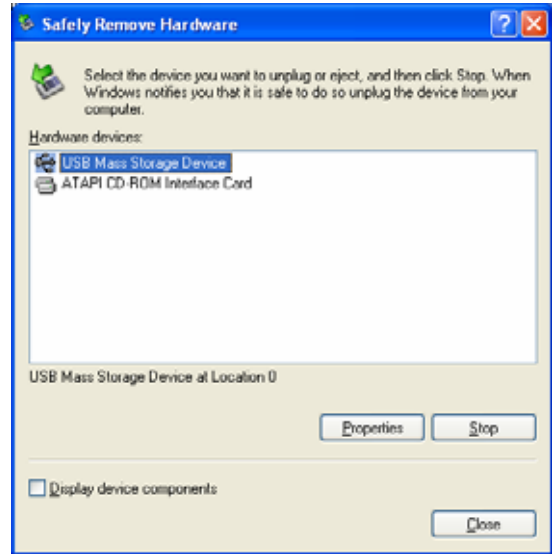

Click OK on the next dialogue box. The operating system will automatically stop the device and inform you for its safe removal. If you are using TVisto (e.g. you are working on a Word document or a picture located in its disk), the operating system will notify you that it is unable to remove the device. In this case, close all the applications affecting or accessing TVisto and try again.

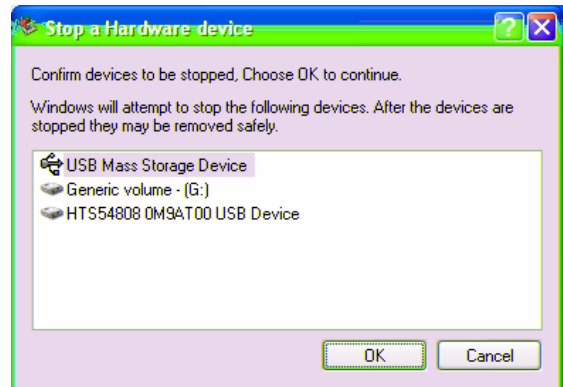

**Mac:**

Drag the drive icon into the trash bin, to eject and remove the drive.

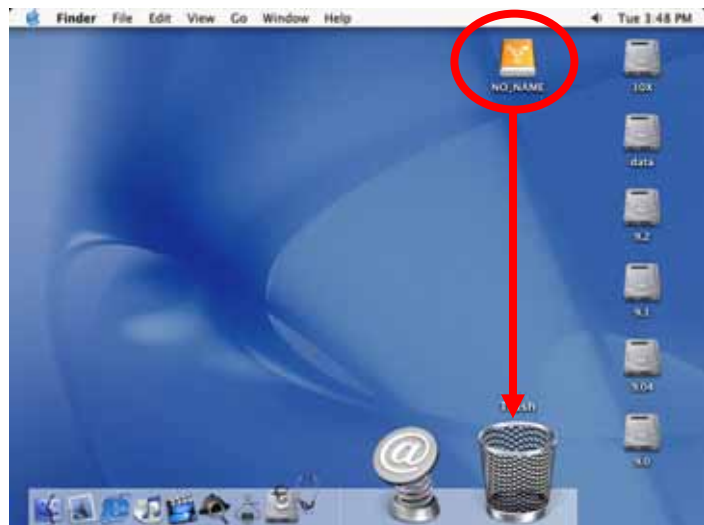

# TV Connection

TVisto provides high quality video and audio output when connected to your TV set and audio system.

The TV connection is straightforward. Just connect TVisto to your TV set (NTSC or PAL) using the included AV cable, plug in the power supply and turn it on.

When using the default AV Cable provided with TVisto, you have Composite video signal, S-Video, and stereo (Left/Right) analog audio out connected to your TV set. If your TV does not have Composite or S-Video, then use the optional SCART adapter to connect it to the SCART port on your TV.

You have the choice to purchase the following optional cables (See page 21):

- AV Cable with Analog YPbPr video (progressive or interlaced) scalable up to 1920x1080i or 1280x720p
- AV Cable with full SCART (RGB) support
- VGA AV adaptor for VGA interface
- SPDIF optical audio cable

Both YPbPr and VGA video cables provide analog L/R audio. The VGA cable provides VGA out scalable up to 1024x768.

TVisto offers the option for two kinds of audio connections, analog or digital. Each requires a cable setup in which the following paragraphs will describe.

## Analog Audio Setup

The simplest configuration is when the analog audio system on your TV set is used. In this case, no matter what type of AV cable you use (the default providing Composite/S-Video signal, one of the optional cables providing Video Component YPbPr, or SCART), the analog audio is provided to the stereo input of your TV by the Left/Right RCA jacks.

This configuration uses only one AV cable connected to the multi-connector port on TVisto.

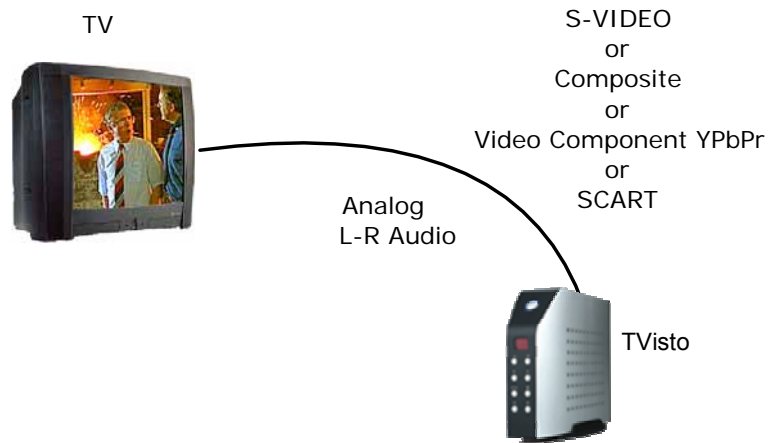

With this simple setup, you can get the highest video quality, but the audio quality remains the stereo analog quality provided by the TV set speakers.

## Digital Audio Setup

This configuration provides the best mix of video and audio quality.

In this setup, you can connect any of the available AV cables except the stereo L/R RCA jacks to the TV set speakers.

Instead, you use the Digital Audio Port of TVisto. Connect this port using the SPDIF copper coaxial or the optional optical audio cable to the digital input of your Dolby Digital or DTS Home Theatre Receiver/Processor. Provided the quality of this receiver and the correct setup of the 5.1 Speaker System, you can experience optimum multimedia quality in both audio and video.

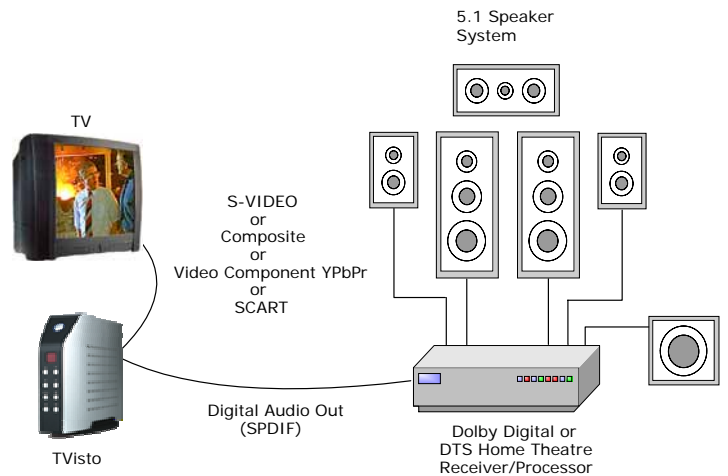



## The Remote Control

The TVisto remote has all the functional capabilities to fully control your device and enjoy your multimedia files. The next figure describes each button's function.

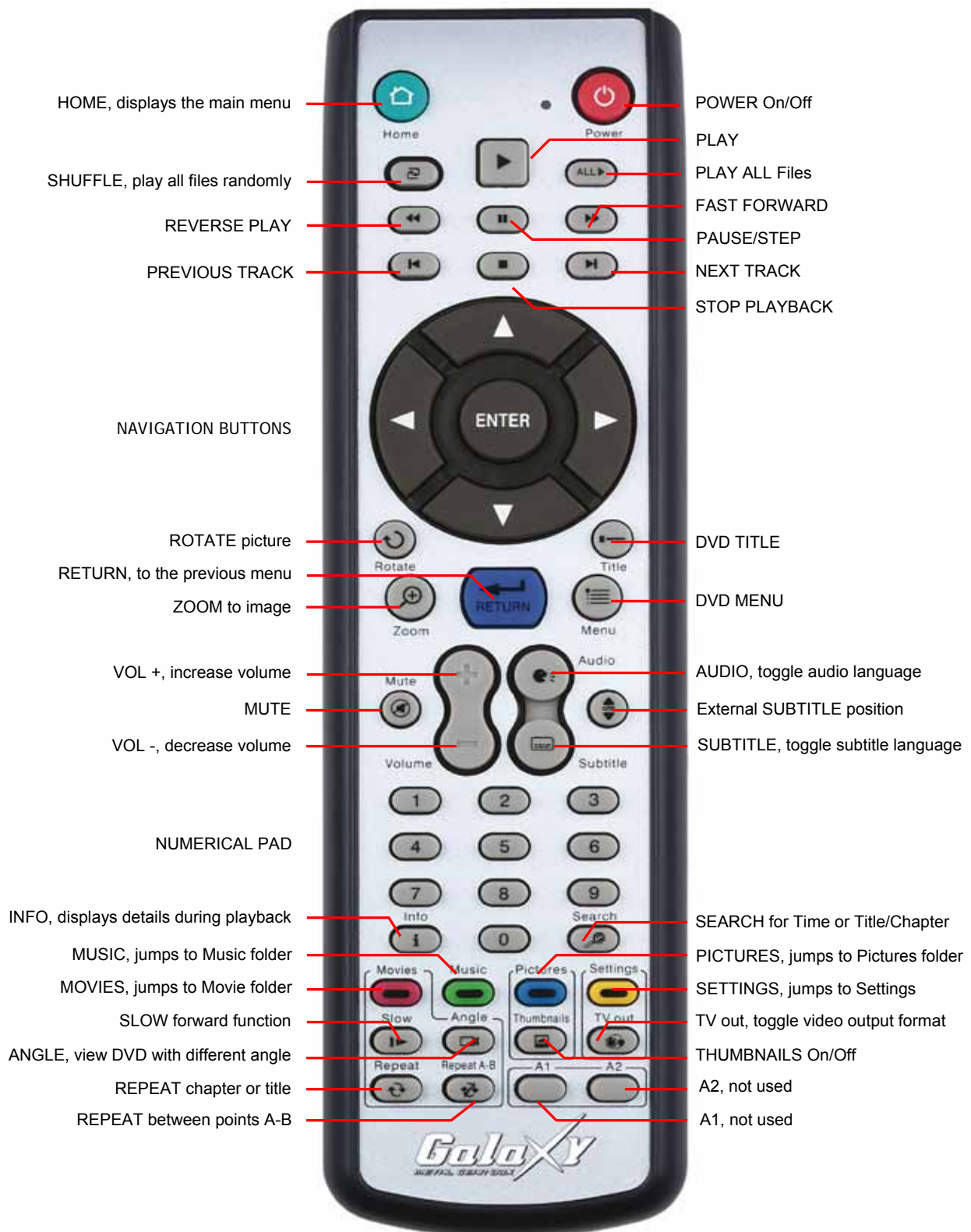

Button	Functionality			
	Movies	Music	Pictures	Settings
HOME	Displays the main menu	Displays the main menu	Displays the main menu	Displays the main menu and saves new settings
POWER	POWER On/Off	POWER On/Off	POWER On/Off	POWER On/Off (not during Firmware update)
SHUFFLE	Play all files randomly	Play all files randomly	Play all files randomly	N/A
PLAY/ENTER	SELECT/PLAY movie	SELECT/PLAY song	SELECT/DISPLAY image	SELECT
PLAY ALL	PLAY ALL Files	PLAY ALL Files	PLAY ALL Files	N/A
REVERSE PLAY	REVERSE PLAY	REVERSE 10 seconds of the song	N/A	N/A
PAUSE/STEP	PAUSE/STEP	PAUSE	N/A	N/A
FAST FORWARD	FAST FORWARD	FORWARD 10 seconds of the song	N/A	N/A
PREVIOUS TRACK	PREVIOUS TRACK (.ISO), PREVIOUS 5 MIN (DivX), PREVIOUS page in file list	Select PREVIOUS song and display PREVIOUS page in file list	Select PREVIOUS image and display PREVIOUS page in file list	N/A
STOP PLAYBACK	STOP PLAYBACK	STOP PLAYBACK	STOP DISPLAY	N/A
NEXT TRACK	NEXT TRACK (.ISO), NEXT 5 MIN (DivX), NEXT page in file list	Select NEXT song and display NEXT page in file list	Select NEXT image and display NEXT page in file list	N/A
ROTATE	N/A	N/A	Rotate picture	N/A
ZOOM	Use arrow keys to stretch image, then press Enter and use arrow keys to scroll	N/A	ZOOM IN (using ⇒ key), ZOOM OUT (using ⇐ key), press Enter and use arrow keys to scroll	N/A
RETURN	Return to the previous menu	Return to the previous menu	Return to the previous menu	Return to the previous menu and cancel command
TITLE	DVD TITLE (.ISO files only)	N/A	N/A	N/A
MENU	DVD MENU (.ISO files only)	N/A	N/A	N/A
MUTE	Mute	Mute	N/A	N/A
VOL +	Increase volume	Increase volume	N/A	N/A
VOL -	Decrease volume	Decrease volume	N/A	N/A
AUDIO	Toggle audio language	N/A	N/A	N/A
SUBTITLE	Toggle subtitle language	N/A	N/A	N/A
SUBTITLE ▲▼	Text SUBTITLE position for DivX files	N/A	N/A	N/A
NUMERICAL PAD	Use for Time Search	Used for Time Search	N/A	N/A
INFO	Displays file information (e.g. size, format, etc)	Displays file information (e.g. size, format, etc)	Displays file information (e.g. size, format, etc)	N/A
SEARCH	SEARCH for Time or Title/Chapter applicable ONLY for .ISO files	Search for Time	N/A	N/A
MOVIES	Go to top folder	Jump to Movies folder	Jump to Movies folder	N/A
MUSIC	Jump to Music folder	Go to top folder	Jump to Music folder	N/A
PICTURES	Jump to Pictures folder	Jump to Pictures folder	Go to top folder	N/A
SETTINGS	Jump to Settings	Jump to Settings	Jump to Settings	Leave Settings and go to Home
SLOW	SLOW forward function (.ISO files only)	N/A	N/A	N/A
ANGLE	View DVD with different angle (.ISO files only)	N/A	N/A	N/A
THUMBNAILS	N/A	N/A	Image preview ON/OFF	N/A
TV OUT	VIDEO OUTPUT, toggle video out format. You can switch between the individual video outputs pressing this button. The video output selected at any time will be shown on the screen. If you cannot see the correct image on the TV or VGA screen, press this button until the image appears.	VIDEO OUTPUT, toggle video out format. You can switch between the individual video outputs pressing this button. The video output selected at any time will be shown on the screen. If you cannot see the correct image on the TV or VGA screen, press this button until the image appears.	VIDEO OUTPUT, toggle video out format. You can switch between the individual video outputs pressing this button. The video output selected at any time will be shown on the screen. If you cannot see the correct image on the TV or VGA screen, press this button until the image appears.	VIDEO OUTPUT, toggle video out format. You can switch between the individual video outputs pressing this button. The video output selected at any time will be shown on the screen. If you cannot see the correct image on the TV or VGA screen, press this button until the image appears.
REPEAT	REPEAT chapter or title, applicable ONLY for .ISO files	N/A	N/A	N/A
REPEAT A-B	REPEAT between points A-B, applicable ONLY for .ISO files	N/A	N/A	N/A
A1	N/A	N/A	N/A	N/A
A2	N/A	N/A	N/A	N/A
INFO 0 1 2 RETURN	By pressing the buttons consecutively: INFO 0 1 2 RETURN, TVisto is set to factory default	By pressing the buttons consecutively: INFO 0 1 2 RETURN, TVisto is set to factory default	By pressing the buttons consecutively: INFO 0 1 2 RETURN, TVisto is set to factory default	By pressing the buttons consecutively: INFO 0 1 2 RETURN, TVisto is set to factory default (not when you select Firmware update)



## Unique Control Keys

TVisto's Remote Control has a full set of buttons in order to provide the user with complete control of the device. The following paragraphs describe the functions of some important buttons; while in the previous table, there is a list of all the keys and their functions.



This key toggles the video out format. You can switch between the individual video outputs pressing this button. The video output selected at any time will be shown on the screen. If you cannot see the correct image on the TV or VGA screen, press this button until the image appears. The video indication banner appears for a few seconds each time you press the **TV OUT** button and also each time you switch on TVisto.

**Toggleing TV OUT does not save the video settings. To do so, select the “Video Settings” from the Settings menu.**

### **INFO, 0, 1, 2, RETURN**

To return to factory default settings, press the above keys successively.



This key allows you to position the external subtitles of DivX movies. When it is pressed, a dual set of white template lines will appear for you to position using the ▲ ▼ keys. Press the button again when done positioning.



Pressing this key, turns the image preview of your photos ON or OFF.



Pressing this key will shuffle all the content in the present folder randomly and start playing back all files inside the folder continuously.

**See previous page for a summary of all control keys for the remote control!**

# Menu Functions

This paragraph presents the various menus and their functions when operating TVisto.

## Main Menu

This is the menu (as shown in the adjacent figure) that appears when you turn on TVisto.

You have four (4) main selections that you can access with the navigation buttons and by pressing PLAY/ENTER:

- Movies
- Music
- Pictures
- Settings



Please look at the following paragraphs for a more detailed description of these menus.

## Movies

Selecting the Movies menu will bring you to the adjacent image on your TV screen. On the right side, you will see the directory list of the Movies organized in your device's hard disk. Each directory is named under left/right brackets: "[", "]". For example, in the directory "[DivX]" we store various DivX movie files. You can make any directory you want with your desired name and store any movie you want in it (use your computer to create and change directories!). Please note that every directory can contain one or more subdirectories and that the directory organization is free to the user.



By using the navigation buttons and the PLAY/ENTER on your remote, you can select the movie you want to play.

Please note that on the left side of the screen are the four main menus also available for your selection.

## Music

Selecting the Music menu will bring you to the adjacent image on your TV screen. On the right side you will see the directory list of the Music files organized in your device's hard disk. Each directory is named under left/right brackets: “[”, “]”. You can make any directory you want with your desired name and store any music file you want in it. Please note that every directory can contain one or more subdirectories and that the directory organization is free to the user (Use your computer to create and change directories!).



By using the navigation buttons and the PLAY/ENTER on your remote, you can select the music file you want to play. Use the INFO button during playback for further details of your present song or see the progress bar on the left side.

Please note that on the left side of the screen are the four main menus also available for your selection.

## Pictures

Selecting the Pictures menu will bring you to the adjacent image on your TV screen. On the right side you will see the directory list of the Pictures organized in your device's hard disk. Each directory is named under left/right brackets: “[”, “]”. You can make any directory you want with your desired name and store any movie you want in it. Please note that every directory can contain one or more subdirectories and that the directory organization is free to the user (Use your computer to create and change directories!).



By using the navigation buttons and the PLAY/ENTER on your remote, you can select the digital picture you want to display. Press the THUMBNAILS button to turn on the image preview on the left corner of your screen. For further commands, refer to page 11.

Please note that on the left side of the screen are the four main menus also available for your selection.

**If you like to listen to some music during the slideshow presentation, create a folder named 'autoMusic' in the root directory of your TVisto and copy your audio files (MP3 – bit rate up to 128kbps) that you wish to playback during the slideshow into that folder. The files will be played in random order until the slideshow is stopped.**

## Settings

The TVisto Settings menu is extremely important in order to correctly configure your device and benefit from its advanced features. In the following paragraphs, there are detailed descriptions of the various settings and parameters.

### Languages

TVisto provides the unique feature to support a multilingual audience. With sophisticated Unicode character handling, it supports most of the major languages used in the menu selection and the subtitle feature of movies. **Refer to the “Font Support” paragraph for further details on how to enable languages other than English.**

Use the ▲ ▼ navigation buttons to select your language and press the PLAY/ENTER button to activate it. Press the HOME button of the remote to save the language setting. Once activated, all the menu selections and wording will switch to the selected language.

### Audio Settings

These settings configure the provided Audio Output Format:

- **Analog** for the Dual Stereo analog audio,
- **Digital** for the Coaxial SPDIF digital audio (supports compressed Dolby Digital 5.1 and DTS pass through).

Use the ▲ ▼ navigation buttons to select your audio setting and press the PLAY/ENTER button to activate it. Press the HOME button on the remote to save the audio setting.

Selecting analog audio out will output the stereo audio to the L/R RCA jack from your AV cable.

Selecting digital audio output will provide digital sound through its SPDIF Digital Audio Port. In this case, you have to connect this port using the SPDIF copper coaxial or optical cable to the digital input of your Dolby Digital or DTS Home Theatre Receiver/Processor in order to take advantage of the high audio quality.

## Background Image Customization

**The background images seen on your TV can be customized!** To do this, connect your TVisto to the computer and create a new folder inside the Firmware folder called “img”. Prepare your new background images and save them inside the “img” folder.

The files have to be saved as JPG, the dimension should be 720x480 with a DPI of 72. Name them exactly as followed: Main.jpg, Movies.jpg, Music.jpg, Photos.jpg and Settings.jpg. If one of these images is missing or not spelled exactly as seen above, none of the customized images will appear on your TV screen! If you don't like the new look, either change the images or simply delete the folder, empty the trash bin and your original background images will show up again.

## Video Settings

These settings configure the provided Video Output Format:

- NTSC Composite/S-Video
- PAL Composite/S-Video
- NTSC Component
- PAL Component
- NTSC SCART
- PAL SCART
  
- High Definition TV at 480p
- High Definition TV at 720p
- High Definition TV at 1080i
  
- VGA (at 1024x768)



Use the ▲ ▼ navigation buttons to select your Video setting. Press PLAY/ENTER button to activate it. Press the HOME button of the remote to save the setting. Once activated, the video out will switch to the selected format. **Please note that you should have already connected the correct cable before configuring the video settings; otherwise, the TV screen may not display properly. For example, before enabling the “NTSC SCART” option, you should have already connected the SCART cable.**

**In case of any setting errors (e.g. the simple Composite AV cable is connected and you setup NTSC Component with no display on the TV screen), press the “VIDEO OUTPUT” key on the remote control repeatedly until you see the correct display. You can then choose the right Video via “Settings” and save it via the HOME button.**

## TV Type

Select one of the listed types of TV display physical aspect ratios.

Press the HOME button on the remote to save the setting.

## Screen Saver

Select the time interval to enable the screen saver when your TVisto device is idle.

There are three (3) predefined time intervals of 5, 10, and 30 minutes, and one to disable the screen saver.

Use the ▲ ▼ navigation buttons to select your screen saver. Press the HOME button of the remote to save the setting.

### **Firmware Update**

This setting performs the firmware update procedure by reading the firmware binary files located in the "Firmware" directory of your device.

#### **Never delete or rename this folder.**

Provided that you have already copied to this directory the latest firmware files downloaded from the official site of your vendor, press enter to start the process. From the menu, you can verify the revision number of the installed version and the revision of the new release.

The firmware update procedure takes approximately 1 minute. Once completed, turn off your device by removing the power supply. Wait a few seconds and connect the power supply again. The new firmware is now saved and in use.

**NOTE: NEVER TURN OFF TVISTO DURING THE FIRMWARE UPDATE PROCEDURE. THIS MAY DAMAGE YOUR DEVICE. IF FOR ANY REASON (E.G. POWER SUPPLY FAILURE DURING FIRMWARE UPDATE) THE PROCEDURE FAILS, YOU MAY NOT BE ABLE TO OPERATE YOUR DEVICE. IN THIS CASE, YOUR DEVICE MAY BE REPLACED WITH A FUNCTIONAL UNIT BY YOUR VENDOR.**

**To return to factory default settings press successively: INFO, 0, 1, 2, RETURN**



# .ISO Compatibility

**Only with TVisto** can you create your own Virtual DVD Library by storing your private collection of DVDs (.ISO format) and watch them as if they were running from the original DVDs.

Once the movies are stored in TVisto as .ISO files, you can play them just like an original DVD with full DVD functions: Menu, Chapter selection, Audio stream selection, Subtitle selection, Fast Forward, Fast Backward, Slow, Pause, Step Forward, Repeat and Search are all included.

An ISO file is the image file on a DVD disk. ISO image files are widely used to store, then transfer DVD contents through the Internet. ISO is a common DVD image format for DOS, Windows, Mac OSX, Linux and other operating systems. TVisto can play the .ISO file exactly the same as if it was running from the original DVD.

The produced files are huge in size, but this is not a limitation for TVisto. As already mentioned, TVisto supports any of the FAT32, NTFS or HFS+ file systems. **Note: The largest single file size on FAT32 is 4GB! If your ISO is bigger then that, you will have to format your hard drive using a different format.**

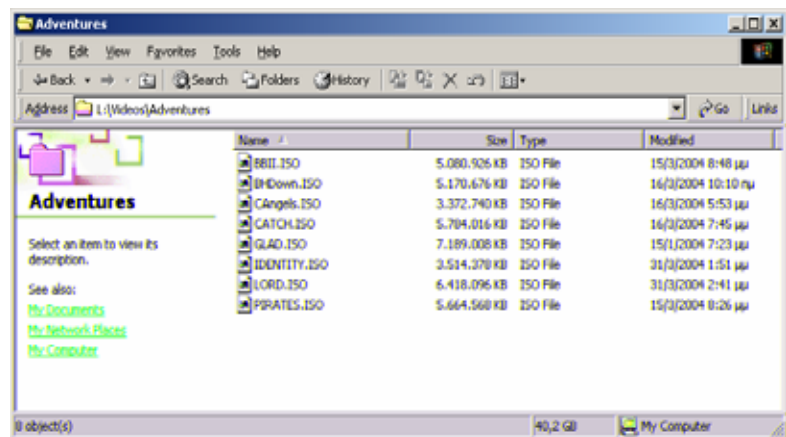

The adjacent figure depicts various .ISO movies that have been produced in less than 12 min each.

**TVisto is not designed or intended to, and may not be used to violate any copyrights or other IP (Intellectual Property) rights. Each user of TVisto may only use it in connection with materials legally owned by or licensed to the user, and only extend such ownership or license rights that will permit such use.**

# XviD Compatibility

XviD is an ISO MPEG-4 compliant video codec. It is not a product; it is an open source project which is developed and maintained by groups of people all over the world.

TVisto is fully compatible with XviD format and can play any movie encoded with this compression format except files encoded using GMC or Qpel.

# DivX Compatibility

DivX® is a new format for digital video. The DivX® codec is based on the MPEG-4 compression standard, which is so advanced that it can reduce an MPEG-2 video (the same format used for DVD) to ten percent of its original size.

TVisto is fully compatible with DivX® format and can play any movie encoded with this compression format no matter which version of the encoder used: 3.11, 4.x, 5.x. GMC and Qpel encoding is not supported on TVisto.

If you want to use external text subtitles, we recommend saving them as .srt or .sub text files. **Please pay attention that in order for TVisto to display the subtitles, both “movie.avi” and “movie.srt” should be placed in the same directory.**

In order for TVisto to display the subtitles, **the subtitle file should be an Unicode file.** To do so, open the .sub, .smi or .srt file with the notepad text editor, select “Save As” and choose the Unicode option from the Encoding combo box. See adjacent image for details.

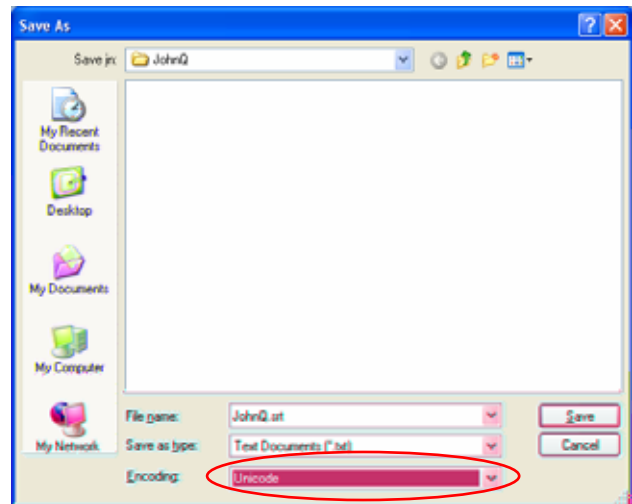



# Specifications

Supported Audio Files Formats	WMA, WAV, MP3, AAC, AC3, OGG Vorbis
Supported Audio Outputs Formats	Dual Stereo analog audio, Coaxial SPDIF digital Audio (supports compressed Dolby Digital 5.1 and DTS pass through).
Supported Video Files Formats	MPEG-1, MPEG-2 (AVI, VOB, ISO), MPEG-4(AVI, DivX, DivX VOD, XviD).
Supported Video Output Formats	NTSC/PAL composite and S-video, Analog YPbPr video (progressive or interlaced) scalable up to 1920x1080i or 1280x720p. RGB via SCART. VGA scalable up to 1024x768
Languages Supported	English, French, German, Italian, Spanish, Greek, Korean, Traditional Chinese, Japanese, Arabic and more to come! (external font is required for languages other than English)
Supported Interfaces	Firewire 400, USB 2.0, SPDIF, CIR
Output Ports	AV multi-connector supporting four (4) cables: <ul style="list-style-type: none"> <li>• Composite RCA, Left Audio RCA, Right Audio RCA, S-Video Mini DIN</li> <li>• RGB Color Component Video 3 RCA, Left Audio RCA, Right Audio RCA</li> <li>• SCART (Europe) with RGB support</li> <li>• VGA at 1024x768</li> </ul>
	USB 2.0 and Firewire 400 (for data transfer to and from computer)
	Transmitter Fiber Optic 8MBps with Copper Jack.
Input Ports	USB 2.0 and Firewire 400 (for data transfer to and from computer)
	IR @ 38KHz
Storage Capacity	Any standard Parallel ATA 3.5" Hard Drive
File Systems Supported	FAT32, NTFS, HFS+ (Mac OS Extended)
Power Input	AC: 100-240V, 1.2A, 50-60Hz DC: +5V/2A, +12V/2A
Dimensions	22.2cm x 15.2cm x 4.8cm
Weight	550 grams (enclosure only)
Operating Temperature/Humidity	0 C to 40 C / 10% to 90% non condensing
Storage Temperature/Humidity	10 C to 30 C / 10% to 90% non condensing

# Package Contents

## Standard Package

- 1) Your TVisto multimedia center.  
(No hard drive included!)
- 2) Power Adapter 110/240V auto switching, +5V/2A, +12V/2A
- 3) Infrared remote control
- 4) Composite AV cable (Composite RCA, S-Video mini DIN, left audio RCA, right audio RCA)
- 5) Coaxial audio cable (RCA to mini jack)
- 6) USB 2.0 High Speed cable
- 7) Firewire 400 (IEEE 1394a), 6 to 6-pin cable
- 8) USB Driver CD (only required for Win98/SE)

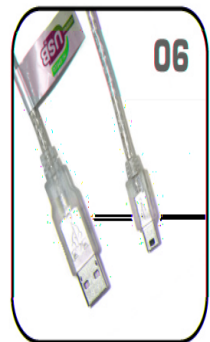
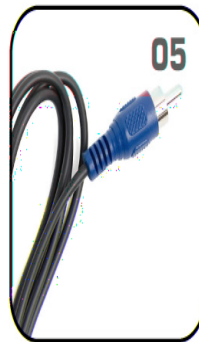

*Note: Package content may vary, depending on vendor & version. The diagrams may also not fully represent the product that you are using and are there for illustration purposes only.*

# Safety Information

Before starting your TVisto, please carefully read the following paragraphs relating to the safety issues on your device in order to extend its life.

## Power on/off precautions

TVisto Remote Control provides the POWER ON/OFF button that controls the power status of your device when connected to the TV. **It is highly recommended to switch the unit off when not in use. In any case, TVisto will switch to stand-by mode if idle for more than 30 minutes.**

When TVisto switches to stand-by, it will change the indication color from BLUE to RED. To remove TVisto and connect it to the computer, turn off the device using the on/off switch at the back of TVisto first!

## Location and placing precautions

Set the TVisto unit up in a vertical position and DO NOT place heavy objects on top of it. Do not place any other objects on top of the unit. Do not place the unit on an amplifier or other equipment that can become hot.

Avoid positioning your TVisto device in the following places:

- Locations with direct sunlight, next to radiators, other sources of heat, or in vehicles that are parked directly in the sun with the windows and doors closed.
- Locations with very high temperature (more than 35° C) or humidity (more than 90%).
- Very dusty or sandy locations.
- Locations subject to vibration, shock, or with a sloping base.

## Electricity and power plug

Careful attention must be paid to the following points in order to avoid operational faults with the equipment and to prevent electric shock, fire, and injury:

- When removing the power cable from the socket, always pull on the plug and never on the cable.
- Do not connect and remove the power cable with wet hands.
- Keep the power cable away from heaters.
- Never try to repair the power cable yourself or to modify it in any way.
- Clean dust, dirt, and etc. from the power plug at regular intervals.
- If the unit is dropped or becomes damaged in any other way, unplug the power cable.
- If the unit should emit smoke, unusual smell, or noise, switch it off and unplug the power cable. In such cases, please contact your dealer.
- If the unit is not used for extended periods, then the power plug should be removed from the socket.

## Cables

**Use only the cables supplied or recommended by your vendor in order to avoid the risk of malfunction, electric shock, and possible interference of the device.**

# FAQ

## **Q: No Files Found!**

A: This message may occur for several reasons. Please check following:

- Does the folder contain any files at all?
- Are the files in the correct folder (example: JPG → Pictures)
- Did you setup all of the 4 prerequisite folders and name them correctly?
- Did you format the hard drive using a PRIMARY partition?
- Did you connect the hard drive properly (MASTER) and is it working on USB?
- Did you use the safe removal process on the computer when disconnecting it?
- If none of the above help, turn off the device, remove the power supply and connect it once more before you contact your vendor for technical support.

## **Q: Scrambled file names** □□□□

A: The Unicode font is missing on your hard drive. See page 5 "Font Support".

## **Q: Blue Screen**

A: Please confirm that your device is plugged into the correct input on your TV set. Make sure you have selected the above input to display on the TV set. If this does not solve the problem, use the "TV out" on your remote control of your TVisto and toggle through the different video output formats until an image appears on the TV set.

Toggling "TV out" does not save the video settings. To do so, select the "Video Settings" from the Settings menu, choose the correct output and press "Home" to save your new settings.

Keep in mind that it takes about 5-8 seconds for TVisto to show up on your TV set after the power has been turned on.

## **Q: No sound**

A: By default, TVisto is using the analog audio output. If you are using a digital amplifier with digital input, go to "Settings" and change the audio output to digital.

## **Q: Playback of HD (High Definition) files**

A: This device does not support playback of HD (High Definition) files like DivX HD or WMV9.

## **Q: Playback of DAT files**

A: DAT files can not be played back on TVisto but you can rename the ".dat" extension to ".mpg" on your computer and playback the file as MPEG-1 movie.

## **Q: How to get the best video quality**

A: From best to worst in regards of the video quality and connection, the order is as followed:

- Component YPbPr 1080i
- Component YPbPr 720p
- Component YPbPr 480p
- Scart RGB
- S-Video
- Composite

S-Video and Composite cables are included in the standard package. For additional and optional SCART or Component cables, please contact your vendor.

The video quality will also depend on your content, whereas MPEG-2 and 4 will be superior to MPEG-1.

## Technical Questions

For RMA and other questions, please contact your vendor or check out their online support area! Make sure to include as much details as possible and explain the problem to your vendor.

Before you contact your vendor, read through the FAQ on the previous page and make sure you are using the latest firmware.

© Copyright 2004 by GMG INC. All Rights Reserved

The information contained in this manual is believed to be accurate and reliable. GMG INC. assumes no responsibility for any errors contained in this manual. GMG INC. reserves the right to make changes in the specifications and/or design of the above mentioned product without prior notice. The diagrams contained in this manual may also not fully represent the product that you are using and are there for illustration purposes only. GMG INC. assumes no responsibility for any differences between the product mentioned in this manual and the product you may have.

August , 2005 / PN: E15-5745100002

## Free Manuals Download Website

<http://myh66.com>

<http://usermanuals.us>

<http://www.somanuals.com>

<http://www.4manuals.cc>

<http://www.manual-lib.com>

<http://www.404manual.com>

<http://www.luxmanual.com>

<http://aubethermostatmanual.com>

Golf course search by state

<http://golfingnear.com>

Email search by domain

<http://emailbydomain.com>

Auto manuals search

<http://auto.somanuals.com>

TV manuals search

<http://tv.somanuals.com>