



# SLIDE COMPOUND MITRE SAW WITH REDEYE®

LSMS210A  
LSMS250A  
INSTRUCTION MANUAL

# GMC®

**GLOBAL MACHINERY COMPANY**

Black

Magenta

Code: LSMS210A & LSMS250A

Cyan

Yellow

Date: 060926

Edition: 03

Op: AB

# Contents

Warranty	2
Introduction	3
Environmental protection	3
Description of symbols	3
Specifications	3
Safety rules for laser lights	4
General safety instructions	4
Additional safety rules for mitre saws	6
Accessories	8
Know your product	9
Unpacking	10
Transportation	10
Bench mounting	10
Release knob	10
Slide lock	10
Mitre table lock	11
Bevel lock	11
Clamp assembly	11
Spindle lock button	11
Rotating lower blade guard	11
Dust bag	11
Attaching the side bars	12
Trench depth adjustment	12
Turning on and off	12
Turning on the REDEYE® laser line generator	12
Setting the table square with the blade	12
Setting the fence square with the table	13
Changing a blade	14
Cross-cutting (without slide action)	15
Cross-cutting (with slide action)	16
Bevel cut	16
Compound mitre cut	17
Adjusting the laser lines	17
Using the laser line generator	18
Maintenance	18
Power cord maintenance	18
Cleaning	18
General inspection	18

## Warranty Powertools

Whilst every effort is made to ensure your complete satisfaction with this tool, occasionally, due to the mass manufacturing techniques, a tool may not live up to our required level of performance and you may need the assistance of our service department.

This product is warranted for a 2-year period for home domestic use from the date of the original purchase. If found to be defective in materials or workmanship, the tool or the offending faulty component will be repaired or replaced free of charge with another of the same item. A small freight charge may apply. Proof of purchase is essential. We reserve the right to reject any claim where the purchase cannot be verified.

This warranty does not include damage or defects to the tool caused by or resulting from abuse, accidents, alterations or commercial or business use. It also does not cover any bonus items or included accessories. Only the powertool is covered under this warranty.

With continuing product development, changes may have occurred which render the product received slightly different to that shown in this instruction manual.

Please ensure that you store your receipt in a safe place.

Conditions apply to the above warranty. For full details of the warranty terms and conditions please refer to our website – [www.gmcompany.com](http://www.gmcompany.com)

For prompt service we suggest you log your service request online - [www.gmcservice.com.au](http://www.gmcservice.com.au), should you not have access to the internet, please contact our service department on 1300 880 001 (Australia) or 0800 445 721 (New Zealand).

## Introduction

Your new GMC power tool will more than satisfy your expectations. It has been manufactured under stringent GMC Quality Standards to meet superior performance criteria.

You will find your new tool easy and safe to operate, and, with proper care, it will give you many years of dependable service.

**CAUTION.** Carefully read through this entire Instruction Manual before using your new GMC Power Tool. Take special care to heed the Cautions and Warnings.

Your GMC power tool has many features that will make your job faster and easier. Safety, performance, and dependability have been given top priority in the development of this tool, making it easy to maintain and operate.

## Environmental protection



Recycle unwanted materials instead of disposing of them as waste. All tools, hoses and packaging should be sorted, taken to the local recycling centre and disposed of in an environmentally safe way.

**WARNING.** It may be more difficult to see the laser line in conditions of bright sunshine and on certain surfaces.

## Description of symbols

The rating plate on your tool may show symbols. These represent important information about the product or instructions on its use.



Wear hearing protection.

Wear eye protection.

Wear breathing protection.



Double insulated for additional protection.



N380

Conforms to relevant standards for electromagnetic compatibility.

## Specifications

### LSMS210A

### LSMS250A

Nominal voltage:	230-240Vac ~ 50Hz	230-240Vac ~ 50Hz
Input power:	1600W	2400W
No load speed:	5000min <sup>-1</sup>	5500min <sup>-1</sup>
Blade size:	Ø210mm x Ø16mm bore	Ø250mm x Ø16mm bore
Number of teeth:	24	24
Mitre angles:	0° to 52° left & right	0° to 52° left & right
Bevel angles:	0° to 45° left	0° to 45° left
Straight cut at 0° x 0°:	200mm x 60mm	295mm x 83mm
Mitre cut at 45° x 0°:	140mm x 60mm	205mm x 83mm
Bevel cut at 0° x 45°:	200mm x 34mm	295mm x 43mm
Compound mitre cut at 45° x 45°:	140mm x 34mm	205mm x 43mm
Insulation class:	Double insulated	Double insulated
Laser class:	II	II
Laser wavelength:	400-700nm	400-700nm
Laser output power:	≤1mW	≤1mW

## Safety rules for laser lights

The laser light/laser radiation used in the GMC REDEYE® system is Class 2 with maximum 1mW and 400nm – 700nm wavelengths. These lasers do not normally present an optical hazard, although staring at the beam may cause flash blindness.

**WARNING.** Do not stare directly at the laser beam.

A hazard may exist if you deliberately stare into the beam, please observe all safety rules as follows;

- The laser shall be used and maintained in accordance with the manufacturer's instructions.
- Never aim the beam at any person or an object other than the workpiece.
- The laser beam shall not be deliberately aimed at personnel and shall be prevented from being directed towards the eye of a person for longer than 0.25s.
- Always ensure the laser beam is aimed at a sturdy workpiece without reflective surfaces. I.e. wood or rough coated surfaces are acceptable. Bright shiny reflective sheet steel or the like is not suitable for laser use as the reflective surface could direct the beam back at the operator.
- Do not change the laser light assembly with a different type. Repairs must be carried out by the laser manufacturer or an authorised agent.



**CAUTION.** Use of controls or adjustments or performance of procedures other than those specified herein may result in hazardous radiation exposure.

Please refer to the relevant Australian standards, AS 2397 and AS/NZS2211 for more information on Lasers.

## General safety instructions

To use this tool properly, you must observe the safety regulations, the assembly instructions and the operating instructions to be found in this Manual. All persons who use and service the machine have to be acquainted with this Manual and must be informed about its potential hazards. Children and infirm people must not use this tool. Children should be supervised at all times if they are in the area in which the tool is being used. It is also imperative that you observe the accident prevention regulations in force in your area. The same applies for general rules of occupational health and safety.

**WARNING.** When using power tools, basic safety precautions should always be taken to reduce the risk of fire, electric shock and personal injury. Also, please read and heed the advice given in the additional important safety instructions.

Even when the tool is used as prescribed it is not possible to eliminate all residual risk factors. The following hazards may arise in connection with the tool's construction and design:

- Contact with the blade.
- Kickback of workpiece and parts of workpiece.
- Blade fracture.
- Catapulting of blade pieces.
- Damage to hearing if effective earmuffs are not worn.
- Harmful emissions of sawdust when the machine is used in closed rooms. Always use supplementary dust extraction where possible.
- Do not use blades that are deformed or cracked.
- Always remove the plug from the mains socket before making any adjustments or maintenance, including changing the blade.

To ensure safe operation of the mitre saw you must follow these guidelines –

- Select the correct blade for the material to be cut.

- Do not use the saw to cut materials other than those recommended by the manufacturer.
- The mitre saw can be safely carried by the main handle but only once it has been removed from the mains power and secured in the locked down position.
- Do not use the saw without the guards in position, in good working order and properly maintained.
- Ensure that the arm is properly secure when bevelling.
- Keep the floor area around the machine level, well maintained and free of loose materials.
- Provide adequate lighting.
- Ensure that you are trained in the use, adjustment and operation of the machine.
- Use correctly sharpened blades and observe the maximum speed marked on the blade.
- Do not remove any cut-offs from the cutting area until the guard is fully locked in place and the blade has come to rest.
- Ensure that the mitre saw is fixed to a bench wherever possible.
- When cutting long pieces which extend well over the table width ensure that the ends are adequately supported at the same height as the saw table top. Supports should be positioned in such a way to ensure that the workpiece does not fall to the ground once the cut has been made. A number of supports at regular intervals may be required if the workpiece is extremely long.

**WARNING.** When using power tools, basic safety precautions should always be taken to reduce the risk of fire, electric shock and personal injury. Also, please read and heed the advice given in the additional important safety instructions.

- 1. Keep the work area clean and tidy.** Cluttered work areas and benches invite accidents and injury.
- 2. Consider the environment in which you are working.** Do not use power tools in damp or wet locations. Keep the work area well lit. Do not expose power tools to rain. Do not use power tools in the presence of flammable liquids or gases.

- 3. Keep visitors away from the work area.** All visitors and onlookers, especially children and infirm persons, should be kept well away from where you are working. Do not let others in the vicinity make contact with the tool or extension cord.
- 4. Store tools safely.** When not in use, tools should be locked up out of reach.
- 5. Do not force the tool.** The tool will do the job better and safer working at the rate for which it was designed.
- 6. Use the correct tool for the job.** Do not force small tools or attachments to do the job best handled by a heavier duty tool. Never use a tool for a purpose for which it was not intended.
- 7. Dress correctly.** Do not wear loose clothing or jewellery. They can be caught in moving parts. Rubber gloves and non-slip footwear are recommended when working outdoors. If you have long hair, wear a protective hair covering.
- 8. Use safety accessories.** Safety glasses and earmuffs should always be worn. A face or dust mask is also required if the drilling operation creates dust.
- 9. Do not abuse the power cord.** Never pull the cord to disconnect the tool from the power point. Keep the cord away from heat, oil and sharp edges.
- 10. Secure the workpiece.** Use clamps or a vice to hold the workpiece. It is safer than using your hand and frees both hands to operate the tool.
- 11. Do not overreach.** Keep your footing secure and balanced at all times.
- 12. Look after your tools.** Keep tools sharp and clean for better and safer performance. Follow the instructions regarding lubrication and accessory changes. Inspect tool cords periodically and, if damaged, have them repaired by an authorised service facility. Inspect extension cords periodically and replace them if damaged. Keep tool handles dry, clean and free from oil and grease.

13. **Disconnect idle tools.** Switch off the power and disconnect the plug from the power point before servicing, when changing accessories and when the tool is not in use.
14. **Remove adjusting keys and wrenches.** Check to see that keys and adjusting wrenches are removed from the tool before switching on.
15. **Avoid unintentional starting.** Always check that the switch is in the OFF position before plugging in the tool to the power supply. Do not carry a plugged in tool with your finger on the switch.
16. **Use outdoor rated extension cords.** When a tool is used outdoors, use only extension cords that are intended for outdoor use and are so marked.
17. **Stay alert.** Watch what you are doing. Use common sense. Do not operate a power tool when you are tired.
18. **Check for damaged parts.** Before using a tool, check that there are no damaged parts. If a part is slightly damaged, carefully determine if it will operate properly and perform its intended function. Check for alignment of moving parts, binding of moving parts, breakage of parts, proper mounting and any other conditions that may affect the operation of the tool. A part that is damaged should be properly repaired or replaced by an authorised service facility, unless otherwise indicated in this Instruction Manual.  
Defective switches must be replaced by an authorised service facility. Do not use a tool if the switch does not turn the tool on and off correctly.
19. **Guard against electric shock.** Prevent body contact with grounded objects such as water pipes, radiators, cookers and refrigerator enclosures.
20. **Use only approved parts.** When servicing, use only identical replacement parts. Use an authorised service facility to fit replacement parts.

**WARNING.** The use of an accessory or attachment, other than those recommended in this Instruction Manual, may present a risk of personal injury.

## Additional safety rules for mitre saws

**WARNINGS.** Before connecting a tool to a power source (mains switch power point receptacle, outlet, etc.) be sure that the voltage supply is the same as that specified on the nameplate of the tool. A power source with a voltage greater than that specified for the tool can result in serious injury to the user, as well as damage to the tool. If in doubt, do not plug in the tool.

Using a power source with a voltage less than the nameplate rating is harmful to the motor.

Your tool is double insulated for additional protection against a possible electrical insulation failure within the tool.

Always remove the plug from the mains socket before making any adjustments or maintenance, including changing the blade.

- When operating the saw, use safety equipment including safety goggles or shield, ear protection, dust mask and protective clothing including safety gloves.
- Ensure that there is adequate general or localised lighting.
- Do not use the saw unless the guards are in place.
- Do not use the saw to cut metal or masonry.
- Do not let anyone under 18 years operate this saw.
- Ensure that the operator is adequately trained in the use, adjustment and operation of the machine.
- Do not use this saw to cut firewood.
- Keep the area free of tripping hazards.
- Report faults in the machine, including guards and saw blades, as soon as they are discovered.
- Ensure that the machine is always fixed to a bench, whenever possible.
- Always stand to one side when operating the saw.
- Never use a cracked or distorted saw blade.
- When cutting round wood, use clamps that prevent the workpiece from turning on both sides of the blade.



- Never use your hands to remove sawdust, chips or waste close by the blade.
- Use only blades as recommended by the manufacturer and which conform to EN 847-1.
- Do not use blades of High Speed Steel (HSS blades).
- If the table insert is damaged or worn, have it replaced by an authorised service centre.
- Rags, cloths, cord and string and the like should never be left around the work area.
- Avoid cutting nails. Inspect the workpiece and remove all nails and other foreign objects before beginning sawing.
- Support the work properly.
- Refrain from removing any cut-offs or other parts of the workpiece from the cutting area whilst the machine is running and the saw head is not in the rest position.
- Do not attempt to free a jammed blade before first switching off the machine.
- Do not slow or stop a blade with a piece of wood. Let the blade come to rest naturally.
- If you are interrupted when operating the saw, complete the process and switch off before looking up.
- Periodically check that all nuts, bolts and other fixings are properly tightened.
- Do not store materials or equipment above a machine in such a way that they could fall into it.
- Always hold the saw on parts that are insulated. If you accidentally cut into hidden wiring or the saw's own cable, the metal parts of the saw will become "live". Switch off at the mains and remove the plug immediately.
- Never saw near combustible liquids or gases.
- Note the direction of rotation of the motor and the blade.
- Do not lock the movable guard in the open position and always ensure that it is working properly, freely rotating and returning to fully cover the teeth of the blade.
- Connect the saw to a dust collection device and ensure that it is operated properly. As the operator of the saw, please make sure that you understand factors that influence exposure to dust, including the type of material to be machined, the importance of local extraction and the proper adjustment of hoods/baffles/shoots of your dust extraction system. We recommend that you always wear a dust mask when operating this saw.
- Wear gloves when handling saw blades and rough materials.
- Saw blades shall be carried in a holder wherever possible.
- Select saw blades in relation to the material being cut.
- Use correctly sharpened saw blades and observe the maximum speed marked on the blade.
- Take additional care when trenching (slotting).
- The mitre saw can be safely carried by the carrying handle but only once it has been removed from the mains power and secured in the locked down position.
- Ensure that the arm is properly secure when bevelling.
- Keep the floor area around the machine level, well maintained and free of loose materials.
- Ensure that you are trained in the use, adjustment and operation of the machine.
- Do not remove any cut-offs from the cutting area until the guard is fully locked in place and the blade has come to rest.
- When cutting long pieces which extend well over the table width, ensure that the ends are adequately supported at the same height as the saw table top. Supports should be positioned in such a way to ensure that the workpiece does not fall to the ground once the cut has been made. A number of supports at regular intervals may be required if the workpiece is extremely long.

**Wear goggles**

**Wear earmuffs**

**Wear a breathing mask**

## Accessories

The GMC LSMS210A and LSMS250A slide compound mitre saws are supplied with the following accessories as standard:

- Saw blade (fitted)
- Workpiece clamp
- 6mm Hex key
- Side bars x2
- Dust bag
- Instruction manual



## Know your product

Before using the saw, familiarise yourself with all the operating features and safety requirements.

- |                              |                                    |  |
|------------------------------|------------------------------------|--|
| 1. Laser light assembly      | 17. Bevel scale                    | 30. Trenching depth adjustment screw         |
| 2. Laser light on/off switch | 18. Fence                          | 31. Trenching stop                           |
| 3. Laser cover               | 19. Stabiliser bar (LSMS250A only) | 32. Trenching depth lock nut                 |
| 4. Laser pitch control       | 20. 6mm Hex key                    | 33. 45° Bevel adjustment screw               |
| 5. Saw arm                   | 21. Mitre table                    | 34. 0° Bevel adjustment screw                |
| 6. Release knob              | 22. Mitre scale                    | 35. Release latch                            |
| 7. Operating handle          | 23. Table insert (kerf plate)      | 36. Side support bars (x2)                   |
| 8. Carrying handle           | 24. Switch trigger                 | 37. Side support bar location holes (2 sets) |
| 9. Upper fixed blade guard   | 25. Mitre lock                     | 38. Side support bar locking screws (x2)     |
| 10. Clamp assembly           | 26. Spindle lock button            |  |
| 11. Clamp assembly lock      | 27. Dust extraction port           |  |
| 12. Rotating blade guard     | 28. Slide bars                     |  |
| 13. Guard retraction arm     | 29. Slide lock                     |  |
| 14. Blade bolt cover         |                                    |  |
| 15. Dust bag                 |                                    |  |
| 16. Bevel lock               |                                    |  |

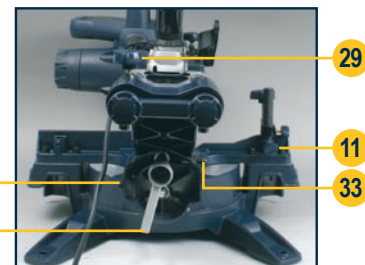
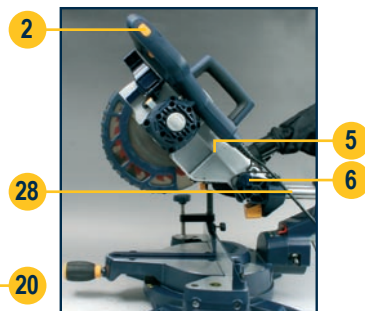
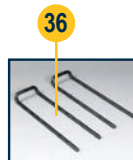
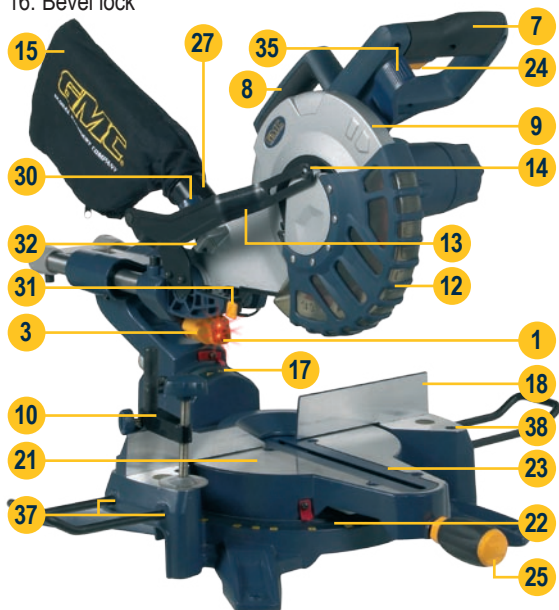

## Unpacking

Due to modern mass production techniques, it is unlikely that your GMC Power Tool is faulty or that a part is missing. If you find anything wrong, do not operate the tool until the parts have been replaced or the fault has been rectified. Failure to do so could result in serious personal injury.

1. Remove all loose parts from the carton.
2. Remove the packing materials from around the saw.
3. Using the carrying handle (8) carefully lift the saw from the carton and place it on a level work surface.
4. The saw has been shipped with the saw arm locked in the down position. To release the saw arm, push down on the top of the saw arm, pull on the release knob (6), rotate it 45° and let go, slowly raise the saw arm.

**WARNING.** Do not lift the saw whilst holding on to the guards. Use the carrying handle (8).

## Transportation

Lift the mitre saw only when the saw arm is locked in the down position, the saw is switched off and the plug is removed from the power point.

Only lift the saw by the carrying handle (8) or outer castings (Fig. A). Do not lift the saw using the guard or operating handle (7).



## Bench mounting

The saw base has holes in each corner to facilitate bench mounting (Fig. B).

1. Mount the saw to a level, horizontal bench or work table using bolts (not supplied) and fix the saw to the bench using 4 bolts.
2. If desired, you can mount the saw to a piece of 13mm or thicker plywood which can then be clamped to your work support or moved to other job sites and re-clamped.

**CAUTION.** Make sure that the mounting surface is not warped as an uneven surface can cause binding and inaccurate sawing.

## Release knob

The release knob (6) is provided for holding the cutting head down whilst transporting or storing the mitre saw (Fig. C). The saw must never be used with the release knob locking the head down.

## Slide lock

When tightened, the slide lock (29) prevents the saw head from sliding. Tighten the slide lock during transportation (Fig. D).

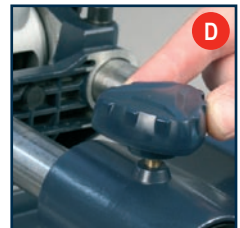
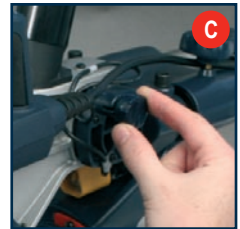

## Mitre table lock

The mitre table lock (25) is used to lock the table at the desired mitre angle (Fig. E).

The mitre saw cuts from 0° to 52° both left and right. To adjust the mitre angle loosen the mitre table lock and using the mitre table handle adjust the mitre angle to the desired position. The mitre table features positive click stops at 0°, 15°, 22.5°, 30°, 45° and 50° for quick setting of common mitre angles.

**WARNING.** Be sure to tighten the mitre table lock before making a cut. Failure to do so could result in the table moving during the cut and cause serious personal injury.

## Bevel lock

The bevel lock (16) is used to set the blade at the desired bevel angle (Fig. F). The mitre saw bevel cuts from 0° to 45° to the left. To adjust the bevel angle loosen the bevel lock and adjust the saw arm to the desired bevel angle.

**WARNING.** Be sure to tighten the bevel lock before making a cut. Failure to do so could result in the saw arm moving during the cut and cause serious personal injury.

## Clamp assembly

The clamp assembly (10) can be mounted to the fence, either side of the saw blade, to suit the task at hand (Fig. G). When performing a bevel cut the workpiece clamp should be positioned on the right hand side of the fence.

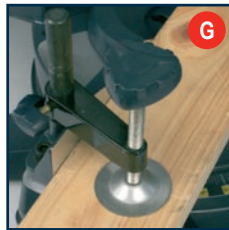

Use the clamp assembly lock (11) at the back of the fence to secure the clamp assembly in position (Fig. H).

## Spindle lock button

The spindle lock button (26) prevents the blade in the saw from rotating (Fig. I). Depress and hold the spindle lock button while installing, changing, or removing the blade.

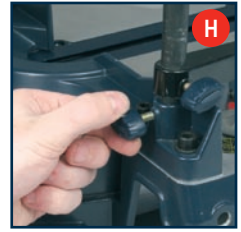

## Rotating lower blade guard

The rotating lower blade guard (12) provides protection from both sides of the blade (Fig. J). It retracts over the upper blade guard (9) as the saw is lowered into the workpiece.



## Dust bag

The dust bag (15) fits over the dust extraction port (27) (Fig. K). For more efficient operation, empty the dust bag when it is no more than half full. This allows better air flow through the bag.

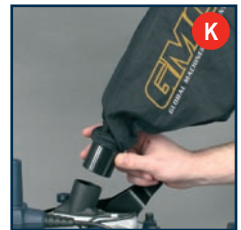

## Attaching the side bars

The side support bars (36) help to support the material when working with long workpieces.

There are two location holes (37) for a support bar on either side of the table. Ensure the side bars are fully inserted before using them to support the workpiece (Fig. L).

The side support bar locking screws (38) must be tightened to secure the support bars in position (Fig. M).

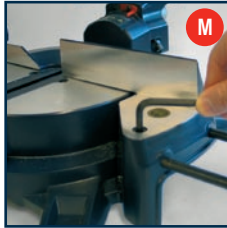

## Trench depth adjustment

In its normal position, the trenching stop (31) permits the saw blade to cut right through a workpiece. When the saw arm is lifted, the trenching stop can be moved to the left so that the trenching depth adjustment screw (30) contacts the stop as the saw arm is lowered. (Fig. N). This restricts the cut to a "trench" in the workpiece. The depth of the trench can be adjusted with the trenching depth adjustment screw (30) (Fig. O) and locked in position with the trenching depth lock nut (32).

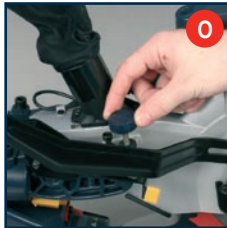
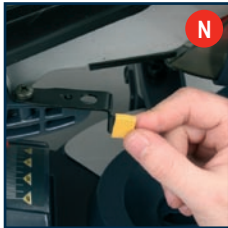

## Turning on and off

1. To turn the saw on depress and hold the on/off trigger switch (24) (Fig. P).
2. To turn the saw off release the on/off trigger switch (24).



## Turning on the REDEYE® laser line generator

The REDEYE® laser line generator emits 2 intense narrow beams of pure red light to guide you as you cut. It improves operator cutting vision, enables faster set-up, increases accuracy and improves safety. To turn on the laser lines press the laser light on/off switch (2) (Fig. Q).

To turn off the laser press the laser light on/off switch (2) one more time.

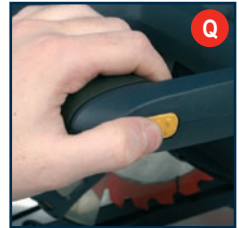

## Setting the table square with the blade

1. Make sure that the electrical plug is removed from the power point.
2. Push the saw arm (5) down to its lowest position and engage the release knob (6) to hold the saw arm in the transport position.
3. Loosen the mitre lock (25) (Fig. R).
4. Rotate the table (21) until the pointer is positioned at 0°.
5. Tighten the mitre lock (25).





- Loosen the bevel lock (16) and set the saw arm (5) at 0° bevel (the blade at 90° to the mitre table). Tighten the bevel lock (16) (Fig. S).
- Place a set square against the table (21) and the flat part of the blade.

**Note.** Make sure that the square contacts the flat part of the saw blade, not the teeth.

- Rotate the blade by hand and check the blade-to-table alignment at several points.
- The edge of the set square and the saw blade should be parallel.
- If the saw blade angles away from the set square, adjust as follows.
- Use a 13mm wrench or adjustable wrench to loosen the lock nut securing the 0° bevel adjustment screw (34) (Fig. T). Also, loosen the bevel lock (16).
- Adjust the 0° bevel adjustment screw (34) with the 6mm hex key to bring the saw blade into alignment with the square.
- Loosen the Phillips head screw holding the pointer of the bevel scale (17) and adjust the position of the pointer so that it accurately indicates zero on the scale. Retighten the screw (Fig. U).

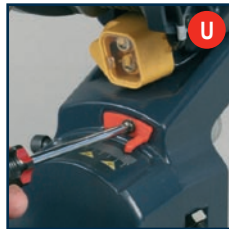
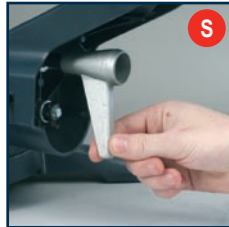

- Retighten the bevel lock (16) and the lock nut securing the 0° bevel adjustment screw (34).

**Note.** The above procedure can also be used to check the angle of the saw blade to the table at 45° bevel angle. The 45° bevel adjustment screw (33) is on the opposite side of the saw arm (Fig. V).



## Setting the fence square with the table

- Make sure that the electrical plug is removed from the power point.
- Push the saw arm (5) down to its lowest position and engage the release knob (6) to hold the saw arm in the transport position.
- Loosen the mitre lock (25).
- Rotate the table (21) until the pointer is positioned at 0°.
- Tighten the mitre lock (25).
- Using the 6mm hex key provided, loosen the four screws securing the fence (18) to the base (Fig. W).
- Place a square against the fence (18) and alongside the blade.
- Adjust the fence (18) until it is square with the blade.
- Tighten the screws securing the fence (18).
- Loosen the Phillips head screw holding the pointer of the mitre scale (22) and adjust it so that it accurately indicates the zero position on the mitre scale (Fig. X).
- Retighten the screw securing the mitre scale pointer.



## Changing a blade

**DANGER!** Never try to use a blade larger than the stated capacity of the saw. It might come into contact with the blade guards. Never use a blade that is too thick to allow the outer blade washer to engage with the flats on the spindle. It will prevent the blade screw from properly securing the blade on the spindle. Do not use the saw to cut metal or masonry. Ensure that any spacers and spindle rings that may be required suit the spindle and the blade fitted.

1. Make sure that the electrical plug is removed from the power point.
2. Push down on the operating handle (7) and pull the release knob (6) to disengage the saw arm (5). The release knob (6) can be turned so that it is held in the retracted position (Fig. Y).
3. Raise the saw arm (5) to its highest position.
4. Using a Phillips head screwdriver loosen and remove the screw that secures the guard retraction arm (13) to the rotating blade guard (Fig. Z).
5. Using a Phillips head screwdriver loosen (Fig. a) and remove the screw that secures the blade bolt cover (14).



6. Pull the rotating blade guard (12) down then swing it up together with the blade bolt cover (14). When the rotating blade guard (12) is positioned over the upper fixed blade guard (9) it is possible to access the blade bolt (Fig. b).
7. Hold the rotating guard (12) up and press the spindle lock button (26) (Fig. c). Rotate the blade until the spindle locks.
8. Use the 6mm hex key provided to loosen and remove the blade bolt. (Loosen in a clockwise direction as the blade screw has a left hand thread) (Fig. d).

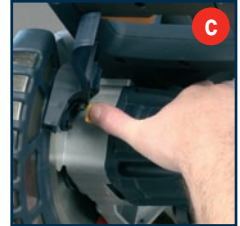

9. Remove the flat washer and outer blade washer and the blade.
10. Wipe a drop of oil onto the inner blade washer and the outer blade washer where they contact the blade.
11. Fit the new blade onto the spindle taking care that the inner blade washer sits behind the blade (Fig. e).



**CAUTION.** To ensure correct blade rotation, always install the blade with the blade teeth and the arrow printed on the side of the blade pointing down. The direction of blade rotation is also stamped with an arrow on the upper blade guard.

12. Replace the outer blade washer (Fig. f).
13. Depress the spindle lock button (26) and replace the flat washer and blade bolt.
14. Use the 6mm hex key to tighten the blade bolt securely (tighten in an anti-clockwise direction).
15. Lower the blade guard, hold the rotating lower blade guard (12) and blade bolt cover (14) in position and tighten the fixing screw (Fig. g).
16. Replace the guard retraction arm and secure onto the rotating blade guard (Fig. h).
17. Check that the blade guard operates correctly and covers the blade as the saw arm is lowered.
18. Connect the saw to the power supply and run the blade to make certain that it is operating correctly.



### Cross-cutting (without slide action)

When cutting a narrow piece of wood it is not necessary to use the slide mechanism. In these cases ensure that the slide lock (29) is screwed down to prevent the saw arm from sliding.

A crosscut is made by cutting across the grain of the workpiece. A 90° crosscut is made with the mitre table set at 0° (Fig. i). Mitre crosscuts are made with the table set at some angle other than zero.



1. Pull on the release knob (6) and lift the saw arm (5) to its full height.
2. Loosen the mitre lock (25).
3. Rotate the mitre table (21) until the pointer aligns with the desired angle.
4. Retighten the mitre lock (25).

**WARNING.** Be sure to tighten the mitre lock before making a cut. Failure to do so could result in the table moving during the cut and cause serious personal injury.

5. Place the workpiece flat on the table with one edge securely against the fence (18). If the board is warped, place the convex side against the fence (18). If the concave side is placed against the fence, the board could break and jam the blade.
6. When cutting long pieces of timber, support the opposite end of the timber with the side support bars (36), a roller stand or a work surface that is level with the saw table.
7. Use the clamp assembly (10) to secure the workpiece wherever possible.
8. It is possible to remove the clamp assembly (10) by loosening the clamp assembly lock (11) and moving it to the other side of the table. Make sure the clamp assembly lock is tight before using the clamp (Fig. j).
9. Before turning on the saw, perform a dry run of the cutting operation to check that there are no problems.
10. Hold the operating handle (7) firmly and squeeze the switch trigger (24). Allow the blade to reach maximum speed.
11. Press the release latch (35) and slowly lower the blade into and through the workpiece.





- Release the switch trigger (24) and allow the saw blade to stop rotating before raising the blade out of the workpiece. Wait until the blade stops before removing the workpiece (Fig. k).



## Cross-cutting (with slide action)

When cutting wide workpieces, first unscrew the slide lock (29).

- Pull on the release knob (6), raise the saw arm (5) to its highest position and slide it towards you (Fig. l).
- Hold the handle firmly and squeeze the switch trigger (24). Allow the blade to reach maximum speed.
- Press the release latch (35) and slowly lower the blade into the workpiece and slide it away from you at the same time until the workpiece is cut.
- Release the switch trigger (24) and allow the saw blade to stop rotating before raising the blade out of the workpiece. Wait until the blade stops before removing the workpiece.



## Bevel cut

A bevel cut is made by cutting across the grain of the workpiece with the blade angled to the fence and mitre table. The mitre table is set at the zero degree position and the blade set at an angle between 0° and 45° (Fig. m).

Use the slide action when cutting wide workpieces.

- Pull on the release knob (6) and lift the saw arm to its full height.



- Loosen the mitre lock (25).
- Rotate the mitre table (21) until the pointer aligns with zero on the mitre scale (22).
- Retighten the mitre lock (25).

**WARNING.** Be sure to tighten the mitre lock before making a cut. Failure to do so could result in the table moving during the cut, causing serious personal injury.

- Loosen the bevel lock (16) and move the saw arm (5) to the left to the desired bevel angle (between 0° and 45°). Tighten the bevel lock (16).
- Place the workpiece flat on the table with one edge securely against the fence (18). If the board is warped, place the convex side against the fence. If the concave side is placed against the fence, the board could break and jam the blade.
- When cutting long pieces of timber, support the opposite end of the timber with the side bars (36), a roller stand or a work surface that is level with the saw table.
- Use the clamp assembly (10) to secure the workpiece wherever possible.
- It is possible to remove the clamp assembly (10) by loosening the clamp assembly lock (11) and moving it to the other side of the table. Make sure the clamp assembly lock is tight before using the clamp.
- Before turning on the saw, perform a dry run of the cutting operation to check that there are no problems.
- Hold the operating handle (7) firmly and squeeze the switch trigger (24). Allow the blade to reach maximum speed.
- Press the release latch (35) and slowly lower the blade into and through the workpiece.
- Release the switch trigger (24) and allow the saw blade to stop rotating before raising the blade out of the workpiece. Wait until the blade stops before removing the workpiece.

## Compound mitre cut

A compound mitre cut involves using a mitre angle and a bevel angle at the same time (Fig. n). It is used in making picture frames, to cut mouldings, making boxes with sloping sides and for roof framing. Always make a test cut on a piece of scrap wood before cutting into the good material.



Use the slide action when cutting wide workpieces.

1. Pull on the release knob (6) and lift the saw arm to its full height.
2. Loosen the mitre lock (25).
3. Rotate the mitre table (21) until the pointer aligns with the desired angle on the mitre scale (22).
4. Retighten the mitre lock (25).

**WARNING.** Be sure to tighten the mitre lock before making a cut. Failure to do so could result in the table moving during the cut, causing serious personal injury.

5. Loosen the bevel lock (16) and move the saw arm (5) to the left to the desired bevel angle (between 0° and 45°). Tighten the bevel lock (16).
6. Place the workpiece flat on the table with one edge securely against the fence (18). If the board is warped, place the convex side against the fence. If the concave side is placed against the fence, the board could break and jam the blade.
7. When cutting long pieces of timber, support the opposite end of the timber with the side bars (36), a roller stand or a work surface that is level with the saw table.
8. Use the clamp assembly (10) to secure the workpiece wherever possible.
9. It is possible to remove the clamp assembly (10) by loosening the clamp assembly lock (11) and moving it to the other side of the table. Make sure the clamp assembly lock is tight before using the clamp.

10. Before turning on the saw, perform a dry run of the cutting operation to check that there are no problems.
11. Hold the operating handle (7) firmly and squeeze the switch trigger (24). Allow the blade to reach maximum speed.
12. Press the release latch (35) and slowly lower the blade into and through the workpiece.
13. Release the switch trigger (24) and allow the saw blade to stop rotating before raising the blade out of the workpiece. Wait until the blade stops before removing the workpiece.

## Adjusting the laser lines

The lower laser is factory set to emit a laser line along the right-hand side of the blade. The upper laser is factory set to emit a laser line to the left-hand side of the blade. This upper laser can be adjusted by the operator to suit blades of different kerf widths.

To adjust the position of the upper laser, proceed as follows:

1. Remove the laser cover by pulling it towards you.
2. Switch on the laser lights with the on/off switch (2) (Fig. o).
3. Using a Phillips head screwdriver (not supplied), adjust the position of the line from the upper laser by turning the laser pitch control (4) (Fig. p).
4. Adjust until the left-hand laser line is aligned with the left-hand side of the blade.
5. Switch off the laser lights.

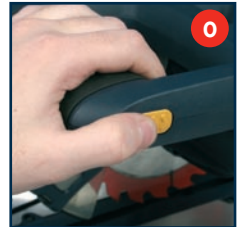

## Using the laser line generator

### WARNINGS.

Do not stare directly at the laser beam.

Never aim the beam at any person or an object other than the workpiece.

Do not deliberately aim the beam at personnel and ensure that it is not directed towards the eye of a person for longer than 0.25s.

Always ensure the laser beam is aimed at a sturdy workpiece without reflective surfaces. Wood or rough coated surfaces are acceptable. Bright shiny reflective surfaces are not suitable for laser use as the reflective surface could direct the beam back at the operator.

Always remember to switch off the laser on/off switch (2) after finishing a job. Only turn the laser beam on when the workpiece is on the mitre saw table.

1. Mark the line of the cut on the workpiece.
2. Adjust the angle of mitre and bevel of the cut as required.
3. Switch on the laser light on/off switch (2).
4. Clamp the workpiece in position using the laser lines to align the blade with the pencil mark on the workpiece.

**Note.** To cut to the left-hand side of the blade, align the left-hand laser line with the pencil mark. To cut to the right-hand side of the blade, align the right-hand laser line with the pencil mark.

5. Plug in the machine and start the motor.
6. Press the release latch (35).
7. When the blade is at its maximum speed (approximately 2 seconds), lower the blade through the workpiece.
8. After completing the cut, switch off the laser light on/off switch (2).
9. After each use, clean the laser light assembly (1) as described below:
  - Switch off the laser light switch (2) and then remove the plug from the power point.

- With the saw arm (5) in the raised position, use a soft brush to dust away the sawdust build-up around the assembly.

**Note.** Wear eye protection whilst brushing the dust away.

### Maintenance

**WARNING.** Always ensure that the tool is switched off and the plug is removed from the power point before making and adjustments or maintenance procedures.

### Power cord maintenance

If the supply cord needs replacing, the task must be carried out by the manufacturer, the manufacturer's agent, or an authorised service centre in order to avoid a safety hazard.

### Cleaning

1. Keep the tool's air vents unclogged and clean at all times.
2. Remove dust and dirt regularly. Cleaning is best done with a soft brush or a rag.
3. Re-lubricate all moving parts at regular intervals.
4. Never use caustic agents to clean plastic parts.

**CAUTION.** Do not use cleaning agents to clean the plastic parts of the saw. A mild detergent on a damp cloth is recommended.

### General inspection

Regularly check that all the fixing screws are tight. They may vibrate loose over time.



---

# GMC customer assist

---

Attach Your  
Receipt Here

If your product needs repairing, replacing, technical service or you simply need help or advice, please contact us on our Customer Assist Line 1300 880 001 (Australia) or 0800 445 721 (New Zealand).

For prompt service we suggest you log your service request online at [www.gmcservice.com.au](http://www.gmcservice.com.au). Should you not have access to the Internet, please contact our service department on 1300 880 001 (Australia) or 0800 445 721 (New Zealand). 7am – 7pm, 7 days a week (AEST).

---

**Please note that if repair or replacement is required, you must provide a valid original purchase receipt.**

---

You will need the following details at hand to log your service request;

**Personal details:** First & Last name, address, pick up address, contact phone numbers, email address

**Product details:** Product number, date of purchase, retailer bought from, State & postcode, receipt number, reason for the request, copy of official purchase receipt

Attach your purchase receipt and save with this Manual for future reference.

Please refer to our website [www.gmcompany.com](http://www.gmcompany.com) for full GMC warranty Terms and Conditions.

**GMC**<sup>®</sup>  
**GLOBAL MACHINERY COMPANY**

## Free Manuals Download Website

<http://myh66.com>

<http://usermanuals.us>

<http://www.somanuals.com>

<http://www.4manuals.cc>

<http://www.manual-lib.com>

<http://www.404manual.com>

<http://www.luxmanual.com>

<http://aubethermostatmanual.com>

Golf course search by state

<http://golfingnear.com>

Email search by domain

<http://emailbydomain.com>

Auto manuals search

<http://auto.somanuals.com>

TV manuals search

<http://tv.somanuals.com>