



# FILING & STORAGE



affordablesolutions

FOR ALL YOUR STORAGE NEEDS



# AT A GLANCE



2

9100 & 9100 PLUS SERIES



4

9800 SERIES



6

9300 & 9300 PLUS SERIES



8

HOTELING LATERALS



9

MOBILE STORAGE SERIES



10

END TAB FILES



11

PEDESTALS



12

PERSONAL STORAGE TOWERS & LOCKERS



14

WARDROBES MULTI-STOR & BOOKSHELVES



16

VERTICAL FILING

## Filing & Storage

Filing & Storage is one of the key elements in any successful business operation. If you are not organized in your material retrieval, then you cannot effectively respond to the demands of your business each and every day. Global provides a variety of innovative and cost effective "Storage Solutions" that can react to your daily demands; making your office and personal work environment more stylish and productive all at the same time.



## Care and the Environment

Cleaning our files is easy. Simply wipe the surface with a soft cloth dampened with a glass cleaning solution. We are proud to have an Earth Friendly painting process which recycles unused paint and overspray.



# 9100 PLUS & 9100 SERIES



## 9100 Plus Series Lateral Files

Lateral files can store 3-ring binders, computer printouts, and file folders in the oversized 'B' drawers in every cabinet. Doors fully recede into the cabinet. Fixed front, looped full pulls and receding doors have an added stiffener. Interlock system prevents tipping by allowing only one drawer to open at a time. Cam locks with removable cores are standard. Additional finishing details, options and inner support channels make this Global's best series.

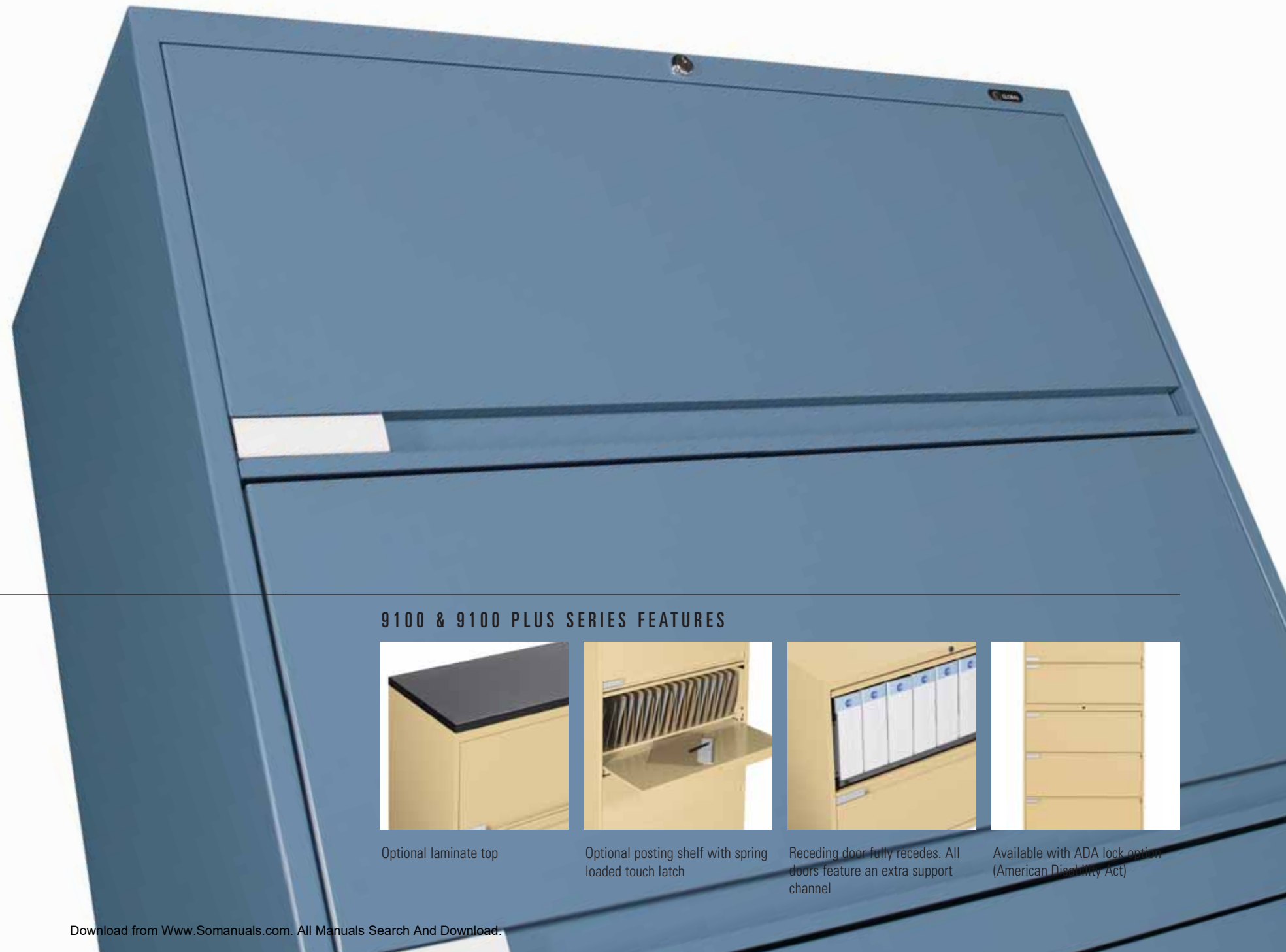

## AVAILABLE DRAWER CONFIGURATIONS

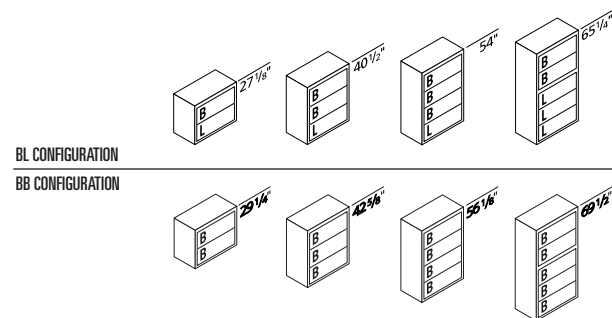

## 9100 & 9100 PLUS SERIES FEATURES



Optional laminate top



Optional posting shelf with spring loaded touch latch



Receding door fully recedes. All doors feature an extra support channel

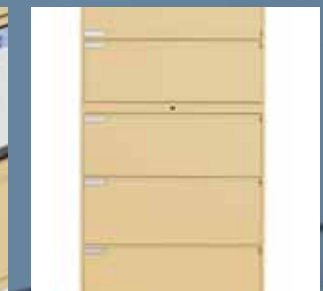

Available with ADA lock option (American Disability Act)



# 9100 PLUS & 9100 SERIES



# 9100 SERIES



## 9100 Plus Series Lateral Files

Lateral files can store 3-ring binders, computer printouts, and file folders in the oversized 'B' drawers in every cabinet. Doors fully recede into the cabinet. Fixed front, looped full pulls and receding doors have an added stiffener. Interlock system prevents tipping by allowing only one drawer to open at a time. Cam locks with removable cores are standard. Additional finishing details, options and inner support channels make this Global's best series.

## AVAILABLE DRAWER CONFIGURATIONS

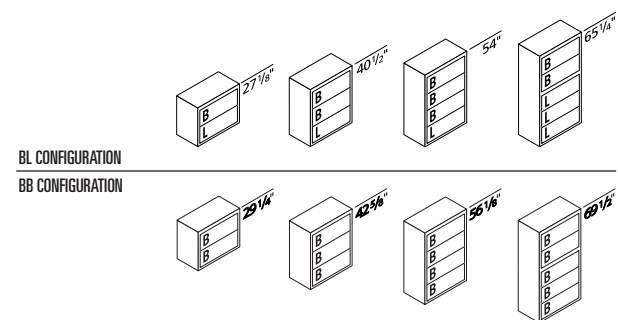

## Built to last, Check it out!

**1** Corner gusset provides additional rigidity



**2** The one piece top has a reinforced channel for additional rigidity and strength

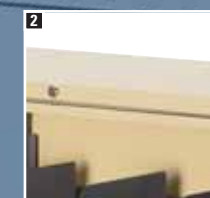

**3** Lock bars on both sides increase security



**4** Removable core cam lock allows for keying changes in the office



**5** File bar slots facilitate letter, legal, or A4 metric hanging file storage



**6** Suspension and safety interlock are integrated for added protection (Actual interlocking components may vary in appearance)



**7** Receding doors have rigid full hat channel to prevent door jamming and provide additional strength

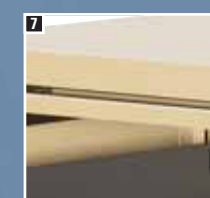

**8** MIG welded corners provide strength and a clean, seamless look

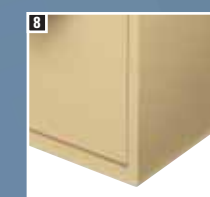

**9** Standard adjustable levelling glides can be levelled from the inside of the cabinet

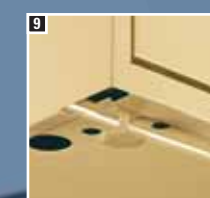

## 9100 Series Lateral Files

These quality built lateral files feature strong MIG welded front corners with many options and standard features. Free up desk space with receding door 'B' openings to accommodate three ring binders. Our two drawer file fits under a 29" worksurface. All files have leveling glides, ensuring that drawers are in easy to open. The interlock system prevents tipping. Removable cam locks are standard.

## 9100 PLUS & 9100 SERIES STORAGE OPTIONS



Ring binder storage in "B" type receding door openings



Side to side EDP hanging data binder storage using two point suspension



Optional front to back hanging bars for letter or legal files



Full depth shelves for legal documents



# 9800 SERIES



## 9800 Series Lateral Files

Solid construction provides long lasting quality and durability. These cabinets accommodate letter, legal and metric file sizes, and are suitable for many types of multimedia storage. The soft touch Hytre™ drawer pull opens easily, and the design of this series complements Globals eO:™ casegoods.



### AVAILABLE DRAWER CONFIGURATIONS

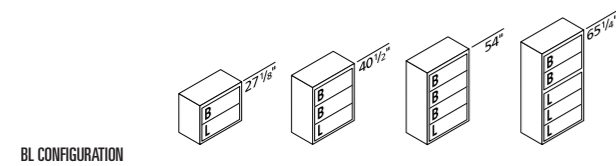

BL CONFIGURATION

### 9800 SERIES STORAGE OPTIONS



Ring binder storage in "B" type receding door openings



Optional front to back hanging bars for letter or legal files



1/2" height drawers ideal for multimedia storage



Accommodates side to side letter, legal and A4 hanging folder sizes



# 9300 & 9300 PLUS SERIES



## 9300 Plus Series Lateral Files

This series has the look of higher end cabinets but at a reduced cost to the end user. Leveling glides keep the file case true, ensuring that drawers are easy to open. Cam locks with removable cores are standard. File bars included. Interlock system prevents tipping by allowing only one drawer to open at a time. Looped full pull design shown above.

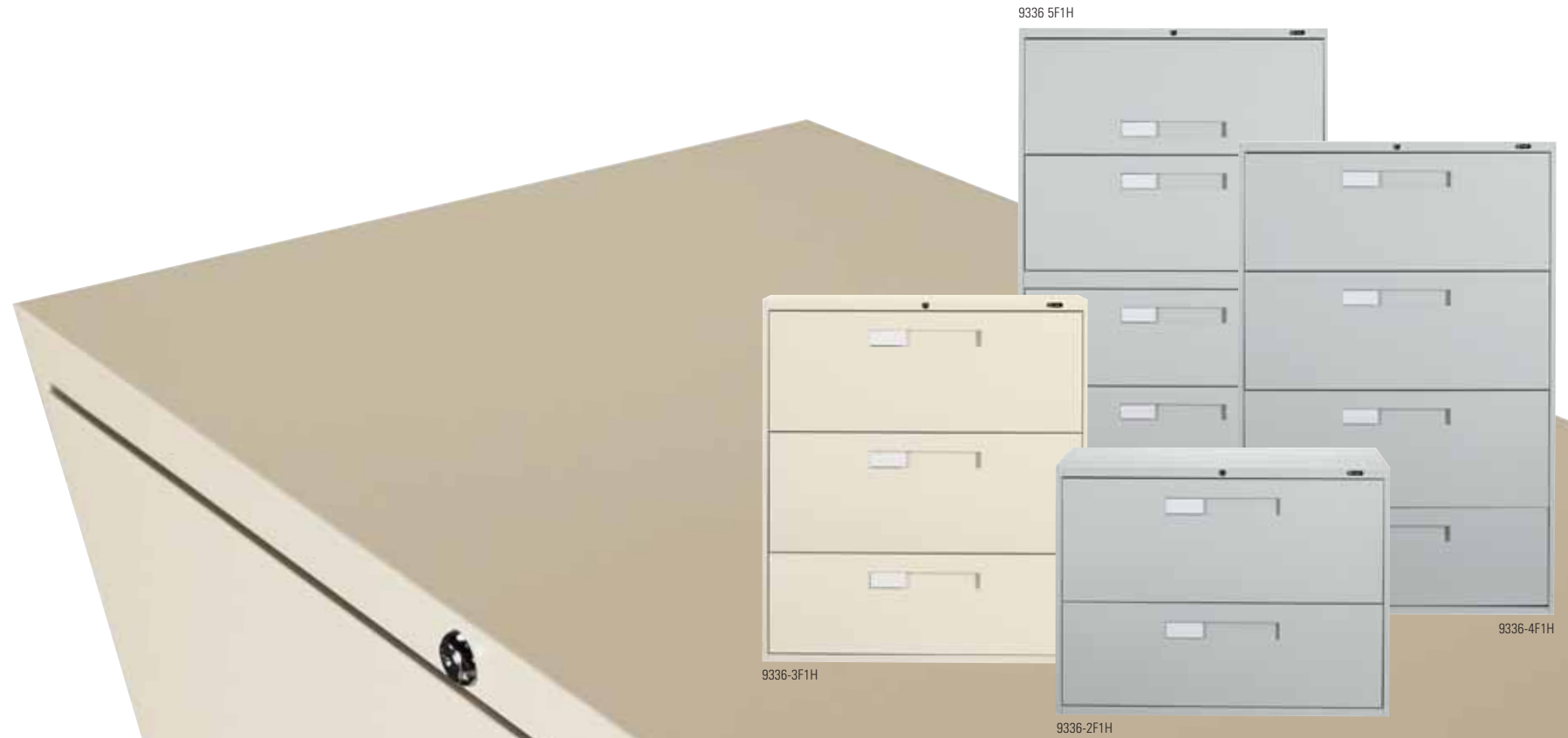

## 9300 Series Lateral Files

Professional lateral file capability at an economical price available with fixed or receding drawer fronts. Solid construction delivers a cabinet with quality and durability. A variety of great features are offered including EDP and ring binder capabilities, all with the flexibility of three file widths. Central core removable cam locks are standard. Interlock system prevents tipping. Center pull design shown above.

### AVAILABLE DRAWER CONFIGURATIONS

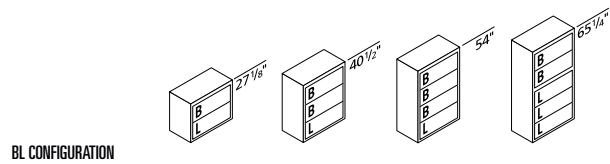

BL CONFIGURATION

### 9300 & 9300 PLUS SERIES STORAGE FEATURES AND OPTIONS



Ring binder storage in "B" type receding door openings



Side to side EDP hanging data binder storage using two point suspension



Front to back hanging bars for letter or legal files



Optional laminate top



# HOTELING LATERAL FILES



# MOBILE STORAGE



9136P-3FSH

## 9100 Plus Series Hoteling Laterals

When multi-user storage is required with additional security, Global has the answer. This alternative office concept is ideal for shared workspaces. Individually keyed cam locks with removable cores in each drawer secure documents. The steel panel between each drawer creates additional security and privacy. Fixed front drawers are standard except for the receding top opening of the five high drawer model.



## File Taxi®

An innovative, alternative office solution meeting the needs of the ever-changing office. It features two box drawers with pencil tray and divider plate, 12" file drawer with full suspension, four swivel casters, receding door with fixed shelf and three divider plates. Available in the 9800 and 9100 Plus Series (both shown). Also available without casters to fit under a 29" H worksurface.



## Stagecoach™

Stagecoach™ is compact and mobile to maximize space and storage in any work environment. This series also provides mobile temporary guest seating. Seating, filing and storage – all in one! The rotating casters easily place Stagecoach™ under the worksurface.

### 9100 PLUS SERIES HOTELING FEATURES

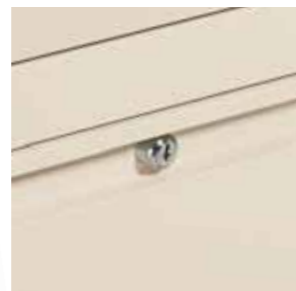

Individually keyed cam locks are standard for each drawer, providing document security



Steel panel between each drawer creates additional security and privacy

### FILE TAXI FEATURES



Ring binder storage in "B" type receding door openings



File drawer allows side to side legal or front to back letter filing

### STAGECOACH FEATURES



Locking ventilated unit accommodates purses, shoes, gym attire etc.



Top rail functions as a backrest support and handle



# END TAB FILES



# PEDESTALS

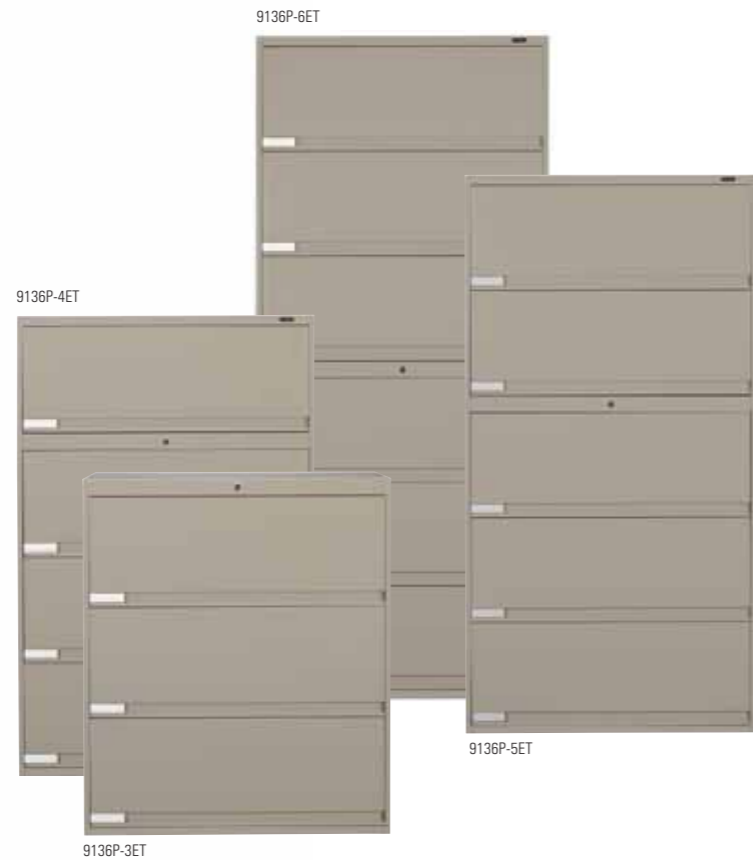

## End Tab Files

End Tab Filing has taken on a much more important role in today's office. Whether it is a Doctor's, Lawyer's, Accountant's office or business of any kind, document security has become an issue. This is a result of the HIPPA Act and the PIPEDA Act. All personal information now must be under lock & key according to these new government regulations. Global's End Tab Filing provides the security that you demand, in a variety of heights, in our easy to access 9100 Plus Series.



## E & G Series Pedestals

These versatile file pedestals come in two handle-styles and can stand on their own or support worksurfaces. Specially designed pulls are soft to the touch and open easily. Available in three heights, with or without casters, and 19", 23", 24", 29" depths.

**E Series:** Pedestals specially designed pulls are soft to the touch and open easily.

**G Series:** File pedestals, with their clean stylish looks, will fit into any environment old or new.

\* 24" model available in @tributes line.

### END TAB FILES FEATURES



Posting shelf for sorting documents (Optional)



Lock located in optional posting shelf position (ADA compliant)

### E SERIES FEATURES



Available with casters



Soft touch Hytrel™ pulls on E series pedestals

### G SERIES FEATURES



23", 24" and 29" depths include side to side legal conversion bars (Not applicable to 19")



Pencil tray is standard in all top box drawers





# PERSONAL STORAGE TOWERS & LOCKERS



9PT5-2B2FL

9PT5-3FR

98T5-3FR

## Personal Storage Towers

This customized tower maximizes required storage for each and everyone of us. It provides the needed security our personal and office items require on a daily basis.

Locker and wardrobe doors are hinged on same side and open away from the worksurface for easier access (can be hinged either left or right). The filing section can be specified with two or three full size files drawers. The top opening can be two box drawers on a full size file drawer. All ball bearing drawer suspensions.

## AVAILABLE CONFIGURATIONS



9PT5-2B2FR

9PT5-2BFR

9PT5-2FR

9PT5-3FR

9100 Plus Series



98T5-2B2FR

98T5-2BFR

98T5-2FR

98T5-3FR

9800 Series

All configurations are available with left side wardrobes. Right side wardrobes are shown above.

## PERSONAL STORAGE TOWER FEATURES



Full height wardrobe section accommodates long coats



High drawer sides eliminates the need for hanging file frames



Standard organizer tray holds personal and office supplies



Three locks in total (1 Key) provides security for each section

Available in 9800 & 9100 Plus Series



# PERSONAL STORAGE TOWERS & LOCKERS



# LOCKERS



9PT5-2B2FL

9PT5-3FR

98T5-3FR

## Personal Storage Towers

This customized tower maximizes required storage for each and everyone of us. It provides the needed security our personal and office items require on a daily basis.

Locker and wardrobe doors are hinged on same side and open away from the worksurface for easier access (can be hinged either left or right). The filing section can be specified with two or three full size file drawers. The top opening can be two box drawers on a full size file drawer. All ball bearing drawer suspensions.

## AVAILABLE CONFIGURATIONS



9PT5-2B2FR 9PT5-2BFR 9PT5-2FR 9PT5-3FR



98T5-2B2FR 98T5-2BFR 98T5-2FR 98T5-3FR

9100 Plus Series

9800 Series

All configurations are available with left side wardrobes. Right side wardrobes are shown above.

\* These configurations also available in 9300 PLUS series.

\* These configurations also available in 9100 Plus series.

## Built to last, Check it out!

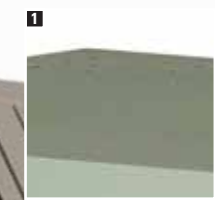

**1** Ventilation

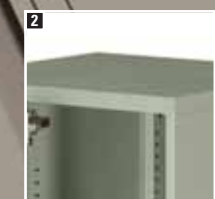

**2** One-piece top adds strength



**3** Corner gusset provides additional rigidity



**4** All doors have 110° European-style hinges



**5** Added reinforcing channel for additional rigidity in top of the cabinet



**6** Adjustable shelf



**7** Pencil tray



**8** Removable core lock allows for key changes in the office. One key opens all compartments.



**9** Full extension file drawer



91P-L518L

91P-L2472R

## Lockers

Cost effective storage for your personal belongings: coats, umbrellas, shoes, and boots all can find a home within this series of personal lockers.

## LOCKER FEATURES



Coat rod



Shelf for hat storage



Adjustable bottom shelf for shoes (available on the 9100P-L2472 R&L series only)



Removable cam locks are standard



# WARDROBES, MULTISTORAGE & BOOKSHELVES



## Wardrobes & Multistorage

Global provides matching storage to all of its series; whether its our best 9100/9100 Plus series, or our 9300/9300 Plus series. We provide different looks and options to meet your changing needs.

**9100 Plus Series:** Two high storage cabinet with one fixed and one adjustable shelf above a three drawer lateral file. Can store two rows of 3-ring binders in the storage compartments. Lock and levelling glides are standard. Choose handles or full pull design.

**9300 CG Cabinet Series:** The cabinets feature a two point locking system with heavy duty shelves (not shown).



## Display Shelves & Economy Storage

Whether it's books or collectibles, these multipurpose units provide an organized solution.

**9300 Series:** Offers 72" high cabinets with one fixed center shelf and three adjustable shelves. 42" high cabinets have one fixed centre shelf and one adjustable shelf. 27 1/8" high cabinets have one fixed shelf. 9300 Plus models have the added beauty and ease of a 'looped full pull.'

### 9100 PLUS & 9800 SERIES FEATURES



One bottom shelf is fixed and the others are adjustable



Hanging file bars included in file drawers

### BOOKSHELF & ECONOMY STORAGE FEATURES



9300 series cabinet doors open 180°

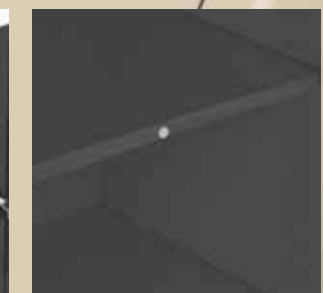

Magnetic stops keep cabinet doors closed



# VERTICAL FILING

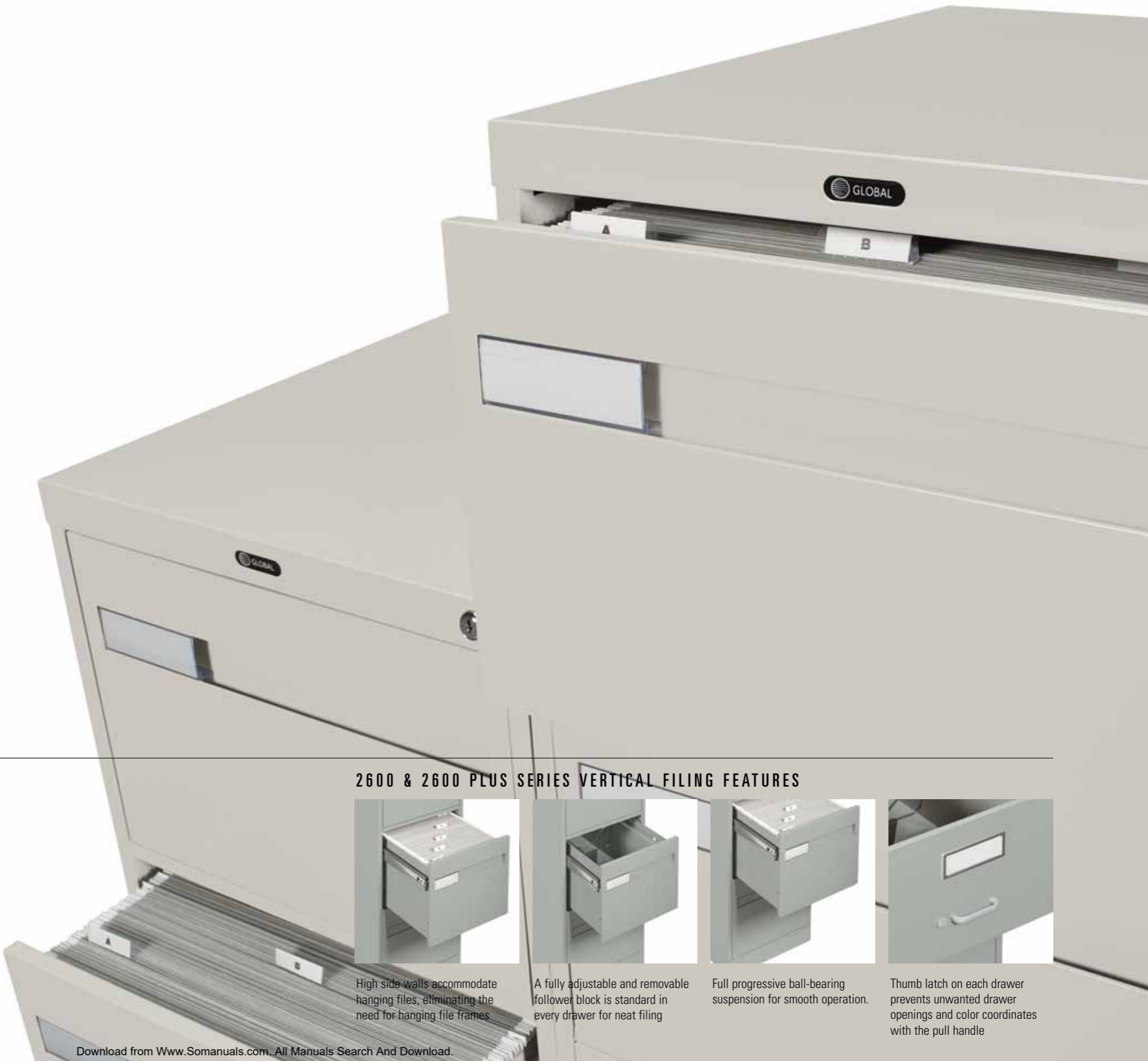

## Vertical Files

When space is limited and you need a space reduced storage solution, Global has a wide selection of vertical filing cabinets to choose from.

**2600 Series:** Economically priced with uncompromising standards. Features removable cam lock, full height side walls with full progressive ball-bearing suspension for smooth operation.

**2600 Plus Series:** High end styling at an economy price. Full-width recessed pull handles. Available in letter or legal file size. Standard lock, full height side walls with full progressive ball-bearing suspension.

**2800 Series:** Files offers 28" deep legal or letter size cabinets with recessed pull. The flush, one piece welded tops enhance their appearance and provide superior strength and rigidity. The full height side walls with full progressive ball-bearing suspension eliminates the need for hanging file frames. A removable cam lock is standard.

**2500 Series:** Available in 2 or 4-drawer configurations. Standard with "d" pull color match label holders.

## AVAILABLE DRAWER CONFIGURATIONS

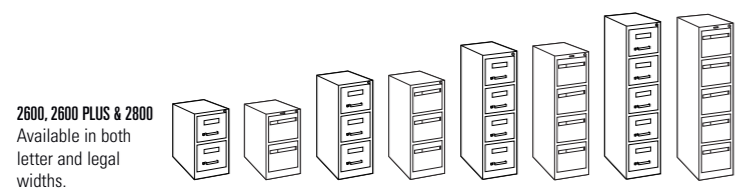

2600, 2600 PLUS & 2800  
Available in both  
letter and legal  
widths.

## 2600 & 2600 PLUS SERIES VERTICAL FILING FEATURES



High side walls accommodate hanging files, eliminating the need for hanging file frames



A fully adjustable and removable follower block is standard in every drawer for neat filing



Full progressive ball-bearing suspension for smooth operation.



Thumb latch on each drawer prevents unwanted drawer openings and color coordinates with the pull handle

Global offers the freedom of color for your filing needs.



### Filing Color Policy:

Global continues to offer color matches for your personalized requirements.

Fileworks™: There is a 10% upcharge on personalized color matches, on orders up to 10 units. There is no upcharge on 11 units or more. A 10% upcharge applies on white finishes for Fileworks products (metallic and mica finishes are not available).

All other filing series products: There is a 10% upcharge on personalized color matches on orders up to 10 units. There is no upcharge on 11 units or more. A 10% upcharge applies on white, metallic and mica finishes. Contact Global for more information.

**Global - Canada**  
The Global Group, 1350 Flint Rd., Downsview ON Canada M3J 2J7  
Sales & Marketing: Tel (1-877) 446-2251  
Customer Service: Fax (800) 361-3182  
Government Customer Service: Fax (416) 739-6319

**Global - U.S.A.**  
17 West Stow Road P.O. Box 562  
Marlton New Jersey U.S.A. 08053  
Tel (856) 596-3390 (800) 220-1900  
Fax (856) 596-2516

**Global - International**  
560 Supertest Road Downsview  
Ontario Canada M3J 2M6  
Tel (416) 661-3660 (800) 668-5870  
Fax (416) 667-1821

**GGI Office Furniture (UK) Ltd.**  
Global Way Darwen  
Lancashire UK BB3 0RW  
Tel +44(0) 1254 778500  
Fax +44(0) 1254 778519

Visit us on the World Wide Web at [www.globaltotaloffice.com](http://www.globaltotaloffice.com)

Offices throughout Canada, United States, United Kingdom, France, Brazil, Australia and Italy. Distribution around the world. A member of the Global Group.

Download from [Www.Somanuals.com](http://Www.Somanuals.com). All Manuals Search And Download.

## Free Manuals Download Website

<http://myh66.com>

<http://usermanuals.us>

<http://www.somanuals.com>

<http://www.4manuals.cc>

<http://www.manual-lib.com>

<http://www.404manual.com>

<http://www.luxmanual.com>

<http://aubethermostatmanual.com>

Golf course search by state

<http://golfingnear.com>

Email search by domain

<http://emailbydomain.com>

Auto manuals search

<http://auto.somanuals.com>

TV manuals search

<http://tv.somanuals.com>