

GoldStar

DVD Player+ Video Cassette Recorder OWNER'S MANUAL

MODEL : GBV441



**Before connecting, operating or adjusting this product,
please read this instruction booklet carefully and completely.**

Safety Precautions



CAUTION
RISK OF ELECTRIC SHOCK
DO NOT OPEN



CAUTION: TO REDUCE THE RISK OF ELECTRIC SHOCK DO NOT REMOVE COVER (OR BACK) NO USER-SERVICEABLE PARTS INSIDE REFER SERVICING TO QUALIFIED SERVICE PERSONNEL.



This lightning flash with arrowhead symbol within an equilateral triangle is intended to alert the user to the presence of uninsulated dangerous voltage within the product's enclosure that may be of sufficient magnitude to constitute a risk of electric shock to persons.



The exclamation point within an equilateral triangle is intended to alert the user to the presence of important operating and maintenance (servicing) instructions in the literature accompanying the product.

WARNING: TO REDUCE THE RISK OF FIRE OR ELECTRIC SHOCK, DO NOT EXPOSE THIS APPARATUS TO RAIN OR MOISTURE.

CAUTION: TO PREVENT ELECTRIC SHOCK, MATCH WIDE BLADE OF PLUG TO WIDE SLOT, FULLY INSERT.

ATTENTION: POUR ÉVITER LES CHOC ÉLECTRIQUES, INTRODUIRE LA LAME LA PLUS LARGE DE LA FICHE DANS LA BORNE CORRESPONDANTE DE LA PRISE ET POUSSER JUSQU'AU FOND.

WARNING: Do not install this equipment in a confined space such as a bookcase or similar unit.

NOTE TO CABLE/TV INSTALLER: This reminder is provided to call the cable TV system installer's attention to Article 820-40 of the National Electric Code (U.S.A.). The code provides guidelines for proper grounding and, in particular, specifies that the cable ground shall be connected to the grounding system of the building, as close to the point of the cable entry as practical.

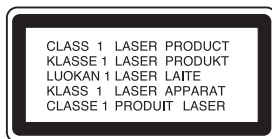

CAUTION:

This DVD+VCR employs a Laser System.

To ensure proper use of this product, please read this owner's manual carefully and retain for future reference. Should the unit require maintenance, contact an authorized service location.

Use of controls, adjustments, or the performance of procedures other than those specified herein may result in hazardous radiation exposure.

To prevent direct exposure to laser beam, do not try to open the enclosure. Visible laser radiation when open. DO NOT STARE INTO BEAM.

CAUTION: The apparatus should not be exposed to water (dripping or splashing) and no objects filled with liquids, such as vases, should be placed on the apparatus.

FCC WARNING: This equipment may generate or use radio frequency energy. Changes or modifications to this equipment may cause harmful interference unless the modifications are expressly approved in the instruction manual. The user could lose the authority to operate this equipment if an unauthorized change or modification is made.

REGULATORY INFORMATION: FCC Part 15

This product has been tested and found to comply with the limits for a Class B digital device, pursuant to Part 15 of the FCC Rules. These limits are designed to provide reasonable protection against harmful interference when the product is operated in a residential installation. This product generates, uses, and can radiate radio frequency energy and, if not installed and used in accordance with the instruction manual, may cause harmful interference to radio communications. However, there is no guarantee that interference will not occur in a particular installation. If this product does cause harmful interference to radio or television reception, which can be determined by turning the product off and on, the user is encouraged to try to correct the interference by one or more of the following measures:

- Reorient or relocate the receiving antenna.
- Increase the separation between the product and receiver.
- Connect the product into an outlet on a circuit different from that to which the receiver is connected.
- Consult the dealer or an experienced radio/TV technician for help.

FCC COMPLIANCE: The responsible party for this product's compliance is:

Marketed and Distributed by LG Electronics U.S.A., Inc.,
1000 Sylvan Avenue, Englewood Cliffs, NJ.
Phone: 1-201-816-2000.



NOTES ON COPYRIGHTS:

It is forbidden by law to copy, broadcast, show, broadcast via cable, play in public, or rent copyrighted material without permission.

This product uses copyright protection developed by Macrovision. Copy protection signals are recorded on some discs. When recording and playing the pictures of these discs on a VCR, picture noise will appear.

This product incorporates copyright protection technology that is protected by method claims of certain U.S. patents and other intellectual property rights owned by Macrovision Corporation and other rights owners. Use of this copyright protection technology must be authorized by Macrovision Corporation, and is intended for home and other limited viewing uses only unless otherwise authorized by Macrovision Corporation. Reverse engineering or disassembly is prohibited.

SERIAL NUMBER: The serial number is found on the back of this unit. This number is unique to this unit and not available to others. You should record requested information here and retain this guide as a permanent record of your purchase.

Model No. _____ GBV441 _____

Serial No. _____

IMPORTANT SAFETY INSTRUCTIONS

CAUTION: PLEASE READ AND OBSERVE ALL WARNINGS AND INSTRUCTIONS IN THIS OWNER'S MANUAL AND THOSE MARKED ON THE PRODUCT. RETAIN THIS BOOKLET FOR FUTURE REFERENCE.

This product has been designed and manufactured to assure personal safety. Improper use can result in electric shock or fire hazard. The safeguards incorporated in this product will protect you if you observe the following procedures for installation, use, and servicing.

This product does not contain any parts that can be repaired by the user.

DO NOT REMOVE THE CABINET COVER, OR YOU MAY BE EXPOSED TO DANGEROUS VOLTAGE. REFER SERVICING TO QUALIFIED SERVICE PERSONNEL ONLY.

- 1. Read these instructions.** - All these safety and operating instructions should be read before the product is operated.
- 2. Keep these instructions.** - The safety, operating and use instructions should be retained for future reference.
- 3. Heed all warnings.** - All warnings on the product and in the operating instructions should be adhered to.
- 4. Follow all instructions.** - All operating and use instructions should be followed.
- 5. Do not use this product near water.** - For example: near a bath tub, wash bowl, kitchen sink, laundry tub, in a wet basement; or near a swimming pool; and other areas located near water.
- 6. Clean only with dry cloth.** - Unplug this product from the wall outlet before cleaning. Do not use liquid cleaners.
- 7. Do not block any ventilation openings. Install in accordance with the manufacturer's instructions.** - Slots and openings in the cabinet are provided for ventilation and to ensure reliable operation of the product and to protect it from over-heating. The openings should never be blocked by placing the product on a bed, sofa, rug or other similar surface. This product should not be placed in a built-in installation such as a bookcase or rack unless proper ventilation is provided or the manufacturer's instructions have been adhered to.
- 8. Do not install near any heat sources such as radiators, heat registers, stoves, or other apparatus (including amplifiers) that produce heat.**
- 9. Do not defeat the safety purpose of the polarized or grounding-type plug.** A polarized plug has two blades with one wider than the other. A grounding type plug has two blades and a third grounding prong. The wide blade or the third prong are provided for your safety. If the provided plug does not fit into your outlet, consult an electrician for replacement of the obsolete outlet.
- 10. Protect the power cord from being walked on or pinched particularly at plugs, convenience receptacles, and the point where they exit from the product.**
- 11. Only use attachments/accessories specified by the manufacturer.**
- 12. Use only with the cart, stand, tripod, bracket, or table specified by the manufacturer, or sold with apparatus. When a cart is used, use caution when moving the cart/product combination to avoid injury from tip-over.**
- 13. Unplug this product during lightning storms or when unused for long periods of time.**
- 14. Refer all servicing to qualified service personnel. Servicing is required when the product has been damaged in any way, such as power-supply cord or plug is damaged, liquid has been spilled or objects have fallen into the product, the product has been exposed to rain or moisture, does not operate normally, or has been dropped.**



Table of Contents

Introduction

Safety Precautions	2
IMPORTANT SAFETY INSTRUCTIONS	3
Table of Contents	4
Before Use	5-6
Playable Discs	5
Precautions	6
Notes on Discs	6
About Symbols	6
Selecting the Viewing Source	6
Front Panel Controls	7
Display Window	8
Remote Control	9
Connections Panel	10

Preparation

Connections	11-13
Connecting Antenna/Cable TV to DVD+VCR	11
Basic TV Connections	12
Optional, Preferred TV Connections	12-13
VCR Operation Setup	14-16
On-Screen Display (OSD)	14
On-Screen Menus Setup	14
VCR Setup Menu Options	15
Channel Selection	15
Setting the Clock	16
DVD Operation Setup	17-20
General Explanation	17
On-Screen Display	17
Initial Settings	18-20
• <i>General Operation</i>	18
• <i>Language</i>	18
• <i>Picture</i>	18
• <i>Progressive Scan</i>	18
• <i>Sound</i>	19
• <i>Others</i>	19
• <i>Parental Control</i>	20

Operation

VCR Operation	21-26
Normal Playback	21
Special Effect Playbacks	21
• <i>Search</i>	21
• <i>Still Picture and Frame-by-Frame Playback</i>	21
• <i>Slow Motion</i>	21
• <i>CM SKIP (Commercial Skip)</i>	21
Normal Recording	22
Timer Recording	22-23
Instant Timer Recording	24
Dubbing and Editing	24
Copying from DVD to VCR	24
VHS Hi-Fi Stereo System/MTS Broadcast	25
Tape Counter Memory Feature	26
Additional Information	26
DVD Operation	27-29
Playing DVDs	27
General Features	27-29
• <i>Selecting other TITLES</i>	27
• <i>Selecting other CHAPTERS</i>	27
• <i>Slow Motion</i>	27

• <i>Still Picture and Frame-by-Frame Playback</i>	28
• <i>Search</i>	28
• <i>Random</i>	28
• <i>Repeat</i>	28
• <i>Repeat A-B</i>	28
• <i>Time Search</i>	28
• <i>3D Surround</i>	28
• <i>Zoom</i>	28
• <i>Marker Search</i>	29
• <i>Changing Video Mode</i>	29
Special DVD Features	29
• <i>Checking the contents of DVD Video discs: . . . Menus</i>	29
• <i>Title Menu</i>	29
• <i>Disc Menu</i>	29
• <i>Camera Angle</i>	29
• <i>Changing the Audio Language</i>	29
• <i>Subtitle</i>	29
Audio CD and MP3/WMA Disc Operation	30-31
Playing Audio CDs and MP3/WMA Discs	30
MP3/WMA Recording Notes	30
• <i>Pause</i>	31
• <i>Selecting other Tracks</i>	31
• <i>Repeat Track/ All/ Off</i>	31
• <i>Search</i>	31
• <i>Random</i>	31
• <i>Repeat A-B</i>	31
• <i>3D Surround</i>	31
• <i>Changing the Audio Channel</i>	31
JPEG File Operation	32
Viewing JPEG Files on a Disc	32
• <i>Selecting other JPEG Files</i>	32
• <i>Still Picture</i>	32
• <i>To flip the picture</i>	32
• <i>To rotate picture</i>	32
• <i>Notes on JPEG Files</i>	32
Programmed Playback	33
Programmed Playback with Audio CDs and MP3/WMA Discs	33
• <i>Repeat Programmed Tracks</i>	33
• <i>Erasing a Track from the Program List</i>	33
• <i>Erasing the Complete Program List</i>	33

Reference

Controlling Your TV with the Supplied Remote ..	34
Troubleshooting	35-36
Language Code List	37
Country Code List	38
Specifications	39
Warranty	Back Cover

About the symbols for instructions



 Indicates hazards likely to cause harm to the unit itself or other material damage.

 Indicates special operating features on this unit.

 Indicates tips and hints for making the task easier.

Before Use

Playable Discs

	DVD (8 cm/12 cm disc)
	Audio CD (8 cm/12 cm disc)

In addition, this unit can play , Kodak Picture CDs DVD+R/RW, DVD-R/RW and CD-Rs or CD-RWs that contain audio titles, MP3, JPEG or WMA files.

Notes

- Depending on the conditions of the recording equipment or the CD-R/RW (or DVD±R/RW) disc itself, some CD-R/RW (or DVD±R/RW) discs cannot be played on the unit.
- The unit cannot play discs that contain data other than MP3 and CD-DA data.
- Do not attach any seal or label to either side (the labeled side or the recorded side) of a disc.
- Do not use irregularly shaped CDs (e.g., heart-shaped or octagonal). The unit may malfunction.

Notes on DVDs

Some playback operations of DVDs may be intentionally fixed by software manufacturers. As this unit plays DVDs according to disc content designed by the software manufacturer, some playback features of the unit may not be available or other functions may be added. Refer also to the instructions supplied with the DVDs. Some DVDs made for business purposes may not be played on the unit.

Regional code of this DVD+VCR and DVDs

This DVD+VCR is designed and manufactured for playback of Region 1 encoded DVD software. The region code on the labels of some DVD discs indicate which type of DVD+VCR can play those discs. This unit can play only DVD discs labeled 1 or ALL. If you try to play any other discs, the message "Check Regional Code" will appear on the TV screen. Some DVD discs may not have a region code label even though their playback is prohibited by area limits.



Note on DTS-encoded CDs

When playing DTS-encoded CDs, excessive noise may be heard from the analog stereo output. To avoid possible damage to the audio system, turn down the volume before playing back such discs, adjust the volume gradually, and keep the volume level low. To enjoy DTS Digital Surround™ playback, an external 5.1 channel Digital Surround™ decoder system must be connected to the digital output of the unit.

Disc-Related Terms

Title (DVD only)

The main film content or accompanying feature content or music album.

Each title is assigned a title reference number enabling you to locate it easily.

Chapter (DVD only)



Sections of a picture or a musical piece that are smaller than titles. A title is composed of one or several chapters. Each chapter is assigned a chapter number to enable you to locate the chapter you want. Depending on the disc, the DVD may not be divided into chapters.

Track (Audio CD only)

Sections of a musical piece on an audio CD. Each track is assigned a track number, enabling you to locate the track you want.

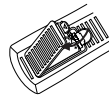
Remote Control Battery Installation



Detach the battery cover on the rear of the remote control, and insert two AAA batteries with  and  aligned correctly.

Caution

Do not mix old and new batteries. Never mix different types of batteries (standard, alkaline, etc.).

Remote Control Operating Range

Point the remote control at the remote sensor and press the buttons.

- **Distance:** About 23 ft (7 m) from the front of the remote sensor
- **Angle:** About 30° in each direction of the front of the remote sensor

IMPORTANT NOTE:

SPENT OR DISCHARGED BATTERIES MUST BE RECYCLED OR DISPOSED OF IN A SAFE MANNER IN COMPLIANCE WITH ALL APPLICABLE LAWS. FOR DETAILED INFORMATION, CONTACT YOUR LOCAL COUNTY SOLID WASTE AUTHORITY.

Manufactured under license from Dolby Laboratories. "Dolby", "Pro Logic" and the double-D symbol are trademarks of Dolby Laboratories.

DTS and DTS Digital Out are trademarks of Digital Theater Systems, Inc.

Before Use (Continued)

Precautions

Handling the unit

When shipping the unit

The original shipping carton and packing materials come in handy. For maximum protection, re-pack the unit as it was originally packaged at the factory.

When setting up the unit

The picture and sound of a nearby TV, VCR, or radio may be distorted during playback. In this case, position the unit away from the TV, VCR, or radio, or turn off the unit after removing the disc.

To keep the surface clean

Do not use volatile liquids, such as insecticide spray, near the unit. Do not leave rubber or plastic products in contact with the unit for a long period of time. They will leave marks on the surface.

Cleaning the unit

To clean the cabinet

Use a soft, dry cloth. If the surfaces are extremely dirty, use a soft cloth lightly moistened with a mild detergent solution. Do not use strong solvents such as alcohol, benzene, or thinner, as these might damage the surface of the unit.

To obtain a clear picture

The DVD+VCR is a high-tech, precision device. If the optical pick-up lens and disc drive parts are dirty or worn, the picture quality will be poor.

Regular inspection and maintenance are recommended after every 1,000 hours of use. (This depends on the operating environment.)

For details, please contact your nearest dealer.

Notes on Discs

Handling discs

Do not touch the playback side of the disc. Hold the disc by the edges so that fingerprints will not get on the surface. Do not stick paper or tape on the disc.

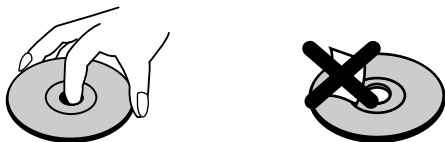

Storing discs

After playing, store the disc in its case. Do not expose the disc to direct sunlight or sources of heat, or leave it in a parked car exposed to direct sunlight, as there may be a considerable temperature increase inside the car.

Cleaning discs

Fingerprints and dust on the disc can cause poor picture quality and sound distortion. Before playing, clean the disc with a clean cloth. Wipe the disc from the center out.

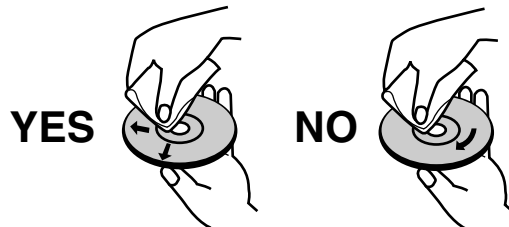

Do not use strong solvents such as alcohol, benzene, thinner, commercially available cleaners, or anti-static spray intended for older vinyl records.

About Symbols

About the symbol display

"" may appear on the TV screen during operation. This icon means the function explained in this owner's manual is not available on that specific DVD video disc.

About the disc symbols for instructions

A section whose title has one of the following symbols are applicable only to those discs represented by the symbol.

-  DVD
-  Audio CDs.
-  MP3 Discs.
-  WMA Discs.
-  JPEG Files.

Selecting the Viewing Source

You must select one of your output sources (DVD or VCR) to view on the TV screen.

- **If you want to view DVD deck output source:** Press DVD on the remote or DVD/VCR on the front panel until DVD indicator in the display window lights and output source of DVD deck is viewed on the TV screen.
- **If you want to view VCR deck output source:** Press VCR on the remote or DVD/VCR on the front panel until VCR indicator in the display window lights and output source of VCR deck is viewed on the TV screen.

Notes

- If you insert a disc while the DVD+VCR is in the VCR mode, the DVD+VCR will switch to DVD mode automatically.
- If you insert a cassette tape without an erasure prevention tab while the DVD+VCR is in the DVD mode, the DVD+VCR will switch to VCR mode automatically.

Front Panel Controls

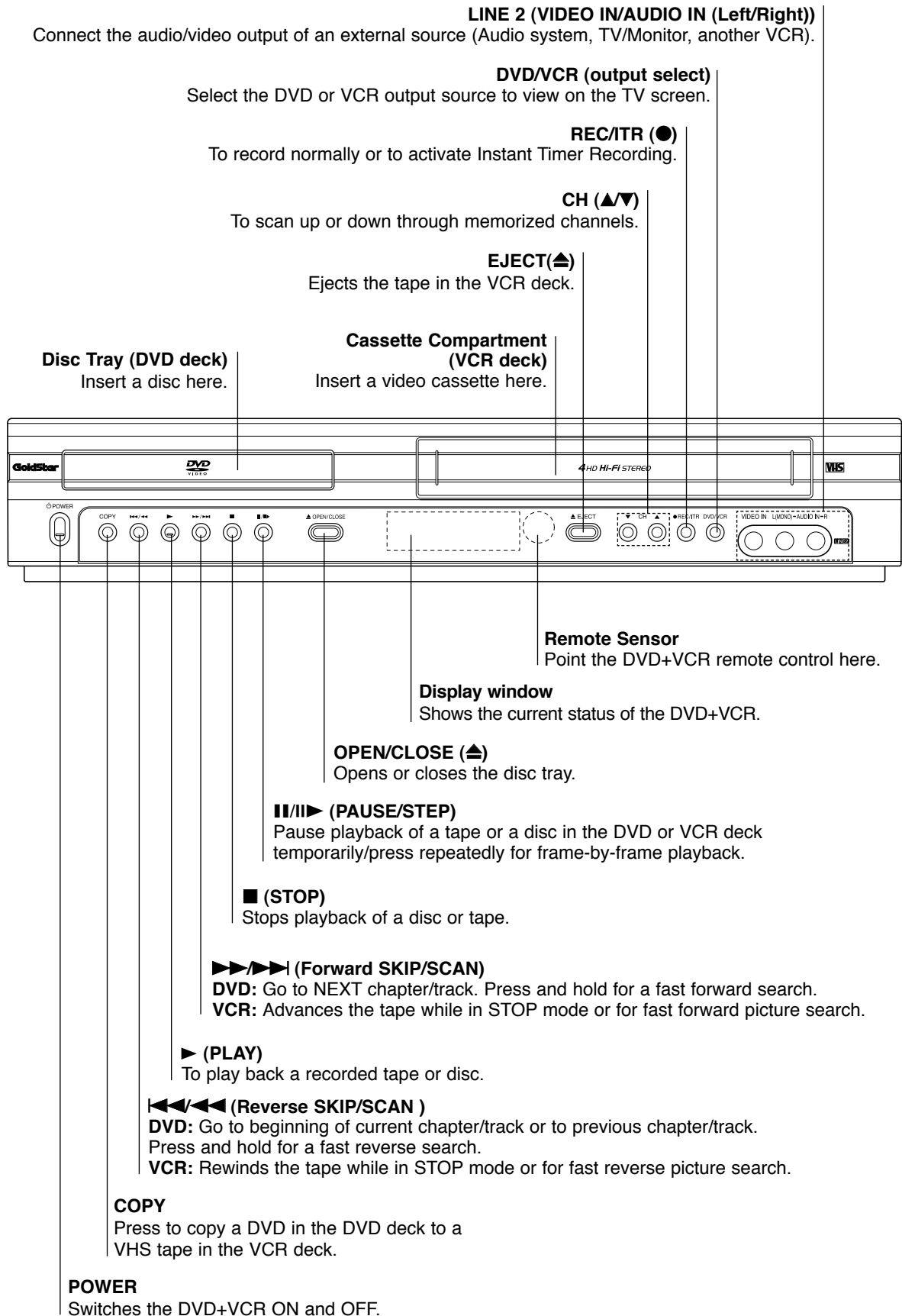

Display Window

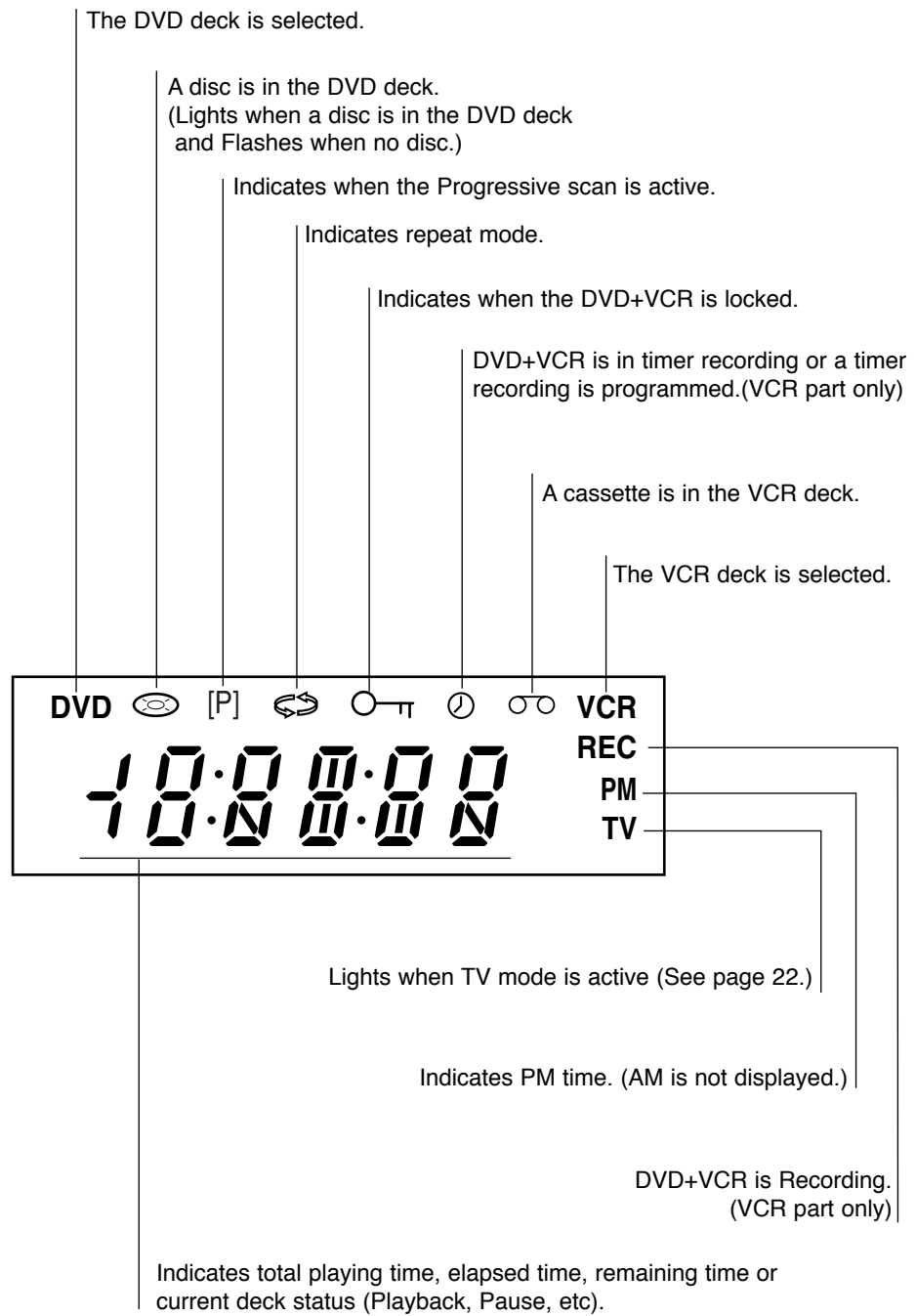

Remote Control

- POWER**
Turns DVD+VCR ON and OFF.
- DVD**
Select the DVD+VCR function mode to DVD.
- VCR**
Select the DVD+VCR function mode to VCR.
- INPUT**
Selects the VCR deck's source (Tuner, LINE 1, or LINE 2).
- 0-9 numerical buttons**
Selects numbered options in a menu. Selects TV's channel.
- TV/VCR**
To view channels selected by the VCR tuner or by the TV tuner.
- DISPLAY, CLK/CNT**
Accesses On-Screen Display. Switches between the clock, tape counter and tape remaining modes on the display.
- SETUP, MENU**
Accesses or removes DVD Setup menu and VCR menu.
- ◀ ▶ ▲ ▼ (left/right/up/down)**
Selects menu options.
- CH/TRK(▲+ / ▼-)** : Selects VCR channels. Adjusts manually the tape's picture onscreen.
- ENTER**
Confirms menu selections.
- DISC MENU**
Accesses menu on a DVD disc.
- RETURN (↶)**
Removes the menu.
- AUDIO**
Selects an audio language (DVD) or an audio channel (CD).
- SUBTITLE**
Selects a subtitle language.
- ANGLE**
Selects a DVD camera angle, if available.
- ZOOM**
Enlarges DVD video image.

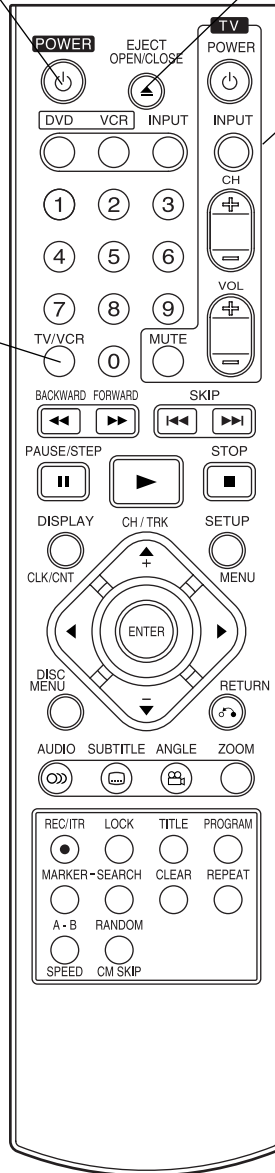

- EJECT, OPEN/CLOSE**
 - Opens and closes the disc tray.
 - Ejects the tape in the VCR deck.
- TV Control Buttons**
 - **POWER**: Switches TV ON and OFF.
 - **INPUT**: Selects the TV's source.
 - **CH +/-**: Selects TV's channel.
 - **VOL +/-**: Adjusts TV's volume.
 - **MUTE**: Turns on or off TV sound.
- BACKWARD / FORWARD (◀▶)**
 - DVD: Search backward or forward.
 - VCR: Rewinds/Advances the tape during the STOP mode, for fast reverse/forward picture search.
- SKIP (◀◀ / ▶▶)**
Go to next chapter or track. Returns to beginning of current chapter or track or go to previous chapter or track.
- PAUSE/STEP (||)**
Pause playback or recording temporarily, press again to exit pause mode. press repeatedly for frame-by-frame playback.
- ▶ (PLAY)**
Starts playback.
- STOP (■)**
Stops playback or recording.
- REC/ITR (●)**
Starts recording. Press repeatedly to set the recording time.
- LOCK**
Locks/unlocks front panel buttons.
- TITLE**
Displays the disc's Title menu, if available.
- PROGRAM**
Accesses or removes Program menu.
- MARKER**
Marks any point during playback.
- SEARCH**
Displays Marker Search menu.
- CLEAR**
Removes a mark on the Marker Search menu.
- REPEAT**
Repeat chapter, track, title or all.
- A-B/SPEED**
 - Repeats sequence between two points (A and B).
 - Selects recording speed.
- RANDOM/CM SKIP**
 - Plays tracks in random order.
 - Fast forwards picture search through 30 seconds of recording.

LOCK

The Lock feature disables the front panel buttons to prevent children from tampering with the DVD+VCR. Simply press LOCK on the remote control to toggle this feature on and off.

Connections Panel

VCR IN LINE 1 (VIDEO IN/AUDIO IN (Left/Right))

Connect the audio/video output of an external source (Audio system, TV/Monitor, Another VCR).

DVD/VCR OUT (VIDEO/AUDIO (Left/Right))

Connect to a TV with video and audio inputs.

COMPONENT/PROGRESSIVE SCAN VIDEO OUT (Y Pb Pr) (DVD OUT)

Connect to a TV with Y Pb Pr inputs.

AUDIO OUT (Left/Right) (DVD OUT)

Connect to a TV, amplifier, receiver, or stereo system.

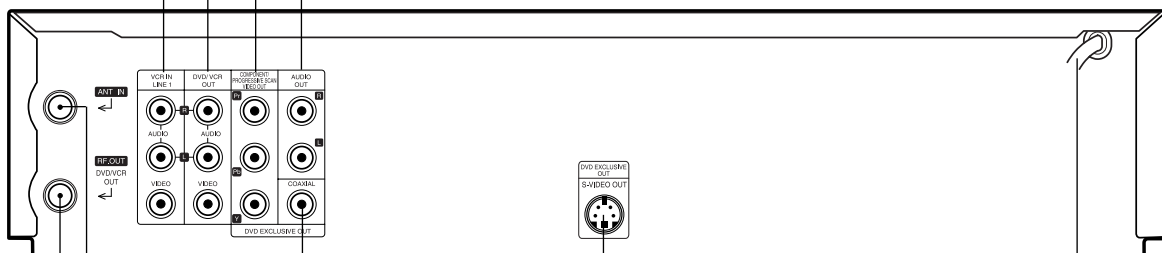

AC Power Cord
Plug into the power source
(AC 120V, 60 Hz).

S-VIDEO OUT (DVD OUT)

Connect to a S-Video Input on TV.

DIGITAL AUDIO OUT (COAXIAL) (DVD OUT)

Connect to digital (coaxial) audio equipment.

ANT.IN (ANTENNA INPUT)

Connect the VHF/UHF/CATV antenna to this terminal.

RF. OUT (DVD/VCR OUT)

Connect to a TV with RF coaxial inputs.



Do not touch the inner pins of the jacks on the rear panel. Electrostatic discharge may cause permanent damage to the unit.

Connections

Tips

- Depending on your TV and other equipment you wish to connect, there are various ways you could connect the DVD+VCR. Use connections described on pages 11-13.
- Please refer to the manuals of your TV, VCR, Stereo System or other devices as necessary to make the best connections.
- For better sound reproduction, connect the DVD+VCR's DVD/VCR AUDIO OUT jack to the audio in jacks of your amplifier, receiver, stereo or audio/video equipment. See *Optional, Preferred TV Connections* on pages 12-13.

Caution

- Make sure the DVD+VCR is connected directly to the TV. Tune the TV to the correct video input channel.
- Do not connect the DVD+VCR's DVD/VCR AUDIO OUT jack to the phono in jack (record deck) of your audio system.
- Do not connect your DVD+VCR via your VCR. The DVD image could be distorted by the copy protection system.

Connecting Antenna/Cable TV to DVD+VCR

- 1 Disconnect the antenna leads from the rear of the TV.
- 2 Identify the type of cable from your antenna. If it is a round cable as illustrated, it is a 75 ohm coaxial antenna cable. This cable will connect directly to the jack marked ANT.IN on your DVD+VCR.

Tip

If your antenna lead wire is a flat type antenna cable, connect it to an Antenna Adapter (300-ohm to 75-ohm) (not supplied) and slip the Adapter onto the ANT.IN jack. The Adapter does not screw on to the DVD+VCR, it just slips over the jack.

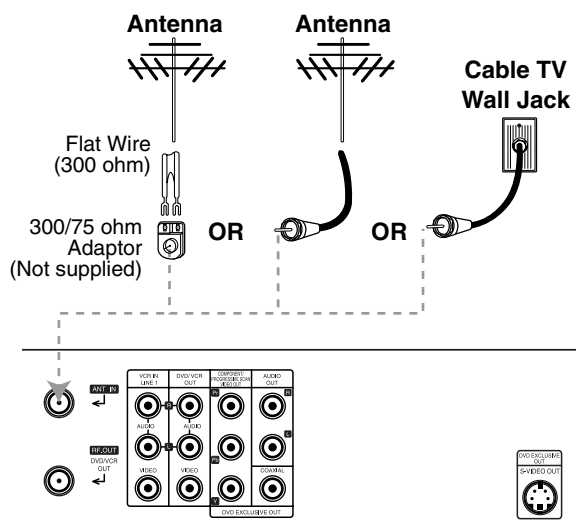

Rear of DVD+VCR

Without Cable Box

If your cable wire is connected to your TV without a converter or descrambler box, unscrew the wire from your TV and attach it to the ANT.IN jack on the DVD+VCR. Use the supplied round coaxial cable to connect between the DVD+VCR's RF.OUT jack and the 75 ohm antenna input jack on the TV. With this connection, you can receive all midband, super band, and hyperband channels.

With Cable Box

If a converter is required in your cable system, follow the instruction below:
The cable hookup permits both TV and DVD+VCR operation.

To view or record CATV channel

- 1 Tune the TV to the DVD+VCR output channel (CH 3 or 4).
- 2 Set the DVD+VCR channel selector to the output channel of the Cable Converter box by using the CH/TRK (▲/▼) or number (0-9) of your DVD+VCR. (Example: CH3)
- 3 Select the channel to view at the Cable Converter Box.

Notes

- With this connection, you CANNOT record one program while viewing another.
- If you are using a cable box to tune channels, it is not necessary to do Auto Channel Programming as indicated on page 15.

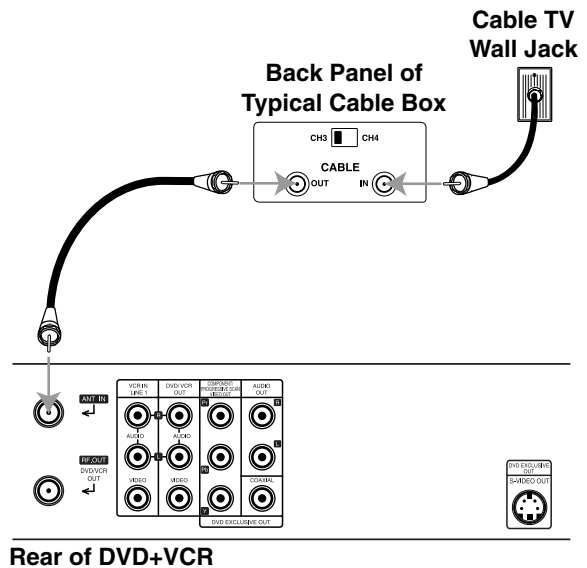

Rear of DVD+VCR

Connections (Continued)

Basic TV Connections

- Make one of the following connections, depending on the capabilities of the equipment to be connected.

RF coaxial connection

Connect the RF.OUT jack on the DVD+VCR to the antenna in jack on the TV using the 75-ohm Coaxial Cable supplied (**R**).

Note

If you use this connection, tune the TV to the DVD+VCR's RF output channel (CH 3 or 4).

How to set the DVD+VCR's RF output channel

1. Set the TV to the VCR channel (3 or 4) depending upon the selected channel.
2. When the DVD+VCR is turned off, press and hold CH (▼/▲) on the front panel for more than five seconds. It will turn itself on and "RF03" or "RF04" appears in the display window.
3. Press CH (▼/▲) on the front panel or CH/TRK (▲/▼) on the remote control to change the RF output channel (CH 03 or CH 04).
4. Turn off the DVD+VCR.

Audio/Video connection

1. Connect the DVD/VCR VIDEO OUT jack on the DVD+VCR to the video in jack on the TV using the video cable supplied (**V**).
2. Connect the Left and Right DVD/VCR AUDIO OUT jacks on the DVD+VCR to the audio left/right in jacks on the TV (**A1**) using the supplied audio cables.

Note

If you use this connection, set the TV's source selector to VIDEO.

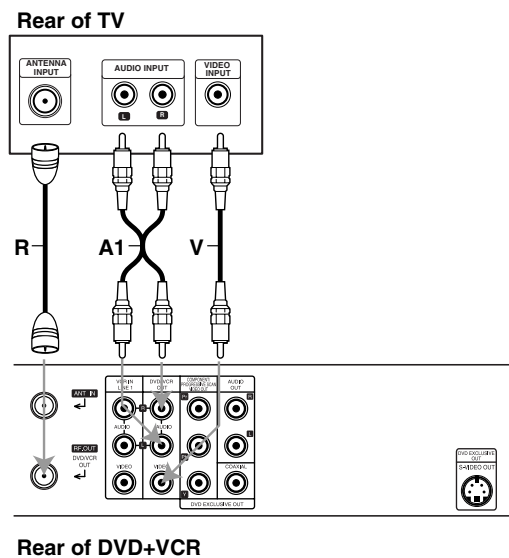

Optional, Preferred TV Connections

Note

You can ONLY watch and listen to DVD playback through the connections shown below.

S-Video connection

1. Connect the S-VIDEO OUT jack on the DVD+VCR to the S-Video in jack on the TV using the optional S-Video cable (**S**).
2. Connect the Left and Right AUDIO OUT jacks of the DVD+VCR to the audio left/right in jacks on the TV using the supplied audio cables (**A2**).

Component Video (Color Stream®) / Progressive Scan (ColorStream® pro) connection

- If your television is a high-definition or "digital ready" television, you may take advantage of the DVD+VCR's progressive scan output for the highest video resolution possible.
- If your TV does not accept the Progressive Scan format, the picture will appear scrambled if you try Progressive Scan on the DVD+VCR.

1. Connect the COMPONENT/PROGRESSIVE SCAN VIDEO OUT jacks on the DVD+VCR to the corresponding in jacks on the TV using an optional Y Pb Pr cable (**C**).
2. Connect the Left and Right AUDIO OUT jacks of the DVD+VCR to the audio left/right in jacks on the TV (**A2**) using the supplied audio cables.

Notes

- Set the Progressive Scan to "On" on the setup menu for progressive scan signal, see page 18.
- When you use Component Video signal, set the Progressive Scan to "Off" on the setup menu.
- Progressive scan does not work with the analog video connections (yellow VIDEO OUT jack).

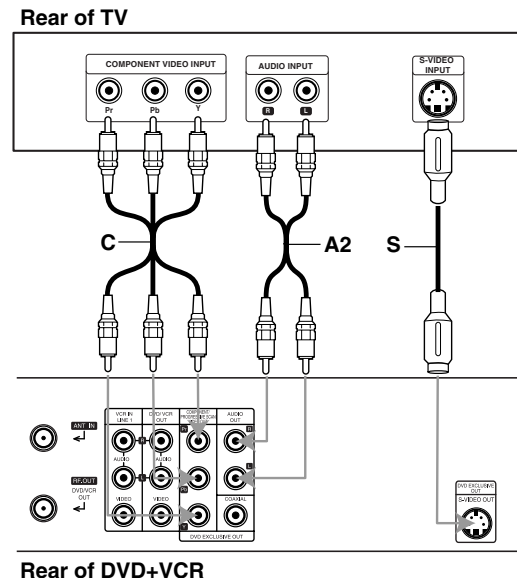

Connections (Continued)

Optional, Preferred TV Connections

Note

You can ONLY listen to DVD playback using COAXIAL (X) and AUDIO OUT (A2) connections. The tuner and VCR will still be heard through the RF.OUT (R) or DVD/VCR AUDIO OUT (A1) jack. (See page 12.)

Connecting to an amplifier equipped with two channel analog stereo or Dolby Surround

Connect the Left and Right AUDIO OUT (or DVD/VCR AUDIO OUT) jacks on the DVD+VCR to the audio left and right in jacks on your amplifier, receiver, or stereo system using the audio cables (for A1 or A2 connection) supplied.

Connecting to an amplifier equipped with two channel digital stereo (PCM) or to an Audio/Video receiver equipped with a multi-channel decoder (Dolby Digital™, MPEG 2, or DTS)

1 Connect one of the DVD+VCR's DIGITAL AUDIO OUT jacks (COAXIAL X) to the corresponding in jack on your amplifier. Use an optional digital (COAXIAL X) audio cable.

2 You will need to activate the DVD+VCR's digital output. (See "Digital Audio Output" on page 19).

Digital Multi-channel sound

A digital multi-channel connection provides the best sound quality. For this you need a multi-channel Audio/Video receiver that supports one or more of the audio formats supported by your DVD+VCR (MPEG 2, Dolby Digital and DTS). Check the receiver manual and the logos on the front of the receiver.



Caution:

Due to the DTS Licensing agreement, the digital output will be in DTS digital out when DTS audio stream is selected.

Notes

- If the audio format of the digital output does not match the capabilities of your receiver, the receiver will produce a strong, distorted sound or no sound at all.
- Six Channel Digital Surround Sound via digital connection can only be obtained if your receiver is equipped with a Digital Multi-channel decoder.
- To see the audio format of the current DVD in the on-screen display, press AUDIO.

Rear of DVD+VCR

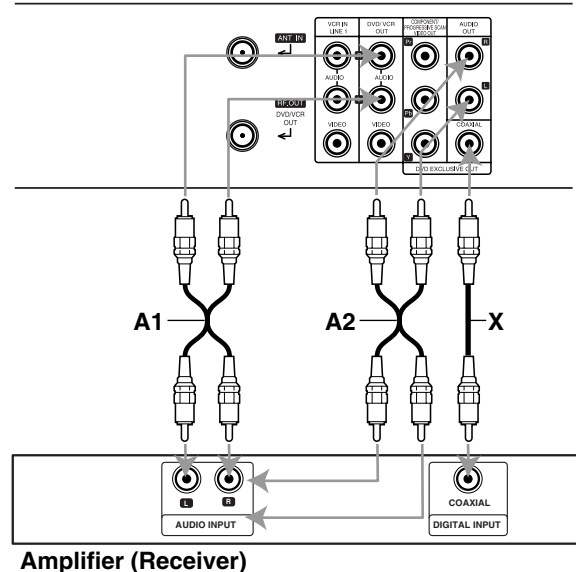

Accessory Audio/Video (A/V) Connections to DVD+VCR

Connect the VCR IN LINE 1 or LINE 2 jacks on the DVD+VCR to the audio/video out jacks on your accessory component, using the optional audio/video cables.

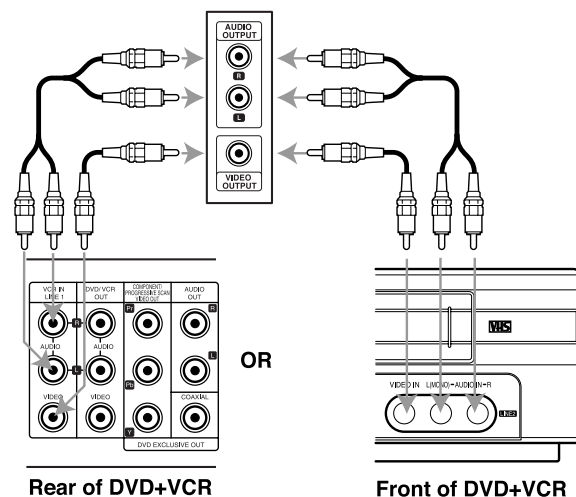
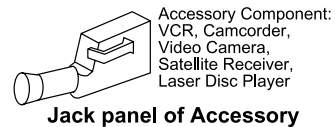

VCR Operation Setup

On-Screen Display (OSD)

Some of these functions will be displayed every time the DVD+VCR is operated.

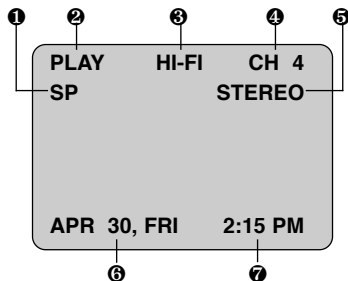

1 TAPE SPEED DISPLAY

Shows the current tape speed.

2 FUNCTION DISPLAY

Indicates the current function.

3 HI-FI DISPLAY

Indicates when this unit is playing back tape recorded with Hi-Fi.

4 CHANNEL DISPLAY

Indicates the selected channel (or LINE1, LINE2).

5 STEREO/SAP DISPLAY (MONO is not displayed)

Shows the type of audio signal received by the VCR tuner.

6 DATE DISPLAY

Shows the current date. (Month/Date/Day of the week format)

7 CLOCK/COUNT/REMAIN DISPLAY

Shows the current time, the tape counter and remaining time on the tape.

Each press of the **ENTER** changes the TV on-screen displays in the following sequence.

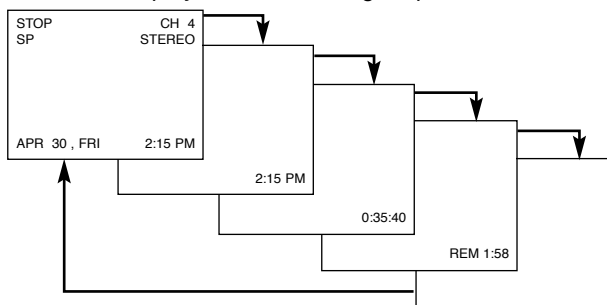

Notes

- Function displays remain on the TV screen for 5 seconds.
- The clock (or tape counter, tape remaining) mode will be displayed until you press **ENTER**.
- The tape counter and the remaining tape length indicator appear only when a cassette is inserted. Also, the remaining tape length indicator appears after any tape operation.

EASY INFORMATION

If the Extended Data Service (XDS) signals are provided along with normal TV signal in your area or during playback of a tape recorded with Extended Data Service (XDS) signals, the station ID, program title, and program details are shown on the TV screen.

When viewing a channel with Extended Data Service (XDS) signals, press **ENTER** and the station ID will appear on the TV screen. Press **ENTER** again and the program details will appear on the TV screen.

When viewing a tape recorded with Extended Data Service (XDS) signals, press **ENTER** twice and the program title and program details will appear on the TV screen.

PROGRAM DETAILS

LENGTH: Indicates the run length of a program.

TIME REMAINING: Indicates the remaining time of a program.

RATING: Indicates the rating of the current program (N/A, G, PG, PG-13, R, NC-17, X and Not Rated). The rating N/A means that the motion picture ratings are not applicable to this program.

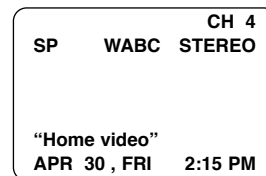

Easy Information Screen
(Station ID)

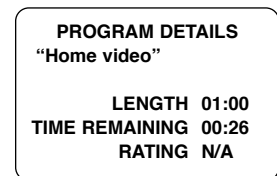

Easy Information Screen
(Program details)

On-Screen Menu Setup

The **SETUP**, clock setting (**CLOCK**), and timer recordings (**PROGRAM**) functions are accessed conveniently with the on-screen menus, that lead you through each step. The following pages describe the on-screen menu selections available.

Menu Selection

Your DVD+VCR allows remote control adjustment of several features.

1 Press **MENU** and the **MAIN** menu will appear.

2 Select the desired menu with **▲/▼** button and then press **ENTER**.

Note

Menus remain on-screen for 3 minutes.

MAIN MENU

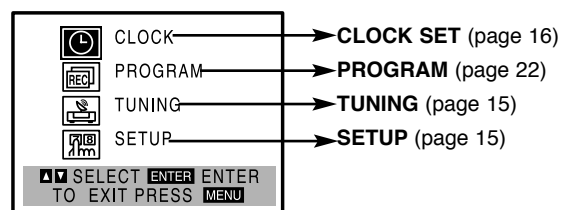

3 Press **MENU** when finished.

VCR Operation Setup (Continued)

VCR Setup Menu Options

- 1 Press **MENU** and the **MAIN** menu will appear.
- 2 Use **▲▼** to select the **SETUP** menu, then press **ENTER**.
The **SETUP** menu will appear.

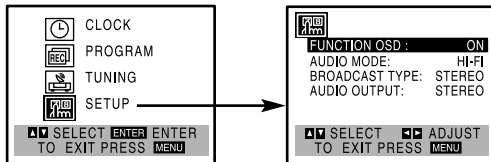

- 3 Use **▲▼** to choose a desired option on the **SETUP** menu. Then use **◀▶** to make adjustments.

FUNCTION OSD

The on-screen display of this DVD+VCR can be turned on or off.

- Use **◀▶** to switch the **FUNCTION OSD** ON or OFF.

AUDIO MODE

The DVD+VCR has two separate audio playback systems, the high quality VHS Hi-Fi system and standard NORMAL mono system. The same audio is generally recorded on both systems. The VHS Hi-Fi system plays on separate (left and right) channels, and the NORMAL system plays monaural sound. The normal track is always played so the cassette can be played on a DVD+VCR that does not have VHS Hi-Fi.

- **AUDIO MODE** can be switched between **HI-FI** and **NORMAL** using **◀▶**.

BROADCAST TYPE (STEREO/SAP/MONO)

Multichannel Television Sound (MTS) carries stereo and/or Second Audio Program (SAP) bilingual signals. Set this display to the desired position when both MTS stereo and SAP signals are received. When only one of the MTS signal is received, the DVD+VCR automatically selects the corresponding receiving mode (Stereo or SAP) regardless of the selected position. For normal operation, the display should be in the **STEREO** position. The DVD+VCR will then record a **STEREO** program when available, and record a **mono** program IF the program is **NOT IN STEREO**.

For weak **STEREO** and/or **SAP** broadcasts, changing the display to **mono** may give clearer sound.

- **BROADCAST TYPE** can be switched between **STEREO**, **SAP**, and **MONO** using **◀▶**.

AUDIO OUTPUT (STEREO/LEFT/RIGHT)

Used during playback [when **AUDIO MODE** (**HI-FI**/**NORMAL**) is in **HI-FI** position] for selecting the audio output signals from the **AUDIO OUT** terminals (L ch and R ch), and **RF.OUT**.

This display setting should normally be left in the **stereo** position, so that when a stereo tape is played, the stereo sound will be heard through the left and right channels. If a mono tape is played and the audio output is set to **stereo**, the same mono sound will be heard from both left and right channels.

- **AUDIO OUTPUT** can be switched between **STEREO**, **LEFT**, and **RIGHT** using **◀▶**.

- 4 Press **MENU** when finished.

Channel Selection

This DVD+VCR is equipped with a frequency synthesized tuner capable of receiving up to 181 channels. These include VHF channels 2-13, UHF channels 14-69 and CATV channels 1-125.

Preparation:

- Connect the DVD+VCR to the desired type of antenna or cable TV system, as shown in Connecting Antenna/Cable TV to DVD+VCR on page 11.

AUTO CHANNEL PROGRAMMING

- 1 Press **MENU** and the **MAIN** menu will appear.
- 2 Use **▲▼** to select the **TUNING** menu, then press **ENTER**.
The **TUNING** menu will appear.

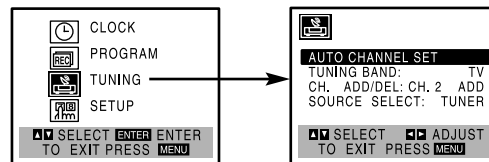

- 3 Use **▲▼** to choose the **SOURCE SELECT** option, then use **◀▶** to select **TUNER**.
Press **◀▶** repeatedly to switch between **TUNER**, **LINE1**, and **LINE2**.
- 4 Press **▲▼** to choose the **AUTO CHANNEL SET** option, then press **◀▶** to set the channel.
 - The tuner will automatically cycle through all available channels (TV/CATV) in the area and place them in the tuner's memory.
 - After the **AUTO CHANNEL SET** is complete, the **TUNING** menu will hide and return to the TV screen automatically.
- 5 Make sure the **TUNING BAND** is set appropriately (**TV** or **CATV**).
 - **TV** : If you are using a standard antenna to receive channels.
 - **CATV** : If you are using basic cable to receive channels.
 - Change the setting of **TUNING BAND** to check the TV channels.
- 6 Use **CH/TRK** (**▲▼**) on the remote control or **CH** (**▼/▲**) on the front panel to cycle the DVD+VCR through the channels in memory.

TO ADD OR ERASE CHANNELS

This feature allows you to add or erase channels from memory manually.

- 1 Use **▲▼** to choose the **CH. ADD/DEL** option on the **TUNING** menu. Use **◀▶** to select a channel to add or erase.
- 2 Use **ENTER** to add or erase the channel. Repeat steps 1 and 2 to add or erase other channels.
- 3 Press **MENU** to return to the TV screen.

VCR Operation Setup (Continued)

Setting the Clock

The DVD+VCR gives you two ways to set the time and date: the Auto Clock Feature or manually. The Auto Clock feature enables the DVD+VCR to set up the clock while the DVD+VCR is turned off.

Things to know before starting

- The clock uses the 12-hour system. (Be sure to set AM and PM correctly.) (AM does not appear.)
- The initial Clock Setting is **JANUARY 1, 2004, 12:00 AM**.

Auto Clock Set

The Auto Clock Set feature is set to ON at the factory. In the ON setting, the DVD+VCR looks for a channel carrying XDS (Extended Data Services) information. XDS updates the clock using the Coordinated Universal Time.

The Auto Clock feature enables the DVD+VCR to set up the clock while the DVD+VCR is turned off.

- 1 Press MENU and the MAIN menu will appear.**
- 2 Use ▲/▼ to choose the CLOCK menu.**
- 2 Press ENTER and the CLOCK menu will appear.**

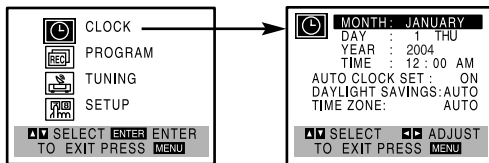

- 3 Use ▼ to choose the AUTO CLOCK SET option.**
Use ◀/▶ to choose ON.
The Auto Clock Set feature is set to ON at the factory. In the ON setting, the DVD+VCR looks for a channel carrying XDS (Extended Data Services) information. XDS updates the clock using the Coordinated Universal Time.
- 4 Use ▼ to choose the DAYLIGHT SAVINGS option.**
Use ◀ or ▶ to choose AUTO, ON, or OFF.
If you choose AUTO, the VCR sets the clock using the DST information broadcast in the signal (channel).
If you choose ON, the VCR adjusts the clock for Daylight Saving Time automatically.
- 5 Use ▼ to choose the TIME ZONE option.**
Use ◀ or ▶ to choose the correct time zone (AUTO, EASTERN, CENTRAL, MOUNTAIN, PACIFIC, ALASKA or HAWAII).
If "AUTO" is selected as the time zone, the VCR sets the clock using the first Coordinated Universal Time information it finds in a broadcast signal.
- 6 Press MENU when finished.**
- 7 Turn off the DVD+VCR and the auto clock set feature sets the time.**

Note

There are cases where the TV station does not send or sends wrong date and/or time information and the DVD+VCR sets the incorrect time.

If this happens we recommend that you set the clock manually.

Manual Clock Set

- 1 Press MENU and the MAIN menu will appear.**
- 2 Use ▲/▼ to choose the CLOCK menu.**
- 2 Press ENTER and the CLOCK menu will appear.**

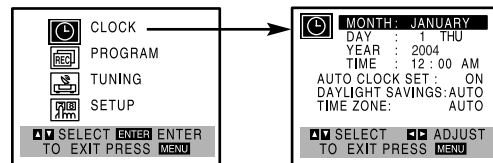

- 3 Use ◀/▶ to choose the month.**
- 4 Use ▼ to choose the DAY option.**
Use ◀/▶ to choose the date.
The day of the week will display automatically.
- 5 Use ▼ to choose the YEAR option.**
Use ◀/▶ to choose the year.
- 6 Use ▼ to choose the TIME option.**
Use ◀/▶ to choose the time.
Press and hold ◀/▶ to advance clock continuously.
- 7 Use ▼ to choose the DAYLIGHT SAVINGS item.**
Use ◀ or ▶ to choose AUTO, ON or OFF.
If you choose AUTO, the VCR sets the clock using the DST information broadcast in the signal (channel).
If you choose ON, the VCR adjusts the clock for Daylight Saving Time automatically.

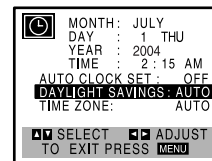

- 8 Press MENU when finished.**

Note

If setting the clock manually, "AUTO CLOCK SET" must be set to "OFF".

If set to "ON", an incorrect date and/or time will be entered again when the DVD+VCR is turned off.

DVD Operation Setup

General Explanation

This manual gives the basic instructions for operating the DVD+VCR. Some DVDs require specific operation or allow only limited operation during playback. When this occurs, the symbol  appears on the TV screen, indicating that the operation is not permitted by the DVD+VCR or is not available on the disc.







On-Screen Display

The general playback status can be displayed on the TV screen. Some options can be changed on the menu.

On-screen display operation

- 1** Press **DISPLAY** during playback.
- 2** Use **▲/▼** to select an option.
The selected option will be highlighted.
- 3** Use **◀/▶** to change the setting of an option.
The number buttons can be also be used for setting numbers (e.g., title number). For some functions, press **ENTER** to execute the setting.













Temporary Feedback Field Icons

-  TITLE Repeat Title (DVD)
-  CHAPT Repeat Chapter (DVD)
-  A B Repeat A-B
-  OFF Repeat Off
-  Resume play from this point
-  Action prohibited or not available

Notes

- Some discs may not provide all of the features on the on-screen display example shown below.
- If no button is pressed for 10 seconds, the on-screen display disappears.

DVD

Options	Function (Use ▲/▼ to select desired option.)	Selection Method
Title Number  1/3	Shows the current title number and total number of titles, and skips to the desired title number.	 , or Numbers , ENTER
Chapter Number  1/12	Shows the current chapter number and total number of chapters, and skips to the desired chapter number.	 , or Numbers , ENTER
Time search  -:-:-	Shows the elapsed playing time, and searches the point by the elapsed time directly.	Numbers , ENTER
Audio language and Digital Audio Output mode  1 ENG □□□D 5.1CH	Shows the current audio soundtrack language, encoding method, and channel number, and changes the setting.	 , AUDIO
Subtitle language  OFF	Shows the current subtitles language, and changes the setting.	 , SUBTITLE
Angle  1/1	Shows the current angle number and total number of angles, and changes the angle number.	 , ANGLE
Sound  NORM.	Shows the current sound mode, and changes the setting.	

DVD Operation Setup (Continued)

Initial Settings

You can set your personal preferences on the DVD+VCR.

General Operation

- 1 Press SETUP.**
The Setup menu appears.



- 2 Use ▲▼ to select the desired option.**
The screen will show the current setting for the selected option, as well as alternate setting(s).
- 3 While the desired option is selected, press ►, then ▲▼ to select the desired setting.**
- 4 Press ENTER to confirm your selection.**
Some options require additional steps.
- 5 Press SETUP, RETURN, or ► (PLAY) to exit the setup menu.**

Language

Disc Language **DVD**

Select a language for the disc's Menu, Audio, and Subtitle features.

Original : The original language set for the disc is selected.

Other : To select another language, use number buttons to enter the corresponding 4-digit number according to the language code list on page 37. If you enter the wrong language code, press CLEAR.

Note

Disc Language selection may not work for some DVDs.



Menu Language

Select a language for the Setup menu. This is the menu you see when you press SETUP.



Picture

TV Aspect **DVD**

4:3 Letterbox: Select when a standard 4:3 TV is connected. Displays pictures with masking bars above and below the picture.

4:3 Panscan: Select when a standard 4:3 TV is connected. Displays pictures cropped to fill your TV screen. Both sides of the picture are cut off.

16:9 Wide: Select when a 16:9 wide TV is connected.

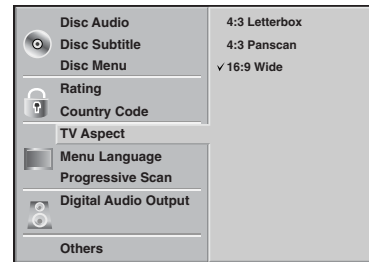

Progressive Scan **DVD**

Progressive Scan Video provides the highest resolution pictures with less flicker and line structure.

If you are using the COMPONENT/PROGRESSIVE SCAN VIDEO OUT jacks, but are connecting the DVD+VCR to a standard (analog) television, set Progressive Scan to Off.

If you are using the Component Video jacks for connection to a TV or monitor that is compatible with a progressive scan signal, set Progressive Scan to On.

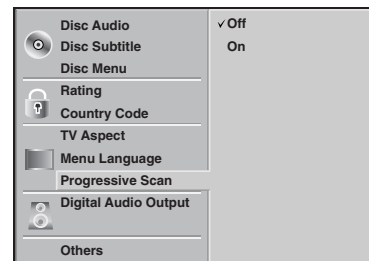

Caution

Once the setting for progressive scan output is entered, an image will only be visible on a progressive scan compatible TV or monitor. If you set Progressive Scan to On in error, you must reset the unit.

- 1) Remove any disc from the unit and close the disc tray. See that "dISC" is displayed on the display window.
- 2) Press STOP (■) and hold it for more than five seconds before releasing it. The video output will be restored to the standard setting and a picture will once again be visible on a conventional analog TV or monitor.

DVD Operation Setup (Continued)

Sound

Digital Audio Output

Each DVD disc has a variety of audio output options. Set the DVD+VCR's Digital Audio Output according to the type of audio system you use.

DOLBY DIGITAL/PCM: Select DOLBY DIGITAL/PCM if you have connected the DVD+VCR's DIGITAL AUDIO OUT jack to a Dolby Digital decoder (or an amplifier or other equipment with a Dolby Digital decoder).

Stream/PCM: Select Stream/PCM if you have connected the DVD+VCR's DIGITAL AUDIO OUT jack to an amplifier or other equipment with a DTS decoder, Dolby Digital decoder or MPEG decoder.

PCM: Select when connected to a 2 channel digital stereo amplifier. The DVD+VCR outputs sounds in the PCM 2ch format when you play a DVD video disc recorded with a Dolby Digital, MPEG1, or MPEG2 recording system.

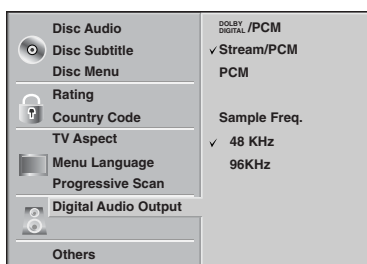

Sample Frequency

To change the Sample Frequency setting, first select the desired Digital Audio Output as indicated above. If your receiver or amplifier is NOT capable of handling 96KHz signals, select 48KHz. When this choice is made, this unit will automatically convert any 96KHz signals to 48KHz so your system can decode them. If your receiver or amplifier is capable of handling 96KHz signals, select 96KHz. When this choice is made, this unit will pass each type of signal through without any further processing.

Others

The DRC, Vocal and Auto Play settings can be changed.

- Use ▲/▼ to select the desired option and then press ENTER repeatedly to select On or Off.

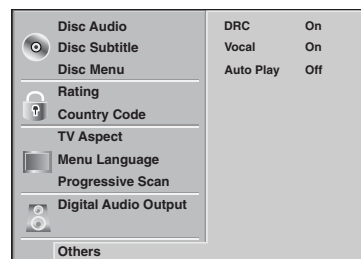

DRC (Dynamic Range Control)

With the DVD format, you can hear a program's soundtrack in the most accurate and realistic presentation possible, thanks to digital audio technology. However, you may wish to compress the dynamic range of the audio output (the difference between the loudest sounds and the quietest ones). Then, you may listen to a movie at a lower volume without losing clarity of sound. Set DRC to On for this effect.

Vocal

Set Vocal to On only when a multi-channel karaoke DVD is playing. The karaoke channels on the disc will mix into normal stereo sound.

Auto Play **DVD**

You can set up the DVD Player so a DVD disc automatically starts playing whenever the DVD is inserted. If Auto Play mode is set to On, this DVD player will search for a title that has the longest playback time and then play back the title automatically.

On: Auto Play function works.

Off: Auto Play function does not work.

Note

The Auto Play function may not work for some DVDs.

DVD Operation Setup (Continued)

Parental Control

Rating **DVD**

Movies on DVDs may contain scenes not suitable for children. Therefore, discs may contain Parental Control information that applies to the complete disc or to certain scenes on the disc. These scenes are rated from 1 to 8, and alternatively, more suitable scenes are available for selection on some discs. Ratings are country dependent. The Parental Control feature allows you to prevent discs from being played by your children or to have certain discs played with alternative scenes.

Disc Audio	8
Disc Subtitle	7
Disc Menu	6
Rating	5
Country Code	4
TV Aspect	3
Menu Language	2
Progressive Scan	1
Digital Audio Output	✓ Unlock
Others	Change

1 Select Rating on the Setup menu using ▲/▼ buttons.

2 While Rating is selected, press ►.

3 When you have not entered a password yet. Enter a 4-digit password using the numbered buttons to create a personal 4-digit security password, then press ENTER. Enter the 4-digit password again and press ENTER to verify.
When you have already entered a password; Enter a 4-digit password using the numerical buttons to confirm the personal 4-digit security password, then press ENTER.

If you make a mistake before pressing ENTER, press CLEAR and enter 4-digit security password again.

4 Select a rating from 1 to 8 using ▲/▼ buttons. **One (1) has the least playback restrictions. Eight (8) has the most playback restrictions.**
Unlock: If you select Unlock, Parental Control is not active. The disc will play in full.
Ratings 1 to 8: Some discs contain scenes not suitable for children. If you set a rating for the DVD+VCR, all disc scenes with the same rating or lower will be played. Higher rated scenes will not be played unless an alternative scene is available on the disc. The alternative must have the same rating or a lower one. If no suitable alternative is found, playback will stop. You must enter the 4-digit password or change the rating level in order to play the disc.

5 Press ENTER to confirm your rating selection, then press SETUP to exit the menu.

Country Code **DVD**

Enter the code of a country whose standards were used to rate the DVD video disc, referring to the list (See "Country Code List", page 38.).

Disc Audio	Code Set
Disc Subtitle	U S
Disc Menu	
Rating	
Country Code	
TV Aspect	
Menu Language	
Progressive Scan	
Digital Audio Output	
Others	

1 Select the Country Code option using the ▲/▼ buttons on the setup menu.

2 While Country Code is selected, press ►.

3 Follow step 3 of "Rating" on left.

4 Select the first character using the ▲/▼ buttons.

5 Press ► to shift to second character and select the second character using ▲/▼ buttons.

6 Press ENTER to confirm your Country Code selection, then press SETUP to exit the menu.

Note

Confirmation of the 4-digit password is necessary when the password is changed (see Changing the 4-digit password below).

Changing the 4-digit password

- 1 Follow Steps 1-2 as shown above to the left (Rating).
- 2 Enter the old password, then press ENTER.
- 3 Select Change using ▲/▼ buttons then press ENTER.
- 4 Enter the new 4-digit password, then press ENTER.
- 5 Enter exactly the same password a second time and verify by pressing ENTER.
- 6 Press SETUP to exit the menu.

If you forget your 4-digit password

If you forget your password, to clear the current password follow the procedure below.

- 1 Press SETUP to display the setup menu.
- 2 Enter the 6-digit number 210499 and then press ENTER.
The 4-digit password is cleared.
- 3 Enter a new password as shown above to the left (Rating).

VCR Operation

Normal Playback

Preparation:

- Turn on the TV.
- Tune the TV to the DVD+VCR output channel (CH 3 or 4) or set the TV's source selector to VIDEO.
- If a direct VIDEO/AUDIO connection is made between the DVD+VCR and the TV, set the TV's source selector to VIDEO.
- Set the Output Source to VCR as shown in "Selecting the Viewing Source" on page 6.

1 Insert a prerecorded video cassette.

The  indicator will light and the DVD+VCR will power-up automatically.

- Make sure that the  indicator in the display window is not lighted. If it is, press **POWER** once.
- If a tape without a safety tab is inserted, the unit will start playback automatically.

2 Press **▶ (PLAY)** once.

PLAY appears on the TV screen .

- It is not necessary to select the tape speed for playback. It will be automatically selected by the DVD+VCR.
- In playback, the **TV/VCR** selector switches to VCR mode automatically.

3 Press **■ (STOP)** to stop playback.

STOP appears on the TV screen.

- If the tape reaches the end before **■ (STOP)** is pressed, the DVD+VCR will automatically stop, rewind and eject the tape, and it will turn itself off.

Tracking Control

Auto Tracking

The automatic tracking function adjusts the picture to remove snow or streaks.

The AUTO TRACKING function works in the following cases:

- A tape is played back for the first time.
- Tape speed (SP, LP, SLP) changes.
- Streaks or snow appear because of scratches on the tape.

Manual Tracking

If noise appears on the screen during playback, press either **CH/TRK ▲/▼** on the remote control or **CH (▲/▼)** on the front panel until the noise on the screen is reduced.

- In case of vertical jitter, adjust tracking controls very carefully.
- Tracking is automatically reset to normal when the tape is ejected or the power cord is unplugged for more than 3 seconds.

Special Effect Playbacks

Special effects playback notes

- Horizontal lines (noise bars) will appear on the TV screen. This is normal.
- The audio is automatically muted during special effect modes, so there is no sound during search.
- During high-speed picture search mode, a short period is needed to stabilize tape speed when re-entering the PLAY mode. Slight interference may be observed during this period.

Search

This function lets you quickly and visually search for a desired tape section in either direction: forward or reverse.

1 Press **◀◀ (BACKWARD)** or **▶▶ (FORWARD)** during playback.

The DVD+VCR will be activated in the SEARCH mode.

- If the DVD+VCR is left in the SEARCH mode for more than 3 minutes, the DVD+VCR will automatically enter the PLAY mode, to protect the tape and video heads.

2 To return to playback, press **▶ (PLAY)**.

Still Picture and Frame-by-Frame Playback

1 Press **■ (PAUSE/STEP)** during playback.

Still picture will appear on the TV screen.

- If a still picture vibrates vertically, stabilize it using **▲/▼** on the remote control.
- If the DVD+VCR is left in the STILL mode for more than 5 minutes, the DVD+VCR will automatically enter the STOP mode to protect the tape and video heads.

2 Press **■ (PAUSE/STEP)** repeatedly to advance the video picture one frame at a time while viewing a still picture.

3 To return to playback, press **▶ (PLAY)**.

Slow Motion

1 While in still mode, press **▶▶ (FORWARD)**.

The tape will be played back at a speed 1/19 times slower than the normal speed.

- During slow playback, use **▲/▼** on the Remote Control to minimize noise bands.
- If slow motion mode continues for more than 3 minutes, the DVD+VCR will automatically change to playback mode.

2 To return to playback, press **▶ (PLAY)**.

CM SKIP (Commercial Skip)

This is useful for skipping commercials or short program segments.

1 Press **CM SKIP** during playback.

The tape will fast forward picture search through 30 seconds of recording.

- Skipping time can be extended by pressing **CM SKIP** repeatedly.
- Subsequent presses result in advancing the fast forward picture search time by 30-second increments (maximum 3 minutes).

2 When the search is complete, the DVD+VCR will go into playback mode automatically.

VCR Operation (Continued)

Normal Recording

Preparation:

- Turn on the power of both the DVD+VCR and TV.
- Tune the TV to the DVD+VCR output channel (CH 3 or 4) or set the TV's source selector to VIDEO.
- If a direct VIDEO/AUDIO connection is made between the DVD+VCR and the TV, set the TV's source selector to VIDEO.

1 Insert a video cassette with the safety tab intact.

2 Select the desired channel with CH/TRK (▲▼).

- If you are recording from another source via audio/video input jacks (at the Rear or Front panel), select the LINE1 or LINE2 with INPUT.

3 Set the desired recording speed (SP or SLP) with SPEED.

- This DVD+VCR is not designed to record in LP mode.

4 Set the MTS mode as desired (See page 15, 25).

5 Press REC/ITR (●) once.

Recording will start. (The REC indicator will light in the display window.)

- REC indicator appears only when the Output Source is set to VCR.
- If a cassette with no safety tab is loaded, the cassette will be ejected automatically.

6 Press STOP (■) to stop recording.

If the tape reaches the end before STOP (■) is pressed, the DVD+VCR will automatically stop, rewind, eject the tape and turn itself off.

To pause recording

1 Press PAUSE/STEP (||) to pause the tape during recording.

The REC indicator will flash in the display window.

2 When you want to continue recording, press PAUSE/STEP (||) or press REC/ITR (●).

- After 5 minutes in pause mode, the tape will be stopped automatically to protect the tape and the video heads.

To record one TV program while watching another

1 Use TV/VCR to select the TV mode during recording. The TV indicator appears.

2 Using the TV, select the channel to be viewed.

Tips

Always use PAUSE/STEP (||) for best results when making changes during recording.

For example: To change channels during recording, first press PAUSE/STEP (||) to put the unit in Pause mode. Then select the desired channel on the DVD+VCR, and press PAUSE/STEP (||) again to resume recording.

Timer Recording

This DVD+VCR can be programmed to record up to 8 programs within a period of 1 year. For unattended recording, the timer needs to know the channels to be recorded and the starting and ending times.

Things to know before starting

- If you try to set the program timer before setting the clock, PLEASE SET THE CLOCK appears for a moment and then CLOCK menu appears on the TV screen. Set the time and date before proceeding.
- Make sure a tape is in the DVD+VCR and the safety tab is in place or the tape will be automatically ejected.

Preparation:

- Turn on the power of both the DVD+VCR and the TV.
- Be sure the TV is set to the DVD+VCR output channel (3 or 4).
- Make sure the TUNING BAND in the TUNING menu is set appropriately (TV or CATV).

1 Press MENU and the MAIN menu will appear.

2 Use ▲▼ to choose the PROGRAM menu.

3 Press ENTER to go to the PROGRAM menu. The PROGRAM menu will appear.

- If all 8 programs have been entered, FULLY PROGRAMMED message will appear for a moment and then PROGRAM 1 will appear on the TV screen.

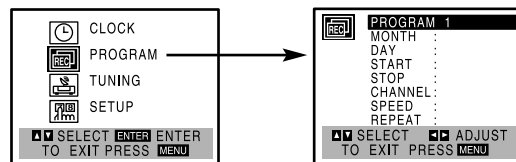

4 Use ◀▶ to choose the PROGRAM No. (1-8).

5 Use ▼ to choose the MONTH option.

Use ◀▶ to choose the desired month.

6 Use ▼ to choose the DAY option.

Use ◀▶ to choose the desired day.

7 Use ▼ to choose the START option.

Use ◀▶ to choose the desired start time.

8 Use ▼ to choose the STOP option.

Use ◀▶ to choose the desired stop time.

9 Use ▼ to choose the CHANNEL option.

Use ◀▶ to choose the desired channel (Channel, LINE1 or LINE2).

Cable Users: If you have CABLE TV and used Cable Box in Connecting Antenna/Cable TV to DVD+VCR (page 11), using a cable box converter, you must set the channel in this step to match the cable box output channel (usually CH 3 or 4). Change channels on the cable box instead of with the DVD+VCR.

VCR Operation (Continued)

- 10** Use **▼** to choose the **SPEED** option.
Use **◀▶** to choose the desired recording speed (**AUTO**, **SP** or **SLP**).
- **AUTO** mode determines how much tape is left and switches speed from **SP** to **SLP**, if necessary, to complete recording the program. There will be some picture and sound distortion at the point of the speed change.

- 11** Use **▼** to choose the **REPEAT** option.
Use **◀▶** to choose the desired repeat (**ONCE**, **WEEKLY** or **DAILY**).
- ONCE event**....for recording up to 8 programs on a single day or over the days within a period of 1 year.
WEEKLY event....for recording up to 8 programs on a certain day of every week.
DAILY event....for recording up to 8 programs at the same time(s) Monday through Friday.

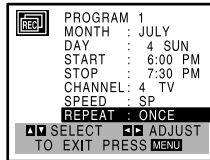

Tip

If the input data is wrong, use **▲** to select the data and correct it using **◀▶**.

12 Press MENU, the program will be memorized by the DVD+VCR.

- **Ⓞ** indicator lights in the display window.
- If the program preset time has past, the **PAST TIME PROGRAMMED** message will appear on the TV screen. Return to the incorrect program and program it with the correct time.
- If you had entered a past date, timer recording will be performed on that date of the next year.
- Additional programs may be entered by repeating steps 1-12.

Cable Users: If your cable hookup is via a Cable converter box, you can program multiple recordings only on the converter box output channel. This is because the converter determines what channel you view through your DVD+VCR.

Tip

If you are finished programming and you want to set the DVD+VCR to record the programs you have entered, **MAKE SURE YOU HAVE INSERTED A TAPE INTO THE DVD+VCR.** The DVD+VCR is now set to record the preset programs.

Notes

If the power fails or the DVD+VCR is unplugged from the AC outlet, the correct clock time and timer settings are kept in memory for approximately 3 seconds. After 3 seconds, the clock and program timer must be reset when power is restored. Reset the clock according to instructions.

After setting up a timer recording, recording will start if no other timer recordings are scheduled to occur at the same time (see "Program Priority" at right).

Checking (Erasing) Timer Record Programming

Programming can be checked whenever the DVD+VCR is turned on.

- 1 Press **MENU** and the **MAIN** menu will appear.
- 2 Use **▲/▼** to choose the **PROGRAM** menu.
Press **ENTER** and the **PROGRAM** menu will appear.

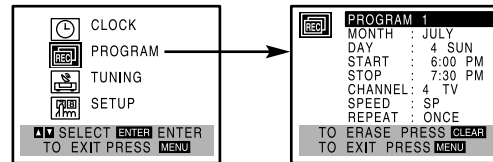

- 3 Use **◀▶** to select a program you want to check or erase. If you want to erase the program, press **CLEAR**.
- 4 Press **MENU** to return to the TV screen.

Program Priority

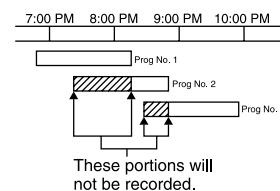

If the starting and ending times of two or more timer recordings overlap on the same day, priority is given to the earliest recording. For example, in the diagram at left Program number 2 will

not be recorded until Program number 1 is finished. The first part of Program number 2 will not be recorded. Likewise, Program number 3 will not be recorded until Program number 2 is finished, and so on.

VCR Operation (Continued)

Instant Timer Recording

Instant Timer Recording allows you to make a recording easily of a preset length without using the program timer.

Preparation:

- Turn on the power of both the DVD+VCR and the TV.
- Be sure the TV is tuned to the DVD+VCR output channel (3 or 4).
- If a direct VIDEO/AUDIO connection is made between the DVD+VCR and the TV, set the TV's source selector to VIDEO.

- 1 Insert a video cassette with the safety tab intact.**
- 2 Select the desired channel with ▲/▼ or number (0-9).**

The channel number appears on the TV screen.

 - If you are recording from another source via audio/video input jacks (at the Rear or Front panel), select LINE1 or LINE2.
- 3 Select the desired recording speed (SP or SLP) with SPEED.**

The tape speed will appear on the TV screen.
- 4 Press REC/ITR (●) twice.**

The menu as illustrated, will appear on the TV screen.

 - Recording will start (The Ⓞ indicator will light).
- 5 Press REC/ITR (●) repeatedly to select the recording time length.**

At the end of the recording, the DVD+VCR will stop recording and shut off.

 - During Instant Timer Recording, changing the channel on the DVD+VCR will not be possible.
 - You can stop the recording by pressing STOP (■).

INSTANT TIMER RECORD MENU

INSTANT TIMER RECORD	
CHANNEL	2
SPEED	SP
START LENGTH	NOW 0H30M

0H30M 9H00M → 0H00M
↑
Length Display
(each additional press of
REC/ITR (●) increases recording
time 30 minutes)

Checking the Recording Time

Press REC/ITR (●) once to check the recording time. The recalled setting will automatically return to the TV screen after 6 seconds.

To extend the Recording Time

The recording time can be extended anytime by pressing REC/ITR (●). Subsequent presses result in advancing the recording time by 30-minute increments.

Notes

- If you press PAUSE/STEP (||) during instant timer recording, the DVD+VCR will enter the recording pause mode. Instant timer recording is cancelled.
- If the DVD+VCR is set to "0H00M", the DVD+VCR goes to normal recording mode.

Dubbing and Editing

If you wish to edit or dub your camcorder (or another VCR) recordings to this DVD+VCR, the rear (or Front) panel mounted Audio and Video (A/V) input jacks make the connections quick and easy. These direct A/V jacks will also provide better picture results than using the RF jack on the rear panel.

- 1 Connect the camcorder's (or another VCR's) A/V outputs to your DVD+VCR as illustrated on page 13.**
- 2 Set the input channel "LINE2". (use INPUT to select LINE2.)**
 - If you have connected your DVD+VCR to the A/V input jacks on the rear of DVD+VCR, you should select the input channel LINE1 by pressing INPUT twice.
- 3 Play the tape in the camcorder (or another VCR). If you have a TV attached to your DVD+VCR, you can see the video playing.**
- 4 When you desire the recording to begin, press DVD+VCR's REC/ITR (●) once to start.**

Note

Before recording, please confirm the recording start position.

Copying from DVD to VCR

This unit allows you to copy the contents of a DVD to a VHS tape.

Note

If the DVD you are attempting to copy is copy protected, you will not be able to copy the disc. It is not permitted to copy Macrovision encoded DVDs. "Lock" is displayed in the display window.

- 1 Insert Disc**

Insert the disc you wish to copy in the DVD deck and close the disc tray.
- 2 Insert VHS Tape**

Insert a blank VHS video tape into the VCR deck.
- 3 Press the COPY button on the unit front panel.**

The DVD will go into Play mode and the VCR will go into Record mode.

 - If the DVD disc menu appears, you may need to press ► (PLAY) manually to begin copying.
 - "REC" indicator will light.
- 4 Stopping the Copy Process**

When the DVD is finished playing, press the VCR button on the remote control and then press STOP (■) to end copying.

You must stop the Copy process manually when the DVD movie ends, or the unit may replay and record over and over again.

Note

When you stop the DVD playback during copying, the VCR recording mode stops automatically.

VCR Operation (Continued)

VHS Hi-Fi Stereo System/ MTS Broadcast

This DVD+VCR is equipped with the VHS Hi-Fi audio sound system for recording and playback. The information below gives a brief description of Hi-Fi audio and how to record and play a tape in the Hi-Fi audio mode.

Playback with Hi-Fi Stereo Audio Sound

A stereo TV with AUDIO/VIDEO input jacks or a stereo audio system is required for true stereo playback. To experience the full and rich stereo sound available with Hi-Fi recorded tapes, we recommend the connection of this unit to a home stereo audio system.

- 1 Set the **AUDIO MODE** option to **HI-FI** on the **SETUP** menu .

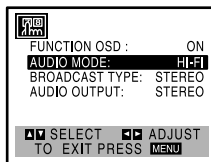

- 2 Set the **AUDIO OUTPUT** option to **STEREO** position.

(STEREO) POSITION: The left channel sound (L) is heard from the left speaker and the right channel sound (R) is heard from the right speaker.

(LEFT) POSITION: The left channel sound (L) is heard from both speakers.

(RIGHT) POSITION: The right channel sound (R) is heard from both speakers.

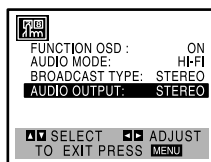

- 3 Press **MENU**.

- 4 Insert a cassette and press **▶ (PLAY)**.
Adjust volume at your stereo system.

MTS (Multi-Channel TV Sound)

This DVD+VCR will decode MTS stereo and bilingual (SAP) off-the-air broadcast sound signals. It also decodes stereo TV sound from local cable companies, as long as they operate on assigned cable frequencies and use the EIA-recommended MTS stereo/bilingual TV sound system.

Multichannel TV Sound Indicator (MTS)

Shows onscreen as illustrated below when **ENTER** is pressed.

- One or both of the indicators will light, depending on the MTS broadcast.

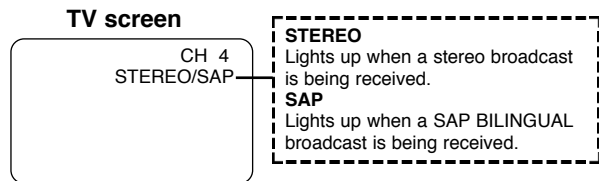

If only **STEREO** appears on the TV screen.

The DVD+VCR can record in stereo onto the VHS Hi-Fi audio tracks when the **BROADCAST TYPE** option is in the **STEREO** position. The DVD+VCR will also record mono audio onto the mono audio track.

If only **SAP** appears on the TV screen.

Set the **BROADCAST TYPE** option to **SAP**.

If **STEREO/SAP** appears on the TV screen

Use the **BROADCAST TYPE** option to select the desired recording mode (**STEREO** or **SAP**).

SAP (Second Audio Program) Recording

Some stations transmit a Second Audio Program, which is used for a second language or additional information. When the station broadcasts a Second Audio Program, follow the procedure below to record the SAP.

- 1 Insert a video cassette with the safety tab intact.
- 2 Set the **BROADCAST TYPE** option to **SAP** (**SETUP** menu).

Do this if only the SAP appears on the TV screen or you know the program will use the SAP.

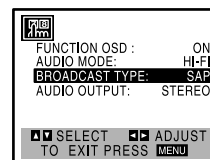

- 3 Press **MENU**.

- 4 Select the desired recording speed (**SP** or **SLP**) with **SPEED**.

- 5 Select the desired channel. **SAP** should appear on the TV screen.

- 6 Press **REC/TR (●)** once

You are now recording the program you see and hear on the TV.

- 7 Press **STOP (■)** to stop recording.

VCR Operation (Continued)

Tape Counter Memory Feature

Real-Time Counter

Shows length of tape run in hours, minutes, and seconds. Press **CLK/CNT** to select the real-time counter display.

Every press of **CLK/CNT** changes the TV screen as illustrated below.



- Counter changes to "0:00:00" when the cassette is ejected.
- The real-time counter does not operate if nothing is recorded on the tape.
- The real-time counter will not work unless a tape is inserted.

Counter Memory Function

This is useful if there is a section of tape you want to view immediately after recording or if you want to return to the same point several times.

- 1** Begin recording or playing a tape.
- 2** Press **CLK/CNT** repeatedly to display the real-time counter on the TV screen.
- 3** At the point that you want locate later, reset the real-time counter to "0:00:00" by pressing **CLEAR**.
- 4** Continue to play or record.
- 5** Press **STOP** (■) when recording or playback finishes.
- 6** Press **BACKWARD** (◀◀).
The tape automatically stops when the tape counter returns to about "0:00:00".

Tape Remaining

This function shows the remaining time on the tape during recording or playback.

Press **CLK/CNT** repeatedly until the **REM** indicator appears on the TV screen during recording or playback.

Note

The remaining tape length indicator may not be displayed correctly depending on the condition of the tape and the kind of the tape (T-140, T-160, or T-210 etc.).

Additional Information

- In manual recording, Timer recording, Instant Timer Recording, playback, or fast forward modes, the DVD+VCR automatically starts rewinding the tape at the end of the tape. The cassette will stop at the beginning of the tape and be ejected, and the DVD+VCR will turn itself off.
- After you have finished using the DVD+VCR, rewind, eject, and remove the cassette. Place the cassette in its protective sleeve to protect it from dust. It is not necessary to rewind the cassette before removing it, but if you do, it will be ready to play or record the next time you use it.
- Be sure the DVD+VCR Channel Selector is on the correct channel you wish to record. The channel that is being recorded can always be checked by tuning the television to the DVD+VCR channel (3 or 4) and pressing the **TV/VCR** selector to turn the DVD+VCR's TV indicator off.
- Do not attempt to hook up more than one television set to the DVD+VCR for either recording or playback.

Auto Play System

This DVD+VCR features automatic playback.

Load a cassette (with the safety tab removed).

- The Output Source is changed to VCR mode automatically.
- The power turns on automatically and playback begins.
- At the end of the tape, the DVD+VCR stops, then rewinds.
- The cassette is ejected after rewinding and the VCR turns itself off automatically.

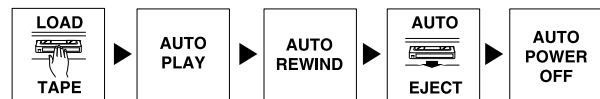

Note

Auto power off does not function during regular DVD play mode. (DVD+VCR power stays on.)

S-VHS Quasi Playback (SQPB)

- This DVD+VCR can play back S-VHS recorded tapes, however, it cannot make recordings using S-VHS format tapes.
- SQPB is an abbreviation for S-VHS Quasi Playback.

DVD Operation

Playing DVDs



Playback Setup **DVD**

- Turn on the TV and select the video input source connected to the DVD+VCR.
- Audio system: Turn on the audio system and select the input source connected to the DVD+VCR.
- Set the Output Source to DVD as shown in "Selecting the Viewing Source" on page 6.

1 Press OPEN/CLOSE () to open the disc tray.

2 Load your chosen disc in the tray, with the label facing up.





When a double-sided DVD is inserted, make sure the side you want to play is facing down.

3 Press OPEN/CLOSE () to close the tray. Playback starts automatically. If playback does not start, press  (PLAY). In some cases, the disc menu might appear instead.

If a menu screen is displayed

The menu screen may be displayed first after loading a DVD which contains a menu.

DVD

Use , , ,  buttons to select the title/chapter you want to view, then press ENTER to start playback. Press TITLE or DISC MENU to return to the menu screen.

Notes

- If Parental Control is set and the disc is not within the Rating settings (not authorized), the 4-digit password must be entered and/or the disc must be authorized (see Parental Control, on page 20).
- DVDs may have a Region Code.
- Your DVD+VCR will not play discs that have a Region Code different from your DVD+VCR. The Region Code for this DVD+VCR is 1 (one).
- Do not keep a fixed image displayed on the screen for a long time.

Screen Saver

The screen saver picture appears if you leave the DVD+VCR in Stop mode for about five minutes.

Last Scene Memory

This player memorizes last scene from the last disc that is viewed. The last scene remains in memory even if you remove the disc from the player or switch off the player. If you load a disc that has the scene memorized, the scene is automatically recalled.

Note

This player does not memorize the scene of a disc if you switch off the player before commencing to play the disc.

General Features

Note

Unless stated otherwise, all operations described use the remote control. Some features may also be available on the Setup menu.

Selecting other TITLES **DVD** 1/3





When a disc has more than one title, you can select another title as follows:

- Press DISPLAY, then press the appropriate number buttons (0-9) to select a title number.

Selecting other CHAPTERS

DVD 1/12















When a title on a disc has more than one chapter or a disc has more than one track, you can select another chapter as follows:

- Press SKIP  or  briefly during playback to return to the beginning of the current chapter or to select the next chapter.
- Press SKIP  twice briefly to step back to the previous chapter.
- To go directly to any chapter during playback, press DISPLAY. Use ,  to select Chapter icon. Then, enter the chapter number with the number buttons (0-9).

Note

For two-digit numbers, press the numbered buttons (0-9) in rapid succession.

Slow Motion **DVD**

- 1 Press PAUSE/STEP () during playback. The DVD+VCR will now go into PAUSE mode.
- 2 Press BACKWARD () or FORWARD () during pause mode. The DVD+VCR will enter SLOW mode.
- 3 Use BACKWARD () or FORWARD () to select the required speed:  1/16,  1/8,  1/4,  1/2 (backward), or  1/16,  1/8,  1/4,  1/2 (forward).
- 4 To return to playback, press  (PLAY).

DVD Operation (Continued)

General Features (Continued)

Still Picture and Frame-by-Frame Playback

- 1 Press PAUSE/STEP (II) during playback. The DVD+VCR will go into PAUSE mode.
- 2 With a DVD, you can advance the picture frame by frame by pressing PAUSE/STEP (II) repeatedly on the remote control.
- 3 To return to playback, press ► (PLAY).

Search

- 1 Press BACKWARD ◀◀ or FORWARD ▶▶ during playback. The DVD+VCR will now go into SEARCH mode.
- 2 Press BACKWARD ◀◀ or FORWARD ▶▶ repeatedly to select the required speed:
◀◀X2, ◀◀X4, ◀◀X16, ◀◀X100 (backward) or ▶▶X2, ▶▶X4, ▶▶X16, ▶▶X100 (forward).
- 3 To return to playback, press ► (PLAY).

Random

- 1 Press RANDOM during playback or in Stop mode. The unit automatically begins Random Playback and "RANDOM" appears on the TV screen.
- 2 To return to normal playback, press RANDOM until "NORMAL" appears on the TV screen.

Tip

By pressing SKIP ◀◀ or ▶▶ during Random playback, the unit selects another title (track) and resumes Random playback.

Note

This function only works with DVD Karaoke discs.

Repeat

DVD Video Discs - Repeat Chapter/Title/Off

- 1 To repeat the currently playing chapter, press REPEAT. The Repeat CHAPT icon appears on the TV screen.
- 2 To repeat the title currently playing, press REPEAT a second time. The Repeat TITLE icon appears on the TV screen.
- 3 To exit Repeat mode, press REPEAT a third time. The Repeat OFF icon appears on the TV screen.

Repeat A-B

To repeat a sequence in a title:

- 1 Press A-B at your chosen start point. **A *** appears briefly on the TV screen.
- 2 Press A-B again at your chosen end point. **A B** appears briefly on the TV screen, and the repeat sequence begins.
- 3 To cancel the sequence, press A-B.

Time Search

The Time Search function allows you to start playing at any chosen time on the disc.

- 1 Press DISPLAY during playback. The on-screen display appears on the screen. The Time Search box shows the elapsed playing time of the current disc.
- 2 Within 10 seconds, use ▲▼ to select the Time Search icon in the on-screen display. The ":-:--:" appears in the Time Search box.
- 3 Within 10 seconds, use the numbered buttons to enter the required start time. Enter hours, minutes and seconds from left to right in the box. If you enter the wrong numbers, press CLEAR to remove the numbers you entered. Then enter the correct numbers.
- 4 Within 10 seconds, press ENTER. Playback starts from the selected time on the disc. If you enter an invalid time, playback will continue from the current point.

3D Surround

This unit can produce a 3D Surround effect, which simulates multi-channel audio playback from two conventional stereo speakers, instead of the five or more speakers normally required to listen to multi-channel audio from a home theater system.

- 1 Press DISPLAY during playback.
- 2 Use ▲▼ to select the sound icon. The sound option will be highlighted.
- 3 Use ◀▶ to select "3D SUR". To turn off the 3D Surround effect, select "NORM."

Zoom

The Zoom function allows you to enlarge the video image and to move through the enlarged image.

- 1 Press ZOOM during playback or still playback to activate the Zoom function. If you press ZOOM repeatedly, the magnification level increases up to six steps.
- 2 Use ◀▶/▲▼ buttons to move through the zoomed picture.
- 3 Press CLEAR to resume normal playback or return to the paused image.

Notes

- The Zoom function may not work for some DVDs.
- The Zoom function may not work on multi-angle scenes.

DVD Operation (Continued)

General Features (Continued)

Marker Search 1/9

You can start playback from a memorized point. Up to nine points can be memorized.

To enter a mark, follow these steps.

- 1 During disc playback, press **MARKER** when playback reaches the spot that you want to memorize.
The Marker icon will appear on the TV screen briefly.
- 2 Repeat step 1 to enter up to nine Marker points on a disc.

To Recall a Marked Scene

- 1 During disc playback, press **SEARCH**.
The Marker Search menu will appear on the screen.
- 2 Within 10 seconds, use **◀/▶** or number button to select a Marker number that you want to recall.
- 3 Press **ENTER**.
Playback will start from the Marked scene.
- 4 To remove the **MARKER SEARCH** menu, press **SEARCH**.

To Clear a Marked Scene

- 1 During disc playback, press **SEARCH**.
The Marker Search menu will appear on the screen.
 - 2 Within 10 seconds, use **◀/▶** or number button to select a Marker number that you want to erase.
 - 3 Press **CLEAR**.
The Marker number will be erased from the list.
 - 4 Repeat steps 2 and 3 to erase additional Marker numbers.
 - 5 To remove the **MARKER SEARCH** menu, press **SEARCH**.
- All markers are erased when the disc is ejected.

Changing Video Mode

- With certain discs, the playback picture may be flickering or Dot Crawl is shown on straight lines. That means Vertical interpolation or De-interlace is not perfectly matched with the disc. In this case, the picture quality may be improved by changing the video mode.
- To change the video mode, press and hold **DISPLAY** about 3 seconds during disc playback. The new video mode number selected is displayed on the TV screen. Check whether the video quality has improved. If not, repeat the above procedure until picture quality is improved.
- Video mode sequence:
MODE1 → MODE2 → MODE3 → MODE1
- If you turn off the power, the video mode will return to initial default state (MODE1).

Detailed Description of each Video Mode

MODE1 : The source material of the DVD video (film material or video material) is determined from disc information.

MODE2 : Suitable for playing film based content or video based material recorded by the progressive scan method.

MODE3 : Suitable for playing video based content with comparatively little motion.

Note

The video mode setting only works when the Progressive Scan option is set to "On" in the Setup menu.

Special DVD Features

Checking the contents of DVD Video discs: Menus

DVDs may contain menus that allow you to access special features. To use the disc menu, press **DISC MENU**. Then, press the appropriate number button to select an option. Or, use **◀/▶/▲/▼** buttons to highlight your selection, then press **ENTER**.

Title Menu

- 1 Press **TITLE**.
If the current title has a menu, the menu will appear on the screen. Otherwise, the disc menu may appear.
- 2 The menu can list camera angles, spoken language and subtitle options, and chapters for the title.
- 3 To remove the title menu, press **TITLE** again.

Disc Menu

- 1 Press **DISC MENU**.
The disc menu is displayed.
- 2 To remove the disc menu, press **DISC MENU** again.

Camera Angle 1/1

If the disc contains sequences recorded from different camera angles, the angle icon blinks on the TV screen. You can then change the camera angle if you wish.

- Press **ANGLE** repeatedly during playback to select a desired angle.
The number of the current angle appears on the display.

Changing the Audio Language



Press **AUDIO** repeatedly during playback to hear a different audio language or audio track.

Subtitles 1 ENG

Press **SUBTITLE** repeatedly during playback to see the different subtitle languages.

Note

If  appears, the feature at that moment or with that specific DVD.

Audio CD and MP3/WMA Disc Operation

Playing Audio CDs and MP3/WMA Discs

CD **MP3** **WMA**

The DVD+VCR can play MP3/WMA formatted recordings on CD-ROM, CD-R or CD-RW discs. Before playing MP3/WMA recordings, read the notes on MP3/WMA Recordings on right.

1 Insert a disc and close the tray.

Audio CD; Audio CD menu appears on the TV screen go to step 4.

MP3/WMA disc; The MP3/WMA-JPEG choice menu appears on the TV screen. Go to step 2



2 Use ▲/▼ to select the MP3/WMA then press ENTER.

The MP3/WMA menu appears on the TV screen. Press RETURN to move to the MP3/WMA-JPEG choice menu.

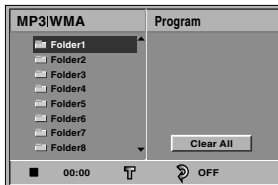

3 Use ▲/▼ to select a folder, and ENTER.

A list of files in the folder appears.

4 Use ▲/▼ to select a track then press ► (PLAY) or ENTER.

Playback starts.

During playback, the current track's elapsed playing time will appear on the display window and menu.

Playback will stop at the end of the disc.

Press TITLE to move to the next page.

Press DISC MENU to move to the previous page.

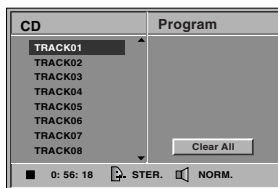

Audio CD Menu

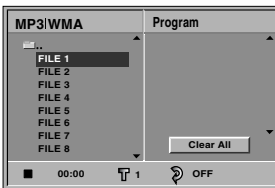

MP3/WMA Menu



If you are in a file list and want to return to the Folder list, use the ▲/▼ to highlight  and press ENTER to return to the previous menu screen.

5 To stop playback at any other time, press STOP (■).

MP3/WMA Recording Notes

About MP3

- An MP3 file is audio data compressed by using the MPEG1 audio layer-3 file-coding scheme. We call files that have the ".mp3" file extension "MP3 files".
- The player can not read an MP3 file that has a file extension other than ".mp3".

About WMA (Window Media Audio) Files

- A WMA file is made using Microsoft audio compression technology.
- WMA (Windows Media Audio) offers double the audio compression of the MP3 format.

MP3/WMA Disc compatibility with this player is limited as follows:

1. Sampling Frequency / only at 44.1kHz (MP3), 22.05 - 44.1kHz (WMA)
2. Bit rate / within 32 - 320kbps (MP3), 32 - 128kbps (WMA)
3. CD-R physical format should be "ISO 9660"
4. If you record MP3/WMA files using the software which cannot create a FILE SYSTEM, for example "Direct-CD" etc., it is impossible to playback MP3/WMA files. We recommend that you use "Easy-CD Creator", which creates an ISO9660 file system.
5. A single session disc requires MP3/WMA files in the first track. If there is no MP3/WMA file in the 1st track, it cannot playback MP3/WMA files. If you wish to playback MP3/WMA files, format all the data in the disc or use a new one.
6. File names should be named using 8 letters or less and must incorporate ".mp3" or ".wma" extension e.g. "*****.MP3" or "*****.WMA".
7. Do not use special letters such as "/ : * ? < >" etc.
8. Total number of files on the disc should be less than 650.

This DVD+VCR requires discs/recordings to meet certain technical standards in order to achieve optimal playback quality. Pre-recorded DVDs are automatically set to these standards. There are many different types of recordable disc formats (including CD-R containing MP3 or WMA files). That require certain pre-existing conditions (see above) to insure compatible playback.

Customers should also note that permission is required in order to download MP3/WMA files and music from the Internet. Our company has no right to grant such permission. Permission should always be sought from the copyright owner.

Audio CD and MP3/WMA Disc Operation (Continued)

Pause **CD** **MP3** **WMA**

- 1 Press PAUSE/STEP (II) during playback.
- 2 To return to playback, press ► (PLAY) or press PAUSE/STEP (II) again.

Selecting other Tracks **CD** **MP3** **WMA**

- Press SKIP ◀◀ or ▶▶ briefly during playback to go to the next track or to return to the beginning of the current track.
- Press SKIP ◀◀ twice briefly to step back to the previous track.
- For audio CDs, to go directly to any track, enter the track number using the numbered buttons (0-9) during playback.

Repeat Track/All/Off **CD** **MP3** **WMA**

- 1 To repeat the track currently playing, press REPEAT. The Repeat icon and "TRACK" appear on the menu screen.
- 2 To repeat all tracks on a disc, press REPEAT a second time. The Repeat icon and "ALL" appear on the menu screen.
- 3 To cancel Repeat mode, press REPEAT a third time. The Repeat icon and "OFF" appear on the menu screen.

Search **CD** **MP3** **WMA**

- 1 Press and hold BACKWARD ◀◀ or FORWARD ▶▶ for about two seconds during playback. The player will now go into SEARCH mode.
- 2 Press and hold BACKWARD ◀◀ or FORWARD ▶▶ repeatedly to select the required speed: ◀◀X2, ◀◀X4, ◀◀X8 (backward) or ▶▶X2, ▶▶X4, ▶▶X8 (forward). Search speed and direction are indicated on the menu screen.
- 3 To exit SEARCH mode, press ► (PLAY).

Random **CD** **MP3** **WMA**

- 1 Press RANDOM during playback or when playback has stopped. The unit automatically begins Random Playback and "RAND." appears on the menu screen.
- 2 To return to normal playback, press RANDOM repeatedly until "RAND." disappears from the menu screen.

Repeat A-B **CD**

To repeat a sequence.

- 1 During disc playback, press A-B at your chosen starting point. The Repeat icon and "A * " appears on the menu screen.
- 2 Press A-B again at your chosen end point. The Repeat icon and "A B" appears on the menu screen, and the sequence begins to play repeatedly.
- 3 To exit the sequence and return to normal play, press A-B again. The Repeat icon and "OFF" appears on the menu screen.

3D Surround **CD**

This unit can produce a 3D Surround effect, which simulates multi-channel audio playback from two conventional stereo speakers, instead of the five or more speakers normally required to listen to multi-channel audio from a home theater system.

- 1 Press **DISPLAY** or **AUDIO** during playback.
- 2 Use ◀/▶ to select the sound icon. The sound option will be highlighted.
- 3 Use ▲/▼ to select "NORM.", or "3D SUR".

Changing the Audio Channel **CD**

Press **AUDIO** repeatedly during playback to hear a different audio channel (STER., LEFT, or RIGHT).

JPEG File Operation

Viewing JPEG Files on a Disc **JPEG**

This DVD+VCR can play discs with JPEG files and Kodak Picture CDs. Before playing JPEG recordings, read the Notes on JPEG Files on right.

- 1 Insert a disc and close the tray.**
The MP3/WMA-JPEG selection menu appears on the TV screen.



- 2 Use ▲/▼ to select the JPEG then press ENTER.**
The JPEG menu appears on the TV screen.



- 3 Use ▲/▼ to select a folder, and ENTER.**
A list of files in the folder appears.
Press RETURN to move to the MP3/WMA-JPEG selection menu.

T Tip

If you are in a file list and want to return to the Folder list, use the ▲/▼ buttons on the remote to highlight “...” and press ENTER to return to the previous menu screen.

- 4 If you want to view a particular file, use ▲/▼ to highlight the file and press ENTER or ► (PLAY).**

Viewing the file proceeding starts.
During viewing a file, press RETURN to move to the previous menu (JPEG menu).
Press TITLE to move to the next page.
Press DISC MENU to move to the previous page.

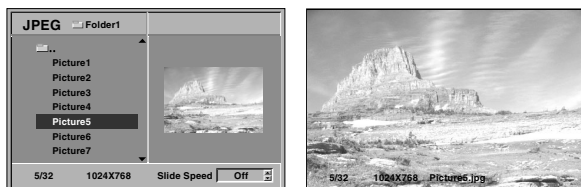

T Tip

There are three viewing Slide Speed options: Fast, Normal, Slow, and Off. Use ◀/▶ to highlight the Slide Speed option then use ▲/▼ to select the speed you want to use, and then press ENTER.

- 5 To stop viewing at any other time, press STOP (■).**
The JPEG menu appears.

Selecting other Files

Press SKIP ◀◀ or ▶▶ once while viewing a picture to advance to the next file or to the previous file.

Still Picture

- 1 Press PAUSE/STEP (||) while showing a slide show.
The player will now go into PAUSE mode.
- 2 To return to the slide show, press ▶ (PLAY) or press PAUSE/STEP (||) again.

To flip the picture

Press ▲/▼ while showing a picture to flip the picture horizontally or a vertically.

To rotate picture

Press ◀/▶ while showing a picture to rotate the picture clockwise or counter clockwise.

Notes on JPEG Files

- Depending upon the size and number of the JPEG files, it could take a long time for the DVD player to read the disc's contents. If you don't see an on-screen display after several minutes, some of the files are too big — reduce the resolution of the JPEG files to less than 2 mega pixels and burn another disc.
- Total number of files and folders on the disc should be less than 650.
- Some disc may be incompatible due to different recording format or condition of disc.
- When you are using software such as “Easy CD Creator” to burn the jpeg files into the CD-R, ensure that all the selected files have the “.jpg” extensions when copying into the CD layout.
- If the files have “.jpe” or “.jpeg” extensions, please rename them as “.jpg” files.
- File names without “.jpg” extension will not be able to be read by this DVD+VCR. Even though the files are shown as JPEG image files in windows explorer.

Programmed Playback with Audio CDs and MP3/WMA Discs

The Program function enables you to store your favorite tracks from any disc in the player memory.

Program can contain 30 tracks.

1 Press PROGRAM during playback or in the Stop mode to enter the Program Edit mode.

The [E] mark will appear to the right of the word Program on the right side of the menu screen.

Note

Press PROGRAM to exit the Program Edit mode; the [E] mark will disappear.

2 Select a track, then press ENTER to place the selected track on the Program list.

3 Repeat step 2 to place additional tracks on the Program list.

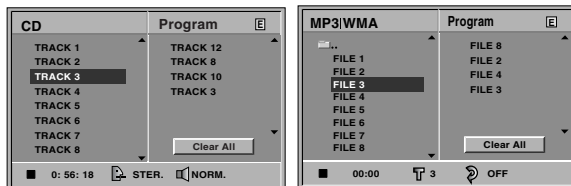

Audio CD Menu

MP3/WMA Menu

4 Press ►.

The programmed track you selected last is highlighted on the program list.

5 Use ▲/▼ to select the track you want to start playing.

Press TITLE to move to the next page.
Press DISC MENU to move to the previous page.

6 Press ► (PLAY) to start.

Playback begins in the order in which you programmed the tracks and "PROG." appears on the menu screen. Playback stops after all of the tracks on the Program list have played once.

7 To resume normal playback from programmed playback, press PROGRAM.

Select a track of CD (or MP3/WMA) list and then press ENTER.

"PROG." indicator disappears from the menu screen.

Repeat Programmed Tracks

- To repeat the track currently playing, press REPEAT. The Repeat icon and "TRACK" appear on the menu screen.
- To repeat all tracks on the program list, press REPEAT a second time. The Repeat icon and "ALL" appear on the menu screen.
- To cancel Repeat mode, press REPEAT a third time. The Repeat icon and "OFF" appear on the menu screen.

Erasing a Track from the Program List

1 Press PROGRAM during playback or in the Stop mode to enter the Program Edit mode.

The [E] mark will appear.

2 Press ► to move to the Program list.

3 Use ▲/▼ to select the track that you wish to erase from the Program list.

4 Press CLEAR.

The track will be erased from the Program list.

Erasing the Complete Program List

1 Follow steps 1-2 of "Erasing a Track from the Program List" shown above.

2 Use ▲/▼ to select "Clear All", then press ENTER.

The complete Program for the disc will be erased. The programs are also cleared if the disc is ejected.

Controlling Your TV with the Supplied Remote

You can control the sound level, input source, and power switch of your LG TV with the supplied remote.

You can control your TV using the buttons below.

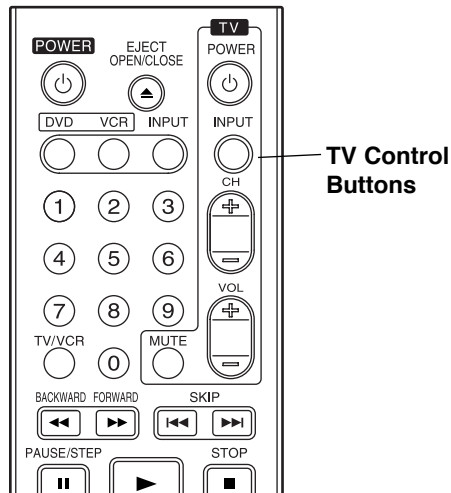

By pressing	You can
POWER	Turn the TV on or off.
INPUT	Switch the TV's input source between the TV and other input sources.
CH +/-	Scans up or down through memorized channels.
VOL +/-	Adjust the volume of the TV.
MUTE	Turns on or off TV sound.

Note

Depending on the unit being connected, you may not be able to control your TV using some of the buttons.

Controlling other TVs with the remote

You can control the sound level, input source, and power switch of non-LG TVs as well. If your TV is listed in the table below, set the appropriate manufacturer code.

1. While holding down TV POWER button, press the number buttons to select the manufacturer code for your TV (see the table below).
2. Release TV POWER button.

Code numbers of controllable TVs

If more than one code number is listed, try entering them one at a time until you find the one that works with your TV.

Manufacturer	Code Number
LG / GoldStar	1 (Default), 2
Zenith	1, 3, 4
Samsung	6, 7
Sony	8, 9
Hitachi	4

Notes

- Depending on your TV, some or all buttons may not function on the TV, even after entering the correct manufacturer code.
- If you enter a new code number, the code number previously entered will be erased.
- When you replace the batteries of the remote, the code number you have set may be reset to the default setting. Set the appropriate code number again.

Troubleshooting

Check the following guide for the possible cause of a problem before contacting service.

Symptom	Cause	Correction
No power.	<ul style="list-style-type: none"> The power cord is disconnected. 	<ul style="list-style-type: none"> Plug the power cord into the wall outlet securely.
The power is on, but the DVD+VCR does not work.	<ul style="list-style-type: none"> No disc is inserted. No tape is inserted. 	<ul style="list-style-type: none"> Insert a disc or tape. (Check that the disc or tape indicator in the display window is lit.)
No picture.	<ul style="list-style-type: none"> The TV is not set to receive DVD+VCR signal output. 	<ul style="list-style-type: none"> Select the appropriate video input mode on the TV so the picture from the DVD+VCR appears on the TV screen.
	<ul style="list-style-type: none"> TV/VCR mode for DVD+VCR is set to TV. 	<ul style="list-style-type: none"> Press the TV/VCR button on the remote control repeatedly to choose VCR mode. TV indicator disappears from the display window.
	<ul style="list-style-type: none"> The video cable is not connected securely. 	<ul style="list-style-type: none"> Connect the video cable securely.
	<ul style="list-style-type: none"> The connected TV power is turned off. 	<ul style="list-style-type: none"> Turn on the TV.
No sound.	<ul style="list-style-type: none"> The equipment connected with the audio cable is not set to receive DVD+VCR signal output. 	<ul style="list-style-type: none"> Select the correct input mode on the audio receiver so you can listen to the sound from the DVD+VCR.
	<ul style="list-style-type: none"> The audio cables are not connected securely. 	<ul style="list-style-type: none"> Connect the audio cables securely.
	<ul style="list-style-type: none"> The power of the equipment connected with the audio cables is turned off. 	<ul style="list-style-type: none"> Turn on the equipment connected with the audio cables.
	<ul style="list-style-type: none"> The Digital Audio Output is set to the wrong position. 	<ul style="list-style-type: none"> Set the Digital Audio Output to the correct position, then turn on the DVD+VCR again by pressing POWER.
The playback picture is poor.	<ul style="list-style-type: none"> The disc is dirty. 	<ul style="list-style-type: none"> Clean the disc.
	<ul style="list-style-type: none"> Tape heads are dirty. 	<ul style="list-style-type: none"> Clean video heads.
	<ul style="list-style-type: none"> Tape is a rental or was recorded on another VCR. 	<ul style="list-style-type: none"> Use CH/TRK (▲/▼) for manual tracking adjustment while tape is playing.
The DVD+VCR does not start playback.	<ul style="list-style-type: none"> No disc is inserted. No tape is inserted. 	<ul style="list-style-type: none"> Insert a disc or tape. (Check that the disc or tape indicator in the display window is lit.)
	<ul style="list-style-type: none"> An unplayable disc is inserted. 	<ul style="list-style-type: none"> Insert a playable disc. (Check the disc type, color system, and Regional code.)
	<ul style="list-style-type: none"> The disc is placed upside down. 	<ul style="list-style-type: none"> Place the disc with the playback side down.
	<ul style="list-style-type: none"> The disc is not placed within the guide. 	<ul style="list-style-type: none"> Place the disc on the disc tray correctly inside the guide.
	<ul style="list-style-type: none"> The disc is dirty. 	<ul style="list-style-type: none"> Clean the disc.
	<ul style="list-style-type: none"> The Rating level is set. 	<ul style="list-style-type: none"> Cancel the Rating function or change the rating level.
The remote control does not work properly.	<ul style="list-style-type: none"> The remote control is not pointed at the remote sensor of the DVD+VCR. 	<ul style="list-style-type: none"> Point the remote control at the remote sensor of the DVD+VCR.
	<ul style="list-style-type: none"> The remote control is too far from the DVD+VCR. 	<ul style="list-style-type: none"> Operate the remote control within 23 ft (7 m).
	<ul style="list-style-type: none"> There is an obstacle in the path of the remote control and the DVD+VCR. 	<ul style="list-style-type: none"> Remove the obstacle.
	<ul style="list-style-type: none"> The batteries in the remote control are dead. 	<ul style="list-style-type: none"> Replace the batteries with new ones.
	<ul style="list-style-type: none"> This remote control uses the same buttons for VCR and DVD functions (ex. PLAY). 	<ul style="list-style-type: none"> When using a VCR, first press the VCR button. When using a DVD, first press the DVD button.

Troubleshooting (Continued)

Symptom	Cause	Correction
Some channels are skipped over when using CH/TRK (▲/▼)	<ul style="list-style-type: none"> Those channels were deleted with the CH. ADD/DEL option. 	<ul style="list-style-type: none"> Use CH. ADD/DEL. to restore channels. See "Channel Selection" on page 15.
Picture and sound of broadcasting channel are weak or missing.	<ul style="list-style-type: none"> Antenna or cables are loose. 	<ul style="list-style-type: none"> Tighten connections or replace cable.
	<ul style="list-style-type: none"> Wrong TUNING BAND option is being used. 	<ul style="list-style-type: none"> Try all TUNING BAND options. See "Channel Selection" on page 15 for details.
Camcorder image is not shown.	<ul style="list-style-type: none"> Camcorder is off. 	<ul style="list-style-type: none"> Turn camcorder on and operate properly.
Camcorder image via A/V input to DVD+VCR is not shown on TV screen.	<ul style="list-style-type: none"> DVD+VCR SOURCE SELECT is not set to LINE1 or LINE2. 	<ul style="list-style-type: none"> Press INPUT to select LINE input channel (LINE1 or LINE2).
Timer recording is not possible.	<ul style="list-style-type: none"> Clock in DVD+VCR is not set to correct time. 	<ul style="list-style-type: none"> Set clock to correct time. See "Setting the Clock" on page 16.
	<ul style="list-style-type: none"> Timer has been programmed incorrectly. 	<ul style="list-style-type: none"> Reprogram Timer. See "Timer Recording" on pages 22 and 23.
	<ul style="list-style-type: none"> ⌚ indicator does not appear after programming timer. 	<ul style="list-style-type: none"> Reprogram Timer.
⌚ indicator appears after DVD+VCR is turned off.	<ul style="list-style-type: none"> DVD+VCR is in Timer Recording mode. 	<ul style="list-style-type: none"> This is the normal indication that the DVD+VCR is in TIMER mode.
Stereo Audio Record and/or Playback is not present.	<ul style="list-style-type: none"> TV is not Stereo-compatible. 	<ul style="list-style-type: none"> No action is possible.
	<ul style="list-style-type: none"> Broadcast program is not in stereo format. 	<ul style="list-style-type: none"> No action is possible.
	<ul style="list-style-type: none"> DVD+VCR A/V Out jacks are not connected to TV A/V In jacks. 	<ul style="list-style-type: none"> Make A/V connections. Stereo is available only via A/V output from DVD+VCR.
	<ul style="list-style-type: none"> DVD+VCR Audio/Video Out is not selected for viewing at the TV. 	<ul style="list-style-type: none"> Select AUX or A/V source as TV input.
	<ul style="list-style-type: none"> DVD+VCR BROADCAST TYPE mode is set to SAP or MONO. 	<ul style="list-style-type: none"> Set BROADCAST TYPE mode to STEREO. See "VCR Setup Menu Options" on page 15.

Moisture Condensation

Moisture condensation can occur:	In locations where moisture condensation may occur:
<ul style="list-style-type: none"> When the DVD+VCR is moved from a cold place to a warm place. Under extremely humid conditions. 	<ul style="list-style-type: none"> Keep the DVD+VCR plugged into an AC power outlet with POWER On. This will help prevent condensation. When condensation has occurred, wait a few hours for the DVD+VCR to dry before using it.

Language Code List

Enter the appropriate code number for the initial settings “Disc Audio”, “Disc Subtitle” and/or “Disc Menu” (See page 18).

Language	Code	Language	Code	Language	Code	Language	Code
Abkhazian	6566	Fiji	7074	Lingala	7678	Singhalese	8373
Afar	6565	Finnish	7073	Lithuanian	7684	Slovak	8375
Afrikaans	6570	French	7082	Macedonian	7775	Slovenian	8376
Albanian	8381	Frisian	7089	Malagasy	7771	Somali	8379
Amharic	6577	Galician	7176	Malay	7783	Spanish	6983
Arabic	6582	Georgian	7565	Malayalam	7776	Sudanese	8385
Armenian	7289	German	6869	Maltese	7784	Swahili	8387
Assamese	6583	Greek	6976	Maori	7773	Swedish	8386
Aymara	6588	Greenlandic	7576	Marathi	7782	Tagalog	8476
Azerbaijani	6590	Guarani	7178	Moldavian	7779	Tajik	8471
Bashkir	6665	Gujarati	7185	Mongolian	7778	Tamil	8465
Basque	6985	Hausa	7265	Nauru	7865	Tatar	8484
Bengali; Bangla	6678	Hebrew	7387	Nepali	7869	Telugu	8469
Bhutani	6890	Hindi	7273	Norwegian	7879	Thai	8472
Bihari	6672	Hungarian	7285	Oriya	7982	Tibetan	6679
Breton	6682	Icelandic	7383	Panjabi	8065	Tigrinya	8473
Bulgarian	6671	Indonesian	7378	Pashto, Pushto	8083	Tonga	8479
Burmese	7789	Interlingua	7365	Persian	7065	Turkish	8482
Byelorussian	6669	Irish	7165	Polish	8076	Turkmen	8475
Cambodian	7577	Italian	7384	Portuguese	8084	Twi	8487
Catalan	6765	Japanese	7465	Quechua	8185	Ukrainian	8575
Chinese	9072	Javanese	7487	Rhaeto-Romance	8277	Urdu	8582
Corsican	6779	Kannada	7578	Romanian	8279	Uzbek	8590
Croatian	7282	Kashmiri	7583	Russian	8285	Vietnamese	8673
Czech	6783	Kazakh	7575	Samoaan	8377	Volapük	8679
Danish	6865	Kirghiz	7589	Sanskrit	8365	Welsh	6789
Dutch	7876	Korean	7579	Scots Gaelic	7168	Wolof	8779
English	6978	Kurdish	7585	Serbian	8382	Xhosa	8872
Esperanto	6979	Laothian	7679	Serbo-Croatian	8372	Yiddish	7473
Estonian	6984	Latin	7665	Shona	8378	Yoruba	8979
Faeroese	7079	Latvian, Lettish	7686	Sindhi	8368	Zulu	9085

Country Code List

Enter the appropriate code number for the initial setting "Country Code" (See page 20).

Code	Country	Code	Country	Code	Country	Code	Country
AD	Andorra	ER	Eritrea	LC	Saint Lucia	SC	Seychelles
AE	United Arab Emirates	ES	Spain	LI	Liechtenstein	SD	Sudan
AF	Afghanistan	ET	Ethiopia	LK	Sri Lanka	SE	Sweden
AG	Antigua and Barbuda	FI	Finland	LR	Liberia	SG	Singapore
AI	Anguilla	FJ	Fiji	LS	Lesotho	SH	Saint Helena
AL	Albania	FK	Falkland Islands	LT	Lithuania	SI	Slovenia
AM	Armenia	FM	Micronesia	LU	Luxembourg	SJ	Svalbard and Jan Mayen Islands
AN	Netherlands Antilles	FO	Faroe Islands	LV	Latvia	SK	Slovak Republic
AO	Angola	FR	France	LY	Libya	SL	Sierra Leone
AQ	Antarctica	FX	France (European Territory)	MA	Morocco	SM	San Marino
AR	Argentina	GA	Gabon	MC	Monaco	SN	Senegal
AS	American Samoa	GB	Great Britain	MD	Moldavia	SO	Somalia
AT	Austria	GD	Grenada	MG	Madagascar	SR	Suriname
AU	Australia	GE	Georgia	MH	Marshall Islands	ST	Saint Tome and Principe
AW	Aruba	GF	French Guyana	MK	Macedonia	SU	Former USSR
AZ	Azerbaijan	GH	Ghana	ML	Mali	SV	El Salvador
BA	Bosnia-Herzegovina	GI	Gibraltar	MM	Myanmar	SY	Syria
BB	Barbados	GL	Greenland	MN	Mongolia	SZ	Swaziland
BD	Bangladesh	GM	Gambia	MO	Macau	TC	Turks and Caicos Islands
BE	Belgium	GN	Guinea	MP	Northern Mariana Islands	TD	Chad
BF	Burkina Faso	GP	Guadeloupe (French)	MQ	Martinique (French)	TF	French Southern Territories
BG	Bulgaria	GQ	Equatorial Guinea	MR	Mauritania	TG	Togo
BH	Bahrain	GR	Greece	MS	Montserrat	TH	Thailand
BI	Burundi	GS	S. Georgia & S. Sandwich Isls.	MT	Malta	TJ	Tadjikistan
BJ	Benin	GT	Guatemala	MU	Mauritius	TK	Tokelau
BM	Bermuda	GU	Guam (USA)	MV	Maldives	TM	Turkmenistan
BN	Brunei Darussalam	GW	Guinea Bissau	MY	Malaysia	TN	Tunisia
BO	Bolivia	GY	Guyana	MZ	Mozambique	TO	Tonga
BR	Brazil	HK	Hong Kong	NA	Namibia	TP	East Timor
BS	Bahamas	HM	Heard and McDonald Islands	NC	New Caledonia (French)	TR	Turkey
BT	Bhutan	HN	Honduras	NE	Niger	TT	Trinidad and Tobago
BV	Bouvet Island	HR	Croatia	NF	Norfolk Island	TV	Tuvalu
BW	Botswana	HT	Haiti	NG	Nigeria	TW	Taiwan
BY	Belarus	HU	Hungary	NI	Nicaragua	TZ	Tanzania
BZ	Belize	ID	Indonesia	NL	Netherlands	UA	Ukraine
CA	Canada	IE	Ireland	NO	Norway	UG	Uganda
CC	Cocos (Keeling) Islands	IL	Israel	NP	Nepal	UK	United Kingdom
CD	Central African Republic	IN	India	NR	Nauru	UM	USA Minor Outlying Islands
CG	Congo	IO	British Indian Ocean Territory	NU	Niue	US	United States
CH	Switzerland	IQ	Iraq	NZ	New Zealand	UY	Uruguay
CI	Ivory Coast	IR	Iran	OM	Oman	UZ	Uzbekistan
CK	Cook Islands	IS	Iceland	PA	Panama	VA	Vatican City State
CL	Chile	IT	Italy	PE	Peru	VC	Saint Vincent & Grenadines
CM	Cameroon	JM	Jamaica	PF	Polynesia (French)	VE	Venezuela
CN	China	JO	Jordan	PG	Papua New Guinea	VG	Virgin Islands (British)
CO	Colombia	JP	Japan	PH	Philippines	VI	Virgin Islands (USA)
CR	Costa Rica	KE	Kenya	PK	Pakistan	VN	Vietnam
CS	Former Czechoslovakia	KG	Kyrgyzstan	PL	Poland	VU	Vanuatu
CU	Cuba	KH	Kyrgyzstan	PM	Saint Pierre and Miquelon	WF	Wallis and Futuna Islands
CV	Cape Verde	KI	Kiribati	PR	Puerto Rico	WS	Samoa
CX	Christmas Island	KM	Comoros	PT	Portugal	YE	Yemen
CY	Cyprus	KN	Saint Kitts & Nevis Anguilla	PW	Palau	YT	Mayotte
CZ	Czech Republic	KP	North Korea	PY	Paraguay	YU	Yugoslavia
DE	Germany	KR	South Korea	QA	Qatar	ZA	South Africa
DJ	Djibouti	KW	Kuwait	RE	Reunion (French)	ZM	Zambia
DK	Denmark	KY	Cayman Islands	RO	Romania	ZR	Zaire
DM	Dominica	KZ	Kazakhstan	RU	Russian Federation	ZW	Zimbabwe
DO	Dominican Republic	LA	Laos	RW	Rwanda		
DZ	Algeria	LB	Lebanon	SA	Saudi Arabia		
EC	Ecuador			SB	Solomon Islands		
EE	Estonia						
EG	Egypt						
EH	Western Sahara						

Specifications

General

Power requirements	AC 120V, 60 Hz
Power consumption	19 W
Dimensions (approx.)	16.9" X 3.1" X 10.8" (430 X 78.5 X 273 mm) (w x h x d)
Weight (approx.)	8.82 lbs (4.0 kg)
Operating temperature	5°C to 40°C (41°F to 104°F)
Operating humidity	5 % to 90 %
Signal system	NTSC

Inputs

ANTENNA IN	75 ohms (VHF/UHF/CATV)
VHS VIDEO IN(LINE1, 2)	1 V (p-p) 75 ohms, sync negative, RCA jack x 2
VHS AUDIO IN(LINE1, 2)	-6.0 dBm more than 47 ohms, RCA jack (L, R) x 2

Outputs

VIDEO OUT	1 V (p-p) 75 ohms, sync negative
S-VIDEO OUT	(Y) 1.0 V (p-p), 75 ohms, negative sync, Mini DIN 4-pin x 1 (C) 0.286 V (p-p) 75 ohms
COMPONENT VIDEO OUT (PROGRESSIVE SCAN)	(Y) 1.0 V (p-p), 75 ohms, negative sync, RCA jack x 1 (Pb)/(Pr) 0.7 V (p-p), 75 ohms, RCA jack x 2
Audio output (digital audio)	0.5 V (p-p), 75 ohms, RCA jack x 1
Audio output (analog audio)	2.0 Vrms (1 KHz, 0 dB), 600 ohms, RCA jack (L, R) x 1
RF OUT	Channel 3 or 4 (Switchable)

VCR Specifications

Head system	Four head helical scan azimuth system
Timer	12-hour display type with AM, PM
Tape speed	SP: 33.35 mm/sec, LP: 16.67 mm/sec, SLP: 11.12 mm/sec
Tape width	12.7 mm
Maximum recording time	SP: 2 HOURS (T-120), SLP: 6 HOURS (T-120)/8 HOURS (T-160)
Rewind time	About 3 minutes (T-120)
Channel coverage	VHF: 2-13, UHF: 14-69, CATV: 1-125 (4A, A-W, W+1 - W+84, A-5 - A-1)
Frequency range	20 Hz to 20 kHz
Signal-to-noise ratio	More than 43 dB
Dynamic range	More than 88 dB
Channel separation	More than 60 dB

DVD Specifications

Laser system	Semiconductor laser, wavelength 650 nm
Frequency response	DVD (PCM 96 kHz): 8 Hz to 44 kHz, DVD (PCM 48 kHz): 8 Hz to 22 kHz CD: 8 Hz to 20 kHz
Signal-to-noise ratio	More than 100 dB (ANALOG OUT jacks only)
Harmonic distortion	Less than 0.008%
Dynamic range	More than 95 dB (DVD/CD)

Accessories:

Video cable x 1, Audio cable x 1, RF 75-ohm Coaxial Cable x 1, Remote control x 1, Batteries (AAA) x 2

- Design and specifications are subject to change without prior notice.

GOLDSTAR DVD/VCR LIMITED WARRANTY - USA

The manufacturer will repair or replace your product, at the manufacturer's option, if it proves to be defective in material or workmanship under normal use, during the warranty period ("Warranty Period") listed below, effective from the date ("Date of Installation") of original consumer purchase of the product. This warranty is good only to the original purchaser of the product and effective only when used in the United States, excluding U.S. Territories.

<p>WARRANTY PERIOD:</p> <p>LABOR: 90 DAYS from the Date of Purchase.</p> <p>PARTS: ONE YEAR from the Date of Purchase.</p> <p>Replacement Units is warranted for the remaining period of the original warranty.</p>	<p>HOW SERVICE IS HANDLED:</p> <p>This is an Exchange Product. Call 1-877-714-7486 for instructions on getting the defective unit replaced.</p> <p>Please retain dated sales receipt and your box to return the unit for replacement.</p> <p>During the first 90 days of the Warranty Period, shipping charges both ways will be paid by the manufacturer. During the remainder of the Warranty Period (91-365 days), you pay in-bound shipping charges and the manufacturer pays return shipping charges.</p> <p>Visit our website at http://us.lgservice.com</p>
---	---

THIS WARRANTY IS IN LIEU OF ANY OTHER WARRANTIES, EXPRESS OR IMPLIED, INCLUDING WITHOUT LIMITATION, ANY WARRANTY OF MERCHANTABILITY OR FITNESS FOR A PARTICULAR PURPOSE. TO THE EXTENT ANY IMPLIED WARRANTY IS REQUIRED BY LAW, IT IS LIMITED IN DURATION TO THE EXPRESS WARRANTY PERIOD ABOVE. LG WILL NOT BE LIABLE FOR ANY CONSEQUENTIAL, INDIRECT, OR INCIDENTAL DAMAGES OF ANY KIND, INCLUDING LOST REVENUES OR PROFITS, IN CONNECTION WITH THE PRODUCT. SOME STATES DO NOT ALLOW LIMITATION ON HOW LONG AN IMPLIED WARRANTY LASTS OR THE EXCLUSION OF INCIDENTAL OR CONSEQUENTIAL DAMAGES, SO THE ABOVE LIMITATIONS OR EXCLUSIONS MAY NOT APPLY TO YOU.

THIS LIMITED WARRANTY DOES NOT APPLY TO:

- Damages or operating problems that result from shipping, installation, adjustment of user controls, calibration, maintenance or failure to maintain, or separate system components; and
- Damages or operating problems that result from normal wear and tear, misuse, abuse, operation outside environmental specifications or contrary to the requirements or precautions in the Operating Guide, accident, lightning strikes or other natural causes, unauthorized modification or alteration, incorrect electrical current or voltage, signal reception or input, software not licensed directly by LG, software errors that do not disable functionality, operating and software protocols adopted after the date of manufacture or for outside the US, institutional or commercial use, or other causes not arising out of defect in material or workmanship.

The cost of repair or replacement under these excluded circumstances shall be borne by the consumer.

CUSTOMER INTER-ACTIVE CENTER NUMBERS:

<p>For Where to buy, Product Assistance, or Customer Assistance</p>	<p>Call 1-877-714-7486 (24 hours a day, 365 days per year) and select appropriate options from the menu.</p> <p>Or visit our website at http://us.lgservice.com</p>
--	--

FOR WARRANTY SERVICE:

You must call 1-877-714-7486 (24 hours a day, 365 days per year) and select an appropriate option from the menu to confirm the product is defective and to obtain a Return Authorization (RA). If the defect has occurred during the first 90 days of the Warranty Period, you will be sent a return-shipping label. After you obtain an RA for return, please box your unit with a legible copy of the sales receipt and enough packing material to ensure undamaged delivery of your product. When you receive the label, place it on the box and call the 800# in the instructions for pick-up. When your unit is received, the manufacturer will replace your unit in accordance with this Limited Warranty.

ADVANCE SHIPMENT. If a replacement unit is available and you want second day delivery, our service representative will ask for your credit card number. A reserved deposit by credit card is required as surety for such advance shipment. Your credit card will not be charged if you return the defective unit in 10 business days. For advance shipment, the return label will come with the replacement unit sent to you. Please follow boxing and shipping instructions above.

Marketed and distributed by:
LG ELECTRONICS U.S.A., INC.
1000 SYLVAN AVENUE
ENGLEWOOD CLIFFS, NJ

GS# 3835RV0016K
Printed in Indonesia
Issue O

Free Manuals Download Website

<http://myh66.com>

<http://usermanuals.us>

<http://www.somanuals.com>

<http://www.4manuals.cc>

<http://www.manual-lib.com>

<http://www.404manual.com>

<http://www.luxmanual.com>

<http://aubethermostatmanual.com>

Golf course search by state

<http://golfingnear.com>

Email search by domain

<http://emailbydomain.com>

Auto manuals search

<http://auto.somanuals.com>

TV manuals search

<http://tv.somanuals.com>