

## User's Manual



### *RGB 500/Dual, RGB 508, RGB 560/Dual, RGB 568*

Architectural Series Universal Interfaces with Audio and ADSP™



Extron Electronics, USA  
1230 South Lewis Street, Anaheim, CA 92805  
800.633.9876 714.491.1500 FAX 714.491.1517  
USA

Extron Electronics, Europe  
Beeldschermweg 6C, 3821 AH Amersfoort  
+31.33.453.4040 FAX +31.33.453.4050  
The Netherlands

Extron Electronics, Asia  
135 Joo Seng Rd. #04-01, PM Industrial Bldg.  
+65.383.4400 FAX +65.383.4664  
Singapore 368363

Extron Electronics Information  
ExtronWEB™: [www.extron.com](http://www.extron.com)  
ExtronFAX™: 714.491.0192  
24-hour access—worldwide!

# Precautions

## Safety Instructions • English



This symbol is intended to alert the user of important operating and maintenance (servicing) instructions in the literature provided with the equipment.



This symbol is intended to alert the user of the presence of uninsulated dangerous voltage within the product's enclosure that may present a risk of electric shock.

## Caution

- Read Instructions** • Read and understand all safety and operating instructions before using the equipment.
- Retain Instructions** • The safety instructions should be kept for future reference.
- Follow Warnings** • Follow all warnings and instructions marked on the equipment or in the user information.
- Avoid Attachments** • Do not use tools or attachments that are not recommended by the equipment manufacturer because they may be hazardous.

## Consignes de Sécurité • Français



Ce symbole sert à avertir l'utilisateur que la documentation fournie avec le matériel contient des instructions importantes concernant l'exploitation et la maintenance (réparation).



Ce symbole sert à avertir l'utilisateur de la présence dans le boîtier de l'appareil de tensions dangereuses non isolées posant des risques d'électrocution.

## Attention

- Lire les instructions** • Prendre connaissance de toutes les consignes de sécurité et d'exploitation avant d'utiliser le matériel.
- Conservier les instructions** • Ranger les consignes de sécurité afin de pouvoir les consulter à l'avenir.
- Respecter les avertissements** • Observer tous les avertissements et consignes marqués sur le matériel ou présentés dans la documentation utilisateur.
- Eviter les pièces de fixation** • Ne pas utiliser de pièces de fixation ni d'outils non recommandés par le fabricant du matériel car cela risquerait de poser certains dangers.

## Sicherheitsanleitungen • Deutsch



Dieses Symbol soll den Benutzer auf wichtige Anleitungen zur Bedienung und Wartung (Instandhaltung) in der Dokumentation hinweisen, die im Lieferumfang dieses Gerätes enthalten ist.



Dieses Symbol soll den Benutzer darauf aufmerksam machen, daß im Inneren des Gehäuses dieses Produktes gefährliche Spannungen, die nicht isoliert sind und die einen elektrischen Schock verursachen können, herrschen.

## Achtung

- Lesen der Anleitungen** • Bevor Sie das Gerät zum ersten Mal verwenden, sollten Sie alle Sicherheits- und Bedienungsanleitungen genau durchlesen und verstehen.
- Aufbewahren der Anleitungen** • Die Sicherheitsanleitungen sollten aufbewahrt werden, damit Sie später darauf zurückgreifen können.
- Befolgen der Warnhinweise** • Befolgen Sie alle Warnhinweise und Anleitungen auf dem Gerät oder in der Benutzerdokumentation.
- Keine Zusatzgeräte** • Verwenden Sie keine Werkzeuge oder Zusatzgeräte, die nicht ausdrücklich vom Hersteller empfohlen wurden, da diese eine Gefahrenquelle darstellen können.

## Instrucciones de seguridad • Español



Este símbolo se utiliza para advertir al usuario sobre instrucciones importantes de operación y mantenimiento (o cambio de partes) que se desean destacar en el contenido de la documentación suministrada con los equipos.



Este símbolo se utiliza para advertir al usuario sobre la presencia de elementos con voltaje peligroso sin protección aislante, que puedan encontrarse dentro de la caja o alojamiento del producto, y que puedan representar riesgo de electrocución.

## Precaucion

- Leer las instrucciones** • Leer y analizar todas las instrucciones de operación y seguridad, antes de usar el equipo.
- Conservar las instrucciones** • Conservar las instrucciones de seguridad para futura consulta.
- Obedecer las advertencias** • Todas las advertencias e instrucciones marcadas en el equipo o en la documentación del usuario, deben ser obedecidas.
- Evitar el uso de accesorios** • No usar herramientas o accesorios que no sean específicamente recomendados por el fabricante, ya que podrían implicar riesgos.

## Warning

- Power sources** • This equipment should be operated only from the power source indicated on the product. This equipment is intended to be used with a main power system with a grounded (neutral) conductor. The third (grounding) pin is a safety feature, do not attempt to bypass or disable it.
- Power disconnection** • To remove power from the equipment safely, remove all power cords from the rear of the equipment, or the desktop power module (if detachable), or from the power source receptacle (wall plug).
- Power cord protection** • Power cords should be routed so that they are not likely to be stepped on or pinched by items placed upon or against them.
- Servicing** • Refer all servicing to qualified service personnel. There are no user-serviceable parts inside. To prevent the risk of shock, do not attempt to service this equipment yourself because opening or removing covers may expose you to dangerous voltage or other hazards.
- Slots and openings** • If the equipment has slots or holes in the enclosure, these are provided to prevent overheating of sensitive components inside. These openings must never be blocked by other objects.
- Lithium battery** • There is a danger of explosion if battery is incorrectly replaced. Replace it only with the same or equivalent type recommended by the manufacturer. Dispose of used batteries according to the manufacturer's instructions.

## Avertissement

- Alimentations** • Ne faire fonctionner ce matériel qu'avec la source d'alimentation indiquée sur l'appareil. Ce matériel doit être utilisé avec une alimentation principale comportant un fil de terre (neutre). Le troisième contact (de mise à la terre) constitue un dispositif de sécurité : n'essayez pas de le contourner ni de le désactiver.
- Déconnexion de l'alimentation** • Pour mettre le matériel hors tension sans danger, déconnectez tous les cordons d'alimentation de l'arrière de l'appareil ou du module d'alimentation de bureau (s'il est amovible) ou encore de la prise secteur.
- Protection du cordon d'alimentation** • Acheminer les cordons d'alimentation de manière à ce que personne ne risque de marcher dessus et à ce qu'ils ne soient pas écrasés ou pincés par des objets.
- Réparation-maintenance** • Faire exécuter toutes les interventions de réparation-maintenance par un technicien qualifié. Aucun des éléments internes ne peut être réparé par l'utilisateur. Afin d'éviter tout danger d'électrocution, l'utilisateur ne doit pas essayer de procéder lui-même à des opérations car l'ouverture ou le retrait des couvercles risquent de l'exposer à de hautes tensions et autres dangers.
- Fentes et orifices** • Si le boîtier de l'appareil comporte des fentes ou des orifices, ceux-ci servent à empêcher les composants internes sensibles de surchauffer. Ces ouvertures ne doivent jamais être bloquées par des objets.
- Lithium Batterie** • Il a danger d'explosion s'il y a un remplacement incorrect de la batterie. Remplacer uniquement avec une batterie du même type ou d'un type équivalent recommandé par le constructeur. Mettre au rebut les batteries usagées conformément aux instructions du fabricant.

## Vorsicht

- Stromquellen** • Dieses Gerät sollte nur über die auf dem Produkt angegebene Stromquelle betrieben werden. Dieses Gerät wurde für eine Verwendung mit einer Hauptstromleitung mit einem geerdeten (neutralen) Leiter konzipiert. Der dritte Stift oder Kontakt ist für einen Erdschluß und stellt eine Sicherheitsfunktion dar und sollte nicht umgangen oder außer Betrieb gesetzt werden.
- Stromunterbrechung** • Um das Gerät auf sichere Weise vom Netz zu trennen, sollten Sie alle Netzkabeln aus der Rückseite des Gerätes oder aus dem Desktop-Strommodul (falls dies möglich ist) oder aus der Wandsteckdose ziehen.
- Schutz des Netzkabels** • Netzkabel sollten stets so verlegt werden, daß sie nicht im Weg liegen und niemand darauf treten kann oder Objekte darauf- oder unmittelbar dagegengestellt werden können.
- Wartung** • Alle Wartungsmaßnahmen sollten nur von qualifiziertem Servicepersonal durchgeführt werden. Im Inneren des Gerätes sind keine Teile enthalten, die vom Benutzer gewartet werden können. Zur Vermeidung eines elektrischen Schocks versuchen Sie in keinem Fall, dieses Gerät selbst zu warten, da beim Öffnen oder Entfernen der Abdeckungen die Gefahr eines elektrischen Schlags oder andere Gefahren bestehen.
- Schlitze und Öffnungen** • Wenn das Gerät Schlitze oder Löcher im Gehäuse aufweist, dienen diese zur Vermeidung einer Überhitzung der empfindlichen Teile im Inneren. Diese Öffnungen dürfen niemals von anderen Objekten blockiert werden.
- Lithium-Batterie** • Explosionsgefahr, falls die Batterie nicht richtig ersetzt wird. Ersetzen Sie nur durch diegleiche oder einen vergleichbaren Batteriepty, der auch vom Hersteller empfohlen wird. Entsorgung der verbrauchten Batterien bitte gemäß den Herstelleranweisungen.

## Advertencia

- Alimentación eléctrica** • Este equipo debe conectarse únicamente a la fuente/tipo de alimentación eléctrica indicada en el mismo. La alimentación eléctrica de este equipo debe provenir de un sistema de distribución general con conductor neutro a tierra. La tercera pata (puesta a tierra) es una medida de seguridad, no puentearla ni eliminarla.
- Desconexión de alimentación eléctrica** • Para desconectar con seguridad la alimentación de alimentación eléctrica al equipo, desenchufar todos los cables de alimentación en el panel trasero del equipo, o desenchufar el módulo de alimentación (si fuera independiente), o desenchufar el cable del receptáculo de la pared.
- Protección del cables de alimentación** • Los cables de alimentación eléctrica se deben instalar en lugares donde no sean pisados ni apretados por objetos que se puedan apoyar sobre ellos.
- Reparaciones/mantenimiento** • Solicitar siempre los servicios técnicos de personal calificado. En el interior no hay partes a las que el usuario deba acceder. Para evitar riesgo de electrocución, no intentar personalmente la reparación/mantenimiento de este equipo, ya que al abrir o extraer las tapas puede quedar expuesto a voltajes peligrosos u otros riesgos.
- Ranuras y aberturas** • Si el equipo posee ranuras o orificios en su caja/alojamiento, es para evitar el sobrecalentamiento de componentes internos sensibles. Estas aberturas nunca se deben obstruir con otros objetos.
- Batería de litio** • Existe riesgo de explosión si esta batería se coloca en la posición incorrecta. Cambiar esta batería únicamente con el mismo tipo (o su equivalente) recomendado por el fabricante. Desachar las baterías usadas siguiendo las instrucciones del fabricante.

# FCC Class A Notice

Note: This equipment has been tested and found to comply with the limits for a Class A digital device, pursuant to part 15 of the FCC Rules. These limits are designed to provide reasonable protection against harmful interference when the equipment is operated in a commercial environment. This equipment generates, uses and can radiate radio frequency energy and, if not installed and used in accordance with the instruction manual, may cause harmful interference to radio communications. Operation of this equipment in a residential area is likely to cause harmful interference, in which case the user will be required to correct the interference at his own expense.

Note: This unit was tested with shielded cables on the peripheral devices. Shielded cables must be used with the unit to ensure compliance.

# Extron's Warranty

Extron Electronics warrants this product against defects in materials and workmanship for a period of two years from the date of purchase. In the event of malfunction during the warranty period attributable directly to faulty workmanship and/or materials, Extron Electronics will, at its option, repair or replace said products or components, to whatever extent it shall deem necessary to restore said product to proper operating condition, provided that it is returned within the warranty period, with proof of purchase and description of malfunction to:

USA, Canada, South America, and Central America:	Europe, Africa, and the Middle East:	Asia:
Extron Electronics 1230 South Lewis Street Anaheim, CA 92805, USA	Extron Electronics, Europe Beeldschermweg 6C 3821 AH Amersfoort The Netherlands	Extron Electronics, Asia 135 Joo Seng Road, #04-10 PM Industrial Bldg. Singapore 368363

This Limited Warranty does not apply if the fault has been caused by misuse, improper handling care, electrical or mechanical abuse, abnormal operating conditions or non-Extron authorized modification to the product.

*If it has been determined that the product is defective, please call Extron and ask for an Applications Engineer at (714) 491-1500 (USA), 31.33.453.4040 (Europe), or 65.383.4400 (Asia) to receive an RA# (Return Authorization number). This will begin the repair process as quickly as possible.*

Units must be returned insured, with shipping charges prepaid. If not insured, you assume the risk of loss or damage during shipment. Returned units must include the serial number and a description of the problem, as well as the name of the person to contact in case there are any questions.

Extron Electronics makes no further warranties either expressed or implied with respect to the product and its quality, performance, merchantability, or fitness for any particular use. In no event will Extron Electronics be liable for direct, indirect, or consequential damages resulting from any defect in this product even if Extron Electronics has been advised of such damage.

Please note that laws vary from state to state and country to country, and that some provisions of this warranty may not apply to you.

# Table of Contents

---

<b>Chapter 1 • Introduction</b> .....	1-1
<b>About this Manual</b> .....	1-2
<b>About the RGB 500 Series Interfaces</b> .....	1-2
<b>Features</b> .....	1-2
RGB 500 Series features .....	1-2
RGB 500, RGB 500 Dual, and RGB 508 feature .....	1-3
RGB 500 Dual and RGB 560 Dual feature .....	1-3
RGB 508 and RGB 560 feature .....	1-3
RGB 560, RGB 560 Dual, and RGB 568 features .....	1-3
<b>Chapter 2 • Installation and Operation</b> .....	2-1
<b>Installing the RGB 500 Series Interfaces</b> .....	2-2
<b>Installation and Setup Overview</b> .....	2-2
<b>Installation and Operation Instructions</b> .....	2-3
Determining installation location .....	2-3
Preparing the installation site .....	2-3
Installing the mounting bracket with clips .....	2-4
Installing the mounting bracket with screws .....	2-4
Setting bottom and top panel switches .....	2-5
Bottom panel features .....	2-6
Top panel jumper switches .....	2-9
Attaching audio output, power & video output cables .....	2-10
Attaching adapter plates .....	2-10
Setting front panel switches .....	2-12
Front panel features — RGB 500 series, RGB 508 series .....	2-12
Front panel features — RGB 560 series, RGB 568 series .....	2-13
Connecting input cables .....	2-15
Pre-installation testing/troubleshooting .....	2-16
Mounting the interface to the mounting bracket .....	2-17
Attaching the faceplate .....	2-18
<b>Appendix A • Specifications</b> .....	A-1
<b>Appendix B • Rough-in Templates</b> .....	B-1
<b>Appendix C • Dimensions</b> .....	C-1
<b>RGB 500 and RGB 560 Faceplates</b> .....	C-2
<b>RGB 500 Dual and RGB 560 Dual Faceplates</b> .....	C-3

*(Continued)*

## Table of Contents, cont'd

---

RGB 508 and RGB 568 Faceplates .....	C-4
<b>Appendix D • Accessories and Part Numbers</b> .....	D-1
<b>Interfaces</b> .....	D-2
<b>Power Supply</b> .....	D-3
<b>Optional Adapter Plates</b> .....	D-3
Single Type Connector Architectural Adapter Plates .....	D-4
Multi Type Connector Architectural Adapter Plates .....	D-6
<b>Cables</b> .....	D-7
<b>Other Accessories</b> .....	D-9

*All trademarks mentioned in this manual are the properties of their respective owners.*



## RGB 500 Series

# Chapter One

## Introduction

About this Manual

About the RGB 500 Series Interfaces

Features

68-455-02 A  
Printed in the USA  
04 01

## About this Manual

This manual contains information about the Extron RGB 500 architectural series universal interfaces (RGB 500, RGB 500 Dual, RGB 508, RGB 560, RGB 560 Dual, and RGB 568) and on how to operate and configure them.

## About the RGB 500 Series Interfaces

The RGB 500 Series interfaces are universal, analog, computer-video interfaces with 300 MHz (-3dB) video bandwidth. The series features Extron's ADSP™ (Advanced Digital Sync Processing™) to ensure stable sync signal output, while allowing trouble-free centering control.

## Features

### RGB 500 Series features

All RGB 500 Series interfaces provide the following features:

**Wall and furniture mountability** — The RGB 500 Series interfaces can be easily installed in any wall or hard surface, such as a podium, desk, or tabletop, using few tools. Wall studs are not needed for installation.

**Digital sync processing** — Using regular sync processing to allow centering control (H-shift) can create problems with some digital display devices as a result of the sync delay. Extron's ADSP™ (Advanced Digital Sync Processing™) restores a stable sync signal, while allowing centering control. The RGB 500 Series interfaces also provide another option, DDSP™ (Digital Display Sync Processing™), to ensure proper displays without altering sync pulse timing or width. It may be selected via a bottom panel DIP switch.

**Horizontal shift control** — Adjust horizontal centering via a front panel knob.

**RGBHV, RGBS or RGSB outputs** — Select the output format via bottom panel DIP switches.

**Serration pulse switch** — This DIP switch-selectable feature adds or strips the serration pulses from the signal to make it compatible with digital display devices. Use the serration pulse switch if flagging or bending occurs at the top of the video display.

**Gain/peaking adjustment** — Output gain and peaking levels may be adjusted individually for red, green and blue channels by using jumpers that are accessible through the top of the enclosure.

**Sync polarity adjustment** — Horizontal and vertical sync output can either follow input sync polarity, or outgoing sync can be forced to negative via jumper settings.

**Vertical sync pulse width adjustment** — Vertical sync pulse width can be adjusted via jumper settings.

**Autopower** — When a signal is present at the video/sync input, the interface will power on, and the green LED on the front panel will light.

**Stereo audio** — All RGB 500 Series interfaces accept unbalanced stereo audio and output balanced or unbalanced stereo audio.

**Choice of colors** — The RGB 500 Series interfaces are available with a choice of gray, black or white faceplates to blend into a variety of installations.

### RGB 500, RGB 500 Dual, and RGB 508 feature

**Video input termination selection switch** — A front panel toggle switch provides a way to switch between high Z and 75 ohm video input termination on these models. Select the video termination impedance that provides the best picture. Set this switch to High Z if a local monitor is connected, a laptop breakout cable is used, or if the picture is too dark. Set this switch to 75 ohms if no local monitor is connected or if the picture is too bright or blooming (unterminated).

### RGB 500 Dual and RGB 560 Dual feature

**Two interfaces** — The Dual models feature two interfaces with one integrated faceplate.

### RGB 508 and RGB 568 feature

**Connector adapter plates** — The RGB 508 and RGB 568 offer the ability to attach up to four optional adapter plates for user-configurable pass-through connectors.

### RGB 560, RGB 560 Dual, and RGB 568 features

**Local monitor output connector** — A 15-pin HD female local monitor connector on the front panel simplifies connections to a local display without the need for monitor breakout cables.

**ID bit termination switch** — These models feature front panel DIP switches to make ID bit termination easy. Use this feature if no local monitor is connected.

**Local monitor pins** — These DIP switches are used for routing local monitor signals for Macintosh 13" monitors and all other Mac/VGA-type monitors.



# Chapter Two

## Installation and Operation

Installing the RGB 500 Series Interfaces

Installation and Setup Overview

Installation and Operation Instructions

## Installing the RGB 500 Series Interfaces

The Extron RGB 500 Series interfaces consist of a faceplate, an interface (or interfaces) in a metal enclosure, and wall mounting brackets. The RGB 508 and RGB 568 series interfaces may also include optional connector adapter plates. Installation hardware is included with each interface.

## Installation and Setup Overview

This is an overview of how to install the wall-mounted interfaces. These steps are covered in detail in this chapter.

To install and set up the RGB 500 Series interfaces for basic operation, follow these basic steps:

- 1 Determine the installation location.
- 2 Prepare the site for installation. Use the supplied template to mark the rough-in cutout, then cut out the wallboard or wood.
- 3 Install the mounting bracket.
- 4 Set the bottom panel DIP and jumper switches and top panel gain/peaking adjustment jumpers. These items will be inaccessible after installation.
- 5 Attach the audio output, video output and power cables to the interface.
- 6 Attach any optional adapter plates, and attach output cables to the back sides of the adapter plates.
- 7 Set the front panel video termination toggle switch (RGB 500 and RGB 508 series models) or the front panel DIP switches (RGB 560 and RGB 568 models).
- 8 Temporarily connect the computer video and audio input cables and (for RGB 560 and RGB 568 models) the local monitor output cable. Connect any cables whose signals will be routed through the optional adaptor pass-through plates.
- 9 Connect power cables to the input and output devices. Turn on the input and output devices.
- 10 The image should now display on screen. If it does not display, or if the picture displays incorrectly, double check and make adjustments to cables, DIP switches and jumpers as needed. See the "Pre-installation testing/troubleshooting" section in this chapter.

- 11 Temporarily disconnect the computer video and audio input cables and (for RGB 560 and RGB 568 models) the local monitor output cable from the front panel of the interface.
- 12 Mount the interface to the mounting bracket.
- 13 Attach the faceplate to the interface and mounting bracket.
- 14 Reconnect the computer video and audio input cables and the local monitor output cable (for RGB 560 and RGB 568 models) to the interface, and readjust horizontal centering as needed via the front panel knob.

## Installation and Operation Instructions

### Determining installation location

Select an installation site. The mounting bracket may be installed in a wall using backing clips or may be installed on a hard surface, such as a podium, desk, tabletop, or hardwood wall, using wood/metal screws. Take cabling and power availability into consideration.

The RGB 500 Series interfaces do not require attachment to wall studs, so they may be placed almost anywhere on a wall.

### Preparing the installation site

Actual size rough-in templates for each model are provided in Appendix B. Use them as guides to mark and cut the hole in the wall or furniture through which the interface will be installed. The innermost line represents the opening where material will be removed and the mounting bracket will be installed.

1. Cut out the center portion (up to the guidelines) of the rough-in template supplied with the mounting bracket.
2. Place the template on the wall or surface where the interface will be installed. Use a soft pencil to mark the guidelines for the opening on the wall.
3. Cut out the material from the rough-in area with a jigsaw or small hand saw.
4. Check the opening size by inserting the mounting bracket into the opening. The flat portion should lay snugly on the wall or surface, and the tabs through which the screws will be inserted should fit easily into the opening. There should not be noticeable play within the opening.
5. If needed, use a saw, file or sandpaper to enlarge the hole. Smooth the edges of the opening to avoid damage or

injury to yourself or the cables during installation.

### Installing the mounting bracket with clips

1. Place 1¼" (3.18 cm) long **or** ¾" (1.9 cm), #6-32 machine screws (provided) through the holes in each corner of the mounting bracket. Use the shortest screw required. Loosely fasten (using 2-3 turns) a mounting backing clip on the end of each screw.
2. Insert the mounting bracket into the opening in the wall.

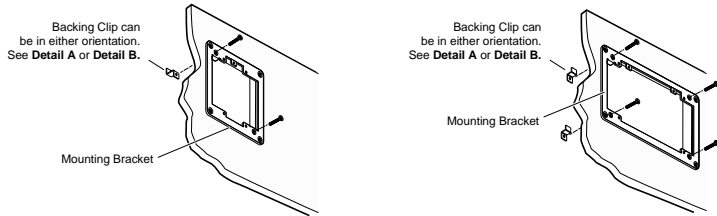

### Installing the mounting bracket with backing clips

3. Rotate each clip so the tab will be behind the plywood, wallboard/sheet rock or other surface to hold the bracket snugly in place when the screw is tightened. See Detail A and Detail B.

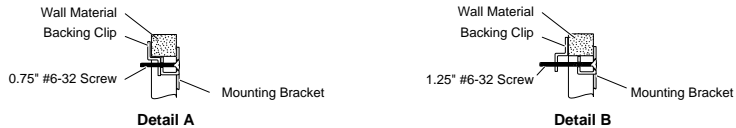

### Backing clip orientations

4. Use a Phillips screwdriver to hand tighten the screws to fasten the mounting bracket in place.

### Installing the mounting bracket with screws

Use this installation method if the installation surface is a sturdy, dense material such as sheet metal, plywood, or hard wood.

1. Insert the mounting bracket into the opening in the wall and hold it firmly in place.
2. Mark the locations of the outermost/corner bracket holes on the installation surface.
3. If desired, remove the mounting bracket and drill ¼" deep pilot holes (half the width of the shaft of the screw) at the marked locations.

4. Insert the bracket back into the hole.
5. Use four ½" (1.3 cm) long, #6 flat headed wood screws (provided) or self-tapping sheet metal screws to fasten the bracket directly onto wood or metal, respectively. Hand tighten the screws. See the illustration below.

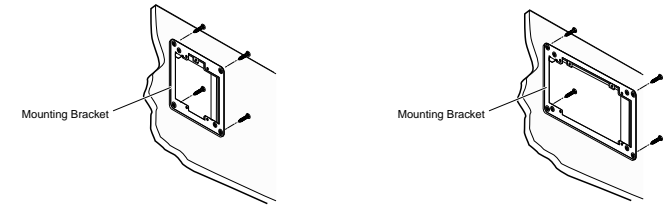

### Installing the mounting bracket with screws

### Setting bottom and top panel switches

Because the top and bottom panels on all models **will be inaccessible after installation**, the DIP and jumper switches must be set before the interface is installed into the wall, furniture or raceway. Use the switch explanations to help you configure these switches.

Set the DIP switches to either On (closed) or Off (open) to select the desired function as described in the features section.

The DIP switches may be either the rocking type or the sliding type.

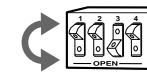

To set rocking-type DIP switches, use a small screwdriver to depress the appropriate end of the switch.

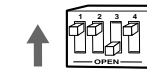

To set the sliding type of DIP switches, use a small screwdriver to slide (push) the switch to the desired position (On/closed or Off/open).

To configure jumper switches, use a needlenosed plier to reach through the openings in the enclosure and pull the jumper shunt out/off the pins, then place the jumper on the appropriate pins, as shown below.

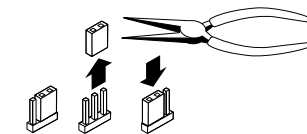

### Changing jumper settings



## Bottom panel features

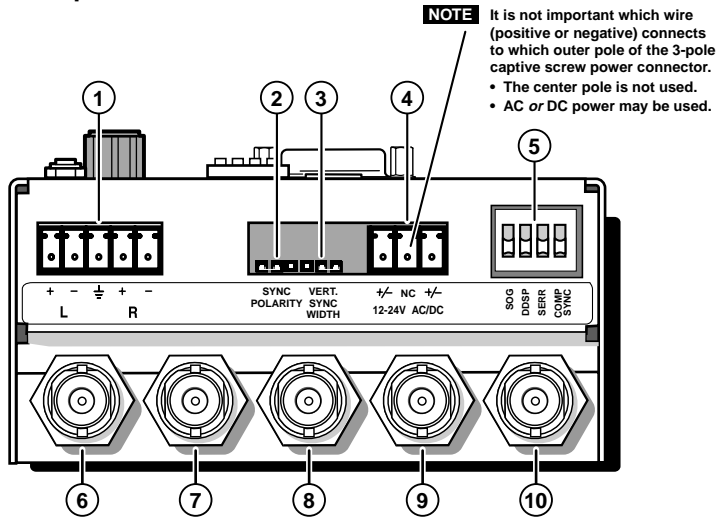

- ① **Audio output captive screw connector** — This 3.5 mm, 5-pole right angle captive screw (Phoenix) connector will be used for balanced/unbalanced audio output. Attach the five wires for audio output of ground, left and right channels to the connector; follow the wiring guide on the bottom panel label or the one shown below.

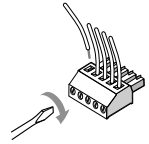

Insert the wires into the appropriate openings. Tighten the screws on top to fasten the wires.

**WARNING** Connect the sleeve to ground (GND). Connecting the sleeve to a negative (-) terminal will damage the audio output circuits.

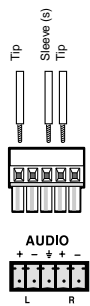

Unbalanced Output

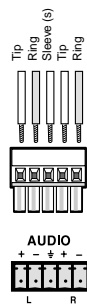

Balanced Output

### Wiring a captive screw connector for audio output

- ② **Sync polarity jumper switch** — This jumper switch adjusts the output sync polarity. Horizontal and vertical sync output can either follow input sync polarity, or be forced to negative. You will need needlenosed pliers to reach and move the jumper. See the diagram below.

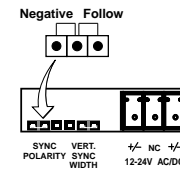

- If the jumper is placed on the two left pins, output sync polarity follows input sync polarity.
- If the jumper is placed on the two rightmost pins, output H and V sync polarities will be forced to negative.

- ③ **Vertical sync width jumper switch** — This jumper switch adjusts the vertical sync pulse width. For some digital display devices, if no picture displays, the picture cuts in and out, or the picture is scrambled, try adjusting the vertical sync pulse width or switching from ADSP to DDSP.

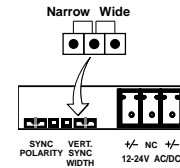

You will need needlenosed pliers to reach and move the jumper. See the diagram below.

- If the jumper is placed on the two leftmost pins, the output vertical sync pulse will be narrow.
- If the jumper is placed on the two right pins, the output vertical sync pulse will be wide.

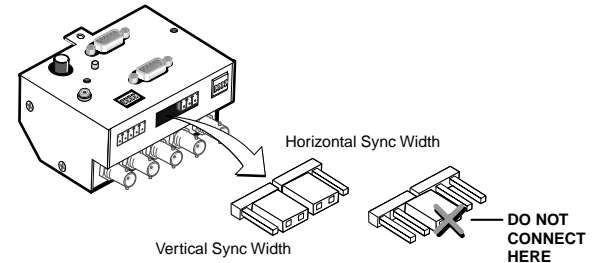

### Changing the sync jumper switches

- ④ **Captive screw power connector** — Use this 3-pole, 3.5 mm captive screw power connector with a 12 to 24VDC or 12 to 24VAC, 0.35A, external, autoswitchable power supply, such as Extron's #70-055-01.

**NOTE** The center pole contains no conductor. Connect conductors to the outer two poles only.

**NOTE** *Polarity is not important: the positive or negative wire may be connected to either of the outer poles.*

- ⑤ **Bottom panel DIP switches** — These four DIP switches, numbered 1 to 4 from left to right, control the sync on green, serration pulse, DDSP and composite sync output options.

### 1 — SOG (sync on green)

ON — When this switch is set to On, (sync on green), the interface will output sync on green.

OFF — When the SOG feature is set to Off, the interface will output either separate horizontal and vertical sync signals (on the H/HV and V connectors) or a composite sync signal (on the H/HV connector), depending on how DIP switch 4 is set.

### 2 — DDSP™ (Digital Display Sync Processing™)

ON — When this switch is set to On, the interface uses Digital Display Sync Processing instead of Advanced Digital Sync Processing™. Use this option if the image still doesn't display properly after other options (changes to sync width, serration pulses and video termination) have been explored.

**NOTE** *DDSP will disable horizontal shift control.*

OFF — When this switch is set to Off, the interface uses ADSP™, Advanced Digital Sync Processing™.

### 3 — SERR (serration pulse)

Many display devices, including LCD and DLP projectors and plasma displays, must not have serration pulses in the vertical sync signal in order to display properly. Flagging or bending at the top of the video image is a sign that the serration pulses should be removed.

ON — When this switch is set to On, serration pulses will be output.

OFF — When this switch is set to Off, serration pulses will not be output.

### 4 — Composite sync

ON — When this switch is set to On, a composite sync signal (H and V combined) will be output on the connector labeled "H/HV".

OFF — When this switch is set to Off, horizontal sync will be output on the connector labeled "H/HV", and vertical sync will be output on the "V" connector.

- ⑥ **Blue (B) output connector** — BNC female connector for blue video output.
- ⑦ **Green (G) output connector** — BNC female connector for green video output.
- ⑧ **Red (R) output connector** — BNC female connector for red video output.
- ⑨ **Horizontal (H) or composite sync (HV) output connector (H/HV)** — BNC female connector for either separate horizontal sync or composite sync output.
- ⑩ **Vertical (V) sync output connector** — BNC female connector for separate vertical sync output.

### Top panel jumper switches

Video signals passing through long cable runs (over 125 feet) can decrease in strength, creating signal loss. The longer the cable, the higher the video level and the greater the peaking that will be needed to compensate for the loss.

The red, green and blue gain/peaking adjustment jumper switches are located on the top of the RGB 500 Series interfaces. You will need needlenosed pliers to reach and move the jumpers. Select the setting that yields the best image display.

Use the diagram on the product label, shown in the illustration, as a guide to setting the output gain/peaking for each color.

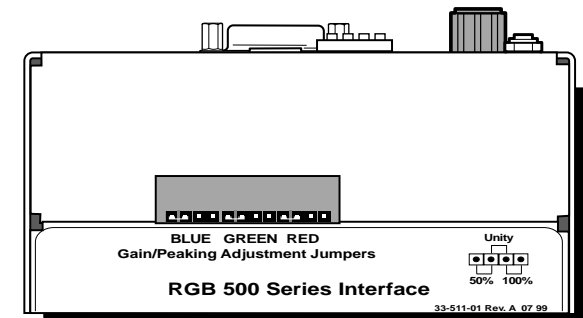

**Top view of an RGB 500 Series interface**

- Use the left two pins to increase the output signal and add 50% of the maximum peaking to the signal.
- Use the middle two pins for unity output (0.7 volts, no peaking).

## Installation and Operation, cont'd

- Use the right two pins to increase the output signal and add 100% of the maximum peaking to the signal for very long cable runs.

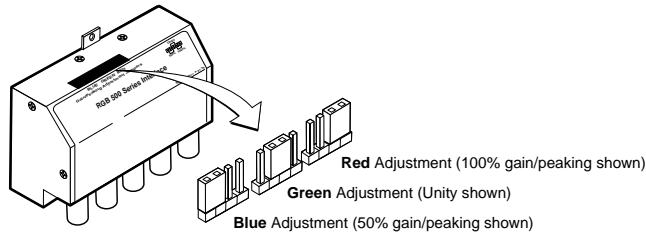

### Attaching audio output, power, and video output cables

Once the switches have been set, attach the cables that will be inaccessible after installation. These cables should already be installed in the wall, conduit or furniture. See pages 2-7 and 2-10 for details

1. Plug the wired audio connector into the audio output female connector on the bottom of the interface.
2. Attach the video and sync output cables to the interface with BNC connectors. Pay close attention to the order and location of connectors.

**NOTE** *The connectors on the RGB 500 Series interfaces are arranged in the following order on the bottom of the enclosure: **B, G, R, H/HV, and V.***

3. Attach the 12VDC to 24VDC power supply to the interface via the 3-pole captive screw terminal on the bottom panel. See pages 2-7 and 2-9 for details. Plug in or connect the power supply to the AC power outlet. The interface's front panel power indicator LED will light.

### Attaching adapter plates

The RGB 508 and RGB 568 can have up to 4 optional adapter plates.

The adapter plates must be ordered separately. They also must be attached to the faceplate and cabled before the interface is installed in the wall or furniture. The screws needed for installing the adapter plates are built into the plates, so no additional screws will be needed.

1. Insert the adapter plate screws through the holes in the faceplate. Attach the adapter plates to the faceplate with the provided captive washers and #4-40 nuts.

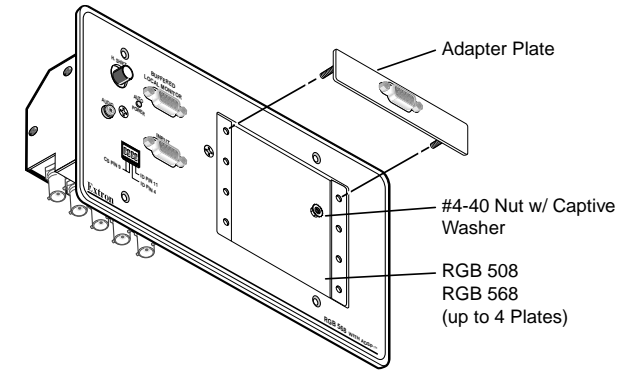

### Installing optional adapter plates

2. Attach the output cables to the back side of the adapter plate(s). Several adapter plates require conductors to be soldered to the connectors. Attach foil and braided shields to ground connections.

## Setting front panel switches

Set the front panel switches before cabling and testing inputs. These examples will show 2-gang size interfaces, but they apply to both 2- and 4-gang sizes and to the EC models.

### Front panel features — RGB 500 series, RGB 508 series

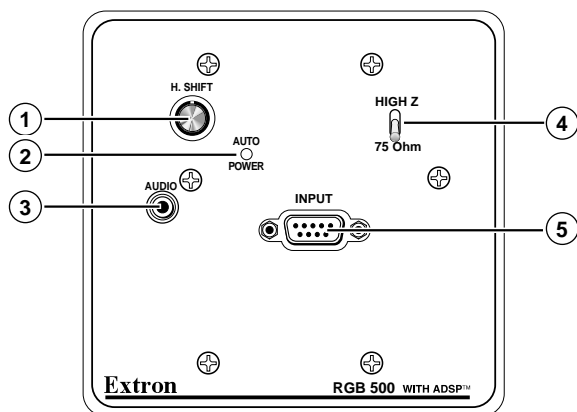

- ① **Horizontal shift knob** — Use this knob to adjust the horizontal sync to move the picture left or right to center it each time the interface is powered on.

**NOTE** *The horizontal shift control has no mechanical limits to rotation. When the minimum or maximum limit of the control is reached, the picture ceases to move on screen.*

- ② **Power indicator LED** — The RGB 500 Series interfaces have a built-in autpower feature. When a signal is present at the input, the interface will power on, and the green front panel LED will light.

- ③ **Audio input connector** — Use this 3.5 mm stereo jack to connect an unbalanced audio source to the interface. Wire the plug as shown at left.

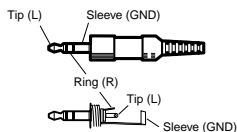

- ④ **Video input termination toggle switch** — The toggle switch on the front panel allows you to select video input impedance that provides the best picture.

- Set this switch to High Z if a local monitor is connected, a laptop breakout cable is used, or if the picture is too dark.

- Set this switch to 75 ohms if no local monitor is connected or if the picture is too bright or blooming (unterminated).

- ⑤ **Computer video input 9-pin D male connector**

### Front panel features — RGB 560 series, RGB 568 series

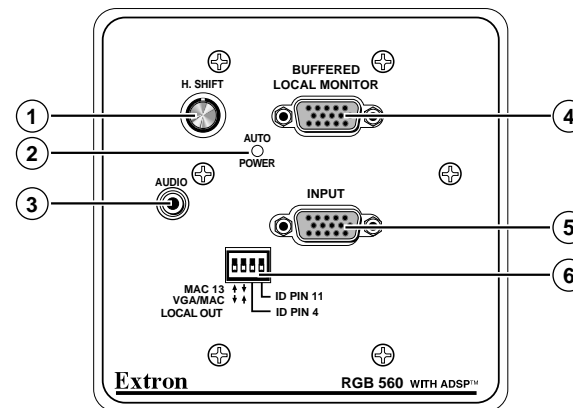

- ① **Horizontal shift knob** — Use this knob to adjust the horizontal sync to move the picture left or right to center it each time the interface is powered on.

**NOTE** *The horizontal shift control has no mechanical limits to rotation. When the minimum or maximum limit of the control is reached, the picture ceases to move on screen.*

**NOTE** *DDSP will disable horizontal shift control.*

- ② **Power indicator LED** — The RGB 500 Series interfaces have a built-in autpower feature. When a signal is present at the input, the interface will power on, and the green front panel LED lights.

- ③ **Audio input connector** — Use this 3.5 mm stereo jack to connect an unbalanced audio source to the inter-face. See page 2-13 for a diagram for wiring the plug.

- ④ **Buffered local monitor output 15-pin HD female connector**

- ⑤ **Computer video input 15-pin HD female connector**

- ⑥ **Front panel DIP switches** — The RGB 560, RGB 560 Dual, and RGB 568 have a bank of DIP switches on the front panel for controlling the following functions:

**1 & 2 — Local monitor pins** — These are used for routing local monitor signals for Macintosh 13" monitors and all other Mac/VGA-type monitors.

**1 = ON and**

**2 = OFF** — For Macintosh 13" monitors, set DIP switch 1 to On and 2 to Off for proper sync routing for the 15-pin HD local monitor output. This is used with Extron Macintosh cable adapter kits #70-078-01 and #70-078-02, which include audio connections.

**1 = OFF and**

**2 = ON** — For all other Macintosh and VGA-type computers, set DIP switch 1 to Off and 2 to On to pass the signal from input pin 9 through to pin 9 of the local monitor output.

**1 = ON and 2 = ON** or

**1 = OFF and 2 = OFF** — These settings are not valid combinations. They will not work with either computer type.

**3 — ID PIN 4 (pin 4 local monitor ID bit termination)**

**4 — ID PIN 11 (pin 11 local monitor ID bit termination)** — Use DIP switches 3 and 4 to provide proper ID bit termination when a local monitor is not connected to the interface's buffered local monitor output.

DIP switch 3 connects pin 4 to ground.

DIP switch 4 connects pin 11 to ground.

**ON** — Set both switches (ID PIN 4 and ID PIN 11) to On if no local monitor is connected. Pins 4 and 11 will be grounded for ID bit termination at the 15-pin HD local monitor output.

**OFF** — Set both switches to Off if a local monitor will be attached to the interface. No monitor ID bit will be set.

## Connecting input cables

At this point the input cables should be connected so that the display can be tested and any necessary changes to switch settings can be made before the interface is installed into the wall or furniture.

Connect the input cables temporarily for testing, then disconnect them later so the interface can be installed in the wallplate and the faceplate attached to the interface. Input cables can be reconnected after the interface and faceplate are attached to the installation surface.

1. For all models, connect the computer video input cable(s), audio input cable(s), and (for RGB 560 and RGB 568 models) the local monitor output cable(s).

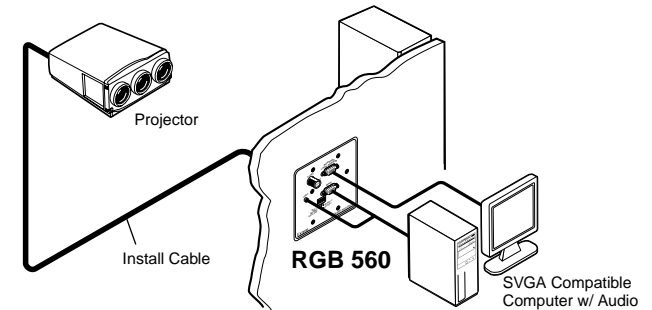

### A typical RGB 560 application

2. Connect any input cables whose signals will be routed through the optional adaptor pass-through plates.

### Pre-installation testing/troubleshooting

Before completing the installation, test the system to make sure that the connections and interface settings are correct.

1. Turn on the input device(s) (computer) and output device(s) (projector and/or monitor). The image should now display on the screen.
2. If the image is not displayed at all, double-check cable connections, and ensure that all devices have power and are turned on. For the RGB 500 series and RGB 508 series, try changing the video termination toggle switch setting. For the RGB 560 series and RGB 568 series, if no local monitor is present, change the ID bit termination via the front panel DIP switch, then reboot the computer.
3. If the image appears, but it looks scrambled or cuts in and out, check the bottom and front panel DIP switch and jumper settings. If all switches are already set to what should be the correct settings for the connected input and output devices, try different settings.

If the display device is digital (including LCD, DLP, and plasma devices), try changing the vertical sync pulse width (using the bottom panel jumper).

Next try changing the sync options (sync on green, composite sync), sync polarity, or serration pulse options, or switch from ADSP to DDSP. You may need to use a combination of settings to achieve a proper display.

4. If the image appears and is stable, but it appears faint or fuzzy, increase the output gain/peaking by changing the top panel jumpers. If the image is too bright, decrease the gain/peaking level.
5. If the image displays and is stable, but it has a greenish tint, it may be a result of using video input with sync on green. Incoming sync on green will not be stripped from the green signal by the interface.
6. If the image appears and is stable, but it has ghosting or blooming, change the video input termination. If changing the termination doesn't solve the problem, try using a different input cable.
7. For further assistance, call the Extron S<sup>3</sup> Sales & Technical Support Hotline.
8. Once the image displays correctly on screen, you may adjust the horizontal centering using the front panel knob, though this adjustment must be made each time the interface is turned on.

### Mounting the interface to the mounting bracket

1. Temporarily disconnect the computer video and audio input cables and (for the RGB 560 series and RGB 568 series) the local monitor output cable from the front panel of the interface.
2. For all models, attach the interface to the mounting bracket with one 3/8" (0.95 cm) long #4-40 machine screw (provided) inserted through the tab at the top of the enclosure, as shown below.

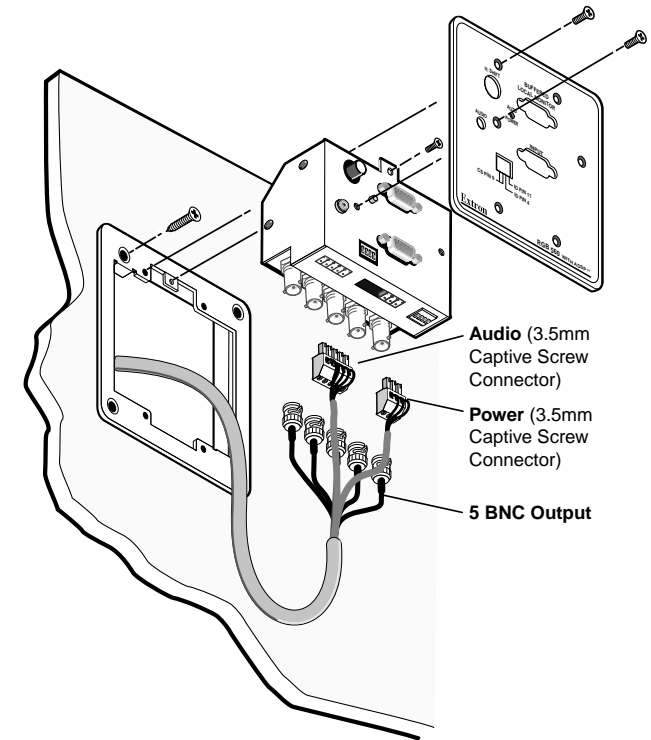

### Attaching the interface to the mounting bracket and the faceplate to the interface

3. Follow the directions in the next section for attaching the faceplate.



### Attaching the faceplate

1. Attach the faceplate to the interface(s) using two 3/8" (0.95 cm) long #4-40 machine screws (provided) per two-gang size (four screws total for the RGB 500 Dual, RGB 508, RGB 560 Dual and RGB 568). Use the illustration on the opposite page as a guide.
2. Insert the interface and attached cables into the opening in the wall or furniture, taking care not to damage the cables.
3. Attach the faceplate to the mounting bracket with four 3/8" (0.95 cm) long, #6-32 machine screws (provided). Use the illustration on the opposite page as a guide.
4. Reconnect the computer video and audio input cables and (for the RGB 560 series and RGB 568 series) the local monitor output cable to the interface.
5. Adjust horizontal centering as needed.

# Appendix A

## Specifications

Interface Specifications

# Specifications

## Video

Gain .....	Unity (0.70V p-p), (0.725V p-p) 50% peaking, (0.75V p-p) 100% peaking
Bandwidth .....	300 MHz (-3dB)

## Video input

Number/signal type .....	1 analog RGBHV, RGBS, RGSB, RsGsBs
Connectors	
<b>RGB 500, RGB 500 Dual, RGB 508, RGB 500 AKM</b>	1 9-pin D male, MBC/LBC cable or buffer
<b>RGB 560, RGB 560 Dual, RGB 568, RGB 560 AKM</b>	1 15-pin HD female
Minimum/maximum levels .....	Analog ..... 0.3V to 1.5V p-p with no offset
Impedance .....	75 ohms or High Z, switchable (set to 75 ohms if no local monitor is connected)
Horizontal frequency .....	Autoscan 15 kHz to 130 kHz
Vertical frequency .....	Autoscan 30 Hz to 120 Hz
Return loss .....	-30dB @ 5 MHz
Maximum DC offset .....	4.0V

## Video output

Number/signal type .....	1 analog RGBHV, RGBS, RGSB
Connectors	
<b>All models</b> .....	5 BNC female
<b>RGB 560, RGB 560 Dual, RGB 568, RGB 560 AKM</b>	1 15-pin HD female for buffered local monitor output
Minimum/maximum levels .....	0.70V to 0.75V p-p with no offset and 0.7V p-p input
Impedance .....	75 ohms
Return loss .....	-30dB @ 5 MHz

## Sync

Input type .....	RGBHV TTL ( $\pm$ ), RGBS TTL (-), RGSB 0.3V (-), RsGsBs 1.3V (-)
Output type .....	RGBHV ( $\pm$ ), RGBS(-), RGSB (-)
Input level .....	2V to 5.5V p-p with $\pm 0.3$ VDC offset (max.)
Output level .....	4V to 5V p-p
Input impedance .....	10 kohms
Output impedance .....	75 ohms
Max. input voltage .....	5.7V p-p
Max. propagation delay .....	48 nS

Max. rise/fall time ..... 3.5 nS

## Polarity

<b>AKM models</b> .....	RGBHV .....	Polarity follows input when RGBHV is input and the sync polarity switch is set to Off. Sync polarity is negative if the sync polarity switch is set to On.
	RGBS, RGSB .....	Negative
<b>All other models</b> .....	RGBHV .....	Polarity follows input when RGBHV is input and the bottom panel sync polarity jumper is set to follow (pin 1 jumpered to pin 2). Sync polarity is negative if the sync polarity jumper is set to negative (pin 2 jumpered to pin 3).
	RGBS, RGSB .....	Negative

## Audio

Gain .....	Unbalanced 0dB, balanced +6dB
Frequency response .....	20 Hz to 20 kHz, $\pm 0.05$ dB
THD + Noise .....	0.03% @1 kHz, 0.3% @ 20 kHz at rated maximum output drive
S/N .....	>90dB at rated maximum output (14dBm), balanced
Stereo channel separation .....	>95dB @ 1 kHz to 20 kHz

## Audio input

Number/signal type .....	1 PC level stereo, unbalanced
Connectors .....	1 3.5 mm stereo jack, 2 channel; tip (L), ring (R), sleeve (ground)
Impedance .....	10 kohms, DC coupled
Maximum level .....	+8.5dBu, (unbalanced) at stated %THD+N

## Audio output

Number/signal type .....	1 stereo (2 channel), balanced/unbalanced
Connectors .....	1 3.5 mm stereo captive screw connector, 5 pole, for left and right output



## Specifications, cont'd

Impedance .....	50 ohms unbalanced, 100 ohms balanced
Gain error .....	±0.1dB channel to channel
Maximum level (600 ohm) .....	> +14dBm, balanced at stated %THD+N

### General

Power .....	12 to 24VAC or VDC, 0.35 A, 5 watts, external (Order the power supply separately, part #70-055-01.)
Temperature/humidity .....	Storage -40° to +158°F (-40° to +70°C) / 10% to 90%, non-condensing Operating +32° to +122°F (0° to +50°C) / 10% to 90%, non-condensing
Rack mount .....	No
Furniture mount .....	Yes, or wall mount, with included hardware
Enclosure type .....	Metal
Enclosure dimensions — <b>RGB 500, RGB 560</b>	
Faceplate .....	4.5" H x 4.6" W (11.4 cm H x 11.7 cm W)
Interface enclosure .....	2.5" H x 3.7" W x 1.75" D (6.4 cm H x 9.4 cm W x 4.5 cm D) (Depth excludes connectors and knobs.)
Enclosure dimensions — <b>RGB 500 Dual, RGB 508, RGB 560 Dual, RGB 568</b>	
Faceplate .....	4.5" H x 8.2" W (11.4 cm H x 20.8 cm W)
Interface enclosure .....	2.5" H x 3.7" W x 1.75" D (6.4 cm H x 9.4 cm W x 4.5 cm D) (Depth excludes connectors and knobs.)
Enclosure dimensions — <b>RGB 500 AKM, RGB 560 AKM</b>	
Interface .....	3.1" H x 8.1" W x 1.6" D (7.8 cm H x 20.6 cm W x 4.1 cm D) (Depth excludes connectors and knobs.)
Shipping weight .....	RGB 500, RGB 560 .... 2 lbs (0.9 kg) All other models ..... 3 lbs (1.4 kg)
Vibration .....	ISTA/NSTA 1A in carton (International Safe Transit Association)
Approvals .....	<b>AKM models</b> ..... UL, CE <b>All other models</b> ..... UL, CE, FCC Class A
MTBF .....	30,000 hours
Warranty .....	2 years parts and labor

**NOTE** Specifications are subject to change without notice.



## RGB 500 Series

# B

## Appendix B

### Rough-in Templates

RGB 500 and RGB 560 Rough-in Template

RGB 500 Dual, RGB 508, RGB 560 Dual and  
RGB 568 Rough-in Template

## Rough-in Templates

### RGB 500 and RGB 560 Rough-in Template

Use this template as a guide for cutting the hole in the installation surface (wall or furniture). This diagram is for the interfaces with 2-gang size faceplates. It is shown at actual size.

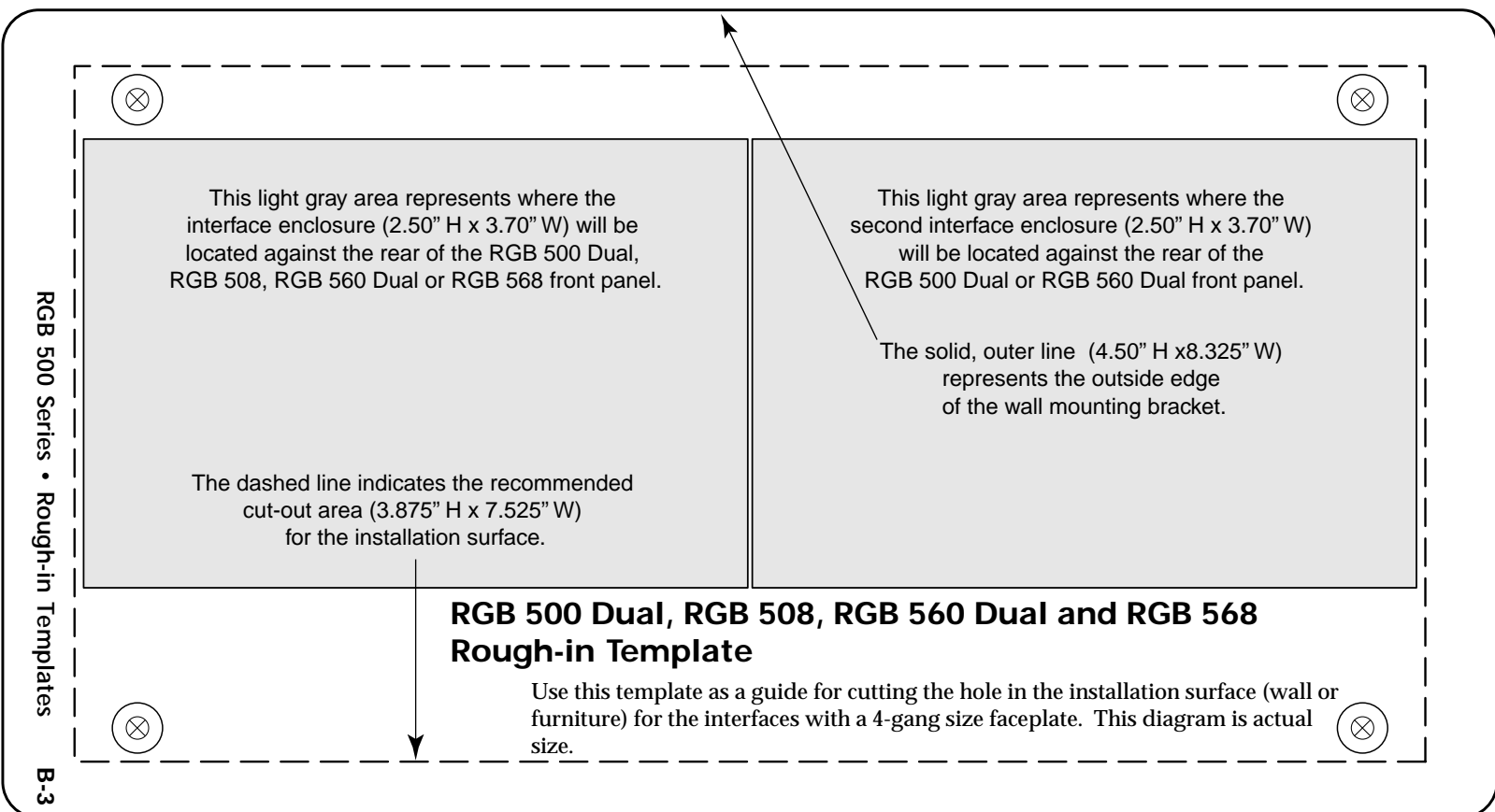
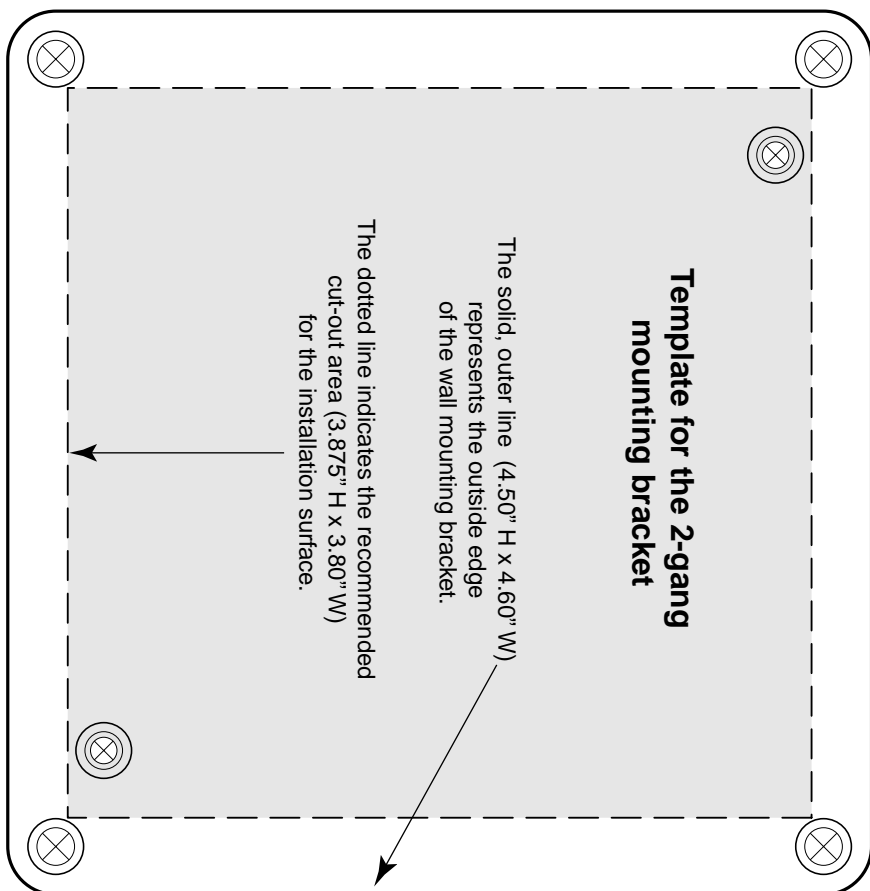



# Appendix C

## **Dimensions**

RGB 500 and RGB 560 Faceplates

RGB 500 Dual and RGB 560 Dual Faceplates

RGB 508 and RGB 568 Faceplates

# Dimensions

Dimensions of the RGB 500 Series faceplates are provided here for those who wish to make their own customized faceplates. The diagrams are shown at 70% of actual size.

**NOTE** All dimensions are given in inches.

## RGB 500 and RGB 560 Faceplates

### RGB 500 faceplate dimensions

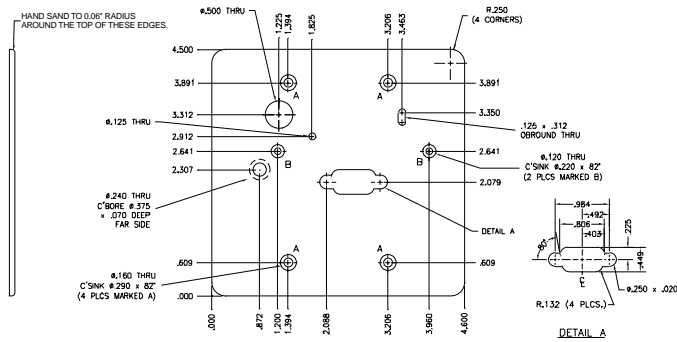

### RGB 560 faceplate dimensions

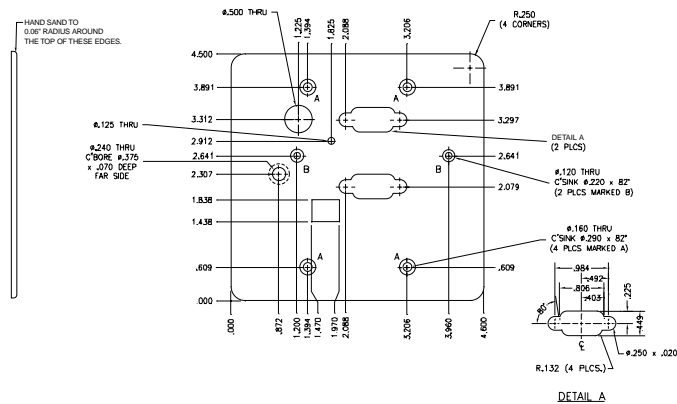

## RGB 500 Dual and RGB 560 Dual Faceplates

### RGB 500 Dual faceplate dimensions

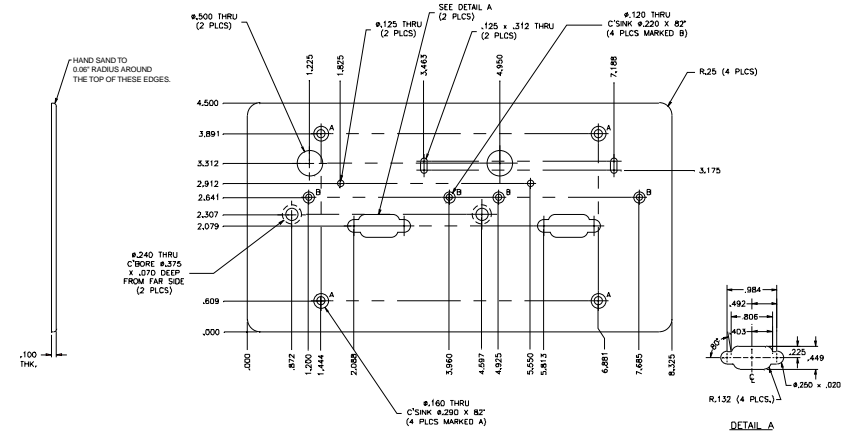

### RGB 560 Dual faceplate dimensions

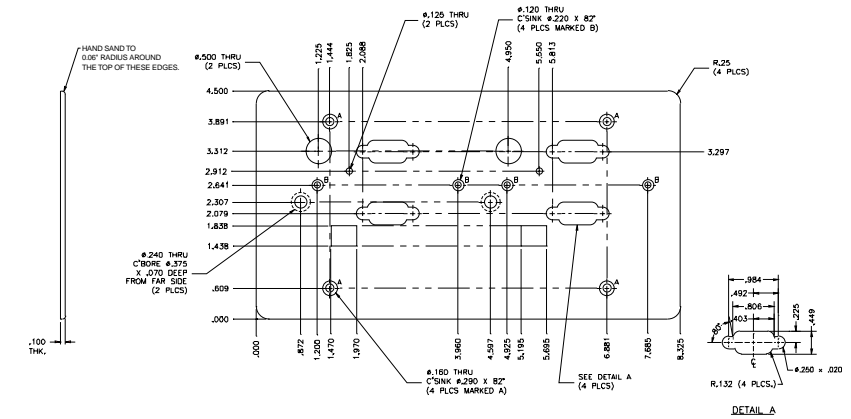

RGB 508 and RGB 568 Faceplates



RGB 500 Series

RGB 508 faceplate dimensions

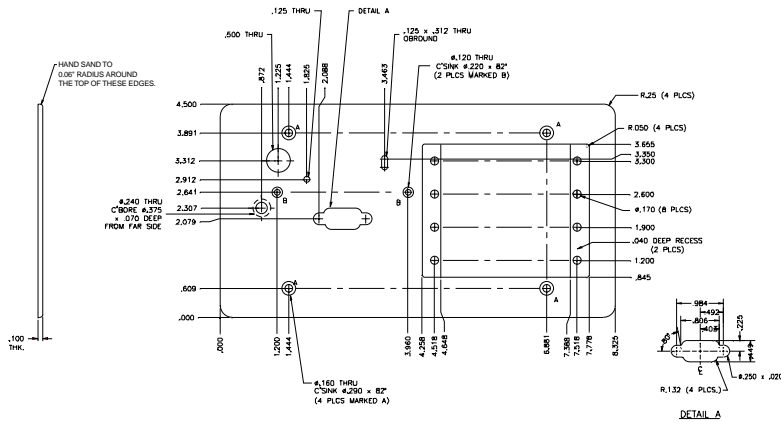

RGB 568 faceplate dimensions

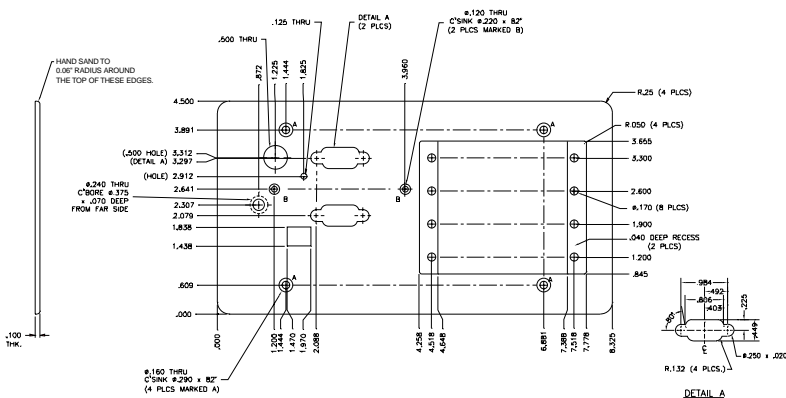

# D

## Appendix D

### Accessories and Part Numbers

- Interfaces
- Power Supply
- Optional Adapter Plates
- Cables
- Other Accessories

## Interfaces

Series	Product Name	Part Number
RGB 500	RGB 500 Gray	60-286-01
	RGB 500 Black	60-286-02
	RGB 500 White	60-286-03
	RGB 500 Dual Gray	60-286-11
	RGB 500 Dual Black	60-286-12
	RGB 500 Dual White	60-286-13
RGB 508	RGB 508 Gray	60-287-01
	RGB 508 Black	60-287-02
	RGB 508 White	60-287-03
RGB 560	RGB 560 Gray	60-381-01
	RGB 560 Black	60-381-02
	RGB 560 White	60-381-03
	RGB 560 Dual Gray	60-382-11
	RGB 560 Dual Black	60-382-12
	RGB 560 Dual White	60-382-13
RGB 568	RGB 568 Gray	60-383-01
	RGB 568 Black	60-383-02
	RGB 568 White	60-383-03

## Power Supply

The RGB 500 Series interfaces require an external power supply with the following specifications:

12 to 24 volts AC or DC, 0.5 A, with a right angle 3.5 mm captive screw connector (3-pole) for connection to the interface.

Extron's power supply (part #70-055-01) is ideal for this application, and it comes with the appropriate connector installed. If you use another power supply, 3-pole right angle captive screw connectors (part #10-436-11) are available.

## Optional Adapter Plates

A variety of optional adapter plates for pass-through connections may be ordered for the RGB 508 series and RGB 568 series interfaces.

The RGB 508 and RGB 568 can have up to 4 adapter plates installed.

The following configurations of adapters could be installed in an RGB 508 or RGB 568:

- four adapter plates with a "plate size" of one,
- two adapter plates with a plate size of one and one adapter plate with a plate size of two,
- or two adapter plates of plate size two.

The tables on the following pages list the available adapter plates.

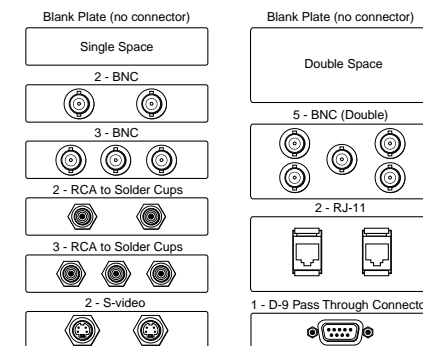

**Architectural adapter plates**

### Single Type Connector Architectural Adapter Plates

Adapter plate description	Plate size	Front connector type	Rear connector type	Part #	Gray	Black	White
Blank plate 1	1	n.a.	n.a.	70-090	-01	-11	-21
Blank plate 2	2	n.a.	n.a.	70-090	-02	-12	-22
2 BNC barrel (female to female)	1	BNC female	BNC female	70-091	-01	-11	-21
3 BNC barrel (female to female)	1	BNC female	BNC female	70-091	-02	-12	-22
5 BNC barrel (female to female)	2	BNC female	BNC female	70-091	-03	-13	-23
2 RCA female to solder cups	1	RCA female (red/black)	solder lug terminals	70-092	-01	-11	-21
3 RCA female to solder cups	1	RCA female (red/black)	solder lug terminals	70-092	-02	-12	-22
2 RCA female barrel (female to female)	1	RCA female (red/black)	RCA female	70-093	-01	-11	-21
3 RCA female barrel (female to female)	1	RCA female (red/black)	RCA female	70-093	-02	-12	-22
2 RCA to BNC barrel (female to female)	1	RCA female (red/black)	BNC female	70-094	-01	-11	-21
3 RCA to BNC barrel (female to female)	1	RCA female (red/black)	BNC female	70-094	-02	-12	-22
2 S-video to S-video barrel (female to female)	1	4-pin mini DIN female	4-pin mini DIN female	70-095	-01	-11	-21

2 F connector barrel	1	F connector female	F connector female	70-096	-01	-11	-21
2 ¼" stereo phono female	1	¼" stereo phono female	3 solder lug terminals	70-097	-01	-11	-21
2 ¼" mono phono female	1	¼" mono phono female	2 solder lug terminals	70-097	-02	-12	-22
2 3.5mm mini stereo female	1	3.5mm mini stereo female	3 solder lug terminals	70-098	-01	-11	-21
2 RJ-11 (female to female)	2	RJ-11 female	RJ-11 female	70-099	-01	-11	-21
2 RJ-45 (female to female)	2	RJ-45 female	RJ-45 female	70-100	-01	-11	-21
1 HD-15 (female to female)	1	15-pin HD female	15-pin HD female	70-101	-01	-11	-21
1 HD-15 (male to male)	1	15-pin HD male	15-pin HD male	70-101	-02	-12	-22
1 D-9 (female to female)	1	9-pin D female	9-pin D female	70-102	-01	-11	-21
1 D-9 (male to male)	1	9-pin D male	9-pin D male	70-102	-02	-12	-22
1 3-pin XLR female	2	3-pin XLR female	3 solder lug terminals	70-103	-01	-11	-21
1 4-pin XLR female	2	4-pin XLR female	3 solder lug terminals	70-103	-02	-12	-22
1 6-pin XLR female	2	6-pin XLR female	3 solder lug terminals	70-103	-03	-13	-23
2 6-pin mini DIN (keyboard/mouse)	1	6-pin mini DIN female	6-pin mini DIN female	70-104	-01	-11	-21
1 3.5mm, 5 pole captive screw terminal	1	3.5mm, 5 pole captive screw terminal	solder cups	70-105	-01	-11	-21
1 contact closure switch/LED show-me and 3.5mm stereo mini jack	1	contact closure switch and 3.5mm mini stereo jack	solder cups	70-106	-01	-11	-21

Multi Type Connector Architectural Adapter Plates						
Adapter plate description	Plate size	Front connector type	Rear connector type	Part #	Gray	Black
1 S-video female and 1 BNC female	1	4-pin mini DIN female and BNC female	4-pin mini DIN female and BNC female	70-107	-01	-02
1 S-video female and 3 RCA female	2	4-pin mini DIN female and RCA female	4-pin mini DIN female and RCA female	70-107	-02	-12
1 S-video female and 2 RCA female	1	4-pin mini DIN female and RCA female	4-pin mini DIN female and RCA female	70-107	-03	-23
1 BNC female and 2 RCA female	1	BNC female and RCA female	BNC female and RCA female	70-108	-01	-21
1 BNC female and 1 3.5mm mini stereo jack	1	BNC female and 3.5mm mini stereo jack	BNC female and 3 solder cups	70-108	-02	-22
1 RCA female and 1 3.5mm mini stereo jack	1	RCA female and 3.5mm mini stereo jack	RCA female and 3 solder cups	70-109	-01	-03

**Cables**

Male-to-male VGA cables (for RGB 560)	Part number
VGA M6' MHR	26-238-01
VGA M3' MHRA (with audio)	26-490-01
VGA M6' MHRA (with audio)	26-490-02
VGA M12' MHRA (with audio)	26-490-03

Male-to-male 90° VGA cables (for RGB 560)	Part number
VGAM 90 MHRA 6' (with audio)	26-510-02

Monitor breakout cables (RGB 500)	Part number
MBC VGA/XGA HR	26-162-01
MBC Mac Quadra	26-018-01
MBC Sun Sparc HR	26-424-01
MBC SGI/13W3 HR	26-425-01

Laptop breakout cables*	Part number
LBC VGA HR 6'	26-244-01
LBC VGA HR 6' A	26-441-02
LBC Mac HR 6'	26-363-01
LBC Mac HR 6' A	26-442-02
LBC Sun HR 6' (61 kHz)	26-413-01
LBC Sun HR 6' A (61 kHz)	26-443-02
LBC Sun HR 6' (71 kHz)	26-413-02
LBC Sun HR 6' A (71 kHz)	26-444-02
LBC Sun HR 6' (81 kHz)	26-413-03
LBC Sun HR 6' A (81 kHz)	26-445-02

\*Laptop breakout cables are also available in 3' and 12' lengths, with or without audio connections.

(Continued)



Adapter laptop breakout cables (RGB 560)		Part number
Mac 15-pin HD F adapter cable kit w/audio		70-156-01
13W3 15-pin HD F adapter cable kit w/audio		70-157-01

High-resolution cables	Part number
BNC-5-3'HR	26-260-15
BNC-5-6'HR	26-260-01
BNC-5-12'HR	26-260-02
BNC-5-25'HR	26-260-03
BNC-5-50'HR	26-260-04
BNC-5-75'HR	26-260-16
BNC-5-100'HR	26-260-05
BNC-5-3'HRP (plenum)	26-378-01
BNC-5-6'HRP (plenum)	26-378-02
BNC-5-12'HRP (plenum)	26-378-03
BNC-5-25'HRP (plenum)	26-378-04
BNC-5-50'HRP (plenum)	26-378-05
BNC-5-75'HRP (plenum)	26-378-06
BNC-5-100'HRP (plenum)	26-378-07
Bulk installation cable (14-conductor, non-plenum), 500' HR	22-120-02
Bulk installation cable (17-conductor, plenum), 500' HR	22-111-03

## Other Accessories

Category	Product Name	Part Number
Connectors	3-pole, 3.5mm right angle captive screw connector	10-436-11
	5-pole, 3.5mm right angle captive screw connector	10-436-10
	3.5mm stereo plug	10-306-01
Mounting hardware	2-gang mounting bracket kit	70-086-01
	4-gang mounting bracket kit	70-086-02
Literature	RGB 500 Series <u>User's Manual</u>	68-455-02

## Accessories and Part Numbers, cont'd

## Free Manuals Download Website

<http://myh66.com>

<http://usermanuals.us>

<http://www.somanuals.com>

<http://www.4manuals.cc>

<http://www.manual-lib.com>

<http://www.404manual.com>

<http://www.luxmanual.com>

<http://aubethermostatmanual.com>

Golf course search by state

<http://golfingnear.com>

Email search by domain

<http://emailbydomain.com>

Auto manuals search

<http://auto.somanuals.com>

TV manuals search

<http://tv.somanuals.com>