

Frigidaire

SPLIT TYPE ROOM AIR CONDITIONER OWNER'S MANUAL

Models:

- FSC09CH8MV / FSE09CH8MV
- FSC09CH8M / FSE09CH8M
- FSC09CH7M / FSE09CH7M
- FSC12CH8MV / FSE12CH8MV
- FSC12CH8M / FSE12CH8M
- FSC12CH7M / FSE12CH7M
- FSC18CH8MV / FSE18CH8MV
- FSC18CH8M / FSE18CH8M
- FSC18CH7M / FSE18CH7M
- FSC24CH8MV / FSE24CH8MV
- FSC24CH8M / FSE24CH8M
- FSC24CH7M / FSE24CH7M
- FSC09PH8MV / FSE09PH8MV
- FSC09PH8M / FSE09PH8M
- FSC09PH7M / FSE09PH7M
- FSC12PH8MV / FSE12PH8MV
- FSC12PH8M / FSE12PH8M
- FSC12PH7M / FSE12PH7M
- FSC18PH8MV / FSE18PH8MV
- FSC18PH8M / FSE18PH8M
- FSC18PH7M / FSE18PH7M
- FSC24PH8MV / FSE24PH8MV
- FSC24PH8M / FSE24PH8M
- FSC24PH7M / FSE24PH7M

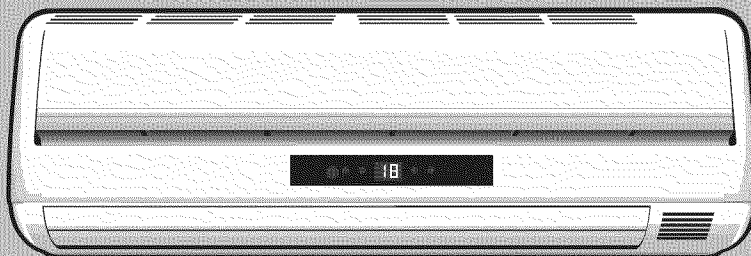

Please read the operating instructions and safety precautions carefully and thoroughly before installing and operating your room air conditioner.

 **From the Electrolux Group.**

Welcome to the world of simple handling and no worries.

Thank you for choosing Frigidaire. This manual contains all of the information required to guarantee your safety and the appropriate use of your air conditioner.

Please read all of the instructions before using the air conditioner and keep this manual for future reference.

We know you will enjoy your new air conditioner and thank you for choosing our product. We hope you will consider us for future purchase.

Important

The air conditioner that you have bought may be slightly different from the one illustrated in this manual. Please refer to the information related to the model you have.

This air conditioner is for domestic use only. It is not recommended for commercial or industrial use.

The air conditioner you have may carry a different plug than the one illustrated in this manual. The plug that comes with the product follows the electrical specification of the country where it is sold.

Contents

Safety precaution	03
Installation	07
Part list.....	09
Indoor unit installation	11
Outdoor unit installation	14
Refrigerant piping connection.....	16
Electrical work	18
Electrical safety.....	24
Gas leak control	24
Test running.....	25
Preparing the device for operation	26
Product description	27
Remote control functions.....	29
Remote control operations.....	31
How the air conditioner works.....	34
Adjusting air flow direction	38
Manual operation	40
Cleaning and maintenance	41
Operation tips.....	43
Troubleshooting tips	45
Environmental advices	46
Technical informations	47

Safety precautions

To prevent injury to the user or other people and property damage, the following instructions must be followed.

Incorrect operation due to ignoring of instructions may cause harm or damage. The seriousness is classified by the following indications.

1. Connect with the power properly. Otherwise, it may cause electric shock or fire due to excess heat generation.
2. Do not modify power cord length or share the outlet with other appliances. It may cause electric shock or fire due to heat generation.
3. Always ensure effective earthing. No earthing may cause electric shock.
4. Disconnect the power if strange sounds, smell, or smoke comes from it. It may cause fire and electric shock.
5. Keep firearms away. It may cause fire.
6. Do not operate or stop the unit by switching on or off the power. It may cause electric shock or fire due to heat generation.
7. Do not operate with wet hands or in damp environment. It may cause electric shock.
8. Do not allow water to run into electric parts. It may cause failure of machine or electric shock.

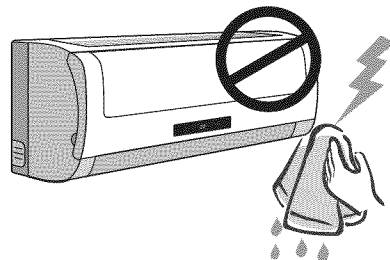
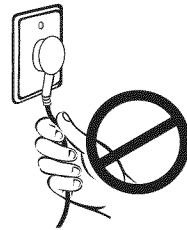
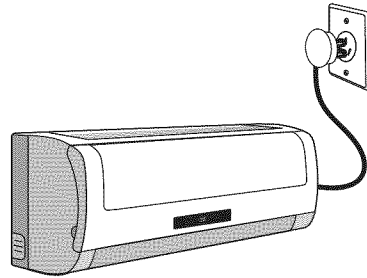

9. Do not drink water drained from air conditioner. It contains contaminants and could make you sick.
10. Do not use the power cord close to heating appliances. It may cause fire and electric shock.
11. Do not damage or use an unspecified power cord. It may cause electric shock or fire.
12. Do not direct airflow at room occupants only. This could damage your health.
13. Always install circuit breaker and a dedicated power circuit. No installation may cause fire and electric shock.
14. Do not open the unit during operation. It may cause electric shock.
15. Do not use the power cord near flammable gas or combustibles, such as gasoline, benzene, thinner, etc. It may cause an explosion or fire.
16. Ventilate room before operating air conditioner if there is a gas leakage from another appliance. It may cause explosion, fire and, burns.
17. Do not disassemble or modify unit. It may cause failure and electric shock.
18. When the air filter is to be removed, do not touch the metal parts of the unit. It may cause an injury.

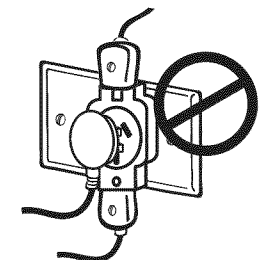
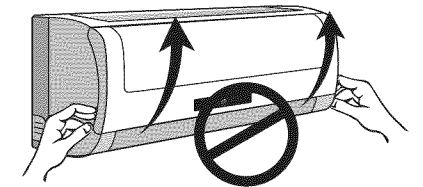
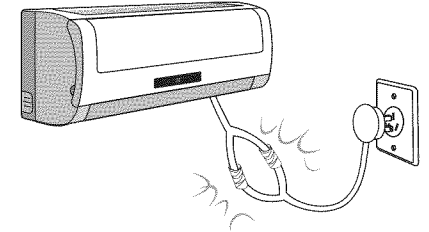
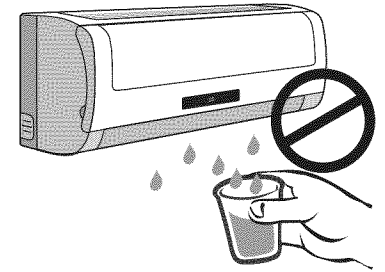

19. Do not clean the air conditioner with water.
Water may enter the unit and degrade the insulation.
It may cause an electric shock.
20. Ventilate the room well when used together with a stove, etc.
An oxygen shortage may occur.
21. When the unit is to be cleaned, switch off, and turn off the circuit breaker.
Do not clean unit when power is on as it may cause fire and electric shock, it may cause an injury.
22. Do not put a pet or house plant where it will be exposed to direct air flow.
This could injure the pet or plant.
23. Do not use for special purposes.
Do not use this air conditioner to preserve precision devices, food, pets, plants, and art objects. It may cause deterioration of quality, etc.
24. Stop operation and close the window in storm or hurricane.
Operation with windows opened may cause wetting of indoor and soaking of household furniture.
25. Do not place obstacles around air-inlets or inside of air-outlet.
It may cause failure of appliance or accident.
26. Turn off the main power switch when not using the unit for a long time.
It may cause failure of product or fire.

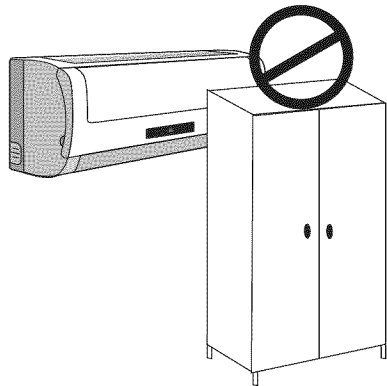
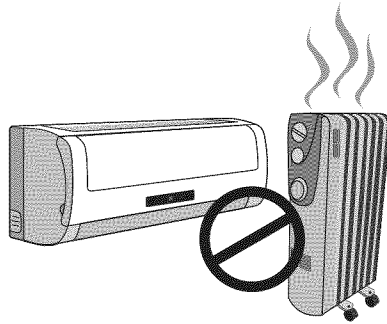
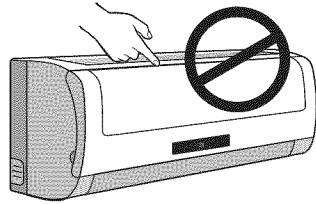

27. Do not use strong detergent such as wax or thinner. Use a soft cloth for cleaning.
Appearance may be deteriorated due to change of product color or scratching of its surface.
28. Ensure that the installation bracket of the outdoor appliance is not damaged due to prolonged exposure.
If bracket is damaged, there is concern of damage due to falling of unit.
29. Always insert the filters securely.
Clean filter once every two weeks.
Operation without filters may cause failure.
30. Do not place heavy object on the power cord and take care so that the cord is not compressed.
There is danger of fire or electric shock.

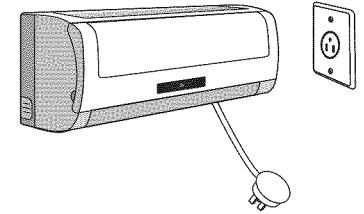

Important

Use caution when unpacking and installing. Sharp edges could cause injury.

If water enters the unit, turn the unit off and disconnect the power, contact a qualified service technician.

Installation

Choosing the installation site

Precautions for installation

Installation at the following sites may cause problems. If you must inevitably install the unit at one of these sites, please consult your local distributor beforehand:

1. Site with machine oil.
2. Sites with a high concentration of salinity, such as coastal areas.
3. Sites with sulfuric gas, such as hot water springs.
4. Sites with high frequency equipment, such as wireless equipment, welding machines and medical installations.
5. Sites with flammable gases or volatile material.
6. Sites with special environmental conditions.
7. Laundry rooms.

Indoor unit

1. The unit must be installed at a site that does not obstruct the flow of air.
2. The site must support the weight of the indoor unit.
3. The site must be easily accessible for maintenance and replacement of the air filter.
4. The site must allow for the necessary space around the indoor unit, as shown in the following figure.
5. There should be at least 1 meter (3 feet) between the unit and radio and television devices. It is ideal that the unit be installed at the center of the environment.
6. It must be far from fire, smoke or flammable gases.
7. The indoor unit must be at least 2.3 meters (7.5 feet) from the ground.
8. The site must allow for the easy removal of the connector pipe and drain hose.
9. The unit must be installed at a site protected from direct sunlight.

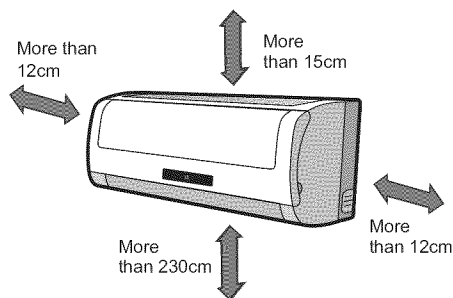

Outdoor unit

1. The outdoor unit must be installed at a convenient site that is not exposed to strong winds. The site should be dry and well ventilated.
2. The site must support the weight of the outdoor unit and allow for vertical installation.
3. There must not be the possibility of increased noise and vibration at the site.
4. The unit must be installed at a site where the noise produced by its operation and air discharge does not disturb the neighbors or animals.
5. The site cannot have any leakage of flammable gases.
6. The site must allow for a piping extension of no less than 5 meters (16 feet) and for pipes measuring at least 10 meters (33 feet) in length.
7. The site must provide enough space around the unit, as shown in the diagram.
8. Children must not be able to access the installation site.

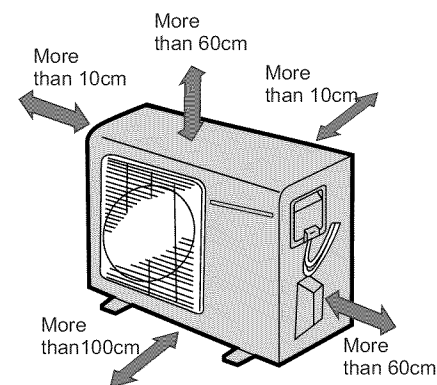

Part list

NUMBER	NAME OF ACCESSORIES	QUANTITY
1	Installation plate	1
2	Clip anchor	8
3	Self-tapping screw A ST3.9X25	8
4	Seal	1
5	Drain Joint	1
6	Connecting Pipe Assembly*	Parts you must purchase
	Liquid side Ø6,35	
	Gas side Ø9,52 (< 12000Btu/h model) Ø12,7 (> 12000Btu/h model)	
7	Remote controller	1
8	Self-tapping screw B ST2.9X10	2
9	Remote controller holder	1

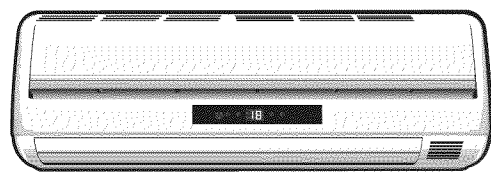

Indoor unit

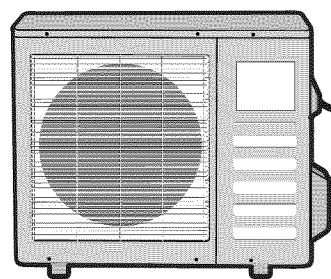
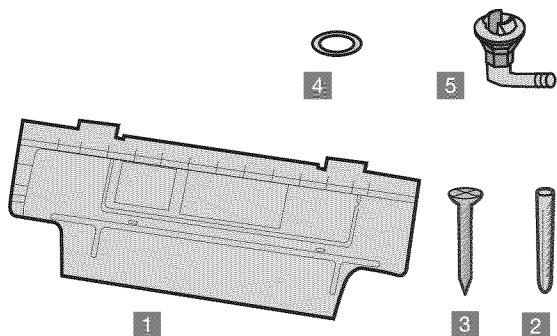
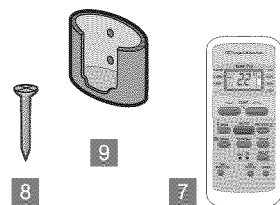

Outdoor unit

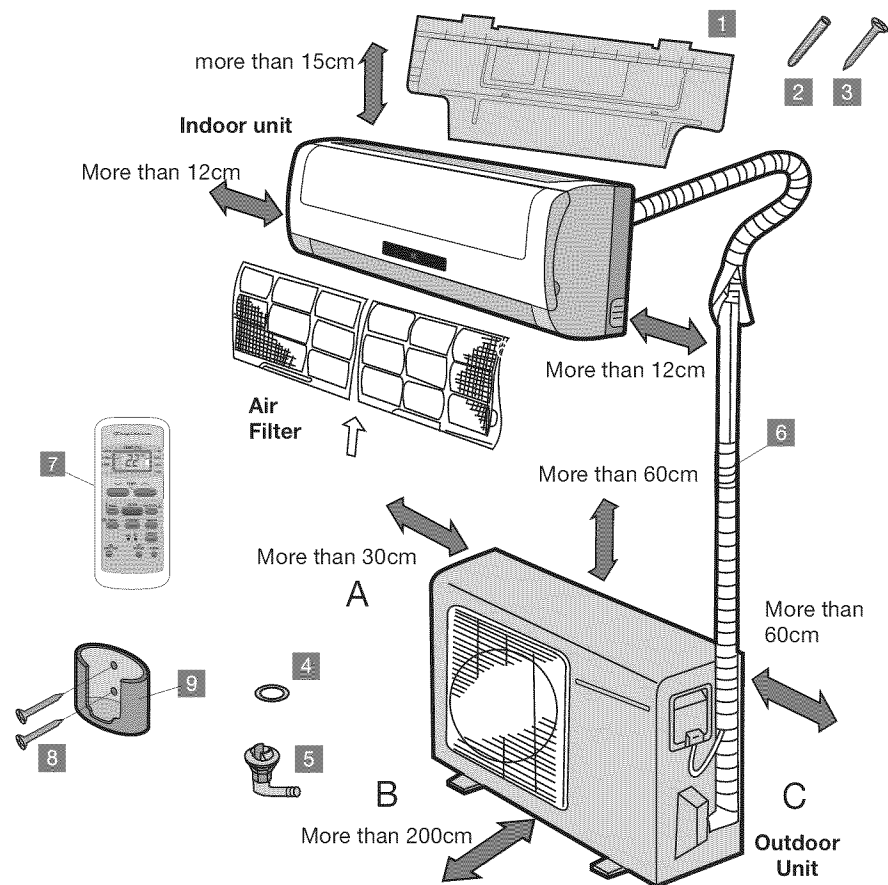

Important

The indoor unit should be installed no lower than 2,3 m.

The pipe needs the minimum of 4 or 5 meters, this distance will contribute to avoid vibration or noise.

Two of the three direction above (A, B, C) should be not be blocket. The copper pipe can be isolated independent.

Indoor unit installation

Installation plate drilling and assembly

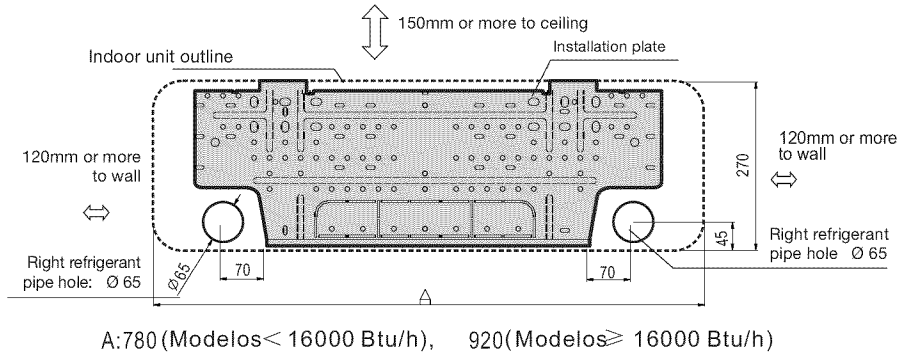

Fixing the installation plate:

1. Fit the installation plate horizontally on structural parts of the wall with spaces around the installation plate.
2. If the wall is made of brick, concrete or the like, drill eight (8) 5mm diameter holes in the wall. Insert Clip anchor for appropriate mounting screws.
3. Fit the installation plate on the wall with eight (8) type "A" screws..

Important

Fit the Installation Plate and drill holes in the wall according to the wall structure and corresponding mounting points on the installation plate. (Dimensions are in "mm" unless otherwise stated)

Placa de instalación

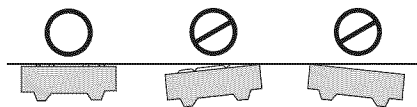

Drill a hole in the wall

1. Determine hole positions according to the diagram detailed in figure beside. Drill one (1) hole (65mm) slanting slightly to outdoor side.
2. Always use wall hole conduit when drilling metal grid, metal plate or the like..

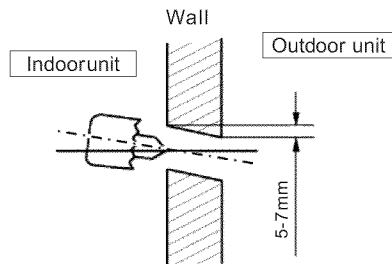

Connective pipe and drainage installation

Drainage

1. Run the drain hose sloping downward. Do not install the drain hose as illustrated beside.
2. When connection extension drain hose, insulate the connecting part of extension drain hose with a shield pipe.

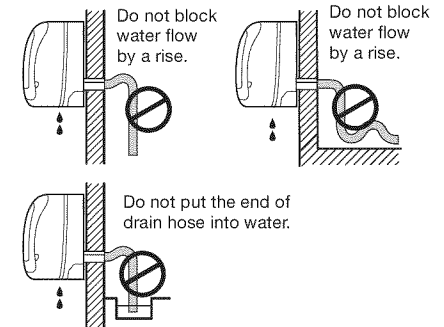

Connection pipe

1. For the left-hand and right-hand piping, remove the rear plate bushing from the left side of the rear plate. Explain to clients that the pipe cover must be kept as it may be used when relocate the air conditioner to any other place.
2. For the left-hand and rear-left-hand piping, install the piping as shown. Bend the connective pipe to be laid at 43mm height or less from the wall.

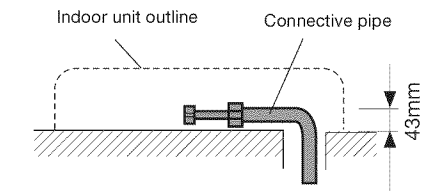
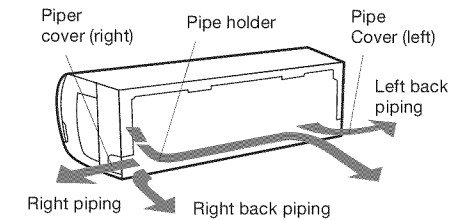

Fastening the indoor unit

Pass the drain hose through the hole in the wall and connect the indoor unit to the installation plate, pressing the indoor part of the installation plate hooks.

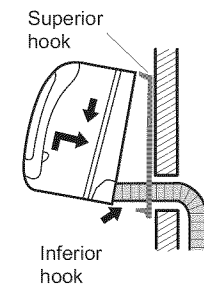

- Piping can easily be made by lifting the indoor unit with a cushion material between the indoor unit and the wall. Get it out after finish piping.
- Push the lower part of the Indoor Unit up on the wall. Then move the Indoor Unit from side to side, up and down to check if it is hooked securely.

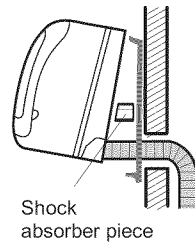

Piping and wrapping

- Wind the connective cable, drain hose and wiring with tape securely, evenly as shown beside.
- Because the condensed water from rear of the indoor unit is gathered in Pond Box and is piped out of room. Do not put anything else in the box.

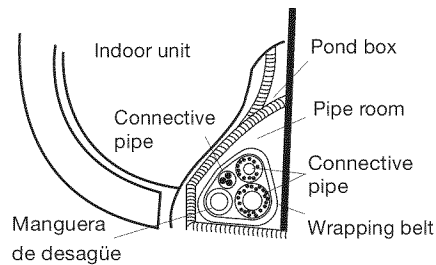

Important

- Connect the indoor unit first then the outdoor unit and bend and arrange the pipe carefully.
- Do not allow the piping to let out from the back of the indoor unit.
- Be careful not to let the drain hose slack.
- Insulate both of the auxiliary piping.
- Be sure that the drain hose is located at the lowest side of the bundle. Locating at the upper side can cause drain pan to overflow inside the unit.
- Never intercross nor intertwist the power wire with any other wiring.
- Run the drain hose sloped downward to drain out the condensed water smoothly.

Outdoor unit installation

- Install the outdoor unit on a rigid base to prevent increasing noise level and vibration.
- Determine the air outlet direction where the discharged air is not blocked.
- In the case that the installation place is exposed to strong wind such as a seaside operation by putting the unit lengthwise along the wall or using a dust or shield plates.
- Specially in windy area, install the unit to prevent the admission of wind.
- If need suspending installation, the installation bracket should accord with technique requirement in the installation bracket diagram. The installation wall should be solid brick, concrete or the same intensity construction, or actions to reinforce, damping supporting should be taken. The connection between bracket and wall, bracket and the air conditioner should be firm, stable and reliable..
- Be sure there is no obstacle which block radiating air.

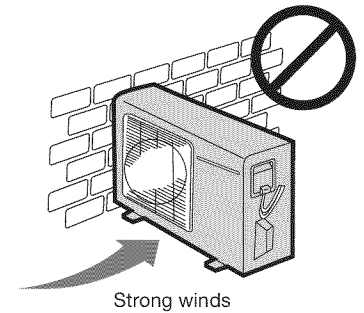
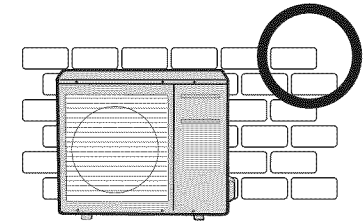

Settlement of outdoor

unit Anchor the outdoor unit with a bolt and nut 10 or 8 tightly and horizontally on a concrete or rigid mount.

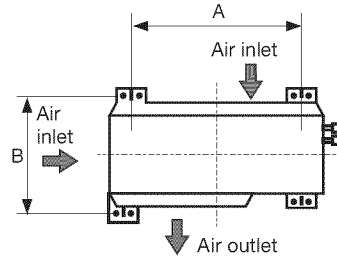

MODEL	A (mm)	B (mm)
≤ 12000 Btu/h	460	276
12000 Btu/h < Model < 18000 Btu/h	458	250
	549	276
≥ 18000 Btu/h	530	290
	549	276
	560	335

Drain elbow installation

Fit the seal into the drain elbow, then insert the drain elbow into the base pan hole of outdoor unit, rotate 90° to securely assemble them. Connecting the drain elbow with an extension drain hose (Locally purchased), in case of the water draining off the outdoor unit during the heating mode.

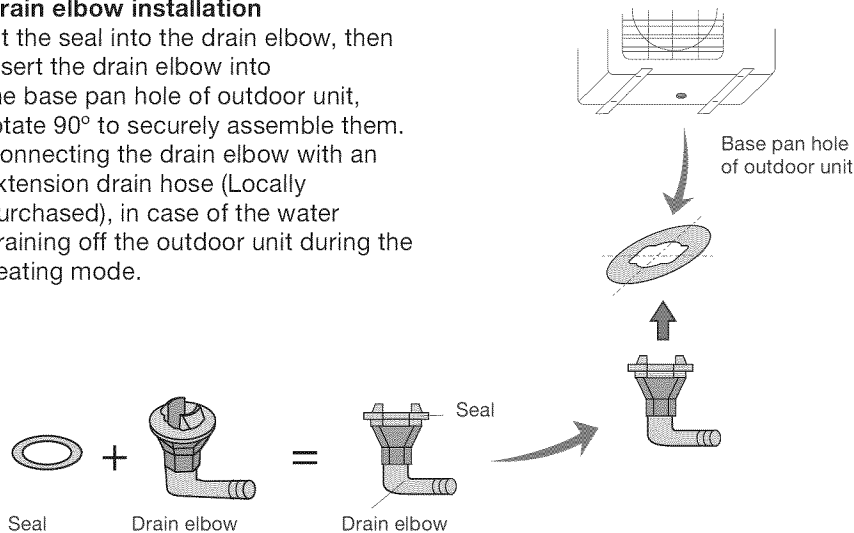

15

Refrigerant piping connection

Flaring work

Main cause for refrigerant leakage is due to defect in the flaring work. Carry out correct flaring work using the following procedure:

- Cut the pipes and the cable.
 - Use the piping kit accessory or pipes purchased locally.
 - Measure the distance between the indoor and the outdoor unit.
 - Cut the pipes a little longer than the measured distance.
 - Cut the cable 1.5m longer than the pipe length.
- Burr removal.
 - Completely remove all burrs from the cut cross section of pipe/tube.
 - Put the end of the copper tube/pipe in a downward direction as you remove burrs in order to avoid dropping burrs into the tubing.
- Putting nut on.
 - Remove flare nuts attached to indoor and outdoor unit, then put them on pipe/tube having completed burr removal. (not possible to put them on after flaring work)

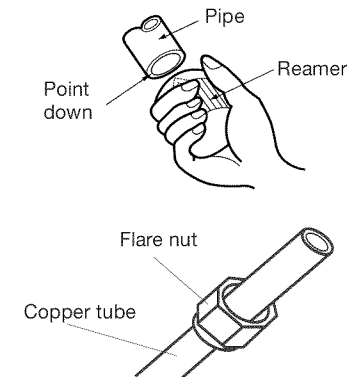
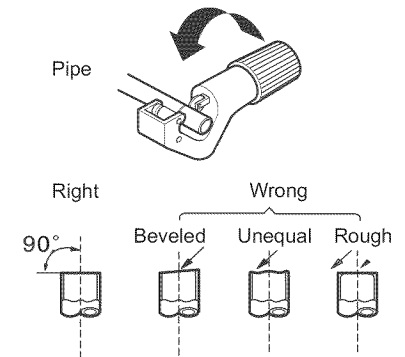

16

4. Flaring work.

A) Firmly hold copper pipe in a die in the dimension shown in the table below.

Outer diam. (mm)	A (mm)	
	Max.	Min.
6,35	1,3	0,7
9,53	1,6	1,0
12,70	1,8	1,0
16	2,4	2,2

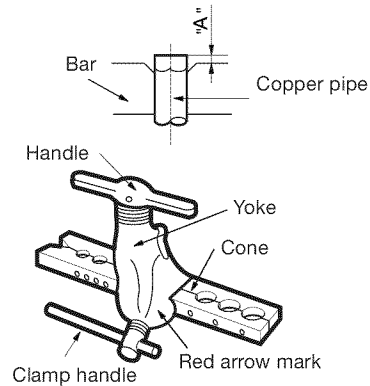

Tightening connection

1. Align pipes to be connected.
2. Sufficiently tighten the flare nut with fingers, and then tighten it with a spanner and torque wrench as shown.

Caution: Excessive torque can break nut depending on installation conditions.

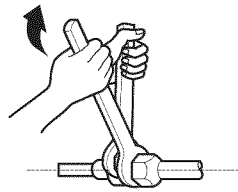
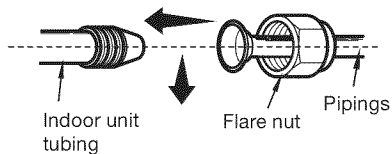

Outer diam.	Tightening torque(N.cm)	Additional tightening torque(N.cm)
6.35	1570 (160 kgf/cm)	1960 (200 kgf/cm)
9.53	2940 (300 kgf/cm)	3430 (350 kgf/cm)
12,70	4900 (500 kgf/cm)	5390 (550 kgf/cm)
16	7360 (750 kgf/cm)	7850 (800 kgf/cm)

Electrical work

Electric safety regulations for the initial installation

1. If there is serious safety problem about the power supply, the technicians should refuse to install the air conditioner and explain to the client until the problem is solved.
2. Power voltage should be in the range of 90%~110%of rated voltage.
3. The creepage protector and main power switch with a 1.5 times capacity of Max. Current of the unit should be installed in power circuit.
4. Ensure the air conditioner is grounded well.
5. According to the attached Electrical Connection Diagram located on the panel of the outdoor unit to connect the wire.
6. All wiring must comply with local and national electrical codes and be installed by qualified and skilled electricians.
7. An individual branch circuit and single receptacle used only for this air conditioner must be available. See the following table for suggested wire sizes and fuse specifications:

MODEL	Power supply	Input Rated Amp (Switch/Fuse)	Power Cord Size
< 9000 Btu/h	220-230V~/ 60Hz	16A	1,0 ~1,5 mm ²
9000 Btu/h < Modelo < 12000 Btu/h	220-230V~/ 60Hz	16A	1,5 mm ²
12000 Btu/h < Modelo < 18000 Btu/h	220-230V~/ 60Hz	20A	2,5 mm ²
18000 Btu/h < Modelo < 24000 Btu/h	220-230V~/ 60Hz	25/32A	
> 24000 Btu/h	220-230V~/ 60Hz	45/30A	Outdoor unit supply > 2,5 mm ²

Note: The supply voltage must be consistent with the rate voltage of the air conditioner.

Connect the cable to the indoor unit

1. Indoor/Outdoor connection cable should be H07RN-F type.
2. Remove the screw, then remove the window cover.
3. Connect cables according to their marks to terminals.
4. Wrap those cables not connected with terminals with insulation tapes, so that they will not touch any electrical components.

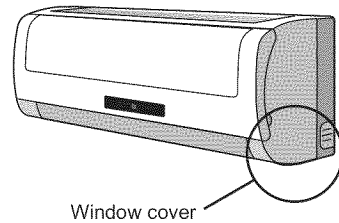

Cooling only type.

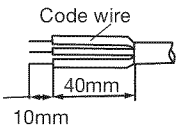

Cooling & heating

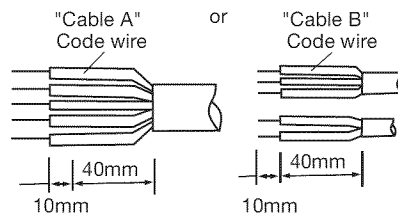

Coil type

"Connector A"
Terminal block of indoor unit

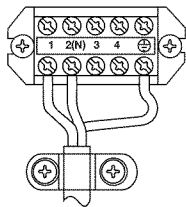

To outdoor unit

Cooling & heating

"Connector A" or "Connector B"
Terminal block of indoor unit

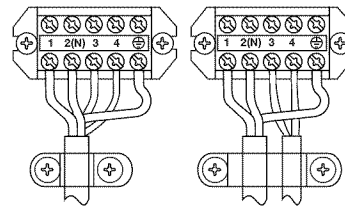

To outdoor unit

To outdoor unit

Connect the cable to the outdoor unit

1. Remove the electric parts cover from the outdoor unit.
2. Connect the connective cables to the terminals as identified with their respective matched numbers on the terminal block of indoor and outdoor units.
3. To prevent the ingress of water, from a loop of the connective cable as illustrated in the installation diagram of indoor and outdoor units.
4. Insulate unused cords (conductors) with PVC-tape. Process them so they do not touch any electrical or metal parts.

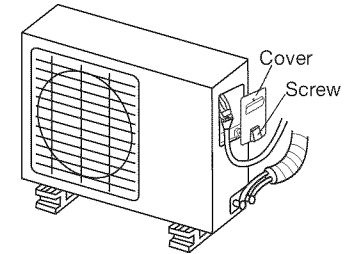

Cooling only type.

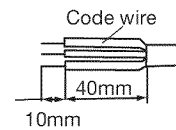

< 12000 Btu/h (Cooling)
Wire connector of outdoor unit

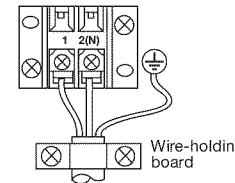

Cooling & heating

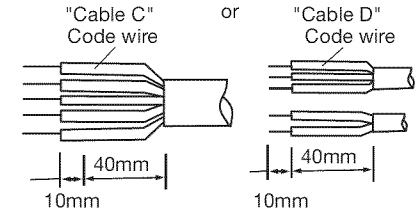

< 12000 Btu/h (Cooling/Heating)
Wire connector of outdoor unit

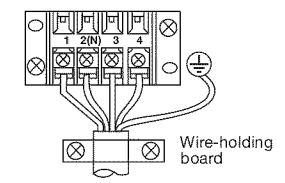

≥ 12000 Btu/h (Cooling)

"Connector C" or "Connector D"
Wire connector of outdoor unit

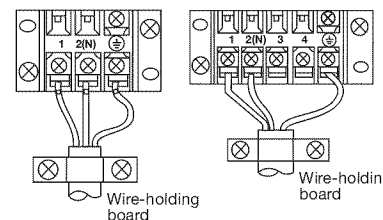

≥ 12000 Btu/h (Cooling/Heating)

"Connector E" or "Connector F"
Wire connector of outdoor unit

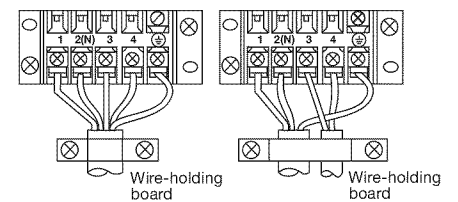

Caution:

After the confirmation of the above conditions, prepare the wiring as follows:

1. Never fail to have an individual power circuit specifically for the air conditioner. As for the method of wiring, be guided by the circuit diagram posted on the inside of control cover.
2. The screw which fasten the wiring in the casing of electrical fittings are liable to come loose from vibrations to which the unit is subjected during the course of transportation. Check them and make sure that they are all tightly fastened. (If they are loose, it could cause burn-out of the wires.)
3. Specification of power source.
4. Confirm that electrical capacity is sufficient.
5. See to that the starting voltage is maintained at more than 90 percent of the rated voltage marked on the name plate.
6. Confirm that the cable thickness is as specified in the power source specification.
7. Always install an earth leakage circuit breaker in a wet or moist area.
8. The following would be caused by voltage drop. Vibration of a magnetic switch, which will damage the contact point, fuse breaking, disturbance of the normal function of the overload.
9. The means for disconnection from a power supply shall be incorporated in the fixed wiring and have an air gap contact separation of at least 3mm in each active (phase) conductors.

Air purge

The air and moisture that remain in the refrigeration system have undesirable effects, as detailed below:

- | | |
|---|---|
| <ol style="list-style-type: none"> 1. Pressure in the system rises. 2. Operating current rises.. 3. Cooling or heating efficiency drops. 4. Moisture in the refrigerant circuit may freeze and block capillary tubing. 5. Water may lead to corrosion of | <ol style="list-style-type: none"> 6. Therefore, the indoor unit and tubing between the indoor and outdoor unit must be leak tested and evacuated to remove any noncondensables and moisture from the system.. |
|---|---|

Air purging with vacuum pump

1. Check that each tube (both liquid and gas side tubes) between the indoor and outdoor units have been properly connected and all wiring for the test run has been completed. Remove the service valve caps from both the gas and the liquid side on the outdoor unit. Note that both the liquid and the gas side service valves on the outdoor unit are kept closed at this stage.
2. When relocate the unit to another place, perform evacuation using vacuum pump.
3. To type refrigerant R407C, make sure the refrigerant added into the air conditioner is liquid form in any case.
4. Pipe length and refrigerant amount:

Connective pipe length	Air purging method	Additional amount of refrigerant to be charged	
Less than 5m	Use vacuum pump.	—————	
5~10 m	Use vacuum pump.	Liquid side: 6,35 (Pipe length--5x30g)	Liquid side: 6,35 (Pipe length--5x65g)

Caution in handling the packed valve

1. Open the valve stem until it hits against the stopper. Do not try to open it further.
2. Securely tighten the valve stem cap with a spanner or the like. Valve stem cap tightening torque (See tightening torque table in page 17).

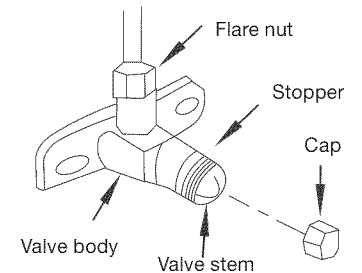
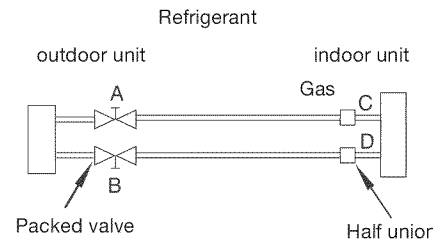

Using the vacuum pump

1. Completely tighten the flare nuts, A, B, C, D, connect the manifold valve charge hose to a charge port of the low-pressure valve on the gas pipe side.
2. Connect the charge hose connection to the vacuum pump.
3. Fully open the handle Lo of the manifold valve.
4. Operate the vacuum pump to evacuate. After starting evacuation, slightly loose the flare nut of the Lo valve on the gas pipe side and check that the air is entering (Operation noise of the vacuum pump changes and a compound meter indicates 0 instead of minus)
5. After the evacuation is complete, fully close the handle Lo of the manifold valve and stop the operation of the vacuum pump. Make evacuation for 15 minutes or more and check that the compound meter indicates -76cmHg (-1x10 Pa).
6. Turn the stem of the packed valve B about 45o counterclockwise for 6~7 seconds after the gas coming out, then tighten the flare nut again. Make sure the pressure display in the pressure indicator is a little higher than the atmosphere pressure.

7. Remove the charge hose from the Low pressure charge hose.
8. Fully open the packed valve stems B and A.
9. Securely tighten the cap of the packed valve.

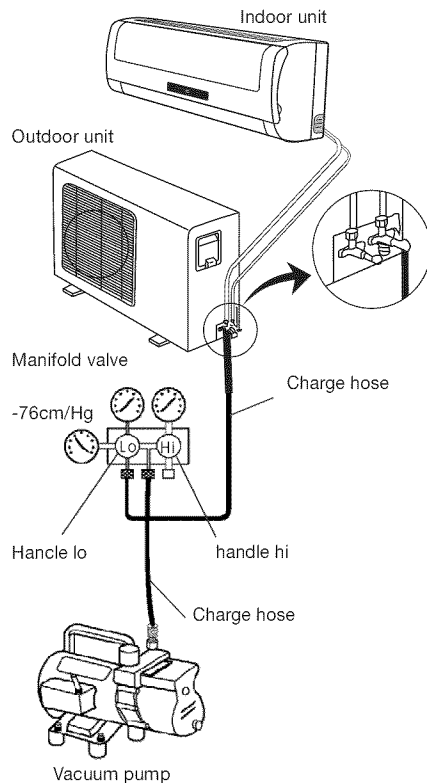

Electrical safety

Check the electrical safety before finalizing the installation.

1. The insulation resistance must be higher than 2Ω .
2. Grounding. After completing this step, measure its resistance with a tester. Confirm that the grounding resistance is lower than 4Ω .
3. Check for electrical leaks (complete this step during the startup test). During the test operation, performed after completing the installation, use an electric tester and a multimeter to check for electrical leaks. Unplug the unit immediately if any leakage is detected.

Revise and determine the necessary solutions until the unit is operating perfectly.

Gas leak control

Leak detector

Use the leak detector to determine whether there is any leakage.

Water and soap method

Apply a solution of water and soap or neutral liquid detergent to the indoor unit connection or outdoor unit connections with a soft brush to check for leaks in the connection points. If bubbles appear, the tubes are leaking.

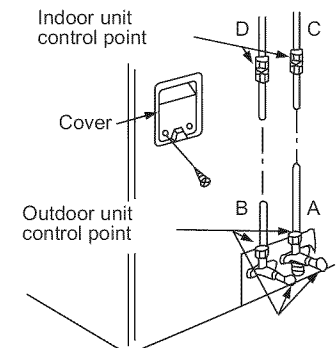

A= Lo valve
B = Hi valve
C & D are the indoor unit connection ends

Test running

Perform test running after completing gas leak and electrical safety check. The test running time should last more than 30 minutes.

1. Open the panel and lift the panel up to an angle which remains fixed. Do not lift the panel any further when it stops with a click sound.
2. Press the manual control button twice until the operating indicator lights up, the unit will operate on Forced Cool mode.
3. Check if all the functions works well during test running. Especially check whether the drainage of indoor unit is smooth or not.
4. Press the manual switch button again after finishing the test running. The operating indicator turns dark and the unit stops operating.

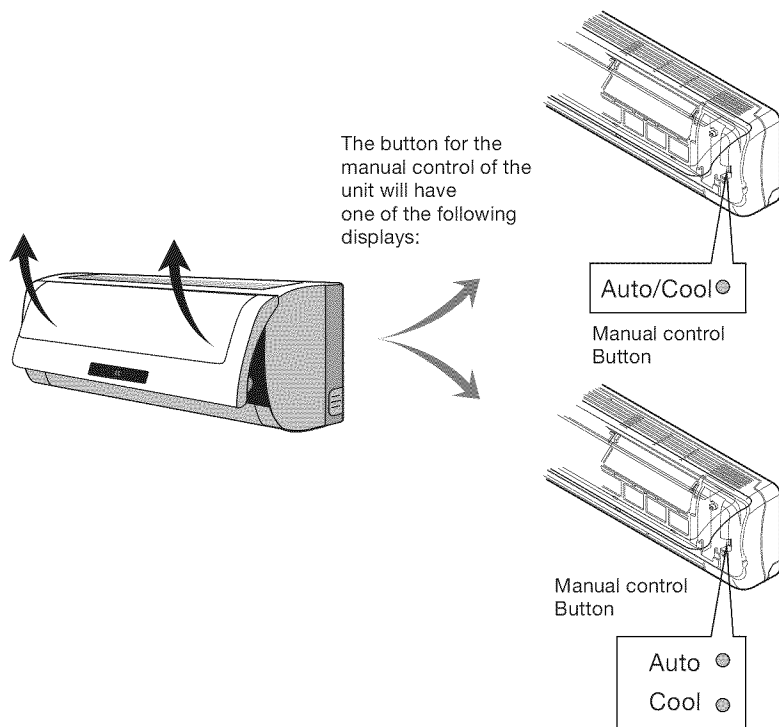

Preparing the device for operation

1. Contact a specialist to install the device.
2. Guarantee that the unit is appropriately fastened and complies with all of the aforementioned safety norms.
3. Before operating the air conditioner, ensure that the air filter is installed correctly.
4. If the unit has been out of use for a long period of time, it is recommended that the air filter be cleaned before use. During continuous use, clean the air filter every two weeks.
5. This air conditioner was designed for use under the following conditions:

MODE					
Cooling operation		Heating operation		Drying operation	
Temperature		Temperature		Temperature	
Inside	Outside*	Inside	Outside	Inside	Outside
17°C~32°C	18°C~43°C	17°C~30°C	-7°C~24°C	17°C~32°C	11°C~43°C

* (-5°C~43°C only cool system)

Important

1. If air conditioner is used outside of the above conditions, certain safety protection features may come into operation and cause the unit to function abnormally.
2. Room relative humidity less than 80%. If the air conditioner operates in excess of this figure, the surface of the air conditioner may attract condensation. Please sets the vertical air flow louver to its maximum angle (vertically to the floor), and set HIGH fan mode.
3. Optimum performance will be achieved within these operating temperature.

Product description

- 1** Front panel frame
- 2** Front panel
- 3** Air filter
(inside the front panel)
- 4** Horizontal airflow grille
- 5** Vertical airflow louver
- 6** Indoor temperature sensor
(inside the frontal panel)
- 7** Display panel
- 8** Infrared signal receiver
- 9** Connection for the drain hose and
for the refrigerant pipe

- 10** Remote controller
- 11** Electric wiring
- 12** Stop valve
- 13** Drain hose,
refrigerant connecting pipe

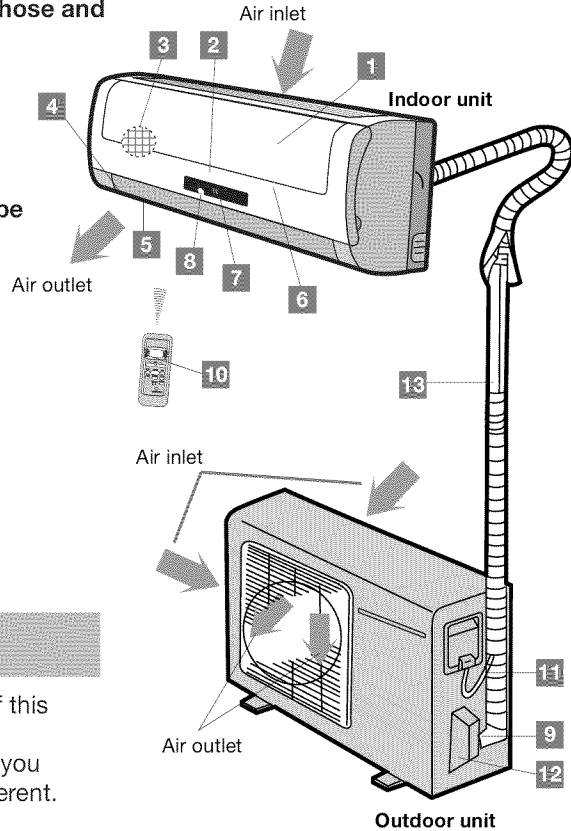

Important

All drawing and illustrations of this manual are just for general information. The product that you purchased can be slightly different.

Display panel (indoor unit)

- 13** Infrared signal receptor
- 14** **Auto:** When you set the air conditioner to AUTO mode, the indicator starts flashing.
- 15** **Defrost** (only heating model): This indicator illuminates when the air conditioner starts defrosting automatically or when the warm air control feature is activated in heating operation.
- 15** **Fan only:** When you set the air conditioner to FAN mode only, the indicator starts flashing.
- 16** **Digital display:** Displays the temperature settings when the air conditioner is operational.
- 17** **Operation:** This indicator flashes once per second after power is on and illuminates when the air conditioner is in operation.
- 18** **Timer:** This indicator illuminates when TIMER is set ON.

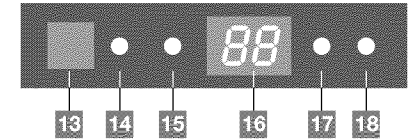
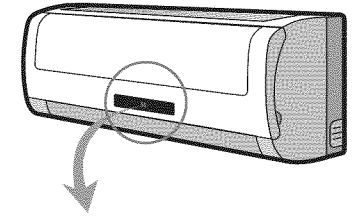

OR

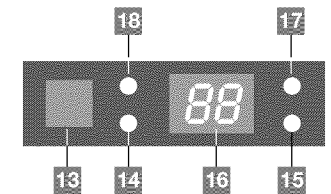

Remote control functions

Performance features

1. Operating Mode: AUTO, COOL, DRY, HEAT(Cooling only model without) and FAN .
2. Timer Setting Function in 24 hours.
3. Indoor Setting Temperature Range: 17 C~30 C.
4. Full function of LCD (Liquid Crystal Display)
5. Function of night light.



Cooling/heating model

Cooling model

Remote controller specifications

Rated voltage	3 V
Lowest of voltage of CPU emitting signal	2 V
Transmission distance	8 m*
Environment	-5°C ~ 60°C

* (with 3 V, it reaches 11 m)

Important

1. Keeps the remote control far from liquids.
2. Protects the remote control of high temperatures and radiation exposition.
3. Keeps the internal receiver protect of the light of the sun. Otherwise, it can presents functioning imperfections.
4. Keeps the remote control far from EMI (electromagnetic interferences) produced by other machines.

Install / replace batteries

The remote controller uses two alkaline dry batteries (R03/LR03X2).

1. To install batteries, slide back the cover of the battery compartment and install the batteries according to the directions (+and-) show on the remote controller.
2. To replace the old batteries, use the same method as mentioned above.

Important

1. When replacing batteries, do not use old batteries or a different type battery. This may cause the remote control malfunction.
2. If you do not use the remote controller for several weeks remove the batteries. Otherwise battery leakage may damage the remote controller.
3. The average battery life under normal use is about 6 months.
4. Replace the batteries when there is no answering beep from the indoor unit or if the Transmission indicator light fails to light.

Remote control operations

1 TEMP Button  : Push this button to decrease the indoor temperature setting.

2 .MODE: Each time the button is pressed, the operation mode is shifted in the direction of the arrow:



* Note: COOL only model has no HEAT feature.

3 SWING: Push this switch button to change the louver angle.

4 ECONOMIC: When you push ECONOMIC button during cooling, heating (cooling only type without), or AUTO operation, the air conditioner will start following operation. The fan speed will be automatically controlled. In the operation suppression zone where capacity is kept to the minimum, overcooling is prevented by raising the temperature setting by 1°C after 1 hour and by 2°C after 2 hours of operation. The room temperature is thus regulated between the operation suppression zone and the set temperature. (It depends on the outdoor temperature.)

5 RESET: When you press the recessed RESET button, all current settings are cancelled and the control will return to the initial settings.

6 AIR DIRECTION: Press this button and release it quickly, the

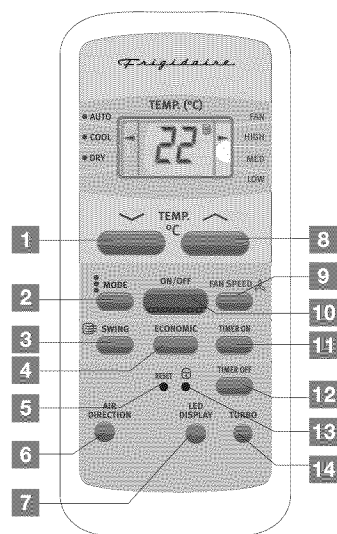

Cooling model

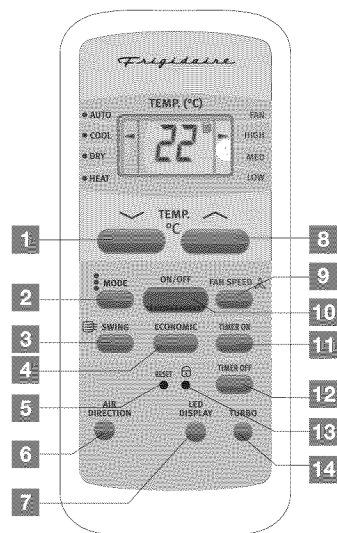

Cooling/heating model

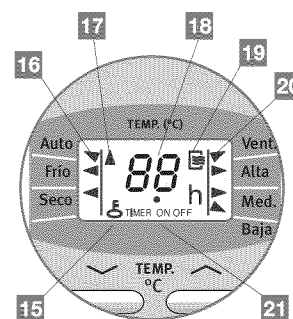

Display: cooling model

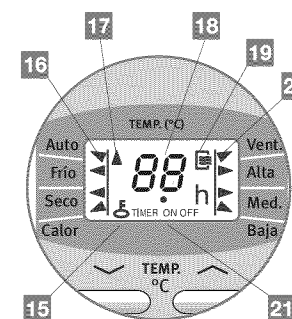

Display: cooling/heating model

directional swing feature of the horizontal louver is activated. The louver swings for a certain angle for each press. If keep pressing the button for more than 2 seconds, the Auto swing feature will be activated. Press it again, the louver stops moving. When the louver swing at a position which would affect the cooling and heating effect of the air conditioner, it would automatically change the swing direction (Not applicable to units without this function).

7 LED DISPLAY: Press this button to clear the digit display in the air conditioner, press it again to activate it.

8 TEMP Button  : Push this button to increase the indoor temperature setting.

9 FAN SPEED: Used to select the Fan Speed in four steps - AUTO, LOW, MED or HIGH. Each time the

button is pressed, the fan speed mode is shifted.

10 ON/OFF: Push this button to start operation, push the button again to stop operation.

11 TIMER ON: Press this button to initiate the auto-on time sequence. Each press will increase the auto-timed setting in 30 minutes increments. When the setting time displays 10:00, each press will increase the auto-timed setting 60 minutes increments. To cancel the auto-timed program, simply adjust the auto-on time to 0:00.

12 TIMER OFF: Press this button to initiate the auto-off time sequence.

13 LOCK: When you press the recessed LOCK button, all current settings are locked in and the remote controller does not accept any operation except that of the LOCK. Press again to cancel the LOCK mode.

How the air conditioner works

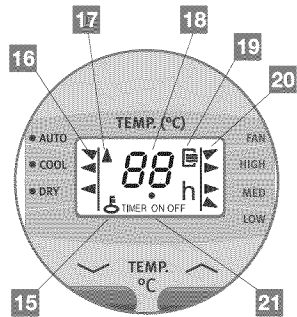

Display: cooling model

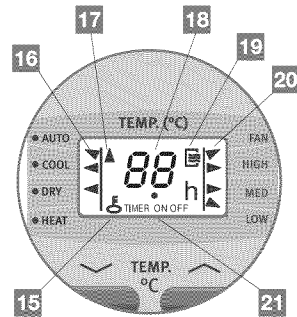

Display: cooling/heating model

- 14 TURBO:** Push this button on COOL mode, the air conditioner goes into powerful cooling operation. Push again to cancel the TURBO function (for only cooling/heating model).
- 15 LOCK INDICATOR:** LOCK display is displayed by pushing the LOCK button. Push the LOCK button to clear display.
- 16 OPERATION MODE Indicator:** When press the MODE button, it shows the current operating mode: AUTO, COOL, DRY, HEAT (only cooling/heating model) or FAN mode.
- 17 TRANSMISSION INDICATOR:** This indicator flashes one time when remote controller transmits signals to the indoor unit.
- 18 DIGITAL DISPLAY AREA:** This area will show the set temperature and, if in the TIMER mode, will

- show the ON and OFF settings of the TIMER. If in the FAN mode, nothing is appeared.
- 19 ON/OFF INDICATOR:** This symbol appears when the unit is turned on by the remote controller, and disappear when the unit is turned off.
- 20 FAN SPEED INDICATOR:** Press the FAN SPEED button to select the desired fan speed setting (Auto-Low-Med-High).
- 21 TIMER DISPLAY INDICATOR:** This display area shows the settings of the TIMER. That is, if only the starting time of operation is set, it will display the TIMER ON. If only the turning off time of operation is set, it will display the TIMER OFF. If both operations are set, it will show TIMER ON-OFF which indicates you have chosen to set both the starting time and off time.

AUTOMATIC OPERATION

Switch on the power and the OPERATION indication lamp on the display panel of the indoor unit starts flashing, and turns off after flashes for 6 times.

1. Use the MODE button to select AUTO.
2. Push the TEMP button to set the desired room temperature . The most comfortable temperature settings are between 21C o to 28C.
3. Push the ON/OFF button to start the air conditioner. The OPERATION lamp on the display panel of the indoor unit lights. The FAN SPEED is automatically set and there are no fan speed indicators shown on the display panel of the remote controller.
4. Push the ON/OFF button again to stop the unit operation..

Important

In the AUTO mode, the air conditioner can logically choose the mode of COOL, FAN and HEAT by sensing the difference between the actual ambient room temperature and the set temperature on the remote controller.

COOL/ HEAT (Cooling only model without) and FAN Operation.

If the AUTO mode is not comfortable, you may manually over-ride the settings by using COOL, HEAT or FAN modes.

1. Push the TEMP button to set the desired room temperature. When in COOLING mode, the most comfortable settings are 21 C or above. When in HEATING mode, the most comfortable settings are 28 C or below.
2. Push the FAN SPEED to select the FAN mode of AUTO, HIGH, MED or LOW.
3. Push the ON/OFF button, the operation lamp lights and the air conditioner start to operate as your settings. Push the ON/OFF button again to stop this unit operation.

Important

The FAN mode can not be used to control the temperature. While in this mode, only steps 2 and 3 may be performed.

ECONOMIC mode

Press the ECONOMIC key to active the ECONOMIC mode. Press this button again to deactivate it.

In the cold and dry modes:

- The indoor unit fan can be set on low speed.
- After one hour of operation, the adjusted temperature will increase 1°C (34°F) . After one hour, the temperature will increase another 1°C (34°F). The unit will continue to operate 2°C (36°F) above the adjusted temperature.

In heating mode:

- The indoor unit fan can be set on low speed.
- After one hour of operation, the adjusted temperature will drop 2°C (36°F). After one hour, the temperature will drop 2°C (36°F) once again. The unit will continue operating 4°C (39°F) below the adjusted temperature.

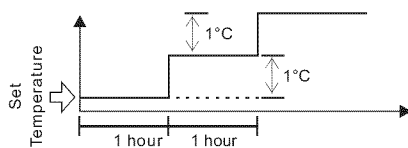

ECONOMIC operation - Cooling

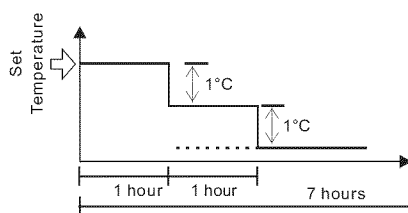

ECONOMIC operation - Heating

TIMER Operation

Push TIMER ON button to set the auto- on time and TIMER OFF button to set the auto-off time.

To set the starting time

1. Push the TIMER ON button, then the remote controller shows TIMER ON , the last set time for the starting operation and the signal "h" will be shown on the DIGITAL DISPLAY area. You are now ready to reset the time to START the operation.
2. Push the TIMER ON button again to set desired unit start time.
3. After setting the TIMER ON ,there will be a one-half second delay before the remote controller transmits the signal to the air conditioner. Then, after approximately another 2 seconds, the signal "h" disappears and the set temperature will re-appear on the digital display.

To set the stopping time

1. Push the TIMER OFF button and the remote controller will show TIMER OFF, the last set time for the stopping operation and the signal "h" will be shown on the DIGITAL DISPLAY area. You are now ready to reset the time of the STOP operation.
2. Push the TIMER OFF button again to set the time you want to stop the operation.
3. After setting the TIMER OFF ,there will be a one-half second delay before the remote controller transmits the signal to the air conditioner. Then, after approximately another 2 seconds, the signal "h" disappears and the set temperature will re-appear on the digital display.

DRY Operation

The dry mode will automatically select the drying operation based on the difference between the set temperature and the actual room temperature. The temperature is regulated while dehumidifying by repeating turning on and off of the cooling operation or fan only.

1. Push the MODE button to select DRY.
2. Push the TEMP button to set the desired temperature from 21C to 28C.
3. Push the ON/OFF button, the OPERATION lamp lights and the air conditioner starts to operate in DRY mode at LOW fan speed. Push the ON/OFF button again to stop this unit operation.

Important

Due to the difference of the set temperature of the unit and the actual indoor temperature, the Air Conditioner when in DRY mode will automatically operate many times without running the COOL and FAN mode.

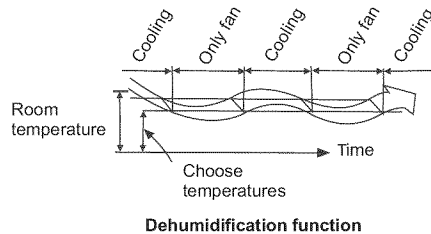

Important

Optimal operation

To achieve optimal performance, please note the following:

1. Adjust the air flow direction correctly so that it is not directed on people.
2. Adjust the temperature to achieve the highest comfort level. Do not adjust the unit to excessive temperature levels.
3. Close doors and windows on COOL or HEAT modes, or performance may be reduced.
4. Use TIMER ON button on the remote controller to select a time you want to start your air conditioner.
5. Do not put any object near air inlet or air outlet, as the efficiency of the air conditioner may be reduced and the air conditioner may stop running.
6. Clean the air filter periodically, otherwise cooling or heating performance may be reduced.
7. Do not operate unit with horizontal louvre in closed position.

Adjusting air flow direction

Adjust the air flow direction properly otherwise, it might cause discomfort or cause uneven room temperatures.

Adjust the horizontal louver using the remote controller.

Adjust the vertical louver manually.

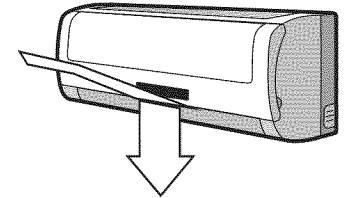

Adjusting the Vertical Air Flow Direction (up-down)

The air conditioner automatically adjusts the vertical air flow direction in accordance with the operating mode.

To set the vertical air flow direction

Perform this function while the unit is in operation.

Keep pressing the AIR DIRECTION button on the remote controller to move the louver to the desired direction.

- Adjust the vertical air flow direction to the desired direction.
- In subsequent operations, the vertical air flow is automatically set in the direction to which you adjusted the louver by pressing the AIR DIRECTION button.

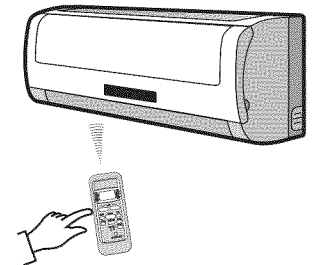

To set the horizontal air flow direction (left - right)

Adjust the horizontal louver manually using the lever on the left or right side of the vertical louver arm (Depending on model). Take care not to catch fingers on the fan, horizontal louver or to damage vertical louvers. When the air conditioner is in operation and the

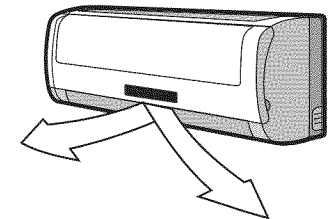

horizontal louver is in a specific position, move the lever at left (or right, depending on model).

- Adjust the air flow direction properly otherwise, it might cause discomfort or cause uneven room temperatures.
- Adjust the horizontal louver using the remote controller.
- Adjust the vertical louver manually.

Adjusting the Vertical Air Flow Direction (up-down)

The air conditioner automatically adjusts the vertical air flow direction in accordance with the operating mode.

To set the vertical air flow direction

Perform this function while the unit is in operation. Keep pressing the AIR DIRECTION button on the remote controller to move the louver to the desired direction.

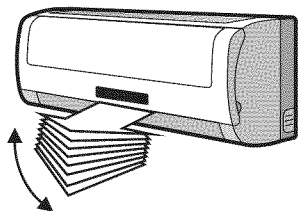

Important

- The AIR DIRECTION and SWING buttons will be disabled when the air conditioner is not in operation (including when the TIMER ON is set).
- Do not operate the air conditioner for long periods with the air flow direction set downward in cooling or dry mode. Otherwise, condensation may occur on the surface of the horizontal louver causing moisture to drop on to the floor or on furnishings.
- Do not move the horizontal louver manually. Always use the AIR DIRECTION or SWING button. If you move this louver manually, it may malfunction during operation. If the louver malfunctions, stop the air conditioner once and restart it.
- When the air conditioner is started immediately after it was stopped, the horizontal louver might not move for approximately 10 seconds.
- Open angle of the horizontal louver should not be set too small, as COOLING or HEATING performance may be impaired due to too restricted air flow area.
- Do not operate unit with horizontal louver in closed position.
- When the air conditioner is connected to power (initial power), the horizontal louver may generate a sound for 10 seconds, this is a normal operation.

Manual operation

Manual operation can be used temporarily in case you can not find the remote controller or its batteries are exhausted.

1. Open and lift the front panel up to an angle until it remains fixed with a clicking sound.
2. Push the button until the AUTO indicator is lit, the unit will work in forced AUTO mode (the default setting temperature is 24°C).
3. Close the panel firmly to its original position.

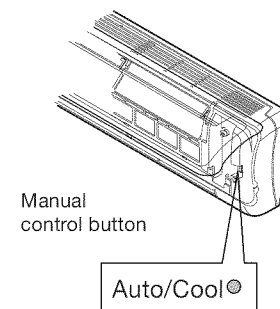
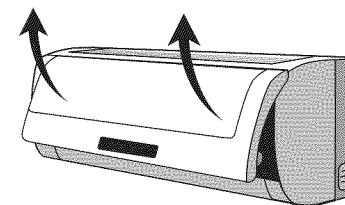

Important

Once you push the manual button, the operation mode is shifted in an order as: AUTO, COOL, OFF.

Push the manual button until the OPERATION indicator flashes rapidly (five times per second), the unit now is operating in forced COOL mode. This is used for testing purposes only. When the OPERATION indicator goes off, the air conditioner is OFF.

To restore the remote controller operation, use the remote controller directly. On forced COOL mode, the remote operation function is unavailable. · Open and lift the front panel up to an angle until it remains fixed with a clicking sound. Push the AUTO button and the air conditioner will run in AUTO mode. Close the panel firmly to its original position.

NOTE: The "COOL" mode on the control board is only provided for testing purposes.

Cleaning and maintenance

Cleaning the air filter

A clogged air filter reduces the cooling efficiency of this unit. Please clean the filter once every 2 weeks.

1. Lift the indoor unit panel up to an angle until it stops with a clicking sound.
2. Take hold of the handle of the air filter and lift it up slightly to take it out from the filter holder, then pull it downwards.
3. Remove the AIR FILTER from the indoor unit.
Clean the AIR FILTER once two weeks.
Clean the AIR FILTER with a vacuum cleaner or water, then dry it up in cool place.
4. Remove the air freshening filter from its support frame (The installation and removing method of the air freshening filter is different depending on the models, see the pictures marked 1 and 2 on the left). Clean the air freshening filter at least once a month, and replace it every 4-5 months.
Clean it with vacuum cleaner, then dry it in cool place.
5. Install the air freshening filter back into position.
6. Insert the upper portion of air filter back into the unit taking care that the left and right edges line up correctly and place filter into position.

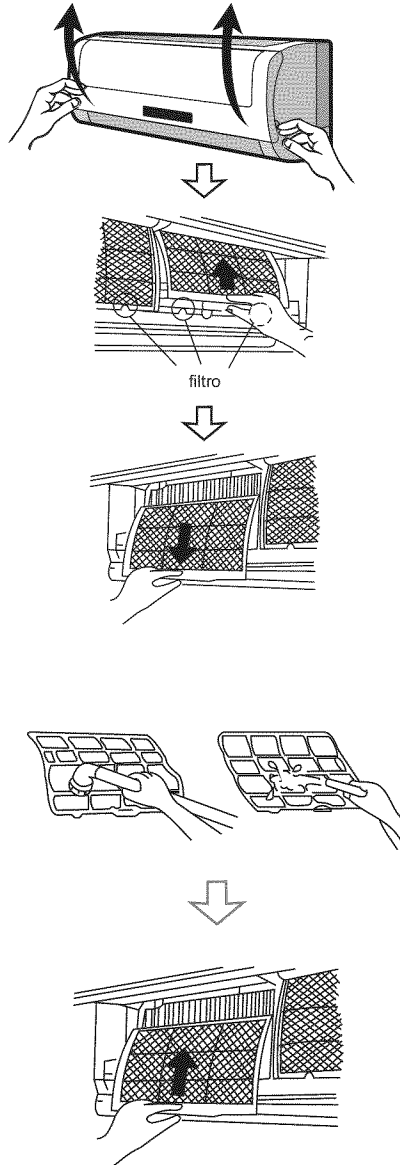

Cleaning the indoor unit and remote controller

1. Use a dry cloth to wipe the indoor unit and remote controller.
2. A cloth dampened with cold water may be used on the indoor unit if it is very dirty.
3. The front panel of the indoor unit can be removed and cleaned with water. Then wipe it with a dry cloth.
4. Do not use a chemically treated cloth or duster to clean the unit.
6. Do not use benzine, thinner, polishing powder, or similar solvents for cleaning. These may cause the plastic surface to crack or deform.

If you plan to idle the unit for a long time

1. Operate the fan for about half a day to dry the inside of the unit.
2. Stop the air conditioner and disconnect power.
Remove the batteries from the remote controller.
3. The outdoor unit requires periodic maintenance and cleaning. Do not attempt to do this yourself. Contact your dealer or servicer.

Checks before operation

1. Check that the wiring is not broken off or disconnected.
2. Check that the air filter is installed.
3. Check if the air outlet or inlet is blocked after the air conditioner has not been used for a long time.

Important

It is necessary to stop the air conditioner and disconnect the power supply before cleaning.

Important

- Do not touch the metal parts of the unit when removing the filter. Injuries can occur when handling sharp metal edges.
- Do not use water to clean inside the air conditioner.
Exposure to water can destroy the insulation, leading to possible electric shock.
- When cleaning the unit, first make sure that the power and circuit breaker are turned off.

Operation tips

The following events may occur during normal operation:

Protection of the air conditioner

Compressor protection:

The compressor can't restart for 3 minutes after it stops.

Anti-cold air (Cooling and heating models only):

The unit is designed not to blow cold air on HEAT mode, when the indoor heat exchanger is in one of the following three situations and the set temperature has not been reached.

1. When heating has just starting.
2. Defrosting.
3. Low temperature heating.

Defrosting (Cooling and heating models only):

Frost may be generated on the outdoor unit during heat cycle when outdoor temperature is low and humidity is high resulting in lower heating efficiency of the air conditioner.

During this condition air conditioner will stop heating operation and start defrosting automatically.

The time to defrost may vary from 4 to 10 minutes according to the outdoor temperature and the amount of frost buildup on the outdoor unit.

The indoor or outdoor fan stop running when defrosting (Cooling and heating models only).

A white mist coming out from the indoor unit

A white mist may generate due to a large temperature difference between air inlet and air outlet on COOL mode in an indoor environment that has a high relative humidity.

A white mist may generate due to moisture generated from defrosting process when the air conditioner restarts in HEAT mode operation after defrosting.

Low noise of the air conditioner

You may hear a low hissing sound when the compressor is running or has just stopped running. This sound is the sound of the refrigerant flowing or coming to a stop.

You can also hear a low "squeak" sound when the compressor is running or has just stopped running. This is caused by heat expansion and cold contraction of the plastic parts in the unit when the temperature is changing.

A noise may be heard due to louver restoring to its original position when power is first turned on.

Dust is blown out from the indoor unit

This is a normal condition when the air conditioner has not been used for a long time or during first use of the unit.

A peculiar smell comes out from the indoor unit

This is caused by the indoor unit giving off smells permeated from building material, from furniture, or smoke.

Dripping water may generate on the surface of the indoor unit when cooling in a high relatively humidity (relative humidity higher than 80%)

Adjust the horizontal louver to the maximum air outlet position and select HIGH fan speed.

The air conditioner turns to FAN only mode from COOL or HEAT (For cooling and heating models only) mode

When indoor temperature reaches the temperature setting on air conditioner, the compressor will stop automatically, and the air conditioner turns to FAN only mode. The compressor will start again when the indoor temperature rises on COOL mode or falls on HEAT mode (For cooling and heating models only) to the set point.

Heating mode (For cooling and heating models only)

The air conditioner draws in heat from the outdoor unit and releases it via the indoor unit during heating operation. When the outdoor temperature falls, heat drawn in by the air conditioner decreases accordingly. At the same time, heat loading of the air conditioner increases due to larger difference between indoor and outdoor temperature. If a comfortable temperature can't be achieved by the air conditioner, we suggest you use a supplementary heating device.

Auto-restart function

Power failure during operation will stop the unit completely. For the unit without Auto-restart feature, when the power restores, the OPERATION indicator on the indoor unit starts flashing. To restart the operation, push the ON/OFF button on the remote controller. For the unit with Auto-restart feature, when the power restores, the unit restarts automatically with all the previous settings preserved by the memory function.

Lightning or a car wireless telephone operating nearby may cause the unit to malfunction

Disconnect the unit with power and then re-connect the unit with power again. Push the ON/OFF button on the remote controller to restart operation.

Troubleshooting tips

Malfunctions and solutions

Stop the air conditioner immediately if one of the following faults occur. Disconnect the power and contact the nearest customer service center.

Trouble	OPERATION indicator or other indicators flash rapidly (5 times every second) and this flash can't be fixed by disconnecting the power, and then connect it in again.
	Fuse blows frequently or circuit breaker trips frequently.
	Other objects or water penetrate in the air conditioner.
	The remote control won't work or works abnormally.
	Other abnormal situations.

Malfunctions	Cause	What should be done?
Unit does not start	Power cut	Wait for power to be restored.
	Unit may have become unplugged.	Check that plug is securely in wall receptacle.
	Fuse may have blown.	Replace the fuse.
	Battery in Remote controller may have been exhausted.	Replace the battery.
	The time you have set with timer is incorrect.	Wait or cancel timer setting.
Unit not cooling or heating (Cooling/heating models only) room very well while air flowing out from the air conditioner	Inappropriate temperature setting	Set temperature correctly. For detailed method please refer to "Using remote control" section.
	Air filter is blocked.	Clean the air filter.
	Doors or Windows are open.	Close the doors or windows.
	Air inlet or outlet of indoor or outdoor unit has been blocked.	Clear obstructions away first, then restart the unit.
	Compressor 3 minutes protection has been activated.	Wait.

If the trouble has not been corrected, please contact a local dealer or the nearest customer service center. Be sure to inform them of the detailed malfunctions and unit model.

Notes: Do not attempt to repair the unit yourself. Always consult an authorised service provider.

Environmental advices

The packaging material used is recyclable; we recommend that you separate plastic, paper and cardboard and give them to recycling companies.

According to WEEE (Waste of Electrical and Electronic Equipment) guidelines, waste from electrical and electronic devices should be collected separately. If you need to dispose of this appliance in the future, do NOT throw it away with the rest of your domestic garbage. Instead, please take the appliance to the nearest WEEE collection point, where available.

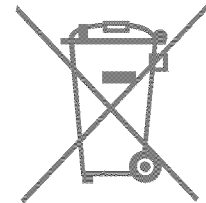

Technical informations

Cooling only type

OUTDOOR UNIT	FSC09CH8M	FSC12CH8M	FSC18CH8M	FSC24CH8M
INDOOR UNIT	FSE09CH8M	FSE12CH8M	FSE18CH8M	FSE24CH8M
Cycle	Cool	Cool	Cool	Cool
Cooling power (Btu/h)	9000	12000	18000	24000
Rated Voltage (V)	220-230~	220-230~	220-230~	220-230~
Frequency (Hz)	60	60	60	60
Indoor unit high (mm)	275	275	275	313
Indoor unit width (mm)	790	790	928	1030
Indoor unit depth (mm)	190	190	198	221
Indoor unit net weight (kg)	8,5	9	10	14,5
Outdoor unit high (mm)	430	535	540	695
Outdoor unit width (mm)	685	700	780	845
Outdoor unit depth (mm)	260	235	250	335
Outdoor unit net weight (kg)	24	27	34	56

Heating + cooling type

OUTDOOR UNIT	FSC09PH8M	FSC12PH8M	FSC18PH8M	FSC24PH8M
INDOOR UNIT	FSE09PH8M	FSE12PH8M	FSE18PH8M	FSE24PH8M
Cycle	Cool/heat	Cool/heat	Cool/heat	Cool/heat
Cooling power (Btu/h)	9000	12000	18000	24000
Heating power (Btu/h)	9000	14000	20000	28000
Rated Voltage (V)	220-230~	220-230~	220-230~	220-230~
Frequency (Hz)	60	60	60	60
Indoor unit high(mm)	275	275	275	313
Indoor unit width (mm)	790	790	928	1030
Indoor unit depth (mm)	190	190	198	221
Indoor unit net weight (kg)	8,5	9	10	14,5
Outdoor unit high (mm)	430	535	540	695
Outdoor unit width (mm)	685	700	780	845
Outdoor unit depth (mm)	260	235	250	335
Outdoor unit net weight (kg)	24	28	35	57

Cooling only type

OUTDOOR UNIT	FSC09CH7M	FSC12CH7M	FSC18CH7M	FSC24CH7M
INDOOR UNIT	FSE09CH7M	FSE12CH7M	FSE18CH7M	FSE24CH7M
Cycle	Cool	Cool	Cool	Cool
Cooling power (Btu/h)	9000	12000	18000	24000
Rated Voltage (V)	220-240~	220-240~	220-240~	220-240~
Frequency (Hz)	50	50	50	50
Indoor unit high (mm)	190	190	198	313
Indoor unit width (mm)	790	790	928	1030
Indoor unit depth (mm)	275	275	275	221
Indoor unit net weight (kg)	8,5	9	11	14,5
Outdoor unit high (mm)	430	535	540	695
Outdoor unit width (mm)	685	700	780	845
Outdoor unit depth (mm)	260	235	250	335
Outdoor unit net weight (kg)	24	29	34	56

Heating + cooling type

OUTDOOR UNIT	FSC09PH7M	FSC12PH7M	FSC18PH7M	FSC24PH7M
INDOOR UNIT	FSE09PH7M	FSE12PH7M	FSE18PH7M	FSE24PH7M
Cycle	Cool/heat	Cool/heat	Cool/heat	Cool/heat
Cooling power (Btu/h)	9000	12000	18000	24000
Heating power (Btu/h)	9000	14000	20000	28000
Rated Voltage (V)	220-240~	220-240~	220-240~	220-240~
Frequency (Hz)	50	50	50	50
Indoor unit high(mm)	190	190	198	1313
Indoor unit width (mm)	790	790	928	1030
Indoor unit depth (mm)	275	275	275	221
Indoor unit net weight (kg)	8,5	9	11	14,5
Outdoor unit high (mm)	430	535	540	695
Outdoor unit width (mm)	685	700	780	845
Outdoor unit depth (mm)	260	235	250	335
Outdoor unit net weight (kg)	24	30	40	59

 **The Electrolux Group.**

The Electrolux Group is the world's largest producer of powered appliances for kitchen, cleaning and outdoor use. More than 55 million Electrolux Group products (such as refrigerators, cookers, washing machines, vacuum cleaners, chain saws and lawn mowers) are sold each year to a value of approx. USD 14 billion in more than 150 countries around the world.

Frigidaire

S1138-145JFM - split M Model_080904Y

Free Manuals Download Website

<http://myh66.com>

<http://usermanuals.us>

<http://www.somanuals.com>

<http://www.4manuals.cc>

<http://www.manual-lib.com>

<http://www.404manual.com>

<http://www.luxmanual.com>

<http://aubethermostatmanual.com>

Golf course search by state

<http://golfingnear.com>

Email search by domain

<http://emailbydomain.com>

Auto manuals search

<http://auto.somanuals.com>

TV manuals search

<http://tv.somanuals.com>