

# FUJIFILM

BL01292-200 **EN**

DIGITAL CAMERA

## FINEPIX HS20EXR

### Owner's Manual

Thank you for your purchase of this product. This manual describes how to use your FUJIFILM FinePix HS20EXR digital camera and the supplied software. Be sure that you have read and understood its contents before using the camera.

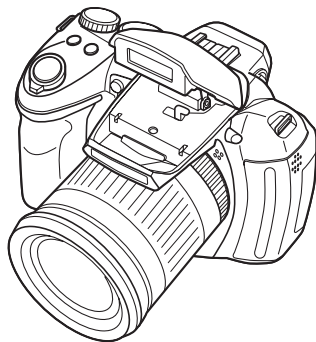

For information on related products, visit our website at [http://www.fujifilm.com/products/digital\\_cameras/index.html](http://www.fujifilm.com/products/digital_cameras/index.html)

**Before You Begin**

**First Steps**

**Basic Photography and Playback**

**More on Photography**

**More on Playback**

**Movies**

**Connections**

**Menus**

**Technical Notes**

**Troubleshooting**

**Appendix**



## IMPORTANT SAFETY INSTRUCTIONS

- **Read Instructions:** All the safety and operating instructions should be read before the appliance is operated.
- **Retain Instructions:** The safety and operating instructions should be retained for future reference.
- **Heed Warnings:** All warnings on the appliance and in the operating instructions should be adhered to.
- **Follow Instructions:** All operating and use instructions should be followed.

### Installation

**Power Sources:** This video product should be operated only from the type of power source indicated on the marking label. If you are not sure of the type of power supply to your home, consult your appliance dealer or local power company. For video products intended to operate from battery power, or other sources, refer to the operating instructions.

**Grounding or Polarization:** This video product is equipped with a polarized alternating-current line plug (a plug having one blade wider than the other). This plug will fit into the power outlet only one way. This is a safety feature. If you are unable to insert the plug fully into the outlet, try reversing the plug. If the plug should still fail to fit, contact your electrician to replace your obsolete outlet. Do

not defeat the safety purpose of the polarized plug.

**Alternate Warnings:** This video product is equipped with a 3-wire grounding-type plug, a plug having a third (grounding) pin. This plug will only fit into a grounding-type power outlet. This is a safety feature. If you are unable to insert the plug into the outlet, contact your electrician to replace your obsolete outlet. Do not defeat the safety purpose of the grounding-type plug.

**Overloading:** Do not overload wall outlets and extension cords as this can result in a risk of fire or electric shock.

**Ventilation:** Slots and openings in the cabinet are provided for ventilation and to ensure reliable operation of the video product and to protect it from overheating, and these openings must not be blocked or covered.

The openings should never be blocked by placing the video product on a bed, sofa, rug, or other similar surface.

This video product should not be placed in a built-in installation such as a bookcase or rack unless proper ventilation is provided or the manufacturer's instructions have been adhered to.

This video product should never be placed near or over a radiator or heat register.

**Attachments:** Do not use attachments not recommended by the video product manufacturer as they may cause hazards.

**Water and Moisture:** Do not use this video product near water – for example, near a bath tub, wash bowl, kitchen sink, or laundry tub, in a wet basement, or near a swimming pool, and the like.

**Power-Cord Protection:** Power-Supply cords should be routed so that they are not likely to be walked on or pinched by items placed upon or against them, paying particular attention to cords at plugs, convenience receptacles, and the point where they exit from the appliance.

**Accessories:** Do not place this video product on an unstable cart, stand, tripod, bracket, or table. The video product may fall, causing serious injury to a child or adult, and serious damage to the appliance. Use only with a cart, stand, tripod, bracket, or table recommended by the manufacturer, or sold with the video product. Any mounting of the appliance should follow the manufacturer's instructions, and should use a mounting accessory recommended by the manufacturer.

An appliance and cart combination should be moved with care. Quick stops, excessive force, and uneven surfaces may cause the appliance and cart combination to overturn.



### Antennas

**Outdoor Antenna Grounding:** If an outside antenna or cable system is connected to the video product, be sure the antenna or cable system is grounded so as to provide some protection against voltage surges and built-up static charges. Section 810 of the National Electrical Code, ANSI/NFPA No. 70, provides information with respect to proper grounding of the mast and supporting structure, grounding of the lead-in wire to an antenna-discharge unit, size of grounding conductors, location of antenna-discharge unit, connection to grounding electrodes, and requirements for the grounding electrode.

**Power Lines:** An outside antenna system should not be located in the vicinity of overhead power lines or other electric light or power circuits, or where it can fall into such power lines or circuits. When installing an outside antenna system, extreme care should be taken to keep from touching such power lines or circuits as contact with them might be fatal.

*EXAMPLE OF ANTENNA GROUNDING AS PER NATIONAL ELECTRICAL CODE*

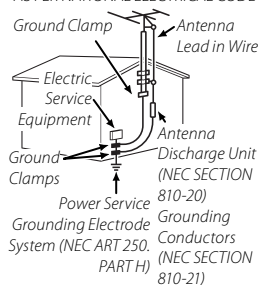

**Use**

**Cleaning:** Unplug this video product from the wall outlet before cleaning. Do not use liquid cleaners or aerosol cleaners. Use a damp cloth for cleaning.

**Object and Liquid Entry:** Never push objects of any kind into this video product through openings as they may touch dangerous voltage points or short out parts that could result in a fire or electric shock. Never spill liquid of any kind on the video product.

**Lightning:** For added protection for this video product receiver during a lightning storm, or when it is left unattended and unused for long periods of time, unplug it from the wall outlet and disconnect the antenna or cable system. This will prevent damage to the video product due to lightning and power-line surges.

**Service**

**Service:** Do not attempt to service this video product yourself as opening or removing covers may expose you to dangerous voltage or other hazards. Refer all servicing to qualified service personnel.

**Damage Requiring Service:** Unplug this video product from the wall outlet and refer servicing to qualified service personnel under the following conditions:

When the power-supply cord or plug is damaged.

If liquid has been spilled, or objects have fallen into the video product.

If the video product has been exposed to rain or water.

If the video product has been dropped or the cabinet has been damaged.

If the video product does not operate normally be following the operating instructions. Adjust only those controls that are covered by the operating instructions as an improper adjustment of other controls may result in damage and will often require extensive work by a qualified technician to restore the video product to its normal operation.

When the video product exhibits a distinct change in performance - this indicates a need for service.

**Replacement Parts:** When replacement parts are required, be sure the service technician has used replacement parts specified by the manufacturer or have the same characteristics as the original part. Unauthorized substitutions may result in fire, electric shock or other hazards.

**Safety Check:** Upon completion of any service or repairs to this video product, ask the service technician to perform safety checks to determine that the video product is in proper operating condition.



## Be sure to read this notes before using

### Safety Notes



- Make sure that you use your camera correctly. Read these Safety Notes and your *Owner's Manual* carefully before use.
- After reading these Safety Notes, store them in a safe place.

### About the Icons

The icons shown below are used in this document to indicate the severity of the injury or damage that can result if the information indicated by the icon is ignored and the product is used incorrectly as a result.

	<b>WARNING</b>	This icon indicates that death or serious injury can result if the information is ignored.
	<b>CAUTION</b>	This icon indicates that personal injury or material damage can result if the information is ignored.









The icons shown below are used to indicate the nature of the information which is to be observed.

	Triangular icons tell you that this information requires attention ("important").
	Circular icons with a diagonal bar tell you that the action indicated is prohibited ("Prohibited").
	Filled circles with an exclamation mark tell you an action that must be performed ("Required").

### WARNING

	<b>If a problem arises, turn the camera off, remove the battery, disconnect and unplug the AC power adapter.</b> Continued use of the camera when it is emitting smoke, is emitting any unusual odor, or is in any other abnormal state can cause a fire or electric shock. • Contact your FUJIFILM dealer.
--	---

### WARNING

	<b>Do not allow water or foreign objects to enter the camera.</b> If water or foreign objects get inside the camera, turn the camera off, remove the battery and disconnect and unplug the AC power adapter. Continued use of the camera can cause a fire or electric shock. • Contact your FUJIFILM dealer.
	<b>Do not use the camera in the bathroom or shower.</b> This can cause a fire or electric shock.
	<b>Never attempt to disassemble or modify (never open the case).</b> Failure to observe this precaution can cause fire or electric shock.
	<b>Should the case break open as the result of a fall or other accident, do not touch the exposed parts.</b> Failure to observe this precaution could result in electric shock or injury from touching the damaged parts. Remove the battery immediately, taking care to avoid injury or electric shock, and take the product to the point of purchase for consultation.
	<b>Do not change, heat or unduly twist or pull the connection cord and do not place heavy objects on the connection cord.</b> These actions could damage the cord and cause a fire or electric shock. • If the cord is damaged, contact your FUJIFILM dealer.
	<b>Do not place the camera on an unstable surface.</b> This can cause the camera to fall or tip over and cause injury.
	<b>Never attempt to take pictures while in motion.</b> Do not use the camera while you are walking or driving a vehicle. This can result in you falling down or being involved in a traffic accident.
	<b>Do not touch any metal parts of the camera during a thunderstorm.</b> This can cause an electric shock due to induced current from the lightning discharge.
	<b>Do not use the battery except as specified.</b> Load the battery as aligned with the indicator.

**! WARNING**

**Do not heat, charge or take apart the battery. Do not drop or subject the battery to impacts. Do not store the battery with metallic products. Do not use chargers other than the specified model to charge the battery.**

Any of these actions can cause the battery to burst or leak and cause fire or injury as a result.



**Use only the battery or AC power adapters specified for use with this camera. Do not use voltages other than the power supply voltage shown.**

The use of other power sources can cause a fire.



**If the battery leaks and fluid gets in contact with your eyes, skin or clothing. Flush the affected area with clean water and seek medical attention or call an emergency number right away.**



**Do not use the charger to charge batteries other than those specified here.**

The Ni-MH battery charger is designed for FUJIFILM HR-AA Ni-MH batteries. Using the charger to charge conventional batteries or other types of rechargeable batteries can cause the battery to leak fluid, overheat or burst.



**When carrying the battery, install it in a digital camera or keep it in the hard case. When storing the battery, keep it in the hard case. When discarding, cover the battery terminals with insulation tape.**

Contact with other metallic objects or battery could cause the battery to ignite or burst.



**Keep Memory Cards out of the reach of small children.**

Because Memory Cards are small, they can be swallowed by children. Be sure to store Memory Cards out of the reach of small children. If a child swallows a Memory Card, seek medical attention or call an emergency number.

**! CAUTION**

**Do not use this camera in locations affected by oil fumes, steam, humidity or dust.**

This can cause a fire or electric shock.



**Do not leave this camera in places subject to extremely high temperatures.**

Do not leave the camera in locations such as a sealed vehicle or in direct sunlight. This can cause a fire.



**Keep out of the reach of small children.**

This product could cause injury in the hands of a child.

**! CAUTION**

**Do not place heavy objects on the camera.**

This can cause the heavy object to tip over or fall and cause injury.



**Do not move the camera while the AC power adapter is still connected. Do not pull on the connection cord to disconnect the AC power adapter.**

This can damage the power cord or cables and cause a fire or electric shock.



**Do not use the AC power adapter when the plug is damaged or the plug socket connection is loose.**

This could cause a fire or electric shock.



**Do not cover or wrap the camera or the AC power adapter in a cloth or blanket.**

This can cause heat to build up and distort the casing or cause a fire.



**When you are cleaning the camera or you do not plan to use the camera for an extended period, remove the battery and disconnect and unplug the AC power adapter.**

Failure to do so can cause a fire or electric shock.



**When charging ends, unplug the charger from the power socket.**

Leaving the charger plugged into the power socket can cause a fire.



**Using a flash too close to a person's eyes may temporarily affect the eyesight.**

Take particular care when photographing infants and young children.



**When a memory card is removed, the card could come out of the slot too quickly. Use your finger to hold it and gently release the card.**



**Request regular internal testing and cleaning for your camera.**

Build-up of dust in your camera can cause a fire or electric shock.

- Contact your FUJIFILM dealer to request internal cleaning every 2 years.

- Please note this is not a free of charge service.

### Power Supply and Battery

\* Confirm your battery type before reading the following descriptions.

The following explains proper use of batteries and how to prolong their life. Incorrect use of batteries can cause shorter battery life, as well as leakage, excessive heat, fire or explosion.

#### 1 Camera uses the Rechargeable Lithium-ion Battery

- \* When shipped, the battery is not fully charged. Always charge the battery before using it.
- \* When carrying the battery, install it in a digital camera or keep it in the soft case.

#### ■ Battery Features

- The battery gradually loses its charge even when not used. Use a battery that has been charged recently (in the last day or two) to take pictures.
- To maximize the life of the battery, turn the camera off as quickly as possible when it is not being used.
- The number of available frames will be lower in cold locations or at low temperatures. Take along a spare fully charged battery. You can also increase the amount of power produced by putting the battery in your pocket or another warm place to heat it and then loading it into the camera just before you take a picture.

If you are using a heating pad, take care not to place the battery directly against the pad. The camera may not operate if you use a depleted battery in cold conditions.

#### ■ Charging the Battery

- You can charge the battery using the battery charger (included).
  - The battery can be charged at ambient temperatures between 0°C and +40°C (+32°F and +104°F). Refer to the *Owner's Manual* for the time of charging battery.
  - You should charge the battery at an ambient temperature between +10°C and +35°C (+50°F and +95°F). If you charge the battery at a temperature outside this range, charging takes longer because the performance of the battery is impaired.
  - You cannot charge the battery at temperatures of 0°C (+32°F) or below.
- The Rechargeable Lithium-ion Battery does not need to be fully discharged or exhausted flat before being charged.
- The battery may feel warm after it has been charged or immediately after being used. This is perfectly normal.
- Do not recharge a fully charged battery.

#### ■ Battery Life

At normal temperatures, the battery can be used at least 300 times. If the time for which the battery provides power shortens markedly, this indicates that the battery has reached the end of its effective life and should be replaced.

#### ■ Notes on storage

- If a battery is stored for long periods while charged, the performance of the battery can be impaired. If the battery will not be used for some time, run the battery out before storing it.
- If you do not intend to use the camera for a long period of time, remove the battery from the camera.
- Store the battery in a cool place.
  - The battery should be stored in a dry location with an ambient temperature between +15°C and +25°C (+59°F and +77°F).
  - Do not leave the battery in hot or extremely cold places.

#### ■ Handling the Battery Cautions for Your Safety:

- Do not carry or store battery with metal objects such as necklaces or hairpins.
- Do not heat the battery or throw it into a fire.
- Do not attempt to take apart or change the battery.
- Do not recharge the battery with chargers other than those specified.

- Dispose of used battery promptly.
- Do not drop the battery or otherwise subject it to strong impacts.
- Do not expose the battery to water.
- Always keep the battery terminals clean.
- Do not store batteries in hot places. Also, if you use the battery for a long period, the camera body and the battery itself will become warm. This is normal. Use the AC power adapter if you are taking pictures or viewing images for a long period of time.

#### 2 Camera uses AA-size alkaline or Ni-MH (nickel-metal hydride) rechargeable batteries

\* For details on the batteries that you can use, refer to the *Owner's Manual* of your camera.

#### ■ Cautions for Using Battery

- Do not heat the batteries or throw them into a fire.
- Do not carry or store batteries with metal objects such as necklaces or hairpins.
- Do not expose the batteries to water, and keep batteries from getting wet or stored in moist locations.
- Do not attempt to take apart or change the batteries, including battery casings.
- Do not subject the batteries to strong impacts.
- Do not use batteries that are leaking, deformed, discolored.

- Do not store batteries in warm or humid places.
- Keep the batteries out of reach of babies and small children.
- Make sure that the battery polarity (⊕ and ⊖) is correct.
- Do not use new with used batteries. Do not use charged and discharged batteries together.
- Do not use different types or brands of batteries at the same time.
- If you do not intend to use the camera for a long period of time, remove the batteries from the camera. Note if the camera is left with the batteries removed, the time and date settings are cleared.
- The batteries feel warm right after being used. Before removing the batteries, turn the camera off and wait for the batteries to cool down.
- Since batteries do not work well in cold weather or locations, warm the batteries by placing them inside your garments before use. Batteries do not work well when cold. They will work again when the temperature returns to normal.
- Soil (such as fingerprints) on the battery terminals makes the batteries charge less reducing the number of images. Carefully wipe the battery terminals with a soft dry cloth before loading.



If any liquid at all leaks from the batteries, wipe the battery compartment thoroughly and then load new batteries.



If any battery fluid comes into contact with your hands or clothing, flush the area thoroughly with water. Note that battery fluid can cause loss of eyesight if it gets into your eyes. If this occurs, do not rub your eyes. Flush the fluid out with clean water and contact your physician for treatment.

#### ■ Using the AA-size Ni-MH batteries correctly

- Ni-MH batteries left unused in storage for long periods can become “deactivated”. Also, repeatedly charging Ni-MH batteries that are only partially discharged can cause them to suffer from the “memory effect”. Ni-MH batteries that are “deactivated” or affected by “memory” suffer from the problem of only providing power for a short time after being charged. To prevent this problem, discharge and recharge them several times using the camera’s “Discharging rechargeable batteries” function. Deactivation and memory are specific to Ni-MH batteries and are not in fact battery faults.

See *Owner’s Manual* for the procedure for “Discharging rechargeable batteries”.

#### ⚠ CAUTION

Do not use the “Discharging rechargeable batteries” function when alkaline batteries being used.

- To charge Ni-MH batteries, use the quick battery charger (sold separately). Refer to the instructions supplied with the charger to make sure that the charger is used correctly.
- Do not use the battery charger to charge other batteries.
- Note that the batteries feel warm after being charged.
- Due to the way the camera is constructed, a small amount of current is used even when the camera is turned off. Note in particular that leaving Ni-MH batteries in the camera for a long period will over-discharge the batteries and may render them unusable even after recharging.
- Ni-MH batteries will self-discharge even when not used, and the time for which they can be used may be shortened as a result.
- Ni-MH batteries will deteriorate rapidly if over-discharged (e.g. by discharging the batteries in a flashlight). Use the “Discharging rechargeable batteries” function provided in the camera to discharge the batteries.

- Ni-MH batteries have a limited service life. If a battery can only be used for a short time even after repeated discharge-charge cycles, it may have reached the end of its service life.

#### ■ Disposing of Batteries

- When disposing of batteries, do so in accordance with your local waste disposal regulations.

#### 3 Notes on both models (1 2)

##### ■ AC Power Adapter

Always use the AC Power Adapter with the camera. The use of an AC Power adapter other than FUJIFILM AC Power Adapter can be damaged to your digital camera.

For details on the AC power adapter, refer to the *Owner’s Manual* of your camera.

- Use the AC power adapter for indoor use only.
- Plug the connection cord plug securely into the DC input terminal.
- Turn off the FUJIFILM Digital camera before disconnecting the cord from the DC input terminal. To disconnect, pull out the plug gently. Do not pull on the cord.
- Do not use the AC power adapter with any device other than your camera.
- During use, the AC power adapter will become hot to the touch. This is normal.

- Do not take apart the AC power adapter. Doing so could be dangerous.
- Do not use the AC power adapter in a hot and humid place.
- Do not subject the AC power adapter to strong shocks.
- The AC power adapter may emit a humming. This is normal.
- If used near a radio, the AC power adapter may cause static. If this happens, move the camera away from the radio.

#### Before Using the Camera

Do not aim the camera at extremely bright light sources, such as the sun in a cloudless sky. Failure to observe this precaution could damage the camera image sensor.

#### ■ Test Shots Prior to Photography

For important photographs (such as weddings and overseas trips), always take a test shot and view the image to make sure that the camera is working normally.

- FUJIFILM Corporation cannot accept liability for any incidental losses (such as the costs of photography or the loss of income from photography) incurred as a result of faults with this product.

#### ■ Notes on Copyright

Images recorded using your digital camera system cannot be used in ways that infringe copyright laws without the consent of the owner,

unless intended only for personal use. Note that some restrictions apply to the photographing of stage performances, entertainments and exhibits, even when intended purely for personal use. Users are also asked to note that the transfer of Memory Card containing images or data protected under copyright laws is only permissible within the restrictions imposed by those copyright laws.

#### ■ Handling Your Digital Camera

To ensure that images are recorded correctly, do not subject the camera to impact or shock while an image is being recorded.

#### ■ Liquid Crystal

If the LCD monitor is damaged, take particular care with the liquid crystal in the monitor. If any of the following situations arise, take the urgent action indicated.

- If liquid crystal comes in contact with your skin:  
Wipe the area with a cloth and then wash thoroughly with soap and running water.
- If liquid crystal gets into your eye:  
Flush the affected eye with clean water for at least 15 minutes and then seek medical assistance.
- If liquid crystal is swallowed:  
Flush your mouth thoroughly with water. Drink large quantities of water and induce vomiting. Then seek medical assistance.

Although the LCD panel is produced with highly sophisticated technologies, there may be black spots or permanently lit spots. This is not a malfunction, and does not affect recorded images.

#### ■ Trademark Information

*xD-Picture Card* and  are trademarks of FUJIFILM Corporation. The typefaces included herein are solely developed by DynaComware Taiwan Inc. Macintosh, QuickTime, and Mac OS are trademarks of Apple Inc. in the U.S.A. and other countries. Windows 7, Windows Vista, and the Windows logo are trademarks of the Microsoft group of companies. Adobe and Adobe Reader are either trademarks or registered trademarks of Adobe Systems Incorporated in the U.S.A. and/or other countries. The SDHC and SDXC logos are trademarks of SD-3C, LLC. The HDMI logo is a trademark. YouTube is a trademark of Google Inc. All other trade names mentioned in this manual are the trademarks or registered trademarks of their respective owners.

#### ■ Notes on Electrical Interference

If the camera is to be used in hospitals or aircrafts, please note that this camera may cause interference to other equipment in the hospital or aircraft. For details, please check with the applicable regulations.

#### ■ Explanation of Color Television System

NTSC: National Television System Committee, color television telecasting specifications adopted mainly in the U.S.A., Canada and Japan.

PAL: Phase Alternation by Line, a color television system adopted mainly by European countries and China.

#### ■ Exif Print (Exif ver. 2.3)

Exif Print Format is a newly revised digital camera file format that contains a variety of shooting information for optimal printing.

#### IMPORTANT NOTICE: Read Before Using the Software

Direct or indirect export, in whole or in part, of licensed software without the permission of the applicable governing bodies is prohibited.



# About This Manual

Before using the camera, read this manual and the warnings on pages ii–viii. For information on specific topics, consult the sources below.

## ✓ **Table of Contents** ..... **x**

The “Table of Contents” gives an overview of the entire manual. The principal camera operations are listed here.

## ✓ **Troubleshooting** ..... **102**

Having a specific problem with the camera? Find the answer here.

## ✓ **Warning Messages and Displays** ..... **109**

Find out what’s behind that flashing icon or error message in the display.

### **Temperature Warning**

The camera will turn off automatically before its temperature or the temperature of the battery rise above safe limits. Pictures taken when a temperature warning is displayed may exhibit higher levels of “noise” (mottling). Turn the camera off and wait for it to cool before turning it on again ( 105, 110).

# Table of Contents



For Your Safety .....	ii	A: APERTURE PRIORITY AE.....	29
IMPORTANT SAFETY INSTRUCTIONS.....	ii	M: MANUAL .....	30
Safety Notes.....	iv	C: CUSTOM MODE.....	30
About This Manual.....	ix	Focus Lock .....	31
<b>Before You Begin</b>		The AE/AF LOCK Button .....	32
Introduction.....	1	Locking Exposure.....	32
Symbols and Conventions.....	1	Locking Focus.....	32
Supplied Accessories.....	1	👉 Macro and Super Macro Modes (Close-ups) .....	33
Parts of the Camera.....	2	🔦 Using the Flash (Super-Intelligent Flash) .....	34
Camera Displays .....	5	🕒 Using the Self-Timer.....	36
<b>First Steps</b>		📷 Exposure Compensation.....	37
The Strap and Lens Cap .....	7	Sensitivity .....	38
Inserting the Batteries .....	8	Metering .....	39
Inserting a Memory Card.....	10	Autofocus Mode.....	40
Turning the Camera on and Off .....	13	Focus Mode .....	41
Basic Setup .....	14	White Balance .....	43
<b>Basic Photography and Playback</b>		📷 Continuous Shooting (Burst Mode).....	44
Taking Pictures in  (EXR AUTO) Mode.....	15	👤 Intelligent Face Detection.....	48
Viewing Pictures .....	20	👤 Face Recognition .....	49
<b>More on Photography</b>		Adding New Faces .....	49
Shooting Mode.....	21	Viewing, Editing, and Deleting Existing Data.....	50
 (EXR AUTO/EXR Priority) .....	22	Adding Faces Automatically.....	50
📷 AUTO .....	23	<b>More on Playback</b>	
Adv. ADVANCED.....	23	Playback Options.....	52
SP1/SP2 SCENE POSITION .....	25	Continuous Shooting .....	52
 MOTION PANORAMA 360 .....	27	★ Favorites: Rating Pictures .....	52
P: PROGRAM AE .....	28	Playback Zoom.....	53
S: SHUTTER PRIORITY AE.....	29	Multi-Frame Playback.....	54
		🗑️ Deleting Pictures .....	55
		Viewing Photo Information .....	56

Image Search.....	57	IMAGE SIZE.....	78
PhotoBook Assist.....	58	IMAGE QUALITY.....	79
Creating a PhotoBook.....	58	DYNAMIC RANGE.....	80
Viewing PhotoBooks.....	59	FILM SIMULATION.....	80
Editing and Deleting PhotoBooks.....	59	WB SHIFT.....	81
Viewing Panoramas.....	60	COLOR.....	81
<b>Movies</b>		TONE.....	81
Recording Movies.....	61	SHARPNESS.....	81
Movie Frame Size.....	62	NOISE REDUCTION.....	81
Viewing Movies.....	63	ADVANCED ANTI BLUR.....	81
<b>Connections</b>		FACE DETECTION.....	81
Viewing Pictures on TV.....	64	FACE RECOGNITION.....	81
Printing Pictures via USB.....	66	MOVIE AF MODE.....	82
Connecting the Camera.....	66	MOVIE MODE.....	82
Printing Selected Pictures.....	66	AE BKT EV STEPS.....	82
Printing the DPOF Print Order.....	67	FLASH.....	82
Printing the DPOF Print Order.....	67	EXTERNAL FLASH.....	83
Creating a DPOF Print Order.....	69	CUSTOM SET.....	83
Viewing Pictures on a Computer.....	72	ELECTRONIC LEVEL.....	83
Installing the Software.....	72	<b>Using the Menus: Playback Mode.....</b>	84
Connecting the Camera.....	76	Using the Playback Menu.....	84
<b>Menus</b>		Playback Menu Options.....	84
Using the Menus: Shooting Mode.....	78	PHOTOBOOK ASSIST.....	84
Using the Shooting Menu.....	78	ERASE.....	84
Shooting Menu Options.....	78	MARK FOR UPLOAD TO.....	84
<b>EXR</b> MODE.....	78	SLIDE SHOW.....	85
<b>Adv.</b> MODE.....	78	RED EYE REMOVAL.....	86
SCENE POSITION.....	78	PROTECT.....	86
ISO.....	78	CROP.....	87
		RESIZE.....	87
		IMAGE ROTATE.....	88

COPY.....	88	SAVE ORG IMAGE.....	97
VOICE MEMO.....	89	AUTOROTATE PB.....	97
ERASE FACE RECOG. ....	89	BACKGROUND COLOR.....	97
PRINT ORDER (DPOF).....	89	GUIDANCE DISPLAY.....	97
DISP. ASPECT.....	90	VIDEO SYSTEM.....	97
<b>The Setup Menu</b> .....	91	CUSTOM RESET.....	98
Using the Setup Menu.....	91	BATTERY TYPE.....	98
Setup Menu Options.....	92	DISCHARGE (Ni-MH Batteries Only) .....	98
DATE/TIME.....	92		
TIME DIFFERENCE.....	92		
言語/LANG.....	92		
SILENT MODE.....	92		
RESET.....	93		
FORMAT.....	93		
IMAGE DISP. ....	93		
FRAME NO. ....	94		
OPERATION VOL. ....	94		
SHUTTER VOLUME.....	94		
SHUTTER SOUND.....	94		
PLAYBACK VOLUME.....	95		
LCD BRIGHTNESS.....	95		
EVF/LCD MODE.....	95		
AUTO POWER OFF.....	95		
QUICK START MODE.....	95		
DUAL IS MODE.....	95		
RED EYE REMOVAL.....	96		
AF ILLUMINATOR.....	96		
AE/AF-LOCK MODE.....	96		
AE/AF-LOCK BUTTON.....	96		
RAW.....	96		
FOCUS CHECK.....	97		
		<b>Technical Notes</b>	
		<b>Optional Accessories</b> .....	99
		Accessories from FUJIFILM.....	100
		<b>Caring for the Camera</b> .....	101
		<b>Troubleshooting</b>	
		<b>Troubleshooting</b> .....	102
		<b>Warning Messages and Displays</b> .....	109
		<b>Appendix</b>	
		<b>Internal Memory/Memory Card Capacity</b> .....	113
		<b>Specifications</b> .....	114

# Introduction

## **Symbols and Conventions**

The following symbols are used in this manual:

 **Caution:** This information should be read before use to ensure correct operation.

 **Note:** Points to note when using the camera.

 **Tip:** Additional information that may be helpful when using the camera.

Menus and other text in the camera monitor are shown in bold. In the illustrations in this manual, the monitor display may be simplified for explanatory purposes.

## **Supplied Accessories**

The following items are included with the camera:

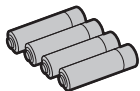

AA alkaline (LR6) batteries  
(x4)



Lens cap

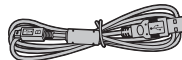

USB cable

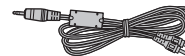

A/V cable



Lens hood







CD-ROM

- Strap
- Basic Manual

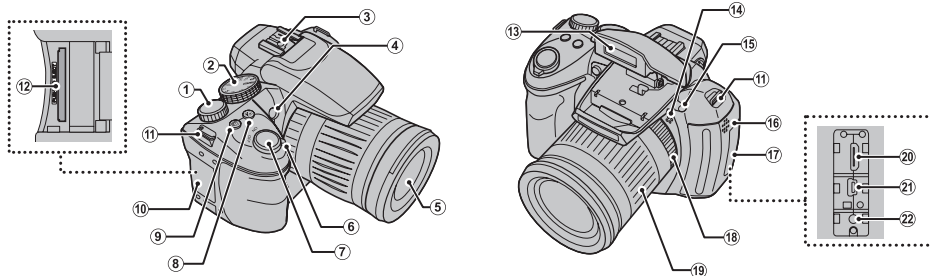
## Parts of the Camera

For more information, refer to the page listed to the right of each item.



<b>1</b> Command dial .....28, 38, 44	<b>8</b>  (exposure compensation) button .....37	<b>16</b> Speaker .....63, 89
<b>2</b> Mode dial .....21	<b>9</b>  (continuous shooting) button ..... 44	<b>17</b> Terminal cover
<b>3</b> Hot shoe .....83, 100	<b>10</b> Memory card slot cover ..... 11	<b>18</b> Focus ring .....41
<b>4</b> AF-assist illuminator .....96	<b>11</b> Strap eyelet.....7	<b>19</b> Zoom ring .....16
Self-timer lamp .....36	<b>12</b> Memory card slot .....11	<b>20</b> Connector for HDMI cable .....64
<b>5</b> Lens	<b>13</b> Flash.....34	<b>21</b> USB cable connector .....66, 76
<b>6</b> <b>ON/OFF</b> switch .....13	<b>14</b> Microphone.....61, 89	<b>22</b> A/V cable connector .....64
<b>7</b> Shutter button.....17	<b>15</b>  (flash pop-up) button.....34	

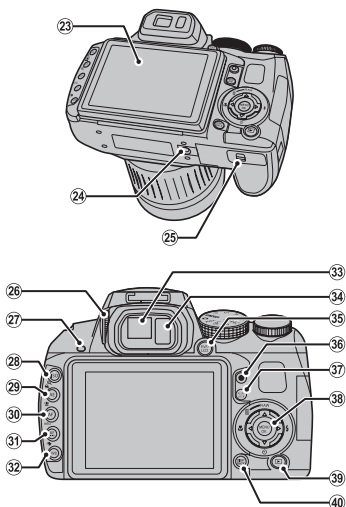

23	Monitor	5	32	WB (white balance) button	43
24	Tripod mount			(image search) button	57
25	Battery-chamber cover	8	33	Electronic viewfinder	4
26	Diopter adjustment control	4	34	Eye sensor	4
27	Indicator lamp	19	35	EVF/LCD (display selection) button	4
28	ISO (sensitivity) button	38	36	(movie record) button	61
	(playback zoom in) button	53	37	AE/AF LOCK (autoexposure/autofocus lock) button	32
29	AE (autoexposure) button	39	38	Selector button (see below)	
	(playback zoom out) button	53	39	(playback) button	52
30	AF (autofocus) button	40	40	DISP (display)/BACK button	18, 52
	(Intelligent Face Detection) button	53, 70			
31	AF C-S-M (focus mode) button	41			
	info button	56			

### The Selector Button

#### Move cursor up

RAW button (📖 18)/

(delete) button (📖 20)

MENU/OK button (📖 14)

#### Move cursor left

(macro) button (📖 33)

#### Move cursor right

(flash) button (📖 34)

#### Move cursor down

(self-timer) button (📖 36)

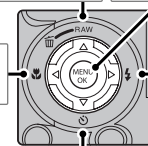

### The Electronic Viewfinder (EVF)

The electronic viewfinder provides the same information as the monitor, and can be used when bright lighting conditions make the display in the monitor difficult to see. Press **EVF/LCD** button to select from the auto switch, monitor, or electric view finder mode. When the auto switch mode is set, the electric view finder turns on automatically when you put your eye to the view finder, and the monitor turns on when you take your eye away (note that the eye sensor may not respond if you are wearing glasses or your head is at an angle to the camera).

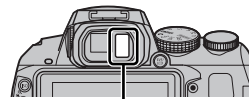
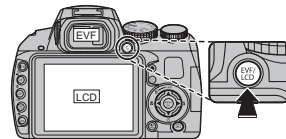

*Eye sensor*

The camera is equipped with diopter adjustment to accommodate individual differences in vision. Slide the diopter adjustment control up and down until the viewfinder display is in sharp focus.

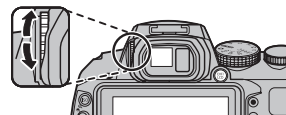



## Camera Displays

The following indicators may appear during shooting and playback. The indicators displayed vary with camera settings.

### Shooting

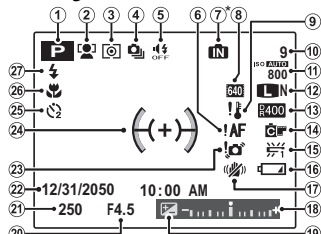

\* **IN**: indicates that no memory card is inserted and that pictures will be stored in the camera's internal memory (page 10).

1	Shooting mode.....	21	14	Film simulation .....	80
2	Intelligent Face Detection indicator.....	48	15	White balance .....	43
3	Metering .....	39	16	Battery level.....	6
4	Continuous shooting mode .....	44	17	Dual IS mode .....	95
5	Silent mode indicator.....	18, 92	18	Exposure indicator .....	37
6	Focus warning.....	17, 109	19	Exposure compensation .....	37
7	Internal memory indicator *		20	Aperture	
8	Movie mode .....	61	21	Shutter speed	
9	Temperature warning .....	105, 110	22	Date and time.....	14
10	Number of available frames.....	113	23	Blur warning.....	34, 109
11	Sensitivity.....	38	24	Focus frame.....	31
12	Image size/quality .....	78, 79	25	Self-timer indicator .....	36
13	Dynamic range.....	80	26	Macro (close-up) mode.....	33
			27	Flash mode.....	34

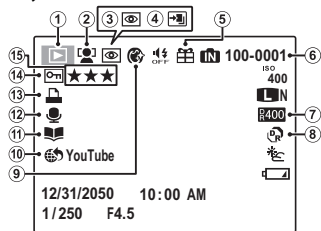

### Playback



1	Playback mode indicator .....	20, 52	8	<b>EXR</b> mode .....	22
2	Intelligent Face Detection indicator.....	48, 86	9	Portrait enhancer .....	25
3	Red-eye removal indicator .....	86	10	Mark for upload to.....	84
4	Pro focus mode, pro low-light mode.....	23, 24	11	Photobook assist .....	58
5	Gift image .....	52	12	Voice memo indicator.....	89
6	Frame number.....	94	13	DPOF print indicator .....	67
7	Dynamic range.....	80	14	Protected image.....	86
			15	Favorites .....	52

### Battery Level

Battery level is shown as follows:

Indicator	Description
NO ICON	Batteries are partially discharged.
 (red)	Batteries are low. Replace as soon as possible.
 (blinks red)	Batteries are exhausted. Turn camera off and replace batteries.

#### Note

A battery warning may not be displayed before the camera turns off, particularly if batteries are reused after having once been exhausted. Power consumption varies greatly from mode to mode; the low battery warning () may not be displayed or may be displayed only briefly before the camera turns off in some modes or when switching from shooting to playback mode.

### Hiding and Viewing Indicators

To choose the shooting information and guides displayed, press the **DISP/BACK** button.

# The Strap and Lens Cap

## Attaching the Strap

Attach the strap to the two strap eyelets as shown below.

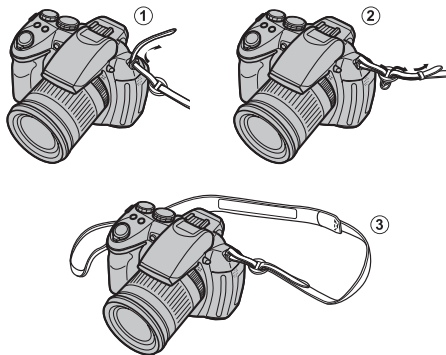

### Caution

To avoid dropping the camera, be sure the strap is correctly secured.

## The Lens Cap

Attach the lens cap as shown.

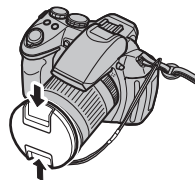

To avoid losing the lens cap, pass the supplied string through the eyelet (1) and secure the lens cap to the strap (2).

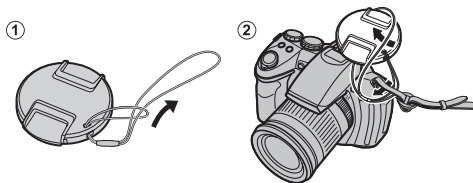

# Inserting the Batteries

The camera takes four AA alkaline, lithium, or rechargeable Ni-MH batteries. A set of four alkaline batteries is supplied with the camera. Insert the batteries in the camera as described below.

## 1 Open the battery-chamber cover.

Slide the battery-chamber latch in the direction shown and open the battery-chamber cover.

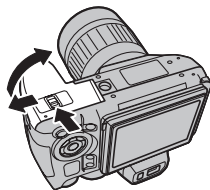

### Note

Be sure the camera is off before opening the battery-chamber cover.

### Cautions

- Do not open the battery-chamber cover when the camera is on. Failure to observe this precaution could result in damage to image files or memory cards.
- Do not use excessive force when handling the battery-chamber cover.

## 2 Insert the batteries.

Insert the batteries in the orientation shown by the "+" and "-" marks inside the battery chamber.

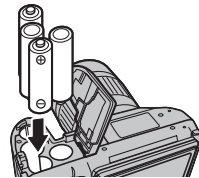

### Cautions

- Insert the batteries in the correct orientation.

- **Never use batteries with peeling or damaged casing or mix old and new batteries, batteries with different charge levels, or batteries of different types.**

Failure to observe these precautions could result in the batteries leaking or overheating.

- **Never use manganese or Ni-Cd batteries.**

- The capacity of alkaline batteries varies with the manufacturer and drops at temperatures below 10°C/50°F; Ni-MH batteries are recommended.
- Fingerprints and other soil on the battery terminals can shorten battery life.

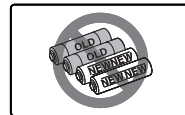
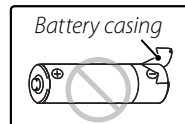

### 3 Close the battery-chamber cover.

Close the battery-chamber cover and slide it in until the latch clicks into place.

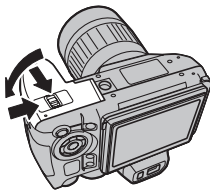

#### **Caution**

Do not use force. If the battery-chamber cover does not close, check that the batteries are in the correct orientation and try again.

#### **Tip: Using an AC Power Adapter**

The camera can be powered by an optional AC power adapter and DC coupler (sold separately).

#### **Choosing the Battery Type**

After replacing the batteries with batteries of a different type, select the battery type using the  **BATTERY TYPE** option in the setup menu (91) to ensure that the battery level is displayed correctly and the camera does not turn off unexpectedly.

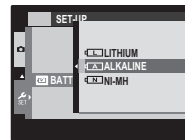

## Inserting a Memory Card

Although the camera can store pictures in internal memory, optional SD, SDHC and SDXC *memory cards* (sold separately) can be used to store additional pictures.

### ■ **Compatible Memory Cards**

FUJIFILM and SanDisk SD, SDHC and SDXC memory cards have been approved for use in the camera. A complete list of approved memory cards is available at [http://www.fujifilm.com/support/digital\\_cameras/compatibility/](http://www.fujifilm.com/support/digital_cameras/compatibility/). Operation is not guaranteed with other cards. The camera can not be used with **xD-Picture Cards** or MultiMediaCard (MMC) devices.

### ⚠ **Caution**

Memory cards can be locked, making it impossible to format the card or to record or delete images. Before inserting a memory card, slide the write-protect switch to the unlocked position.

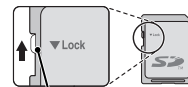

Write-protect  
switch

### ● **Memory Cards**

Pictures can be stored in the camera's internal memory or on optional SD, SDHC, and SDXC memory cards, referred to in this manual as "memory cards."

## ■ Inserting a Memory Card

### 1 Open the memory card slot cover.

#### ← Note

Be sure the camera is off before opening the memory card slot cover.

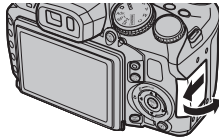

### 2 Insert the memory card.

Holding the memory card in the orientation shown below, slide it in until it clicks into place at the back of the slot.

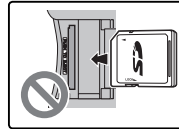
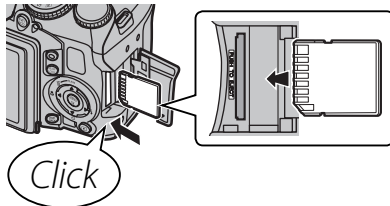

Be sure card is in the correct orientation; do not insert at an angle or use force. If the memory card is not correctly inserted or no memory card is inserted,  will appear in the LCD monitor and internal memory will be used for recording and playback.

### 3 Close the memory card slot cover.

#### ● Removing Memory Cards

After confirming that the camera is off, press the card in and then release it slowly. The card can now be removed by hand.

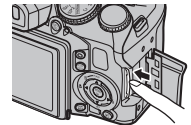

#### ⚠ Cautions

- The memory card may spring out if you remove your finger immediately after pushing the card in.
- Memory cards may be warm to the touch after being removed from the camera. This is normal and does not indicate a malfunction.

## Cautions

- **Do not turn the camera off or remove the memory card while the memory card is being formatted or data are being recorded to or deleted from the card.** Failure to observe this precaution could damage the card.
- Format SD/SDHC/SDXC memory cards before first use, and be sure to reformat all memory cards after using them in a computer or other device. For more information on formatting memory cards, see “ **FORMAT**” (📖 93).
- Memory cards are small and can be swallowed; keep out of reach of children. If a child swallows a memory card, seek medical assistance immediately.
- miniSD or microSD adapters that are larger or smaller than the standard dimensions of an SD/SDHC/SDXC card may not eject normally; if the card does not eject, take the camera to an authorized service representative. Do not forcibly remove the card.
- Do not affix labels to memory cards. Peeling labels can cause camera malfunction.
- Movie recording may be interrupted with some types of SD/SDHC/SDXC memory card. Use a **CLASS 4** card or better when shooting HD or high-speed movies.
- The data in internal memory may be erased or corrupted when the camera is repaired. Please note that the repairer will be able to view pictures in internal memory.
- Formatting a memory card or internal memory in the camera creates a folder in which pictures are stored. Do not rename or delete this folder or use a computer or other device to edit, delete, or rename image files. Always use the camera to delete pictures from memory cards and internal memory; before editing or renaming files, copy them to a computer and edit or rename the copies, not the originals.



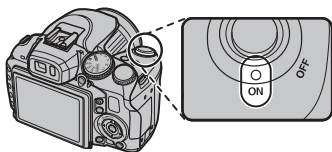

## Turning the Camera on and Off

Rotate the **ON/OFF** switch to **ON** to turn the camera on.



Select **OFF** to turn the camera off.



### **Tip: Switching to Playback Mode**

Press the  button to start playback. Press  button again or press the shutter button halfway to return to shooting mode.

### **Cautions**

- Pictures can be affected by fingerprints and other marks on the lens. Keep the lens clean.
- The **ON/OFF** switch does not completely disconnect the camera from its power supply.

### **Tip: Auto Power Off**

The camera will turn off automatically if no operations are performed for the length of time selected in the  **AUTO POWER OFF** menu ( 95). To reactivate the camera after it has turned off automatically, turn the **ON/OFF** switch to **OFF** and then back to **ON**.

# Basic Setup

A language-selection dialog is displayed the first time the camera is turned on. Set up the camera as described below (for information on resetting the clock or changing languages, see page 93).

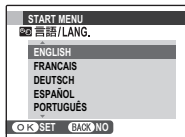

- 1 Highlight a language and press **MENU/OK**.

### ← Note

Press **DISP/BACK** to skip the current step. Any steps you skip will be displayed the next time the camera is turned on.

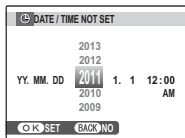

- 2 The date and time will be displayed. Press the selector left or right to highlight the year, month, day, hour, or minute and press up or down to change. To change the order in which the year, month, and day are displayed, highlight the date format and press the selector up or down. Press **MENU/OK** when settings are complete.

- 3 A battery type message will be displayed; if the type differs from the type inserted in the camera, use the setup menu **BATTERY TYPE** option (📖 9) to specify the correct type.

### 📖 Tip: The Camera Clock

If the batteries are removed for an extended period, the camera clock and battery type will be reset and the language-selection dialog will be displayed when the camera is turned on.



# Taking Pictures in **EXR AUTO** (EXR AUTO) Mode

This section describes how to take pictures in **EXR AUTO** (EXR AUTO) mode.

## 1 Select **EXR** mode.

Turn the camera on and rotate the mode dial to **EXR**. The **EXR AUTO** display will appear in the LCD monitor.



### The Icon

In **EXR AUTO** mode, the camera continuously adjusts focus and searches for faces, increasing the drain on the battery.  is displayed in the LCD monitor.

























































### EXR Icons (📖 23)

The camera analyses the scene and selects the preferred **EXR** mode.

<b>RESOLUTION PRIORITY</b>	
<b>HIGH ISO &amp; LOW NOISE</b>	
<b>D-RANGE PRIORITY</b>	

### Scene Icons

The camera automatically selects the appropriate scene.

Scene		AUTO	LAND-SCAPE	NIGHT	MACRO	BEACH	SUNSET	SNOW	SKY	GREENERY	SKY & GREENERY
<b>Main subject</b>											
<b>Non-portrait (landscape)</b>											
<b>Portrait</b>	<b>Normal lighting</b>	 	 	 	—	 	 	 	 	 	 
	<b>Back lighting</b>	 	 	—	—	 	 	 	 	 	 

\* If  is displayed, the camera will take a series of shots (Advanced anti blur; 📖 22).

### Caution

The mode selected may vary with shooting conditions. If the mode and subject do not match, select  mode (📖 23) or choose **SP1/SP2** (📖 25) and select a scene manually.

## 2 Frame the picture.

Use the zoom ring to frame the picture in the display.

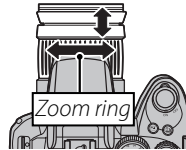

*Rotate left to zoom out*

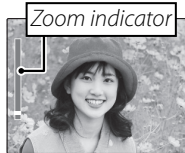

*Rotate right to zoom in*



### **Tip: Focus Lock**

Use focus lock ( 31) to focus on subjects that are not in the focus frame.

### **Holding the Camera**

Hold the camera steady with both hands and brace your elbows against your sides. Shaking or unsteady hands can blur your shots.

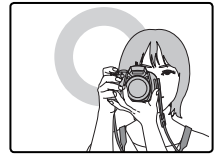

To prevent pictures that are out of focus or too dark (underexposed), keep your fingers and other objects away from the lens and flash.



### 3 Focus.

Press the shutter button halfway to focus.



**If the camera is able to focus**, it will beep twice and the indicator lamp will glow green.

**If the camera is unable to focus**, the focus frame will turn red, **!AF** will be displayed, and the indicator lamp will blink green. Change the composition or use focus lock (📖 31).

### 4 Shoot.

Smoothly press the shutter button the rest of the way down to take the picture.



#### Tip: The Shutter Button

The shutter button has two positions. Pressing the shutter button halfway (①) sets focus and exposure; to shoot, press the shutter button the rest of the way down (②).

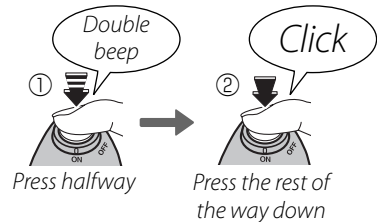



#### Note

If the subject is poorly lit, the AF-assist illuminator may light to assist focus (📖 96). For information on using the flash when lighting is poor, see page 34.

### Silent Mode

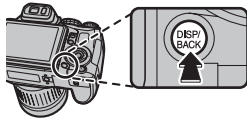
In situations in which camera sounds or lights may be unwelcome, hold the **DISP/BACK** button down until  is displayed (note that silent mode is not available during movie or voice memo playback).



The camera speaker, flash, and AF-assist illuminator/self-timer lamp turn off and flash and volume settings can not be adjusted (note that the flash will still fire when  is selected in scene mode). To restore normal operation, press the **DISP/BACK** button until the  icon is no longer displayed.

### RAW button

Press the **RAW** button to temporarily change the recording format. After shooting a picture, the recording format will be back to the option selected for **RAW RAW** in the setup menu (📖 96).

<b>RAW options</b>	<b>RAW button pressed</b>
RAW+JPEG	→ JPEG
RAW	→ JPEG
OFF	→ RAW+JPEG

## The Indicator Lamp

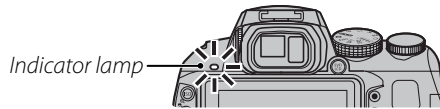

The indicator lamp shows camera status as follows:

Indicator lamp	Camera status
Glows green	Focus locked.
Blinks green	Blur, focus, or exposure warning. Picture can be taken.
Blinks green and orange	Recording pictures. Additional pictures can be taken.
Glows orange	Recording pictures. No additional pictures can be taken at this time.
Blinks orange	Flash charging; flash will not fire when picture is taken.
Blinks red	Lens or memory error (memory card full or not formatted, format error, or other memory error).

### Tip: Warnings

Detailed warnings appear in the display. See pages 109–112 for more information.

# Viewing Pictures

Pictures can be viewed in the monitor. When taking important photographs, take a test shot and check the results.

- 1 Press the  button.

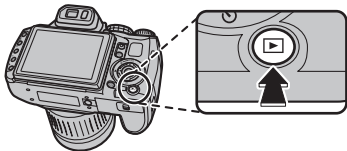

The most recent picture will be displayed in the monitor.



- 2 View additional pictures.

Press the selector right to view pictures in the order recorded, left to view pictures in reverse order.



Press the shutter button to exit to shooting mode.

## Deleting Pictures

To delete the picture currently displayed in the monitor, press the selector up () . The following dialog will be displayed.

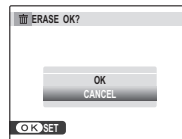

To delete the picture, highlight **OK** and press **MENU/OK**. To exit without deleting the picture, highlight **CANCEL** and press **MENU/OK**.



### Tip: The Playback Menu

Pictures can also be deleted from the playback menu ( 55).



# Shooting Mode

Choose a shooting mode according to the scene or type of subject. To choose a shooting mode, rotate the mode dial to the desired setting. The following modes are available:

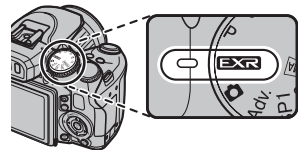

**EXR:** Improve clarity, reduce noise, increase dynamic range, or let the camera automatically adjust settings to suit the scene (📖 22).

**📷 (AUTO):** A simple “point-and-shoot” mode recommended for first-time users of digital cameras (📖 23).

**Adv. (ADVANCED):** Sophisticated techniques made easy (📖 23).

**P, S, A, M:** Select for full control over camera settings, including aperture (**M** and **A**) and/or shutter speed (**M** and **S**) (📖 28).

**C (CUSTOM):** Recall stored settings for modes **P, S, A, M** and all **EXR** modes except **EXR AUTO** (📖 30).

**PANORAMA (MOTION PANORAMA 360):** Select for taking a panorama (📖 27).

**SP1, SP2 (SCENE POSITION):** Choose a scene suited to the subject or shooting conditions and let the camera do the rest (📖 25).

## **EXR (EXR AUTO/EXR Priority)**

Optimize settings for your current subject or improve clarity, reduce noise, or enhance dynamic range. Rotate the mode dial to **EXR** and choose one of the following **EXR** modes in the shooting menu.



### **EXR AUTO (EXR AUTO)**

The camera automatically selects the scene and **EXR** mode according to shooting conditions (📖 15).

#### **Note**

If **AUTO** is selected for **IMAGE SIZE** in **EXR AUTO** mode, the camera will automatically select the optimal image size.

### **Advanced Anti Blur**

When **AB** is displayed, the camera will take a series of exposures and combine them to form a single image, reducing “noise” (mottling) and blur.

#### **Note**



**AB** is available when **ON** is selected in the shooting menu (📖 81) and the flash (📖 34) is off or set to auto.

#### **Cautions**

- Some time may be required to combine the exposures into a single image. A single combined image may not be created if the subject or camera moves during shooting. Keep the camera steady during shooting and do not move the camera until shooting is complete.
- Frame coverage is reduced.

## ■ EXR Priority

Choose from the following options:

-  (**RESOLUTION PRIORITY**): Choose for crisp, clear shots.
-  (**HIGH ISO & LOW NOISE**): Reduce noise in pictures taken at high sensitivities.
-  (**D-RANGE PRIORITY**): Increase the amount of detail visible in highlights.

 **DYNAMIC RANGE** (  80) can be set to  1600 (1600%) and  800 (800%).

## **AUTO**

Choose for crisp, clear snapshots. This mode is recommended in most situations.

## **Adv. ADVANCED**

This mode combines “point-and-shoot” simplicity with sophisticated photographic techniques. The  **Adv. MODE** option in the shooting menu can be used to choose from the following advanced modes:



## ■ **PRO FOCUS**

The camera takes up to three shots each time the shutter button is pressed, softening the background to emphasize the main subject. The amount of softening can be adjusted before shooting by rotating the command dial. Use for portraits or photos of flowers similar to those produced by SLR cameras.



### ← **Note**

Softening can not be applied to background objects that are too close to the main subject. If a message stating that the camera can not create the effect is displayed when the camera focuses, try backing away from your subject and zooming in. The camera may also be unable to soften the background if the subject is moving; if prompted, check the results and try again.

### ■ PRO LOW-LIGHT

Each time the shutter button is pressed, the camera makes four exposures and combines them into a single photograph. Use to reduce noise and blur when photographing poorly lit subjects or static subjects at high zoom ratios.



#### ← Note

A single combined photograph may not be created with some scenes or if the subject or camera moves during shooting. Do not move the camera until shooting is complete.

### PRO FOCUS/PRO LOW-LIGHT

To save unprocessed copies of pictures taken in these modes, select **ON** for the  **SAVE ORG IMAGE** option in the setup menu (📖 97).

















#### Cautions

- Keep the camera steady during shooting.
- Frame coverage is reduced.

## **SP1/SP2 SCENE POSITION**

The camera offers a choice of “scenes,” each adapted to particular shooting conditions or a specific type of subject. Use the  **SCENE POSITION** option in the shooting menu to choose the scene assigned to the **SP1/SP2** position on the mode dial.



Scene	Description
 <b>NATURAL &amp; FLASH</b>	The camera takes two shots: one without the flash and one with.
 <b>NATURAL LIGHT</b>	Capture natural lighting under low-light conditions.
 <b>PORTRAIT</b>	Choose for portraits.
 <b>PORTRAIT ENHANCER</b>	Choose for a smooth skin effect when shooting portraits.
 <b>DOG</b>	Choose when photographing dogs.
 <b>CAT</b>	Choose when photographing cats.
 <b>LANDSCAPE</b>	Choose for daylight shots of buildings and landscapes.
 <b>SPORT</b>	Choose when photographing moving subjects.
 <b>NIGHT</b>	Choose this mode for poorly lit twilight or night scenes.
 <b>NIGHT (TRIPOD)</b>	Choose this mode for slow shutter speeds when shooting at night.
 <b>FIREWORKS</b>	Slow shutter speeds are used to capture the expanding burst of light from a firework.
 <b>SUNSET</b>	Choose this mode to record the vivid colors in sunrises and sunsets.
 <b>SNOW</b>	Choose for crisp, clear shots that capture the brightness of scenes dominated by shining white snow.
 <b>BEACH</b>	Choose for crisp, clear shots that capture the brightness of sunlit beaches.
 <b>PARTY</b>	Capture indoor background lighting under low-light conditions.
 <b>FLOWER</b>	Choose for vivid close-ups of flowers.
 <b>TEXT</b>	Take clear pictures of text or drawings in print.

 DOG/CAT

The camera focuses on the faces of dogs or cats that are facing the camera, and the self-timer menu offers a  **AUTO RELEASE** option that releases the shutter automatically when a pet is detected (📖 36). During playback, image search (📖 57) can be used to search for pictures taken in either mode.

 **Note**

Although camera can detect many different breeds of dogs and cats, results may vary with the breed and shooting conditions. The camera may fail to detect pets with dark-colored faces or long hair covering their entire face. If a dog or cat is not detected, the camera focuses on the subject at the center of the frame.

**PANORAMA** **MOTION PANORAMA 360**

Follow an on-screen guide to take photos that will automatically be joined to form a panorama.

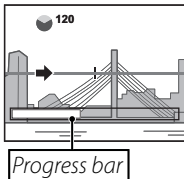

- 1** Rotate the zoom ring until the zoom indicator turns white.
- 2** To select the angle through which you will pan the camera while shooting, press the selector down. Press the selector left or right to highlight an angle and press **MENU/OK**.
- 3** Press the selector right to view a choice of pan directions. Press the selector left or right to highlight a pan direction and press **MENU/OK**.
- 4** Press the shutter button all the way down to start recording. There is no need to keep the shutter button pressed during recording.
- 5** Pan the camera in the direction shown by the arrow. Shooting ends automatically when the progress bar is full and the panorama is complete.

**Note**

Shooting ends if the shutter button is pressed all the way down during shooting. No panorama will be recorded if the shutter button is pressed before the camera has been panned through 120°.

**Cautions**

- Panoramas are created from multiple frames. The camera may in some cases record a greater or lesser angle than selected or be unable to stitch the frames together perfectly. The last part of the panorama may not be recorded if shooting ends before the panorama is complete.
- Shooting may be interrupted if the camera is panned too quickly or too slowly. Panning the camera in a direction other than that shown cancels shooting.
- The desired results may not be achieved with moving subjects, subjects close to the camera, unvarying subjects such as the sky or a field of grass, subjects that are in constant motion, such as waves and waterfalls, or subjects that undergo marked changes in brightness. Panoramas may be blurred if the subject is poorly lit.

### For Best Results

For best results, move the camera in a small circle at a steady speed, keeping the camera horizontal and being careful only to pan in the direction shown by the guides. If the desired results are not achieved, try panning at a different speed.

## **P: PROGRAM AE**

In this mode, the camera sets exposure automatically. If desired, you can choose different combinations of shutter speed and aperture that will produce the same exposure (program shift).



### Caution

If the subject is outside the metering range of the camera, the shutter speed and aperture displays will show "---". Press the shutter button halfway to measure exposure again.

### Program Shift

Rotate the command dial to choose the desired combination of shutter speed and aperture. The default values can be restored by raising the flash, rotating the mode dial to another setting, turning the camera off, or selecting playback mode. The flash must be off for Program shift to be available. Furthermore, an option other than **AUTO** must be selected for **D-Ring DYNAMIC RANGE** and **ISO ISO**.

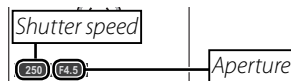



## **S: SHUTTER PRIORITY AE**

You choose the shutter speed using the command dial, while the camera adjusts aperture for optimal exposure.

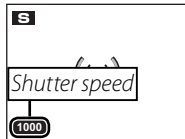

### **⚠ Cautions**

- If the correct exposure can not be achieved at the selected shutter speed, aperture will be displayed in red. Adjust shutter speed until the correct exposure is achieved. If the subject is outside the metering range of the camera, the aperture display will show "F---". Press the shutter button halfway to measure exposure again.
- The shutter speed is restricted depending on the ISO setting.

## **A: APERTURE PRIORITY AE**

You choose the aperture using the command dial, while the camera adjusts shutter speed for optimal exposure.

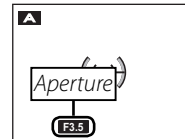

### **⚠ Caution**

If the correct exposure can not be achieved at the selected aperture, shutter speed will be displayed in red. Adjust aperture until the correct exposure is achieved. If the subject is outside the metering range of the camera, the shutter speed display will show "----". Press the shutter button halfway to measure exposure again.

## M: MANUAL

In this mode, you choose both shutter speed and aperture. If desired, exposure can be altered from the value suggested by the camera.

Rotate the command dial to set the shutter speed. Press and hold the  button and rotate the command dial to set the aperture value.

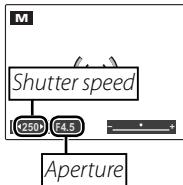

### Cautions

- Noise in the form of randomly-spaced bright pixels may occur in long exposures.
- The shutter speed is restricted depending on the ISO setting.

### The Exposure Indicator



















The amount the picture will be under- or over-exposed at current settings is shown by the exposure indicator.



## C: CUSTOM MODE

In **P**, **S**, **A**, **M** and all **EXR** modes except **EXR AUTO**, the **CS** CUSTOM SET option in the shooting menu ( 83) can be used to save current camera and menu settings. These settings are recalled whenever the mode dial is rotated to **C** (custom mode).



Menu/setting	Settings saved
Shooting menu	ISO ISO,  IMAGE SIZE,  IMAGE QUALITY,  DYNAMIC RANGE,  FILM SIMULATION,  WB SHIFT,  COLOR,  TONE,  SHARPNESS,  NOISE REDUCTION,  FACE DETECTION,  FACE RECOGNITION,  MOVIE AF MODE,  MOVIE MODE,  ELECTRONIC LEVEL,  AE BKT EV STEPS,  FLASH,  EXTERNAL FLASH
Setup menu	 AF ILLUMINATOR,  RAW
Other	ISO, metering, autofocus mode, focus mode, white balance, burst mode, macro mode, flash mode, exposure compensation, monitor display options ( <b>DISP/BACK</b> button)

# Focus Lock

To compose photographs with off-center subjects:

## 1 Position the subject in the focus frame.

## 2 Focus.

Press the shutter button halfway to set focus and exposure. Focus and exposure will remain locked while the shutter button is pressed halfway (AF/AE lock).



## 3 Recompose the picture.

Keeping the shutter button pressed halfway, re-compose the picture.



## 4 Shoot.



### Autofocus

Although the camera boasts a high-precision autofocus system, it may be unable to focus on the subjects listed below. If the camera is unable to focus using autofocus, use focus lock to focus on another subject at the same distance and then recompose the photograph.

- Very shiny subjects such as mirrors or car bodies.
- Fast-moving subjects.
- Subjects photographed through a window or other reflective object.
- Dark subjects and subjects that absorb rather than reflect light, such as hair or fur.
- Insubstantial subjects, such as smoke or flame.
- Subjects that show little contrast with the background (for example, subjects in clothing that is the same color as the background).
- Subjects positioned in front of or behind a high-contrast object that is also in the focus frame (for example, a subject photographed against a backdrop of highly contrasting elements).

# The AE/AF LOCK Button

The **AE/AF LOCK** button can be used to lock exposure or focus.

## Locking Exposure

### 1 Meter exposure.

Position the subject in the focus frame and press the **AE/AF LOCK** button to meter exposure.

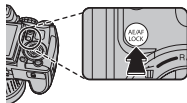

### 2 Focus.

Keeping the **AE/AF LOCK** button pressed, press the shutter button halfway to focus. Focus and exposure will remain locked while the shutter button is pressed halfway, even if you later release the **AE/AF LOCK** button.



Repeat steps 1 and 2 as desired to refocus before taking the picture.

### 3 Recompose the picture.

Keeping the shutter button pressed halfway, recompose the picture.

#### ⚠ Caution

Adjusting zoom ends AE lock. AE lock is not available with Intelligent Face Detection.

### 4 Shoot.



## Locking Focus

If **AF LOCK ONLY** is selected for **AE/AF-L** **AE/AF-LOCK BUTTON** in the setup menu (📖 96), pressing the **AE/AF LOCK** button locks focus. If **AE/AF LOCK** is selected, both focus and exposure will be locked.



#### 👉 Note

If **AE&AF ON/OFF SWITCH** is selected for **AE-L** **AE/AF-LOCK MODE** in the setup menu (📖 96), exposure and/or focus will lock when the **AE/AF LOCK** button is pressed and remain locked until the button is pressed again.

## Macro and Super Macro Modes (Close-ups)

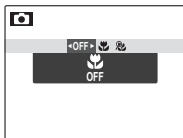
For close-ups, press the selector left () to choose from the macro options shown below.



Choose from  (macro mode),  
 (super macro mode), or  
**OFF** (macro mode off)

When macro mode is in effect, the camera focuses on subjects near the center of the frame. Use the zoom ring to compose pictures. The following restrictions apply in super macro mode: the lens must be zoomed all the way out (at other zoom positions,  is displayed) and the flash can not be used.

### Notes

- Use of a tripod is recommended to prevent blur caused by camera shake.
- Flash compensation may be required when using the flash ( 82).
- Using the flash at close range may cast a lens shadow. Zoom a little or have more distance from the subject.

## ⚡ Using the Flash (Super-Intelligent Flash)

When the flash is used, the camera's *Super-Intelligent Flash* system instantly analyzes the scene based on such factors as the brightness of the subject, its position in the frame, and its distance from the camera. Flash output and sensitivity are adjusted to ensure that the main subject is correctly exposed while preserving the effects of ambient background lighting, even in dimly-lit indoor scenes. Use the flash when lighting is poor, for example when shooting at night or indoors under low light.

### 1 Raise the flash.

Press the flash pop-up button to raise the flash.

#### ● Turning the Flash Off

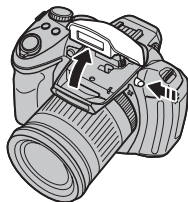

Lower the flash where flash photography is prohibited or to capture natural lighting under dim light. At slow shutter speeds,  will be displayed to warn that pictures may be blurred; use of a tripod is recommended.



### 2 Choose a flash mode.

Press the selector right () . The flash mode changes each time the selector is pressed.



Mode	Description
 (AUTO FLASH)	The flash fires when required. Recommended in most situations.
 (FORCED FLASH)	The flash fires whenever a picture is taken. Use for backlit subjects or for natural coloration when shooting in bright light.
 (SLOW SYNCHRO)	Capture both the main subject and the background under low light (note that brightly lit scenes may be overexposed).







 **Caution**

The flash may fire several times with each shot. Do not move the camera until shooting is complete.

 **Note**

The peripheral part of an image may be dark when using the flash.

 **Red-Eye Removal**

When Intelligent Face Detection is active ( 48), and **ON** is selected for  **RED EYE REMOVAL** in the setup menu ( 96), red-eye removal is available in  **AUTO**,  **⚡**, and  **SLW**.

Red-eye removal minimizes “*red-eye*” caused when light from the flash is reflected from the subject’s retinas as shown in the illustration at right.



## ⌚ Using the Self-Timer

To use the self-timer, press the selector down (⌚) and choose from the following options:

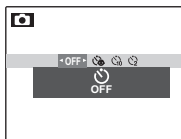

Option	Description
⌚ (OFF)	Self-timer off.
⌚ (AUTO RELEASE)	The shutter is released automatically when the camera detects a human portrait subject facing the camera. Use for portraits of babies.
⌚ (10 SEC)	The shutter is released ten seconds after the shutter button is pressed. Use for self-portraits. The self-timer lamp on the front of the camera lights when the timer starts and begins to blink shortly before the photo is taken.
⌚ (2 SEC)	The shutter is released two seconds after the shutter button is pressed. Use to reduce blur caused by the camera moving when the shutter button is pressed. The self-timer lamp will blink as the timer counts down.



## Exposure Compensation

Use exposure compensation when photographing very bright, very dark, or high-contrast subjects.

Press the  button and rotate the command dial until the exposure indicator shows the desired value.

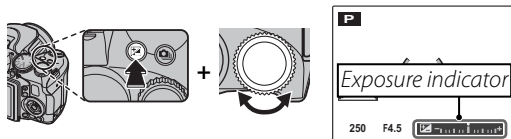

The effect is visible in the display.

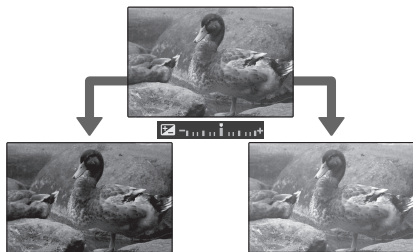

Choose negative values  
to reduce exposure  
("–" sign turns yellow)

Choose positive values to  
increase exposure  
("+ sign turns yellow)

### Note

A  icon and exposure indicator are displayed at settings other than  $\pm 0$ . Exposure compensation is not reset when the camera is turned off; to restore normal exposure control, choose a value of  $\pm 0$ .

# Sensitivity

The camera's sensitivity to light can be adjusted by pressing the **ISO** button and rotating the command dial until the desired value is highlighted in the display.

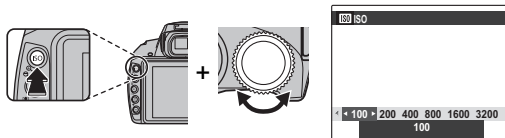

## ISO

Higher values can reduce blur; note, however, that mottling may appear in pictures taken at high sensitivities.

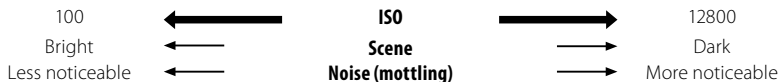



Option	Description
<b>AUTO</b>	Sensitivity is adjusted automatically in response to shooting conditions.
<b>AUTO (3200) / AUTO (1600) / AUTO (800) / AUTO (400)</b>	As above, except that sensitivity will not be raised above the value in parentheses.
<b>12800 / 6400 / 3200 / 1600 / 800 / 400 / 200 / 100</b>	Sensitivity is set to the specified value, which is shown in the display.

## Metering

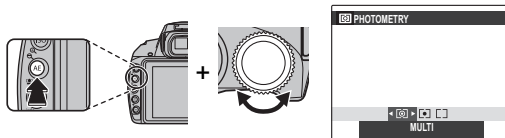
To choose how the camera meters exposure when Intelligent Face Detection is off, press the **AE** button and rotate the command dial.



Option	Description
 (MULTI)	Automatic scene recognition is used to adjust exposure for a wide range of shooting conditions.
 (SPOT)	The camera meters lighting conditions at the center of the frame. Recommended when the background is much brighter or darker than the main subject.
 (AVERAGE)	Exposure is set to the average for the entire frame. Provides consistent exposure across multiple shots with the same lighting, and is particularly effective for landscapes and portraits of subjects dressed in black or white.

# Autofocus Mode

To choose how the camera selects the focus area when **AF-S** is selected for focus mode (📖 41), press the **AF** button and rotate the command dial. Note that regardless of the option selected, the camera will focus on the subject in the center of the monitor when macro mode is on (📖 33).

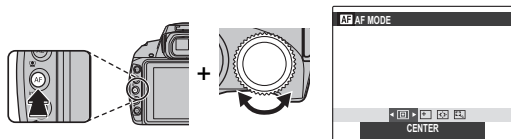

The following options are available:

- **[C]** (CENTER): The camera focuses on the subject in the center of the frame. This option can be used with focus lock.
- **[+]** (MULTI): When the shutter button is pressed halfway, the camera detects high-contrast subjects near the center of the frame and selects the focus area automatically.

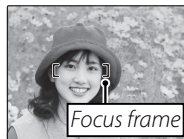
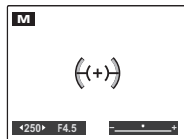

- **[+]** (AREA): The focus position can be chosen manually by pressing the selector up, down, left, or right and pressing **MENU/OK** when the focus brackets are in the desired position. Choose for precise focus when the camera is mounted on a tripod.
- **[+]** (TRACKING): Position the subject in the focus target and press the selector left. The camera will track the subject and adjust focus as it moves through the frame.

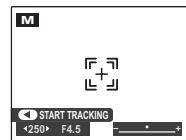
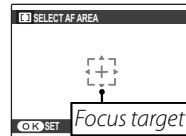

# Focus Mode

To choose how the camera focuses, press the **AF C-S-M** button and rotate the command dial.

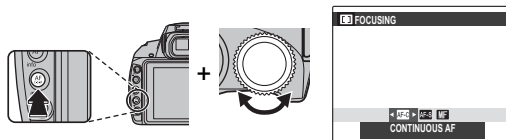

The following options are available:

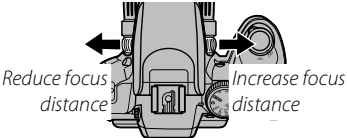
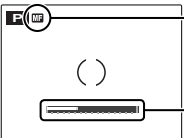
Mode	Description
<b>AF-S</b> (SINGLE AF)	Focus locks while the shutter button is pressed halfway. Choose for stationary subjects.
<b>AF-C</b> (CONTINUOUS AF)	The camera continually adjusts focus to reflect changes in the distance to the subject even when the shutter button is not pressed halfway (note that this increases the drain on the batteries).  (CENTER) is automatically selected for autofocus mode (📖 40); if Intelligent Face Detection is on, the camera will continually adjust focus for the selected face. Choose for moving subjects.
<b>MF</b> (MF)	Focus manually using the focus ring. Rotate the ring left to reduce the focus distance, right to increase. The manual focus indicator indicates how closely the focus distance matches the distance to the subject in the focus brackets. Choose for manual control of focus or in situations in which the camera is unable to focus using autofocus (📖 31). Intelligent Face Detection turns off automatically. <div style="display: flex; justify-content: space-around; align-items: center; margin-top: 10px;"> <div style="text-align: center;">  <p>Reduce focus distance</p> <p>Increase focus distance</p> </div> <div style="text-align: center;">  <p>Manual focus mode icon</p> <p>Manual focus indicator</p> </div> </div>

**← Notes: Manual Focus**

- Use of a tripod is recommended. Focus may be affected if the camera moves.
- If **ON** is selected for **MF FOCUS CHECK** in the setup menu (📖 97), the whole image will be magnified to assist focus when the focus ring is rotated.
- The camera will not focus when the focus ring is rotated all the way to the right. To focus at infinity, focus on a distant object.
- To focus using autofocus (📖 40), press the **AE/AF LOCK** button. This can be used to quickly focus on a chosen subject in manual focus mode.

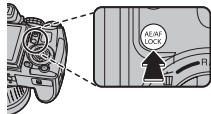

# White Balance

For natural colors, press the **WB** button and rotate the command dial until a setting that matches the light source is highlighted in the display.

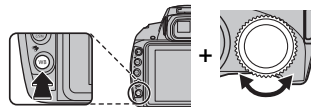

Option	Description
<b>AUTO</b>	White balance adjusted automatically.
	Measure a value for white balance.
	For subjects in direct sunlight.
	For subjects in the shade.
	Use under "daylight" fluorescent lights.
	Use under "warm white" fluorescent lights.
	Use under "cool white" fluorescent lights.
	Use under incandescent lighting.

## Custom White Balance

Choose to adjust white balance for unusual lighting conditions. White balance measurement options will be displayed; frame a white object so that it fills the LCD monitor and press the shutter button all the way down to measure white balance.

- If **"COMPLETED!" is displayed**, press **MENU/OK** to set white balance to the measured value.
- If **"UNDER" is displayed**, raise exposure compensation ( 37) and try again.
- If **"OVER" is displayed**, lower exposure compensation and try again.

### Note

For greater precision, adjust **FILM SIMULATION**, **ISO**, and **DYNAMIC RANGE** before measuring white balance.

### Notes

- At settings other than , auto white balance is used with the flash.
- Results vary with shooting conditions. Play pictures back after shooting to check colors in the LCD monitor.

## Continuous Shooting (Burst Mode)

Capture motion or automatically vary selected settings over a series of pictures.

Press the  button and rotate the command dial to choose from the options below:

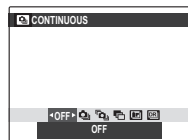
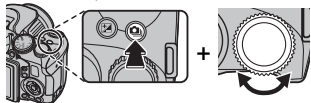

**OFF:** OFF

: TOP

: BEST FRAME CAPTURE

: AE BKT

: FILM SIMULATION BKT

: DYNAMIC RANGE BKT

### Notes

- Focus and exposure are determined by the first frame in each series. The flash turns off automatically; the previously-selected flash mode is restored when continuous shooting is turned off.
- Frame rate varies with shutter speed.
- The number of pictures that can be taken in a single burst varies with the scene and camera settings. The number of pictures that can be recorded depends on the memory available.



■ 📷 **TOP n**

The camera takes photographs while the shutter button is pressed. To choose the frame rate and maximum number of shots per burst:

1 Press the selector right when the camera is in shooting mode.

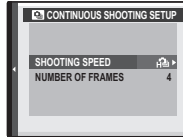

2 Highlight the current frame rate or number of shots and press the selector right, then press selector up or down to choose a new value and press **MENU/OK** to select.

3 Press **DISP/BACK** to return to shooting mode when settings are complete.

■ 📷 **BEST FRAME CAPTURE**

The camera takes a series of pictures, starting before and ending after the shutter button is pressed. To choose the frame rate and number of shots:

1 Press the selector right when the camera is in shooting mode.

2 Highlight the current frame rate and press the selector right, then press selector up or down to choose a new value and press **MENU/OK** to select.

⚠ **Caution**

Some frame rates may reduce the number of shots available in Step 3.

3 Highlight the number of shots and press the selector right. Press the selector up or down to choose the number of shots in each burst and left or right to choose their distribution (the number on the left is taken *before* and the number on the right *after* the shutter button is pressed). Press **MENU/OK** when settings are complete.

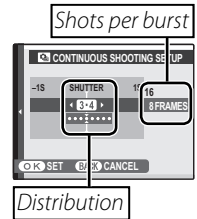

- 4 Press **DISP/BACK** to return to shooting mode.
- 5 Take photographs. The camera begins recording while the shutter button is pressed halfway, and completes the burst when the shutter button is pressed all the way down. The illustration shows a burst of eight shots, three before the shutter button is pressed and four after.

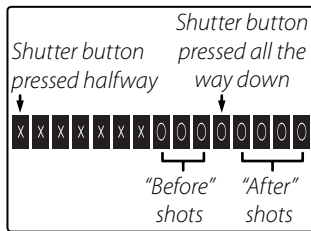

#### ⚠ Cautions

- If the shutter button is pressed all the way down before the number of frames selected for the "before" portion is recorded, the remaining frames will be taken after the shutter button is pressed all the way down.
- If the shutter button is pressed halfway for an extended period, the camera may record the burst before the shutter button is pressed all the way down.







#### ■ AE BKT

Each time the shutter button is pressed, the camera takes three shots: one using the metered value for exposure, the second overexposed by the amount selected for **AE BKT EV STEPS** in the shooting menu (📖 82), and the third underexposed by the same amount (the camera may not be able to use the selected bracketing increment if the amount of over- or under- exposure exceeds the limits of the exposure metering system).

** FILM SIMULATION BKT**







Each time the shutter button is pressed, the camera takes three shots at different ** FILM SIMULATION** settings (📖 80): ** PROVIA/STANDARD** for the first, ** Velvia/VIVID** for the second, and ** ASTIA/SOFT** for the third.

** DYNAMIC RANGE BKT**

Each time the shutter button is pressed, the camera takes three shots at different ** DYNAMIC RANGE** settings (📖 80): ** 100%** for the first, ** 200%** for the second, and ** 400%** for the third (** ISO** can not exceed 3200; values less than 400 are not available when ** L** is selected for ** IMAGE SIZE**).

** RAW RAW**

The number of pictures that can be recorded in a single burst varies with the option selected for ** RAW** in the setup menu.

	<b> RAW</b>		
<b> CONTINUOUS</b>	<b>RAW+JPEG</b>	<b>RAW</b>	<b>OFF (JPEG)</b>
<b> TOP n</b>	Up to 6	Up to 6	Up to 32
<b> BEST FRAME CAPTURE</b>	Up to 6	Up to 6	Up to 16
<b> AE BKT</b>	3	3	3
<b> FILM SIMULATION BKT</b>	—	—	3
<b> DYNAMIC RANGE BKT</b>	—	—	3

## Intelligent Face Detection

Intelligent Face Detection allows the camera to automatically detect human faces and set focus and exposure for a face anywhere in the frame for shots that emphasize portrait subjects. Choose for group portraits (in horizontal or vertical orientations) to prevent the camera from focusing on the background.

To use Intelligent Face Detection, press **MENU/OK** to display the shooting menu and select **ON** for ** FACE DETECTION**. Faces can be detected with the camera in vertical or



*Green border*

horizontal orientation; if a face is detected, it will be indicated by a green border. If there is more than one face in the frame, the camera will select the face closest to the center; other faces are indicated by white borders.





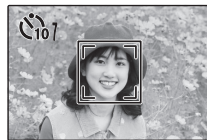

### Cautions

- In some modes, the camera may set exposure for the frame as a whole rather than the portrait subject.
- If the subject moves as the shutter button is pressed, their face may not be in the area indicated by the green border when the picture is taken.

### Intelligent Face Detection

Intelligent Face Detection is recommended when using the self-timer for group- or self-portraits ( 36).



When a picture taken with Intelligent Face Detection is displayed, the camera can automatically select faces for red-eye removal ( 86), playback zoom ( 53), slide shows ( 85), image search ( 57), image disp. ( 93), printing ( 66), and cropping ( 87).

## Face Recognition

The camera can store information on the face and personal details (name, relationship, and birth date) of portrait subjects and assign these subjects priority for Intelligent Face Detection or display their names and other information during playback.

### **Adding New Faces**

Follow the steps below to add faces to the face recognition database.

#### **1** Select **REGISTER**.

Select **REGISTER** for  **FACE RECOGNITION** in the shooting menu.

#### **Note**

To disable face recognition, select **OFF**.

#### **2** Take a photograph.

After checking that the subject is facing the camera, frame the subject using the guides and take the photograph.



#### **Note**

If an error is displayed, take the photograph again.

#### **3** Enter face recognition data.

Press **MENU/OK** to display face recognition data and enter the following information:

- **NAME:** Enter a name of up to 14 characters and press **MENU/OK**.
- **BIRTHDAY:** Enter the subject's date of birth and press **MENU/OK**.
- **CATEGORY:** Choose the option that describes your relationship to the subject and press **MENU/OK**.

#### **Note**

If you attempt to zoom in on the face of a person indicated by a green border in the face recognition database on their birthday, the camera will display their name and the message "Happy Birthday!".

## **Viewing, Editing, and Deleting Existing Data**

Follow the steps below to view, edit, or delete face recognition data.

- 1** Select **VIEW & EDIT** for  **FACE RECOGNITION**.
- 2** Select a face.
- 3** **View or edit face recognition data.**

The name, category, or birth date can be edited as described in Step 3 of “Adding New Faces” (📖 49). To retake the photo, select **REPLACING IMAGE** and shoot a new portrait as described above.

### **Note**

To delete face recognition data for the selected subject, select **ERASE**.

## **Adding Faces Automatically**

To automatically add frequently-photographed subjects to the face recognition database, select **ON** for **AUTO REGISTRATION** in the face recognition menu. If the camera detects a face that has been photographed many times without being added to the database, it will display a message prompting you to create a new face recognition entry. Press **MENU/OK** and enter face recognition data.

### **Note**

The camera may sometimes fail to recognize new faces automatically. If necessary, faces can be added manually using the **REGISTER** option.

### Face Recognition

The camera can store up to eight faces. If you attempt to add a ninth face, a confirmation dialog will be displayed; use **VIEW & EDIT** to make room for new faces by deleting existing data. **AUTO REGISTRATION** is disabled if there are already data for eight faces.

When Intelligent Face Detection ( 48) is on and the frame contains multiple subjects from the face recognition database, the camera displays the name of the subject that will be used to set focus and exposure (the subject shown by the green frame). If no name is entered, the camera will show "---". Subjects identified using face recognition but not used to set focus and exposure are shown by orange frames, other subjects by white frames.

### Caution

The camera may fail to identify subjects in the face recognition database if they are not facing the camera or are only partly in the frame, or if details of the subjects' faces or expressions differ markedly from those in the database.

## Playback Options

To view the most recent picture in the monitor, press the  button.

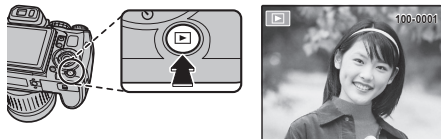

Press the selector right to view pictures in the order recorded, left to view pictures in reverse order. Keep the selector pressed to scroll rapidly to the desired frame.



### **Continuous Shooting**

In the case of pictures taken in continuous shooting mode, only the first frame of each series will be displayed. Press the selector down to view the other pictures in the series.

### **★ Favorites: Rating Pictures**



To rate the picture currently displayed in full-frame playback, press **DISP/BACK** and press the selector up and down to select from zero to five stars.

#### Note

Pictures taken using other cameras are indicated by a  ("gift image") icon during playback.



## Playback Zoom

Press  to zoom in on pictures displayed in single-frame playback;  to zoom out. When the picture is zoomed in, the selector can be used to view areas of the image not currently visible in the display.

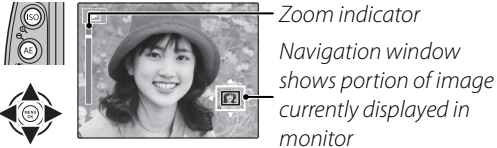





Press **DISP/BACK** or **MENU/OK** to exit zoom.

### Note

The maximum zoom ratio varies with image size. Playback zoom is not available with cropped or resized copies saved at a size of **640** or smaller.

## Intelligent Face Detection

Pictures taken with Intelligent Face Detection ( 31) are indicated by a  icon. Press the  button to zoom in on the subject selected with Intelligent Face Detection. You can then use the  and  buttons to zoom in and out.



## **Multi-Frame Playback**

To change the number of images displayed, press  in single-frame view.

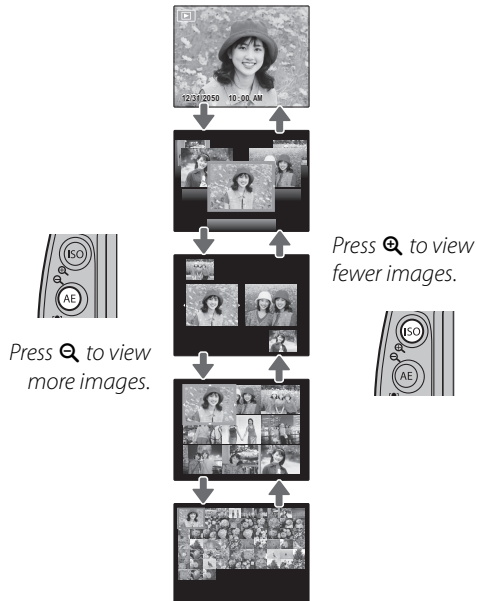



Use the selector to highlight images and press **MENU/OK** to view the highlighted image full frame. In the nine- and hundred-frame displays, press the selector up or down to view more pictures.

### **Tip: Two-Frame Display**

Two-frame display can be used to compare pictures taken in  mode.



## Deleting Pictures

To delete individual pictures, multiple selected pictures, or all pictures, press **MENU/OK**, select  **ERASE** ( 84), and choose from the options below. *Note that deleted pictures can not be recovered. Copy important pictures to a computer or other storage device before proceeding.*

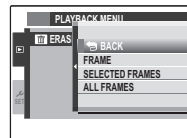

Option	Description
<b>FRAME</b>	Press the selector left or right to scroll through pictures and press <b>MENU/OK</b> to delete the current picture (a confirmation dialog is not displayed).
<b>SELECT FRAMES</b>	Highlight pictures and press <b>MENU/OK</b> to select or deselect (pictures included in the photobook or print order are shown by  ). When the operation is complete, press <b>DISP/BACK</b> to display a confirmation dialog, then highlight <b>OK</b> and press <b>MENU/OK</b> to delete the selected pictures.
<b>ALL FRAMES</b>	A confirmation dialog will be displayed; highlight <b>OK</b> and press <b>MENU/OK</b> to delete all unprotected pictures (if a memory card is inserted, only the pictures on the memory card will be affected; the pictures in internal memory are only deleted if no memory card is inserted). Pressing <b>DISP/BACK</b> cancels deletion; note that any pictures deleted before the button was pressed can not be recovered.

### Notes

- Protected pictures can not be deleted. Remove protection from any pictures you wish to delete ( 86).
- If a message appears stating that the selected images are part of a DPOF print order, press **MENU/OK** to delete the pictures.

# Viewing Photo Information

To view or hide the photo information listed below in single-frame playback, press **info**.

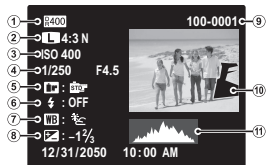
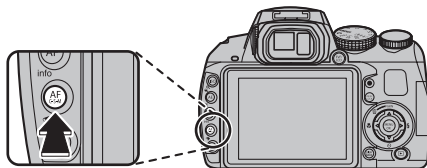

- ① Dynamic range
- ② Image size and quality
- ③ Sensitivity
- ④ Shutter speed/aperture
- ⑤ Film simulation
- ⑥ Flash mode
- ⑦ White balance
- ⑧ Exposure compensation
- ⑨ Frame number
- ⑩ Picture (overexposed areas blink on and off)
- ⑪ Histogram

## Histograms

Histograms show the distribution of tones in the image. Brightness is shown by the horizontal axis, the number of pixels by the vertical axis.

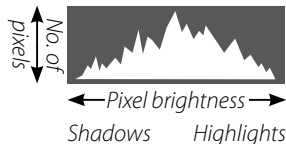

**Optimal exposure:** Pixels are distributed in an even curve throughout the tone range.

**Overexposed:** Pixels are clustered at the right side of the graph.

**Underexposed:** Pixels are clustered at the left side of the graph.





# Image Search

Search for images by various criteria.

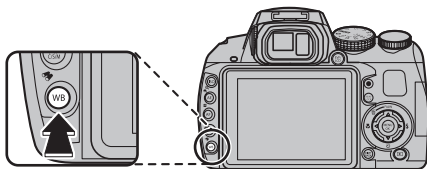

- 1 Press the  button during playback.



- 2 Highlight one of the following options and press **MENU/OK**:

Option	Description
<b>BY DATE</b>	Find all pictures taken on a selected date.
<b>BY FACE</b>	Find all pictures based on specified face information.
<b>BY ★ FAVORITES</b>	Find all pictures with a specified rating (  52).
<b>BY SCENE</b>	Find all pictures that match a selected scene.
<b>BY TYPE OF DATA</b>	Find all still pictures or all movies.
<b>BY UPLOAD MARK</b>	Find all pictures selected for upload to a specified destination (  84).

- 3 Select a search condition. Only pictures that match the search condition will be displayed. To delete or protect selected pictures or to view the selected pictures in a slide show, press **MENU/OK** and choose from the following options:

Option	See page
 <b>ERASE</b>	84
 <b>PROTECT</b>	86
 <b>SLIDE SHOW</b>	85

- 4 To end the search, select **EXIT SEARCH**.

## PhotoBook Assist

Create books from your favorite photos.

### ***Creating a PhotoBook***

**1** Select  **PHOTOBOOK ASSIST** in the playback menu.

**2** Highlight **NEW BOOK**.



**3** Press **MENU/OK** to display the new book dialog.



**4** Choose pictures for the new book.

- **SELECT FROM ALL:** Choose from all the pictures available.



- **SELECT BY IMAGE SEARCH:** Choose from pictures matching selected search conditions ( 57).

#### **Note**

Neither photographs  640 or smaller nor movies can be selected for photobooks.

**5** Scroll through the images and press the selector up to select or deselect the current image for inclusion in the book. To display the current image on the cover, press the selector down.

#### **Note**

The first picture selected automatically becomes the cover image. Press the selector down to select a different picture for the cover.

**6** Press **MENU/OK** to exit when the book is complete.



**7** Highlight **COMPLETE PHOTOBOOK**.

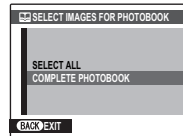

#### **Note**

Choose **SELECT ALL** to select all photos, or all photos matching the specified search conditions, for the book.

**8** Press **MENU/OK**. The new book will be added to the list in the photobook assist menu.



#### Cautions

- Photobooks can contain up to 300 pictures.
- Books that contain no photos are automatically deleted.

#### PhotoBooks

Photobooks can be copied to a computer using the supplied MyFinePix Studio software.

## ***Viewing PhotoBooks***

Highlight a book in the photobook assist menu and press **MENU/OK** to display the book, then press the selector left and right to scroll through the pictures. Press **DISP/BACK** to return to the photobook assist menu.

## ***Editing and Deleting PhotoBooks***



- 1** Display the photobook and press **MENU/OK** to view book edit options. 
- 2** Choose from the following options:
  - **EDIT:** Edit the book as described in “Creating a PhotoBook” on page 58.
  - **ERASE:** Delete the current photobook.
- 3** Follow the on-screen instructions.

## Viewing Panoramas

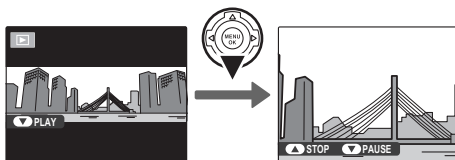
To view a panorama, display in single-frame view and press the selector down.



The following operations can be performed during playback:

Operation	Button	Description
Start/pause playback		<b>Press the selector down</b> to start playback. Press again to pause.
End playback		<b>Press the selector up</b> to end playback.



## Recording Movies

Press **REC** to shoot a movie. During recording, the following indicators will be displayed and sound will be recorded via the built-in microphone (be careful not to cover the microphone during recording).

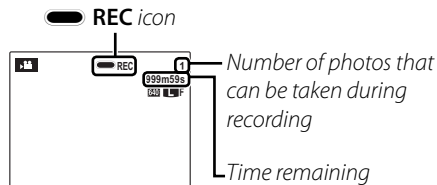
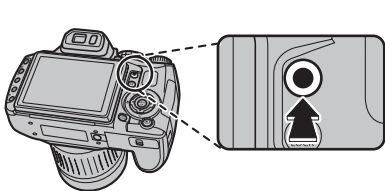

To end recording, press the **REC** button again. Recording ends automatically when the movie reaches maximum length or memory is full.

### Notes

- Zoom can be adjusted while recording is in progress.
- If the subject is poorly lit, the AF-assist lamp may light to assist the focus operation.  
To turn the AF-assist lamp off, select **OFF** for **AF- AF ILLUMINATOR** in the setup menu (📖 96).
- Focus, exposure, and white balance are adjusted automatically throughout recording. The color and brightness of the image may vary from that displayed before recording begins.
- Sounds made by the camera may be recorded.

### Taking Photographs During Recording

Press the shutter button to take a photograph during recording.

#### Notes

- If  is selected for  **IMAGE SIZE**, the picture will be recorded at size .
- The photo is saved separately from the movie and does not appear as part of the movie.



#### Cautions







- Photos can not be taken while a high-speed movie is being recorded.
- The number of photos that can be taken is limited.

#### Cautions

- The indicator lamp lights while movies are being recorded. Do not open the battery chamber during shooting or while the indicator lamp is lit. Failure to observe this precaution could prevent the movie from being played back.
- Vertical or horizontal streaks may appear in movies containing very bright subjects. This is normal and does not indicate a malfunction.
- The temperature of the camera may rise if it is used to record movies for an extended period or if the ambient temperature is high. This is normal and does not indicate a malfunction.

## ***Movie Frame Size***

Before recording, select a frame size using the  **MOVIE MODE** option in the shooting menu ( 82).

Option	Description
 <b>1920</b> (1920 × 1080)	Full HD (High Definition).
 <b>1280</b> (1280 × 720)	High Definition.
 <b>640</b> (640 × 480)	Standard definition.
 <b>640 × 480</b> (80fps)	High speed movie. Sound is not recorded, and focus, exposure, and white balance are not adjusted automatically. Black bands appear at the top and bottom of movies recorded at  <b>320 × 112</b> .
 <b>320 × 240</b> (160fps)	
 <b>320 × 112</b> (320fps)	

## ▶ Viewing Movies

During playback (📖 52), movies are displayed in the monitor as shown at right. The following operations can be performed while a movie is displayed:

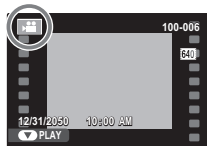

Operation	Description
Start/pause playback	<b>Press the selector down</b> to start playback. Press again to pause. While playback is paused, you can press the selector left or right to rewind or advance one frame at a time.
End playback/delete	<b>Press the selector up</b> to end playback.
Adjust speed	<b>Press the selector left or right</b> to adjust playback speed during playback.
Adjust volume	<b>Press MENU/OK</b> to pause playback and display volume controls. Press the selector up or down to adjust the volume and press <b>MENU/OK</b> to exit. Volume can also be adjusted from the setup menu.

### ▶ Playback Speed

Press the selector left or right to adjust playback speed. Speed is shown by the number of arrows (▶ or ◀).

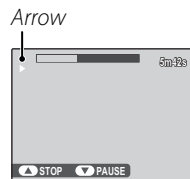

### 📖 Tip: Viewing Movies on a Computer

Copy movies to the computer before viewing.

### ⚠ Caution

Do not cover the speaker during playback.

## Viewing Pictures on TV

Connect the camera to a TV to show pictures to a group.

- 1 Turn the camera off.
- 2 Connect the supplied A/V cable as shown below.

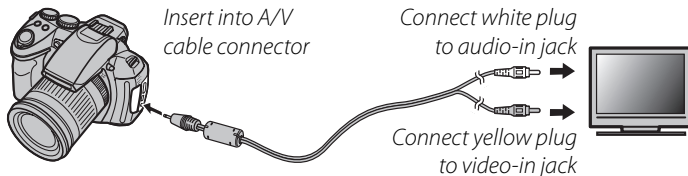

### HDMI

An HDMI cable (available from third-party suppliers; 99) can be used to connect the camera to High Definition (HD) devices (playback only). The USB cable can not be used while an HDMI cable is connected.

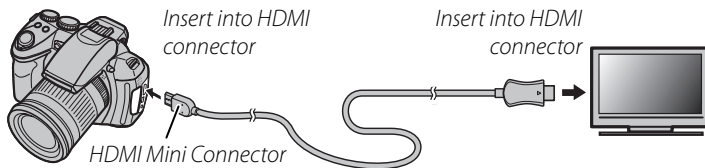

- 3 Tune the television to the video or HDMI input channel. See the documentation supplied with the television for details.
- 4 Turn the camera on and press the  button. The camera monitor turns off and pictures and movies are played back on the TV. Note that the camera volume controls have no effect on sounds played on the TV; use the television volume controls to adjust the volume.

 **Note**

Image quality drops during movie playback.

 **Caution**

When connecting the cable, be sure the connectors are fully inserted.

# Printing Pictures via USB

If the printer supports PictBridge, the camera can be connected directly to the printer and pictures can be printed without first being copied to a computer. Note that depending on the printer, not all the functions described below may be supported.



## Connecting the Camera

- 1 Connect the supplied USB cable as shown and turn the printer on.

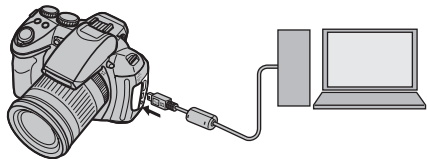

- 2 Turn the camera on and press the button. **USB** will be displayed in the monitor, followed by the PictBridge display shown below at right.

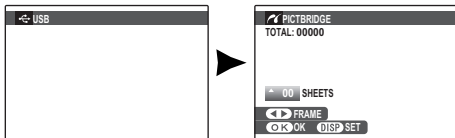

## Printing Selected Pictures

- 1 Press the selector left or right to display a picture you wish to print.
- 2 Press the selector up or down to choose the number of copies (up to 99).
- 3 Repeat steps 1–2 to select additional pictures. Press **MENU/OK** to display a confirmation dialog when settings are complete.

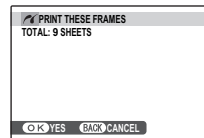

- 4 Press **MENU/OK** to start printing.



**Tip: Printing the Date of Recording**

To print the date of recording on pictures, press **DISP/BACK** in steps 1–2 to display the PictBridge menu (see “Printing the DPOF Print Order,” below). Press the selector up or down to highlight **PRINT WITH DATE** and press **MENU/OK** to return to the PictBridge display (to print pictures without the date of recording, select **PRINT WITHOUT DATE**).

**Note**

If no pictures are selected when the **MENU/OK** button is pressed, the camera will print one copy of the current picture.

**Printing the DPOF Print Order**

To print the print order created with **PRINT ORDER (DPOF)** in the playback menu (89):

- 1 In the PictBridge display, press **DISP/BACK** to open the PictBridge menu.

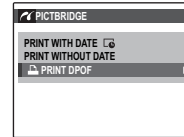

- 2 Press the selector up or down to highlight **PRINT DPOF**.



- 3 Press **MENU/OK** to display a confirmation dialog.

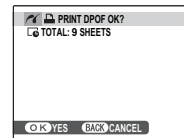

**4** Press **MENU/OK** to start printing.



#### **During Printing**

The message shown at right is displayed during printing. Press **DISP/BACK** to cancel before all pictures are printed (depending on the printer, printing may end before the current picture has printed).

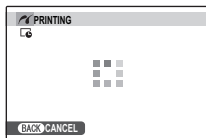

If printing is interrupted, turn the camera off and then on again.

#### **Disconnecting the Camera**

Confirm that "PRINTING" is not displayed in the monitor and turn the camera off. Disconnect the USB cable.

#### **Notes**

- Pictures can be printed from internal memory or a memory card that has been formatted in the camera.
- If the printer does not support date printing, the **PRINT WITH DATE**  option will not be available in the PictBridge menu and the date will not be printed on the pictures in the DPOF print order.
- When pictures are printed via direct USB connection, page size, print quality, and border selections are made using the printer.



## Creating a DPOF Print Order

The  **PRINT ORDER (DPOF)** option in the playback menu can be used to create a digital “print order” for PictBridge-compatible printers (📖 99) or devices that support DPOF.

### DPOF

DPOF (Digital Print Order Format) is a standard that allows pictures to be printed from “print orders” stored in internal memory or on a memory card. The information in the order includes the pictures to be printed, date imprint, and the number of copies of each picture.



### ■ **WITH DATE** / **WITHOUT DATE**

- 1 Select playback mode and press **MENU/OK** to display the playback menu. 
- 2 Highlight  **PRINT ORDER (DPOF)** and press **MENU/OK**. 
- 3 Highlight one of the following options and press **MENU/OK**:
  - **WITH DATE** : Print the date of recording on pictures. 
  - **WITHOUT DATE**: Do not print the date of recording on pictures.
- 4 Press the selector left or right to display a picture you wish to include in or remove from the print order. 

- 5** Press the selector up or down to choose the number of copies (up to 99). To remove a picture from the order, press the selector down until the number of copies is 0.

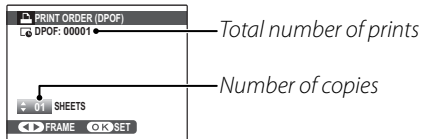

**Tip: Intelligent Face Detection**

If the current picture was created with Intelligent Face Detection, pressing  sets the number of copies to the number of faces detected.

**Note**

When pictures are printed via direct USB connection, page size, print quality, and border selections are made using the printer.

- 6** Repeat steps 4–5 to complete the print order. Press **MENU/OK** to save the print order when settings are complete, or **DISP/BACK** to exit without changing the print order.



- 7** The total number of prints is displayed in the monitor. Press **MENU/OK** to exit.



The pictures in the current print order are indicated by a  icon during playback.



### ← Notes

- Remove the memory card to create or modify a print order for the pictures in internal memory.
- Print orders can contain a maximum of 999 pictures.
- If a memory card is inserted containing a print order created by another camera, the message shown at right will be displayed. Pressing **MENU/OK** cancels the print order; a new print order must be created as described above.

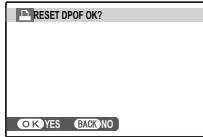

### ■ RESET ALL

To cancel the current print order, select **RESET ALL** in the  **PRINT ORDER (DPOF)** menu. The confirmation shown at right will be displayed; press **MENU/OK** to remove all pictures from the order.

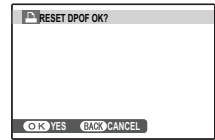

## Viewing Pictures on a Computer

The supplied software can be used to copy pictures to a computer, where they can be stored, viewed, organized, and printed. Before proceeding, install the software as described below. **Do NOT connect the camera to the computer until installation is complete.**

### ***Installing the Software***

Two applications are supplied: MyFinePix Studio for Windows and FinePixViewer for the Macintosh. Installation instructions for Windows are on pages 72–73, those for the Macintosh on pages 74–75.

#### **Windows: Installing MyFinePix Studio**

**1** Confirm that the computer meets the following system requirements:

	Windows 7 <sup>1</sup>	Windows Vista <sup>1</sup>	Windows XP <sup>1</sup>
<b>CPU</b>	3 GHz Pentium 4 or better (2.4 GHz Core 2 Duo or better) <sup>2</sup>		2 GHz Pentium 4 or better (2.4 GHz Core 2 Duo or better) <sup>2</sup>
<b>RAM</b>	1 GB or more		512 MB or more (1 GB or more) <sup>2</sup>
<b>Free disk space</b>	15 GB or more		2 GB or more
<b>Video</b>	<ul style="list-style-type: none"><li>• 1024×768 pixels or more with 24-bit color or better</li><li>• A graphics processing unit (GPU) that supports DirectX 7 or later</li></ul>		
<b>Other</b>	<ul style="list-style-type: none"><li>• Built-in USB port recommended. Operation is not guaranteed with other USB ports.</li><li>• Internet connection (broadband recommended) required to install .NET Framework (if necessary), to use auto update feature, and when performing such tasks as sharing pictures on-line or via e-mail.</li></ul>		

1 Other versions of Windows are not supported. Only pre-installed operating systems are supported; operation is not guaranteed on home-built computers or computers that have been upgraded from earlier versions of Windows.

2 Recommended when displaying HD movies.

- 2 Start the computer. Log in to an account with administrator privileges before proceeding.
- 3 Exit any applications that may be running and insert the installer CD in a CD-ROM drive.

#### **Windows 7/Windows Vista**

If an AutoPlay dialog is displayed, click **SETUP.EXE**. A “User Account Control” dialog will then be displayed; click **Yes** (Windows 7) or **Allow** (Windows Vista).

The installer will start automatically; click **Install MyFinePix Studio** and follow the on-screen instructions to install MyFinePix Studio.

#### **If the Installer Does Not Start Automatically**

If the installer does not start automatically, select **Computer** or **My Computer** from the Start menu, then double-click the **FINEPIX** CD icon to open the FINEPIX CD window and double-click **setup** or **SETUP.EXE**.

- 4 If prompted to install Windows Media Player, DirectX, or .NET Framework, follow the on-screen instructions to complete installation.
- 5 Remove the installer CD from the CD-ROM drive when installation is complete. Store the installer CD in a dry location out of direct sunlight in case you need to re-install the software. The version number is printed at the top of the CD label for reference when updating the software or contacting customer support.

Installation is now complete. Proceed to “Connecting the Camera” on page 76.

## Macintosh: Installing FinePixViewer

**1** Confirm that the computer meets the following system requirements:

<b>CPU</b>	PowerPC or Intel (Core 2 Duo or better) *
<b>OS</b>	Pre-installed versions of Mac OS X version 10.3.9–10.6 (visit <a href="http://www.fujifilm.com/support/digital_cameras/compatibility/">http://www.fujifilm.com/support/digital_cameras/compatibility/</a> for more information)
<b>RAM</b>	256 MB or more (1 GB or more) *
<b>Free disk space</b>	A minimum of 200 MB required for installation with 400 MB available when FinePixViewer is running
<b>Video</b>	800 × 600 pixels or more with thousands of colors or better
<b>Other</b>	Built-in USB port recommended. Operation is not guaranteed with other USB ports.

\* Recommended when displaying HD movies.

- 2** After starting the computer and quitting any applications that may be running, insert the installer CD in a CD-ROM drive and double-click **Installer for Mac OS X**.
- 3** An installer dialog will be displayed; click **Installing FinePixViewer** to start installation. Enter an administrator name and password when prompted and click **OK**, then follow the on-screen instructions to install FinePixViewer. Click **Exit** to quit the installer when installation is complete.

- 4 Remove the installer CD from the CD-ROM drive. Note that you may be unable to remove the CD if Safari is running; if necessary, quit Safari before removing the CD. Store the installer CD in a dry location out of direct sunlight in case you need to re-install the software. The version number is printed at the top of the CD label for reference when updating the software or contacting customer support.
- 5 **Mac OS X 10.5 or earlier:** Open the “Applications” folder, start Image Capture, and select **Preferences...** from the Image Capture application menu. The Image Capture preferences dialog will be displayed; choose **Other...** in the **When a camera is connected, open** menu, then select **FPVBridge** in the “Applications/FinePixViewer” folder and click **Open**. Quit Image Capture.  
**Mac OS X 10.6:** Connect the camera and turn it on. Open the “Applications” folder and start Image Capture. The camera will be listed under **DEVICES**; select the camera and choose **FPVBridge** from the **Connecting this camera opens** menu and click **Choose**. Quit Image Capture.

Installation is now complete. Proceed to “Connecting the Camera” on page 76.

## **Connecting the Camera**

- 1** If the pictures you wish to copy are stored on a memory card, insert the card into the camera (📖 11).

### ← **Note**

Windows users may require the Windows CD when starting the software for the first time.

### ⚠ **Caution**

Loss of power during transfer could result in loss of data or damage to internal memory or the memory card. Insert fresh or fully-charged batteries before connecting the camera.

- 2** Turn the camera off and connect the supplied USB cable as shown, making sure the connectors are fully inserted. Connect the camera directly to the computer; do not use a USB hub or keyboard.

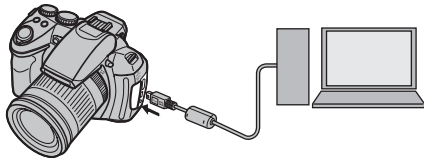

- 3** Turn the camera on and press the **▶** button. MyFinePix Studio or FinePixViewer will start automatically; follow the on-screen instructions to copy pictures to the computer. To exit without copying pictures, click **Cancel**.

### ⚠ **Caution**

If the software does not start automatically, it may not be correctly installed. Disconnect the camera and reinstall the software.

For more information on using the supplied software, start the application and select the appropriate option from the **Help** menu.



### Cautions

- If a memory card containing a large number of images is inserted, there may be a delay before the software starts and you may be unable to import or save images. Use a memory card reader to transfer pictures.
- Make sure that the computer does not display a message stating that copying is in progress and that the indicator lamp is out before turning the camera off or disconnecting the USB cable (if the number of images copied is very large, the indicator lamp may remain lit after the message has cleared from the computer display). Failure to observe this precaution could result in loss of data or damage to internal memory or the memory card.
- Disconnect the camera before inserting or removing memory cards.
- In some cases, it may not be possible to access pictures saved to a network server using the supplied software in the same way as on a standalone computer.
- The user bears all applicable fees charged by the phone company or Internet service provider when using services that require an Internet connection.

### Disconnecting the Camera

After confirming that the indicator lamp is out, follow the on-screen instructions to turn the camera off and disconnect the USB cable.

### Uninstalling the Supplied Software

Only uninstall the supplied software when it is no longer required or before beginning reinstallation. After quitting the software and disconnecting the camera, drag the “FinePixViewer” folder from “Applications” into the Trash and select **Empty Trash** in the **Finder** menu (Macintosh), or open the control panel and use “Programs and Features” (Windows 7/Windows Vista) or “Add or Remove Programs” (Windows XP) to uninstall MyFinePix Studio. Under Windows, one or more confirmation dialogs may be displayed; read the contents carefully before clicking **OK**.

# Using the Menus: Shooting Mode

Use the shooting menus to adjust shooting settings. The options available vary with the shooting mode selected.

## Using the Shooting Menu

- 1 Press **MENU/OK** to display the shooting menu.
- 2 Press the selector up or down to highlight the desired menu item.
- 3 Press the selector right to display options for the highlighted item.
- 4 Press the selector up or down to highlight the desired option.
- 5 Press **MENU/OK** to select the highlighted option.
- 6 Press **DISP/BACK** to exit from the menu.



## Shooting Menu Options

Default values are shown in square brackets [ ].

**EXR MODE** [EXR AUTO]

Choose an option for **EXR** mode (📖 22).

**Adv. MODE** [📖]

Choose an advanced shooting mode (📖 23).

**SCENE POSITION** [SP1:👤] [SP2:▲]

Choose a scene for **SP1/SP2** mode (📖 25).

**ISO** [AUTO (800)]

Control the camera's sensitivity to light (📖 38).

**IMAGE SIZE** [📺 4:3]

Choose the image size and aspect ratio at which pictures are recorded. Large pictures can be printed at large sizes with no drop in quality, while small pictures require less memory, allowing more pictures to be recorded.



## Size Versus Aspect Ratio

### Size

Option	Prints at sizes up to
<b>L</b>	34 × 25 cm (13.5 × 10 in.)
<b>M</b>	24 × 18 cm (9.5 × 7 in.)
<b>S</b>	17 × 13 cm (7 × 5 in.)

### Aspect ratio

**4:3:** Pictures have the same proportions as the camera display.

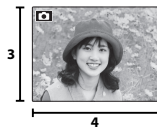

**3:2:** Pictures have the same proportions as a frame of 35 mm film.



**16:9:** Suited for display on High Definition (HD) devices.

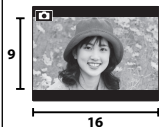

## IMAGE QUALITY

**[N]**

Choose how much image files are compressed.

Option	Description
<b>FINE</b>	Low compression. Select for higher image quality.
<b>NORMAL</b>	High compression. Select this option to store more pictures.

**D-Ring DYNAMIC RANGE [AUTO]**

Control contrast. Higher values are recommended for scenes that include both sunlight and deep shade or for increased contrast with such subjects as sunlight on water, brightly-lit autumn leaves, portraits taken against a blue sky, and white objects or people wearing white; note, however, that mottling may appear in pictures taken at higher values. If **AUTO** is selected, the camera will automatically select values between 100% and 400% in response to shooting conditions.

Option	Description
<b>AUTO</b>	Increase contrast when shooting indoors or under overcast skies. ↑ ↓
<b>R100 100%</b>	
<b>R200 200%</b>	
<b>R400 400%</b>	Reduce loss of detail in highlights and shadows when photographing high-contrast scenes.
<b>R800 800%</b>	
<b>R1600 1600%</b>	

**Note**

**R1600 1600%** and **R800 800%** are available only when **D-RANGE PRIORITY** is selected in **EXR** mode.

**FILM SIMULATION [STD]**

Simulate the effects of different types of film, including sepia and black-and-white.

Option	Description
<b>STD PROVIA/STANDARD</b>	Standard color reproduction. Suited to a wide range of subjects, from portraits to landscapes.
<b>VIVID</b>	A high-contrast palette of saturated colors, suited to nature photographs.
<b>SOFT</b>	A soft-toned palette of less saturated colors.
<b>B&amp;W</b>	Take pictures in black and white.
<b>SEPIA</b>	Take pictures in sepia.

**WB SHIFT**

White balance can be fine-tuned. Adjust the selected color axis (**R-Cy**=Red-Cyan or **B-Ye**=Blue-Yellow) by +3 to -3 in increments of one.

**COLOR [MID]**

Adjust color density (**HIGH/MID/LOW**).

**TONE [STD]**

Adjust contrast (**HARD/STD/SOFT**).

**SHARPNESS [STD]**

Choose whether to sharpen or soften outlines (**HARD/STD/SOFT**).

**NOISE REDUCTION [STD]**

Choose the amount of noise reduction (**HIGH/STD/LOW**).

**ADVANCED ANTI BLUR [OFF]**

Select **ON** to enable advanced anti blur in **EXR AUTO** mode (📖 22).

**FACE DETECTION**

Choose whether the camera automatically detects and sets focus and exposure for human portrait subjects (📖 48).

**FACE RECOGNITION**

Add portrait subjects to the face recognition database. These subjects will be given priority during Intelligent Face Detection, and their names and other information can be viewed during playback (📖 49).

**MOVIE AF MODE**

This option controls how the camera selects the focus area for movies.

Option	Description
<b>CENTER</b>	The camera focuses on the subject in the center of the frame.
<b>CONTINUOUS</b>	The camera continuously adjusts focus to reflect changes in the distance to the subject in the focus frame.

**Note**

Note that in mode, the camera focuses continuously, increasing the drain on the battery, and that the sound of the camera focusing may be audible.

**MOVIE MODE**

Choose a frame size for movies ( 62).

**AE BKT EV STEPS**

Choose the size of the exposure bracketing increment used when (AE bracketing) is selected in continuous shooting mode ( 44).

Choose from increments of  $\pm\frac{1}{3}$ EV,  $\pm\frac{2}{3}$ EV, and  $\pm 1$ EV (note that the camera may not be able to use the selected bracketing increment if the amount of over- or under- exposure exceeds the limits of the exposure metering system).

**FLASH**

Adjust flash brightness. Choose from values between  $+\frac{2}{3}$ EV and  $-\frac{2}{3}$ EV. The default setting is  $\pm 0$ . Note that the desired results may not be achieved depending on shooting conditions and the distance to the subject.

**EXTERNAL FLASH [OFF]**

Choose **ON** when using an optional flash unit (except Fujifilm products) mounted on the camera hot shoe.

**⚠ Cautions**

- The flash may not fully light the subject at speeds faster than  $\frac{1}{1000}$ s.
- Use auto or custom white balance (📖 43).
- If the built-in flash is raised when **ON** is selected for **EXTERNAL FLASH**, the built-in flash will fire once to provide a signal for the optional flash unit to fire.
- External flash units can be used in **P, S, A, M** or **EXR** (🔍 and 📷 only) modes.
- Fujifilm external flash units do not require this setting.

**👉 Notes**

- The camera can be used with flash units that provide aperture adjustment, external metering, and sensitivity control. Some flash units that are designed specifically for other cameras can not be used.
- For information on Fujifilm external flash units, see Accessories from FUJIFILM (📖 100).

**CUSTOM SET**

Save settings for **P, S, A, M** and all **EXR** modes except **EXR AUTO** (📖 22).

**ELECTRONIC LEVEL [OFF]**

This option is useful to correct for camera tilt. When **ON** is selected, 2 lines are displayed across the screen as shown. If the lines stay perfectly overlapped, the camera is leveled.

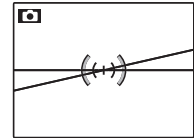

# Using the Menus: Playback Mode

## ***Using the Playback Menu***

- 1** Press the  button to enter playback mode.
- 2** Press **MENU/OK** to display the playback menu.
- 3** Press the selector up or down to highlight the desired menu item.
- 4** Press the selector right to display options for the highlighted item.
- 5** Press the selector up or down to highlight the desired option.
- 6** Press **MENU/OK** to select the highlighted option.



## ***Playback Menu Options***

### **PHOTOBOOK ASSIST**

Create books from your favorite photos ( 58).

### **ERASE**

Delete all or selected pictures ( 55).

### **MARK FOR UPLOAD TO**

Select pictures for upload to YouTube or Facebook using MyFinePix Studio (Windows only).

#### ■ ***Selecting Pictures for Upload***

- 1** Select **YouTube** to choose movies for upload to YouTube, **FACEBOOK** to choose photos and movies for upload to Facebook.
- 2** Press the selector left or right to display pictures and press **MENU/OK** to select or deselect. Press **DISP/BACK** to exit when all the desired pictures are selected.

#### **Notes**

- Only movies can be selected for upload to YouTube.
- During playback, selected pictures are indicated by  **YouTube** or  **FACEBOOK** icons.



### ■ **RESET ALL: Deselecting All Pictures**

Choose **RESET ALL** to deselect all pictures. If the number of pictures affected is very large, a message will be displayed while the operation is in progress. Press **DISP/BACK** to exit before the operation is complete.

### ■ **Uploading Pictures (Windows Only)**

Selected pictures can be uploaded using the **YouTube/Facebook Upload** option in MyFinePix Studio.

*Select with camera*

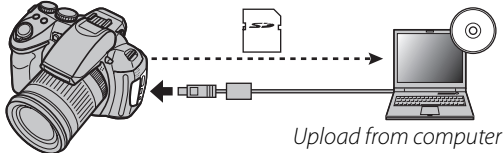

For information on installing MyFinePix Studio and connecting the camera to a computer, see "Viewing Pictures on a Computer" (📖 72).

### 🖼️ **SLIDE SHOW** **[MULTIPLE]**

View pictures in an automated slide show. Choose the type of show and press **MENU/OK** to start. Press **DISP/BACK** at any time during the show to view on-screen help. The show can be ended at any time by pressing **MENU/OK**.

Option	Description
<b>NORMAL</b>	Press selector left or right to go back or skip ahead one frame. Select <b>FADE-IN</b> for fade transitions between frames.
<b>FADE-IN</b>	
<b>NORMAL</b> 📷	As above, except that camera automatically zooms in on faces selected with Intelligent Face detection.
<b>FADE-IN</b> 📷	
<b>MULTIPLE</b>	Display several pictures at once.

#### 👉 **Note**



The camera will not turn off automatically while a slide show is in progress.

## RED EYE REMOVAL

If the current picture is marked with a  icon to indicate that it was taken with Intelligent Face Detection, this option can be used to remove red-eye. The camera will analyze the image; if red-eye is detected, the image will be processed to create a copy with reduced red-eye.

- 1 Display the desired picture.
- 2 Select  **RED EYE REMOVAL** in the playback menu.
- 3 Press **MENU/OK**.

### Notes

- Red-eye may not be removed if the camera is unable to detect a face or the face is in profile. Results may differ depending on the scene. Red-eye can not be removed from pictures that have already been processed using red-eye removal or pictures created with other devices.
- The amount of time needed to process the image varies with the number of faces detected.
- Copies created with  **RED EYE REMOVAL** are indicated by a  icon during playback.

## PROTECT

Protect pictures from accidental deletion.



- 1 Select  **PROTECT** in the playback menu.
- 2 Highlight one of the following options and press **MENU/OK**:
  - **FRAME**: Protect selected pictures. Press the selector left or right to view pictures and press **MENU/OK** to select or deselect. Press **DISP/BACK** when the operation is complete.
  - **SET ALL**: Protect all pictures.
  - **RESET ALL**: Remove protection from all pictures.

### Caution

Protected pictures will be deleted when the memory card or internal memory is formatted ( 93).

** CROP**



Create a cropped copy of the current picture.

- 1** Display the desired picture.
- 2** Select ** CROP** in the playback menu.
- 3** Use the  and  buttons to zoom the image in and out and use the selector to scroll the picture until the desired portion is displayed.
- 4** Press **MENU/OK** to display a confirmation dialog.
- 5** Press **MENU/OK** again to save the cropped copy to a separate file.

** Note**

Larger crops produce larger copies; all copies have an aspect ratio of 4:3. If the size of the final copy will be **640**, **OK** will be displayed in yellow.

** Tip: Intelligent Face Detection**

If the picture was shot with Intelligent Face Detection ( 48),  will be displayed in the monitor. Press the  button to zoom in on the selected face.

** RESIZE**

Create a small copy of the current picture.

- 1** Display the desired picture.
- 2** Select ** RESIZE** in the playback menu.
- 3** Highlight a size and press **MENU/OK** to display a confirmation dialog.
- 4** Press **MENU/OK** to save the resized copy to a separate file.

** Note**

The sizes available vary with the size of the original image.

## IMAGE ROTATE

Rotate pictures taken in tall orientation so that they are displayed in tall orientation in the LCD monitor.





- 1 Display the desired picture.
- 2 Select  **IMAGE ROTATE** in the playback menu.
- 3 Press the selector down to rotate the picture 90° clockwise, up to rotate it 90° counterclockwise.
- 4 Press **MENU/OK**. The picture automatically be displayed in the selected orientation whenever it is played back on the camera.

### Notes

- Protected pictures can not be rotated. Remove protection before rotating pictures (📖 86).
- The camera may not be able to rotate pictures created with other devices.

## COPY

Copy pictures from internal memory to a memory card.

- 1 Select  **COPY** in the playback menu.
- 2 Highlight one of the following options and press the selector right:
  -  **INTERNAL MEMORY** →  **SD CARD**: Copy pictures from internal memory to a memory card.
  -  **SD CARD** →  **INTERNAL MEMORY**: Copy pictures from a memory card to internal memory.
- 3 Highlight one of the following options and press **MENU/OK**:
  - **FRAME**: Copy selected pictures. Press the selector left or right to view pictures and press **MENU/OK** to copy the current picture.
  - **ALL FRAMES**: Copy all pictures.

### Notes

- Copying ends when the destination is full.
- DPOF print information is not copied (📖 69).



## VOICE MEMO

Add a voice memo to the current photograph. Holding the camera at a distance of about 20 cm, face the microphone and press **MENU/OK** to begin recording. Press **MENU/OK** again to end recording (recording ends automatically after 30 seconds).

### Notes

- Voice memos can not be added to movies or protected pictures. Remove protection from pictures before recording voice memos.
- If a voice memo already exists for the current picture, the options will be displayed. Select **RE-REC** to replace the existing memo.

### Playing Voice Memos

Pictures with voice memos are indicated by a  icon during playback. To play the voice memo back, select **PLAY** for  **VOICE MEMO** in the playback menu.

### Notes

- The camera may not play voice memos recorded with other devices.
- Do not cover the speaker during playback.

## ERASE FACE RECOG.

Remove face recognition links from the current image. When this option is selected, the camera will zoom in on an area in the current picture that it has matched with a face in the face recognition database. If the match is not correct, press **MENU/OK** to remove the link to the face recognition database.

### Note

Face recognition links can not be removed from copies with a size of **640** or smaller.

## PRINT ORDER (DPOF)

Select pictures for printing on DPOF- and Pict-Bridge-compatible devices ( 67).

## **DISP. ASPECT**

Choose how High Definition (HD) devices display pictures with an aspect ratio of 4 : 3 (this option is available only when an HDMI cable is connected). Select **16:9** to display the image so that it fills the screen with its top and bottom cropped out, **4:3** to display the entire image with black bands at either side.

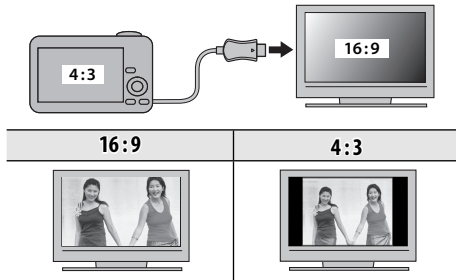

### **Note**

Photographs with an aspect ratio of 16 : 9 are displayed full screen, those with an aspect ratio of 3 : 2 in a black frame.

# The Setup Menu

## Using the Setup Menu

### 1 Display the setup menu.

1.1 Press **MENU/OK** to display the menu for the current mode.



1.2 Press the selector left to highlight a left tab.



1.3 Press the selector up or down to select **SET**.  
The setup menu appears.

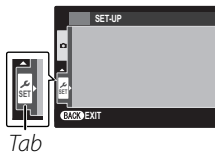

### 2 Adjust settings.

2.1 Press the selector right to activate the setup menu.



2.2 Press the selector up or down to highlight a menu item.



2.3 Press the selector right to display options for the highlighted item.



2.4 Press the selector up or down to highlight an option.



2.5 Press **MENU/OK** to select the highlighted option.



2.6 Press **DISP/BACK** to exit from the menu.



## Setup Menu Options

Default values are shown in square brackets [ ].



### **DATE/TIME**





Set the camera clock ( 14).

### **TIME DIFFERENCE** [

Switch the camera clock instantly from your home time zone to the local time at your destination when traveling. To specify the difference between local time and your home time zone:

- 1 Highlight  **LOCAL** and press the selector right.
- 2 Use the selector to choose the time difference between local time and your home time zone in increments of 15 minutes.
- 3 Press **MENU/OK**.



To switch between local time and your home time zone, highlight  **LOCAL** or  **HOME** and press **MENU/OK**.

Option	Description
 <b>HOME</b>	Switch to the time currently selected for  <b>DATE/TIME</b> (see above).
 <b>LOCAL</b>	Switch to local time. If this option is selected,  and the time and date will be displayed in yellow for three seconds each time the camera is turned on.

### **言語/LANG.**

Choose a language ( 14).

### **SILENT MODE** [**OFF**]

Select **ON** to disable the speaker, flash, and AF-assist illuminator in situations in which camera sounds or lights may be unwelcome (note that the flash will still fire in   mode).



**RESET**

Reset all settings except **DATE/TIME**, **TIME DIFFERENCE**, **BACKGROUND COLOR**, and **VIDEO SYSTEM** to default values.

- 1 Highlight **RESET** and press the selector right to display a confirmation dialog.
- 2 Highlight **OK** and press **MENU/OK**.

**FORMAT**

If a memory card is inserted in the camera, this option will format the memory card. If no memory card is inserted, this option will format internal memory. Select **OK** to begin formatting.

**Cautions**

- All data—including protected pictures—will be deleted from the memory card or internal memory. Be sure important files have been copied to a computer or other storage device.
- Do not open the battery-chamber cover during formatting.

**IMAGE DISP. [1.5 SEC]**

Choose how long pictures are displayed in the LCD monitor after shooting.

Option	Description
<b>3 SEC</b>	Pictures are displayed for three seconds ( <b>3 SEC</b> ) or 1.5 seconds ( <b>1.5 SEC</b> ).
<b>1.5 SEC</b>	Colors may differ slightly from those in the final image.
<b>ZOOM (CONTINUOUS)</b>	Pictures are displayed until the <b>MENU/OK</b> button is pressed.
<b>OFF</b>	Pictures are not displayed after shooting.

**Note**

**OFF** has no effect in continuous shooting mode.

**[No.] FRAME NO.****[CONT.]**

New pictures are stored in image files named using a four-digit file number assigned by adding one to the last file number used. The file number is displayed during playback as shown at right. **[No.] FRAME NO.** controls whether file numbering is reset to 0001 when a new memory card is inserted or the current memory card or internal memory is formatted.

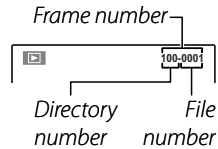

Option	Description
<b>CONTINUOUS</b>	Numbering continues from the last file number used or the first available file number, whichever is higher. Choose this option to reduce the number of pictures with duplicate file names.
<b>RENEW</b>	Numbering is reset to 0001 after formatting or when a new memory card is inserted.

**← Notes**

- If the frame number reaches 999-9999, the shutter release will be disabled (📖 111).
- Selecting **[+] RESET** (📖 93) sets **[No.] FRAME NO.** to **CONTINUOUS** but does not reset the file number.
- Frame numbers for pictures taken with other cameras may differ.

**[Speaker] OPERATION VOL.****[Speaker]**

Adjust the volume of the sounds produced when camera controls are operated. Choose **[Speaker] OFF** (mute) to disable control sounds.

**[Speaker] SHUTTER VOLUME****[Speaker]**

Adjust the volume of the sounds produced when the shutter is released. Choose **[Speaker] OFF** (mute) to disable the shutter sound.

**[Speaker] SHUTTER SOUND****[Speaker]**

Choose the sound made by the shutter.

**[M] PLAYBACK VOLUME [7]**

Adjust the volume for movie and voice memo playback.

**[S] LCD BRIGHTNESS [0]**

Control the brightness of the display.

**[FPS] EVF/LCD MODE [50 fps]**

Choose **30 fps** to increase battery life, **50 fps** for improved display quality.

**[OFF] AUTO POWER OFF [2 MIN]**

Choose the length of time before the camera turns off automatically when no operations are performed. Shorter times increase battery life; if **OFF** is selected, the camera must be turned off manually. Note that in some situations the camera turns off automatically even when **OFF** is selected.

**[ON] QUICK START MODE [OFF]**

Allow the camera to restart in a fast manner after turned off (**24MIN/10 MIN/OFF**). After specified time has passed, the camera will discontinue this option.

**[W] Caution**

This option will increase drain on the battery.

**[DUAL IS MODE] [1]**

Choose whether image stabilization is performed at all times when the camera is in shooting mode (**1 CONTINUOUS**), or only when the shutter button is pressed halfway (**2 SHOOTING ONLY**). Choose **OFF** to turn image stabilization off when using a tripod.

**[EYE] RED EYE REMOVAL [ON]**

Choose **ON** to remove red-eye effects caused by the flash when shooting with Intelligent Face Detection.

**← Notes**

- Red-eye reduction is performed only when a face is detected.
- Red-eye removal is not available with RAW images.

**[AF] AF ILLUMINATOR [ON]**

If **ON** is selected, the AF-assist illuminator will light to assist autofocus.

**[W] Cautions**

- The camera may be unable to focus using the AF-assist illuminator in some cases. If the camera is unable to focus in macro mode, try increasing the distance to the subject.
- Avoid shining the AF-assist illuminator directly into your subject's eyes.

**[AE-L] AE/AF-LOCK MODE [P]**

If **AE&AF ON WHEN PRESSING** is selected, exposure and/or focus will lock while the **AE/AF LOCK** button is pressed. If **AE&AF ON/OFF SWITCH** is selected, exposure and/or focus will lock while the **AE/AF LOCK** button is pressed and remain locked until the button is pressed again (📖 32).

**[AE-L] AE/AF-LOCK BUTTON [AE-L]**

Choose whether the **AE/AF LOCK** button locks only exposure, only focus, or both exposure and focus (**AE-L / AF-L / AE+AF**).

**[RAW] RAW [OFF]**

Choose **RAW+JPEG** or **RAW** to record RAW pictures (note that because RAW data are not processed on the camera, RAW pictures must be copied to a computer for processing). If **RAW+JPEG** is selected, JPEG copies will also be recorded. Choose **OFF** to record pictures in JPEG format only.

**← Notes**

- To convert RAW files for display on a computer, use the supplied RAW File Converter software.
- Press the **RAW** button to temporarily change the recording format that has been set (📖 18).

**⚠ Cautions**

- RAW pictures cannot be recorded to internal memory. Insert a memory card.
- Crop, resize, and red-eye removal options are not available with RAW images during playback. The maximum zoom available when viewing RAW images is 3.2X.

**🔍 FOCUS CHECK [ON]**

If **ON** is selected, the image will be magnified in the display to assist focus when the focus ring is rotated in manual focus mode (📖 41). The camera must be in manual focus mode.

**📁 SAVE ORG IMAGE [OFF]**

Choose **ON** to save unprocessed copies of pictures taken using **👁 RED EYE REMOVAL**, **📷 PRO LOW-LIGHT MODE**, or **🔍 PRO FOCUS MODE**.

**🔄 AUTOROTATE PB [ON]**

Choose **ON** to automatically rotate “tall” (portrait-orientation) pictures during playback.

**🎨 BACKGROUND COLOR**

Choose a color scheme.

**📏 GUIDANCE DISPLAY [ON]**

Choose whether to display tool tips.

**📺 VIDEO SYSTEM**

Choose a video mode for connection to a TV.

Option	Description
NTSC	Select this mode for connection to video devices in North America, the Caribbean, parts of Latin America, and some East Asian countries.
PAL	Select this mode for connection to video devices in the United Kingdom and much of Europe, Australia, New Zealand, and parts of Asia and Africa.



## **CUSTOM RESET**

Reset all settings for mode **C**. A confirmation dialog will be displayed, press the selector up or down to highlight **OK** and press **MENU/OK**.

## **BATTERY TYPE**

Specify the type of battery used in the camera ( 9).

## **DISCHARGE (Ni-MH Batteries Only)**

The capacity of rechargeable Ni-MH batteries may be temporarily reduced when new, after long periods of disuse, or if they are repeatedly recharged before being fully discharged. Capacity can be increased by repeatedly discharging the batteries using the  **DISCHARGE** option and recharging them in a battery charger (sold separately). Do not use  **DISCHARGE** with non-rechargeable batteries, and note that the batteries will not discharge if the camera is powered by an optional AC power adapter and DC coupler.

- 1** Selecting  **DISCHARGE** displays a confirmation dialog. Press **MENU/OK**.
- 2** Select **OK**.
- 3** Press **MENU/OK** to begin discharging the batteries. When the batteries are fully discharged, the battery level indicator will blink red and the camera will turn off. To cancel the process before the batteries are fully discharged, press **DISP/BACK**.



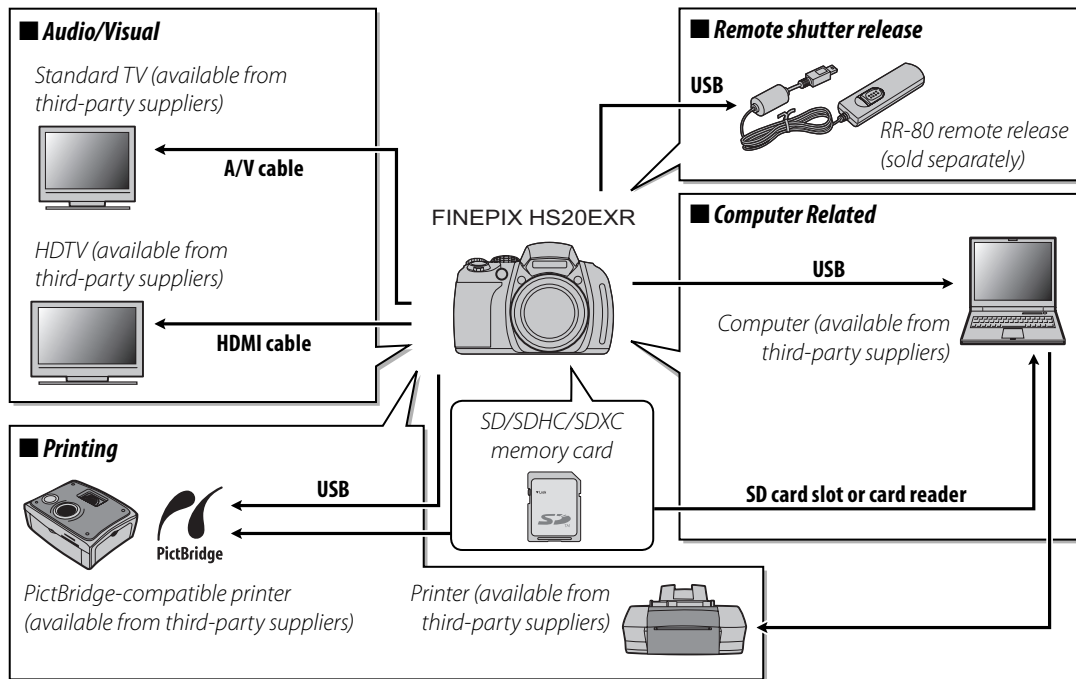

## Optional Accessories

The camera supports a wide range of accessories from FUJIFILM and other manufacturers.

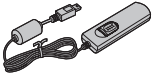

## ***Accessories from FUJIFILM***

The following optional accessories are available from FUJIFILM. For the latest information on the accessories available in your region, check with your local FUJIFILM representative or visit [http://www.fujifilm.com/products/digital\\_cameras/index.html](http://www.fujifilm.com/products/digital_cameras/index.html).

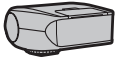
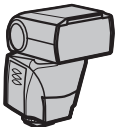
<b>AC power adapter</b>	<b>AC-5VX</b> (requires CP-04 DC coupler)	Use for extended playback or when copying pictures to a computer (shape of adapter and plug vary with region of sale).	
<b>DC coupler</b>	<b>CP-04</b>	Connect the AC-5VX AC power adapter to the camera.	
<b>Remote release</b>	<b>RR-80</b>	Use to reduce camera shake or keep the shutter open during a time exposure.	
<b>Lens hood</b>	<b>LH-HS10</b>	Use to protect the lens and block light to prevent glare and lens flare.	
<b>Shoe Mount Flash</b>	<b>EF-20</b>	Hot-shoe clip-on flash, guide number: 20 (ISO 100), compatible with i-TTL, bounce capability: up to 90°, power source: 2 AA-size 1.5V batteries	
<b>Shoe Mount Flash</b>	<b>EF-42</b>	Hot-shoe clip-on flash, guide number: up to 42 (ISO 100), auto zoom: 24-105mm (equivalent to 135 format), compatible with i-TTL, bounce capability: up to 90°, power source: 4 AA-size 1.5V batteries Set "Format setting" to "35 mm" when using EF-42 and FINEPIX HS-20EXR.	



# Caring for the Camera

To ensure continued enjoyment of the product, observe the following precautions.

## Storage and Use

If the camera will not be used for an extended period, remove the battery and memory card. Do not store or use the camera in locations that are:

- exposed to rain, steam, or smoke
- very humid or extremely dusty
- exposed to direct sunlight or very high temperatures, such as in a closed vehicle on a sunny day
- extremely cold
- subject to strong vibration
- exposed to strong magnetic fields, such as near a broadcasting antenna, power line, radar emitter, motor, transformer, or magnet
- in contact with volatile chemicals such as pesticides
- next to rubber or vinyl products

## ■ *Water and Sand*

Exposure to water and sand can also damage the camera and its internal circuitry and mechanisms. When using the camera at the beach or seaside, avoid exposing the camera to water or sand. Do not place the camera on a wet surface.

## ■ *Condensation*

Sudden increases in temperature, such as occur when entering a heated building on a cold day, can cause condensation inside the camera. If this occurs, turn the camera off and wait an hour before turning it on again. If condensation forms on the memory card, remove the card and wait for the condensation to dissipate.

## Cleaning

Use a blower to remove dust from the lens and monitor, then gently wipe with a soft, dry cloth. Any remaining stains can be removed by wiping gently with a piece of FUJIFILM lens-cleaning paper to which a small amount of lens-cleaning fluid has been applied. Care should be taken to avoid scratching the lens or monitor. The camera body can be cleaned with a soft, dry cloth. Do not use alcohol, thinner, or other volatile chemicals.

## Traveling

Keep the camera in your carry-on baggage. Checked baggage may suffer violent shocks that could damage the camera.

# Troubleshooting







## Power and Battery

Problem	Possible cause	Solution	Page
The camera does not turn on.	The batteries are exhausted.	Insert fresh or fully-charged spare batteries.	8
	The batteries are not in the correct orientation.	Re-insert the batteries in the correct orientation.	8
	The battery-chamber cover is not latched.	Latch the battery-chamber cover.	9
	The AC power adapter and DC coupler are not connected properly.	Make sure that the AC power adapter and DC coupler are properly connected.	—
	The camera has been left for an extended period with no batteries inserted and the AC power adapter/DC coupler unplugged.	After inserting the batteries or connecting the AC power adapter/DC coupler, wait a few moments before turning the camera on.	—
Power supply The batteries run down quickly.	The batteries are cold.	Warm the batteries by placing them in a pocket or other warm place and re-insert them in the camera immediately before taking a picture.	vi
	There is dirt on the battery terminals.	Clean the terminals with a soft, dry cloth.	—
	The camera is in <b>EXR</b> mode.	Select another shooting mode.	21
	The batteries are new, have been left unused for an extended period, or have been re-charged without first being fully discharged (rechargeable Ni-MH batteries only).	Discharge Ni-MH batteries using the <b>DISCHARGE</b> option and recharge them in a battery charger (sold separately). If the batteries do not hold a charge after repeated discharging and recharging, they have reached the end of their service life and must be replaced.	98
	<b>AF-C</b> is selected for focus mode.	Select a different focus mode.	41
The camera turns off suddenly.	The batteries are exhausted.	Insert fresh or fully-charged spare batteries.	8
	The AC power adapter or DC coupler has been disconnected.	Make sure that the AC power adapter and DC coupler are properly connected.	—

## Menus and Displays

Problem	Possible cause	Solution	Page
Menus and displays are not in English.	English is not selected for the  言語/LANG.	Select <b>ENGLISH</b> .	14, 92

## Shooting

Problem	Possible cause	Solution	Page	
Taking pictures	Memory is full.	Insert a new memory card or delete pictures.	10, 55	
	Memory is not formatted.	Format the memory card or internal memory.	93	
	There is dirt on the memory card contacts.	Clean the contacts with a soft, dry cloth.	—	
	The memory card is damaged.	Insert a new memory card.	10	
	The batteries are exhausted.	Insert fresh or fully-charged spare batteries.	8	
The camera has turned off automatically.		Turn the camera on.	13	
	The monitor goes dark after shooting.	The flash has fired.	The monitor may darken while the flash charges. Wait for the flash to charge.	34
Focus	The camera does not focus.	The subject is close to the camera.	Select macro mode.	33
		The subject is far away from the camera.	Cancel macro mode.	
		The subject is not suited to autofocus.	Use focus lock.	31
EXR AUTO	Pictures are not the same size.	 is selected for  <b>IMAGE SIZE</b> in 	If <b>AUTO</b> is selected for  <b>IMAGE SIZE</b> in  mode, the camera will optimize not only sensitivity and other settings, but also image size. To record all pictures at the same size, choose another shooting mode or select another option for  <b>IMAGE SIZE</b> .	21, 78



	<b>Problem</b>	<b>Possible cause</b>	<b>Solution</b>	<b>Page</b>
Intelligent Face Detection	Face detection not available.	Intelligent Face Detection is not available in the current shooting mode.	Choose a different shooting mode.	21
	No face is detected.	The subject's face is obscured by sunglasses, a hat, long hair, or other objects.	Remove the obstructions.	48
		The subject's face occupies only a small area of the frame.	Change the composition so that the subject's face occupies a larger area of the frame.	
		The subject's head is tilted or horizontal.	Ask the subject to hold their head straight.	
		The camera is tilted.	Hold the camera straight.	16
		The subject's face is poorly lit.	Shoot in bright light.	—
Wrong subject selected.	The selected subject is closer to the center of the frame than the main subject.	Recompose the picture or turn face detection off and frame the picture using focus lock.	41, 48	
Close-ups	Macro mode is not available.	Macro mode is not available in the current shooting mode.	Choose a different shooting mode.	21, 33
Flash	The flash does not fire.	The flash is lowered.	Raise the flash.	34
		The flash is charging.	Wait for the flash to charge.	34
		The flash is not available in the current shooting mode.	Choose a different shooting mode.	21
		The batteries are exhausted.	Insert fresh or fully-charged spare batteries.	8
		The camera is in super macro or continuous shooting mode.	Turn super macro and continuous shooting modes off.	33, 44
		The camera is in silent mode.	Turn silent mode off.	18
	Flash mode not available.	The desired flash mode is not available in the current shooting mode.	Choose a different shooting mode.	21
		The camera is in silent mode.	Turn silent mode off.	18
	The flash does not fully light the subject.	The subject is not in range of the flash.	Position the subject in range of the flash.	115
The flash window is obstructed.		Hold the camera correctly.	16	
Fast shutter speed selected.		Choose a slower shutter speed.	29, 30	

	<b>Problem</b>	<b>Possible cause</b>	<b>Solution</b>	<b>Page</b>
Problem images	Pictures are blurred.	The lens is dirty.	Clean the lens.	101
		The lens is blocked.	Keep objects away from the lens.	16
		<b>!AF</b> is displayed during shooting and the focus frame is displayed in red.	Check focus before shooting.	109
		<b>!</b> is displayed during shooting.	Use the flash or a tripod.	34
	Pictures are mottled.	A slow shutter speed is selected at high temperatures.	This is normal and does not indicate a malfunction.	—
		The camera has been used continuously at high temperatures or a temperature warning is displayed.	Turn the camera off and wait for it to cool down.	—
Recording	Pictures are not recorded.	Power was interrupted during shooting.	Turn the camera off before connecting the AC power adapter/DC coupler. Leaving the camera on can result in corrupted files or damage to the memory card or internal memory.	—

## Playback

	<b>Problem</b>	<b>Possible cause</b>	<b>Solution</b>	<b>Page</b>
Pictures	Pictures are grainy.	The pictures were taken with a different make or model of camera.	—	—
	Playback zoom unavailable.	The picture has been saved at 640, or is from another make or model of camera.	—	53
Audio	No sound in voice memo and movie playback.	The camera is in silent mode.	Turn silent mode off.	18
		Playback volume is too low.	Adjust playback volume.	95
		The microphone was obstructed.	Hold the camera correctly during recording.	61, 89
		The speaker is obstructed.	Hold the camera correctly during playback.	63, 89
Deletion	Selected pictures not deleted.	Some of the pictures selected for deletion are protected.	Remove protection using the device with which it was originally applied.	86
Frame no.	File numbering is unexpectedly reset.	The battery-chamber cover was opened while the camera was on.	Turn the camera off before opening the battery-chamber cover.	13

**Connections**

	<b>Problem</b>	<b>Possible cause</b>	<b>Solution</b>	<b>Page</b>
TV	Monitor is off.	The camera is connected to a TV.	View pictures on the TV.	64
	No picture or sound.	The camera is not properly connected.	Connect the camera correctly.	64
		An A/V cable was connected during movie playback.	Connect the camera once movie playback has ended.	63, 64
		Input on the television is set to "TV".	Set input to "VIDEO".	—
		The camera is not set to the correct video standard.	Match the camera  <b>VIDEO SYSTEM</b> setting to the TV.	97
	The volume on the television is too low.	Adjust the volume.	—	
No color.	The camera is not set to the correct video standard.	Match the camera  <b>VIDEO SYSTEM</b> setting to the TV.	97	
Computer	The computer does not recognize the camera.	The camera is not properly connected.	Connect the camera correctly.	76
PictBridge	Pictures can not be printed.	The camera is not properly connected.	Connect the camera correctly.	66
		The printer is off.	Turn the printer on.	—
	Only one copy is printed. The date is not printed.	The printer is not PictBridge-compatible.	—	—









**Miscellaneous**



<b>Problem</b>	<b>Possible cause</b>	<b>Solution</b>	<b>Page</b>
Nothing happens when the shutter button is pressed.	Temporary camera malfunction.	Remove and reinsert the batteries or disconnect and reconnect the AC power adapter/DC coupler.	8
	The batteries are exhausted.	Insert fresh or fully-charged spare batteries.	8
The camera does not function as expected.	Temporary camera malfunction.	Remove and reinsert the batteries or disconnect and reconnect the AC power adapter/DC coupler. If the problem persists, contact your FUJIFILM dealer.	8
I want to use an AC power adapter and DC coupler overseas.	Check the label on the AC power adapter.	The AC power adapter can be used with voltages of 100–240V. Consult your travel agent for information on plug adapters.	—
No sound.	The camera is in silent mode.	Turn silent mode off.	18

















# Warning Messages and Displays

The following warnings are displayed in the monitor:

Warning	Description	Solution
 (red)	Batteries are low.	Insert fresh or fully-charged spare batteries.
 (blinks red)	Batteries are exhausted.	
	Slow shutter speed. Picture may be blurred.	Use the flash or mount the camera on a tripod.
<b>!AF</b> (displayed in red with red focus frame)	The camera can not focus.	<ul style="list-style-type: none"> <li>• Use focus lock to focus on another subject at the same distance, then recompose the picture ( 31).</li> <li>• Use macro mode to focus when taking close-ups.</li> </ul>
Aperture or shutter speed shown in red	The subject is too bright or too dark. The picture will be over- or under-exposed.	If the subject is dark, use the flash.
<b>FOCUS ERROR</b>	Camera malfunction.	Turn the camera off and then on again, taking care not to touch the lens. If the message persists, contact a FUJIFILM dealer.
<b>TURN OFF THE CAMERA AND TURN ON AGAIN</b>		
<b>LENS CONTROL ERROR</b>		
<b>CARD NOT INITIALIZED</b>	The memory card or internal memory is not formatted or the memory card was formatted in a computer or other device.	Format the memory card or internal memory using the  <b>FORMAT</b> option in the camera setup menu (  93).
	The memory card contacts require cleaning.	Clean the contacts with a soft, dry cloth. If the message is repeated, format the memory card (  93). If the message persists, replace the memory card.
	Camera malfunction.	Contact a FUJIFILM dealer.
<b>PROTECTED CARD</b>	The memory card is locked.	Unlock the memory card (  10).

Warning	Description	Solution
BUSY	The memory card is incorrectly formatted.	Use the camera to format the memory card (📖 93).
	The camera temperature is too high. If no action is taken, the camera will turn off automatically.	Turn the camera off and wait for it to cool.
CARD ERROR	The memory card is not formatted for use in the camera.	Format the memory card (📖 93).
	The memory card contacts require cleaning or the memory card is damaged.	Clean the contacts with a soft, dry cloth. If the message is repeated, format the memory card (📖 93). If the message persists, replace the memory card.
	Incompatible memory card.	Use a compatible memory card.
	Camera malfunction.	Contact a FUJIFILM dealer.
 MEMORY FULL	The memory card or internal memory is full and pictures can not be recorded or copied.	Delete pictures or insert a memory card with more free space.
 MEMORY FULL		
INTERNAL MEMORY IS FULL INSERT A NEW CARD		
WRITE ERROR	Memory card error or connection error.	Re-insert the memory card or turn the camera off and then on again. If the message persists, contact a FUJIFILM dealer.
	Not enough memory remaining to record additional pictures.	Delete pictures or insert a memory card with more free space.
	The memory card or internal memory is not formatted.	Format the memory card or internal memory (📖 93).
READ ERROR	The file is corrupt or was not created with the camera.	The file can not be played back.
	The memory card contacts require cleaning.	Clean the contacts with a soft, dry cloth. If the message is repeated, format the memory card (📖 93). If the message persists, replace the memory card.
	Camera malfunction.	Contact a FUJIFILM dealer.

Warning	Description	Solution
FRAME NO. FULL	The camera has run out of frame numbers (current frame number is 999-9999).	Format the memory card and select <b>RENEW</b> for the  <b>FRAME NO.</b> option in the  <b>SET-UP</b> menu. Take a picture to reset frame numbering to 100-0001, then return to the  <b>FRAME NO.</b> menu and select <b>CONTINUOUS</b> .
TOO MANY FRAMES	A search has returned more than 30,000 results.	Choose a search that returns fewer results.
	More than 999 images are selected for deletion.	Choose fewer images.
PROTECTED FRAME	An attempt was made to add a voice memo to or delete a protected picture.	Remove protection before adding voice memos to or deleting pictures.
 ERROR	Voice memo file is corrupt.	The voice memo can not be played back.
	Camera malfunction.	Contact a FUJIFILM dealer.
 CAN NOT CROP	An attempt was made to crop a  picture.	These pictures can not be cropped.
CAN NOT CROP	The picture selected for cropping is damaged or was not created with the camera.	
 CANNOT EXECUTE	An attempt was made to create a resized copy at a size equal to or larger than the original.	Choose a smaller size.
 CANNOT EXECUTE		
 CANNOT EXECUTE		
DPOF FILE ERROR	The DPOF print order on the current memory card contains more than 999 images.	Copy the pictures to internal memory and create a new print order.
CAN NOT SET DPOF	The picture can not be printed using DPOF.	—
 CAN NOT SET DPOF	Movies can not be printed using DPOF.	—
CAN NOT ROTATE	The picture is protected.	Remove protection before rotating pictures.
 CAN NOT ROTATE	Movies can not be rotated.	—
NO CARD	No memory card inserted when  <b>COPY</b> is selected.	Insert a memory card.

Warning	Description	Solution
 NO IMAGE	The source selected for  COPY contains no images.	Select a different source.
 NO IMAGE		
PRESS AND HOLD THE DISP BUTTON TO DEACTIVATE SILENT MODE	An attempt was made to adjust the volume with the camera in silent mode.	Exit silent mode before adjusting the volume.
COMMUNICATION ERROR	A connection error occurred while pictures were being printed or copied to a computer or other device.	Confirm that the device is turned on and that the USB cable is connected.
PRINTER ERROR	Printer out of paper or ink, or other printer error.	Check printer (see printer manual for details). To resume printing, turn the printer off and then turn it back on.
PRINTER ERROR RESUME?		Check printer (see printer manual for details). If printing does not resume automatically, press <b>MENU/OK</b> to resume.
CAN NOT BE PRINTED	An attempt was made to print a movie, a picture not created with the camera, or a picture in a format not supported by the printer.	Movies and some pictures created with other devices can not be printed. If the picture was created with the camera, check the printer manual to confirm that the printer supports the JFIF-JPEG or Exif-JPEG format. If it does not, the pictures can not be printed.

# Internal Memory/Memory Card Capacity

The following table shows the recording time or number of pictures available at different image sizes. All figures are approximate; file size varies with the scene recorded, producing wide variations in the number of files that can be stored. The number of exposures or length remaining may not diminish at an even rate. A limited number of test pictures can be taken when no memory card is inserted.

Medium		Internal memory (approx. 20 MB)		4 GB		8 GB	
		FINE	NORMAL	FINE	NORMAL	FINE	NORMAL
Photographs		3	5	630	1000	1260	2020
		4	6	840	1330	1690	2670
		4	10	990	1960	2000	3950
		6	13	1330	2630	2670	5290
		10	20	1990	3870	4010	7770
		19	29	3750	5630	7540	11310
Movie		11 sec.		38 min.		76 min.	
		14 sec.		49 min.		99 min.	
		34 sec.		115 min.		232 min.	
		26 sec.		86 min.		172 min.	
		53 sec.		172 min.		345 min.	
		26 sec.		86 min.		172 min.	

1 Use a CLASS 4 card or better. Individual movies can not exceed 29 minutes in length.







2 Individual movies can not exceed 115 minutes in length.

3 Use a CLASS 4 card or better. Individual movies can not exceed 30 seconds in length.

## Temperature Warning

The camera will turn off automatically before its temperature or the temperature of the battery rise above safe limits. Pictures taken when a temperature warning is displayed may exhibit higher levels of "noise" (mottling). Turn the camera off and wait for it to cool before turning it on again (105, 110).

# Specifications

System	
<b>Model</b>	Digital Camera FinePix HS20EXR
<b>Effective pixels</b>	16 million
<b>Image sensor</b>	½-in., EXR CMOS with primary color filter
<b>Storage media</b>	• Internal memory (approx. 20 MB) • SD/SDHC/SDXC memory cards
<b>File system</b>	Compliant with Design Rule for Camera File System (DCF), Exif 2.3, and Digital Print Order Format (DPOF)
<b>File format</b>	• <b>Still pictures:</b> Exif 2.3 JPEG (compressed); RAW (original RAF format, special-purpose software required); RAW+JPEG available • <b>Movies:</b> MOV (H.264) • <b>Audio:</b> WAV
<b>Image size (pixels)</b>	• <b>L 4:3:</b> 4,608 × 3,456 • <b>L 3:2:</b> 4,608 × 3,072 • <b>L 16:9:</b> 4,608 × 2,592 • <b>M 4:3:</b> 3,264 × 2,448 • <b>M 3:2:</b> 3,264 × 2,176 • <b>M 16:9:</b> 3,264 × 1,840 • <b>S 4:3:</b> 2,304 × 1,728 • <b>S 3:2:</b> 2,304 × 1,536 • <b>S 16:9:</b> 1,920 × 1,080 •  <b>MOTION PANORAMA 360:</b> 1,624 × 11,520 (tall)/11,520 × 1,080 (wide) •  <b>MOTION PANORAMA 180:</b> 1,624 × 5,760 (tall)/5,760 × 1,080 (wide) •  <b>MOTION PANORAMA 120:</b> 1,624 × 3,840 (tall)/3,840 × 1,080 (wide)
<b>Lens</b>	Fujinon 30× optical zoom lens, F/2.8 (wide angle)–5.6 (telephoto)
<b>Focal length</b>	f=4.2 mm–126.0 mm (35-mm format equivalent: 24 mm–720 mm)
<b>Aperture</b>	F2.8–F11 (wide angle)/F5.6–F11 (telephoto) in increments of ½ EV; can be set manually or automatically
<b>Focus range (distance from front of lens)</b>	• Approx. 50 cm (1.6 ft.)–infinity (wide angle); 3 m (9.8 ft.)–infinity (telephoto) • <b>Macro:</b> approx. 10 cm–3 m/0.3 ft.–9.8 ft. (wide angle); 2 m–5 m/6.6 ft.–16.4 ft. (telephoto) • <b>Super macro:</b> approx. 1 cm–1 m/0.4 in.–3.3 ft.
<b>Sensitivity</b>	Standard output sensitivity equivalent to ISO 100, 200, 400, 800, 1600, 3200, 6400 (image size <b>M</b> or <b>S</b> ), 12800 (image size <b>S</b> ); <b>AUTO, AUTO (400), AUTO (800), AUTO (1600), AUTO (3200)</b>
<b>Metering</b>	256-segment through-the-lens (TTL) metering; MULTI, SPOT, AVERAGE
<b>Exposure control</b>	Programmed AE (with program shift), shutter-priority AE, aperture-priority AE, and manual exposure
<b>Exposure compensation</b>	–2 EV– +2 EV in increments of ½ EV (except  ,  , <b>M</b> , and  )

<b>System</b>	
<b>Scene modes</b>	(NATURAL & LIGHT),  (NATURAL LIGHT),  (PORTRAIT),  (PORTRAIT ENHANCER),  (DOG),  (CAT),  (LANDSCAPE),  (SPORT),  (NIGHT),  (NIGHT (TRIPOD)),  (FIREWORKS),  (SUNSET),  (SNOW),  (BEACH),  (PARTY),  (FLOWER),  (TEXT)
<b>Picture stabilization</b>	Optical stabilization (image-sensor shift)
<b>Shutter speed (combined mechanical and electronic shutter)</b>	<ul style="list-style-type: none"> <li>• : 1/4 s–1/4,000 s</li> <li>• : 4 s–1/1,000 s</li> <li>• : 4 s–1/2 s</li> <li>• <b>P, S, A</b>: 4 s–1/4,000 s</li> <li>• <b>M</b>: 30 s–1/4,000 s</li> <li>• <b>Other modes</b>: 1/4 s–1/4,000 s</li> </ul>
<b>Continuous</b>	<ul style="list-style-type: none"> <li>• : max. 32 frames (RAW+JPEG/RAW: max. 6 frames); frame rate can be selected from 11, 8, 5, and 3 fps</li> <li>• : 16 or 8 frames; frame rate can be selected from 11, 8, 5, and 3 fps</li> <li>• : 3 frames (selected exposure, overexposure, underexposure)</li> <li>• : 3 frames (PROVIA, Velvia, ASTIA)</li> <li>• : 3 frames (100%, 200%, 400%)</li> </ul>
<b>Focus</b>	<ul style="list-style-type: none"> <li>• <b>Mode</b>: Single AF, continuous AF, manual focus with one-press AF</li> <li>• <b>Focus-area selection</b>: Center, multi, area, tracking</li> <li>• <b>Autofocus system</b>: Contrast-detect TTL AF with AF-assist illuminator</li> </ul>
<b>White balance</b>	Automatic scene detection; six manual preset modes for direct sunlight, shade, daylight fluorescent, warm white fluorescent, cool white fluorescent, and incandescent lighting; custom white balance
<b>Self-timer</b>	Off, 2 sec., 10 sec.; auto shutter release ( and )
<b>Flash</b>	Manual pop-up flash; effective range when sensitivity is set to <b>AUTO (800)</b> is approx. 30 cm–7.1 m/1 ft.–23.3 ft. (wide angle), 2.0 m–3.8 m/6.6 ft.–12.5 ft. (telephoto)
<b>Flash modes</b>	Auto, forced flash, off, slow synchro (red-eye removal off); auto with red-eye removal, forced flash with red-eye removal, off, slow sync with red-eye removal (red-eye removal on)
<b>Electronic viewfinder (EVF)</b>	0.2-in., 200k-dot color LCD viewfinder; frame coverage approx. 97%
<b>Monitor</b>	3.0-in., 460k-dot color LCD monitor; frame coverage approx. 100%
<b>Movies</b>	<ul style="list-style-type: none"> <li>• <b>HD 1920</b>: 1,920 × 1,080 (1080i), 30 fps</li> <li>• <b>HD 1280</b>: 1,280 × 720 (720p), 30 fps</li> <li>• <b>640</b>: 640 × 480 (VGA), 30 fps</li> <li>• <b>HS 640 × 480</b>: 640 × 480, 80 fps</li> <li>• <b>HS 320 × 240</b>: 320 × 240, 160 fps</li> <li>• <b>HS 320 × 112</b>: 320 × 112, 320 fps</li> </ul> <p><b>Note:</b> <b>HD</b>, <b>HD</b>, and <b>640</b> movies are recorded with stereo sound.</p>

<b>System</b>	
<b>Shooting options</b>	Dynamic range, Intelligent Face Detection with red-eye removal, framing guideline, frame number memory, film simulation, histogram display, Pro low-light, Pro focus, motion panorama 360, Electronic level
<b>Playback options</b>	Intelligent Face Detection, red-eye removal, micro thumbnail, multi-frame playback, image search, crop, resize, slide show, image rotation, voice memo, histogram display, exposure warning, favorites, photobook assist
<b>Other options</b>	PictBridge, Exif Print, language selection, time difference, silent mode, Eye-Fi Compatible
<b>Languages</b>	Arabic, Bulgarian, Simplified Chinese, Traditional Chinese, Czech, Danish, Dutch, English, Farsi, Finnish, French, German, Greek, Hebrew, Hungarian, Indonesian, Italian, Japanese, Kazakh, Korean, Latvian, Lithuanian, Norwegian, Polish, Portuguese, Romanian, Russian, Serbian, Slovak, Spanish, Swedish, Thai, Turkish, Ukrainian, Vietnamese
<b>Input/output terminals</b>	
<b>A/V OUT</b> (audio/video output)	NTSC or PAL output with monaural sound
<b>HDMI output</b>	HDMI Mini Connector
<b>Digital input/output</b>	USB 2.0 High Speed



**Power supply/other****Power sources**

- AA alkaline batteries (x4)
- AA lithium batteries (x4; available from third-party suppliers)
- AA rechargeable nickel-metal hydride (Ni-MH) batteries (x4; available from third-party suppliers)
- AC-5VX AC power adapter and CP-04 DC coupler (sold separately)

**Battery life (approximate number of frames that can be taken with fresh or fully charged batteries)**

Battery type	Approximate number of frames
Alkaline (type supplied with camera)	350
Lithium	700
Ni-MH	400

CIPA standard, measured in  (auto) mode using batteries supplied with camera (alkaline batteries only) and SD memory card.

**Note:** Number of shots that can be taken with battery varies with battery charge level and will decline at low temperatures.

**Camera dimensions**

130.6 mm x 90.7 mm x 126.0 mm/5.1 in. x 3.6 in. x 5.0 in. (W x H x D), excluding projections

**Camera weight**

Approx. 636 g/22.4 oz., excluding batteries, accessories, and memory cards

**Shooting weight**

Approx. 730 g/25.7 oz., including batteries and memory card

**Operating conditions**

• **Temperature:** 0°C – +40°C/+32°F – +104°F      • **Humidity:** 10% – 80% (no condensation)

### Color Television Systems

NTSC (National Television System Committee) is a color television telecasting specification adopted mainly in the U.S.A., Canada, and Japan. PAL (Phase Alternation by Line) is a color television system adopted mainly in European countries and China.

### Notices

- Specifications subject to change without notice; for the latest information, visit [http://www.fujifilm.com/products/digital\\_cameras/index.html](http://www.fujifilm.com/products/digital_cameras/index.html). FUJIFILM shall not be held liable for damages resulting from errors in this manual.
- Although the monitor is manufactured using advanced high-precision technology, small bright points and anomalous colors (particularly in the vicinity of text) may appear. This is normal for this type of monitor and does not indicate a malfunction; images recorded with the camera are unaffected.
- Digital cameras may malfunction when exposed to strong radio interference (e.g., electric fields, static electricity, or line noise).
- Due to the type of lens used, some distortion may occur at the periphery of images. This is normal.

# Memo

---

---

---

---

---

---

---

---

---

---

---

---

---

---

---

---

---

---

---

---

---

---

---

---

---

---

---

# FUJIFILM

---

**FUJIFILM Corporation**

7-3, AKASAKA 9-CHOME, MINATO-KU, TOKYO 107-0052, JAPAN

[http://www.fujifilm.com/products/digital\\_cameras/index.html](http://www.fujifilm.com/products/digital_cameras/index.html)

Download from [Www.Somanuals.com](http://www.Somanuals.com). All Manuals Search And Download.





Option	EXR				Adv.				SP1/SP2																																		
	EXR ENABLE						PAORAMA	P	S	A	M																																
	AUTO	✓																																									
	L		✓																																								
	M	✓	✓	✓	✓	✓	✓		✓	✓	✓	✓	✓	✓	✓	✓	✓	✓	✓	✓	✓	✓	✓	✓	✓	✓	✓	✓	✓	✓	✓	✓	✓	✓	✓	✓	✓	✓	✓	✓	✓	✓	
	S	✓	✓	✓	✓	✓	✓	✓ <sup>1</sup>	✓	✓	✓	✓	✓	✓	✓	✓	✓	✓	✓	✓	✓	✓	✓	✓	✓	✓	✓	✓	✓	✓	✓	✓	✓	✓	✓	✓	✓	✓	✓	✓	✓	✓	
	AUTO	✓ <sup>1</sup>				✓ <sup>1</sup>	✓ <sup>1</sup>	✓ <sup>1</sup>	✓ <sup>1</sup>	✓	✓	✓		✓ <sup>1</sup>	✓ <sup>1</sup>	✓ <sup>1</sup>	✓ <sup>1</sup>	✓ <sup>1</sup>	✓ <sup>1</sup>	✓ <sup>1</sup>	✓ <sup>1</sup>	✓ <sup>1</sup>	✓ <sup>1</sup>	✓ <sup>1</sup>	✓ <sup>1</sup>	✓ <sup>1</sup>	✓ <sup>1</sup>	✓ <sup>1</sup>	✓ <sup>1</sup>	✓ <sup>1</sup>	✓ <sup>1</sup>	✓ <sup>1</sup>	✓ <sup>1</sup>	✓ <sup>1</sup>	✓ <sup>1</sup>	✓ <sup>1</sup>	✓ <sup>1</sup>	✓ <sup>1</sup>	✓ <sup>1</sup>	✓ <sup>1</sup>			
	100		✓	✓	✓					✓	✓	✓	✓																														
	200				✓					✓	✓	✓	✓																														
	400				✓					✓	✓	✓	✓																														
	800				✓																																						
	1600				✓																																						
	DR	✓	✓	✓	✓	✓	✓	✓	✓	✓	✓	✓	✓	✓	✓	✓	✓	✓	✓	✓	✓	✓	✓	✓	✓	✓	✓	✓	✓	✓	✓	✓	✓	✓	✓	✓	✓	✓	✓	✓	✓ <sup>8</sup>		
	VDR		✓	✓	✓	✓	✓	✓	✓	✓	✓	✓	✓	✓																													
	SDR		✓	✓	✓	✓	✓	✓	✓	✓	✓	✓	✓	✓																													
	SDR		✓	✓	✓	✓	✓	✓	✓	✓	✓	✓	✓	✓	✓	✓	✓	✓	✓	✓	✓	✓	✓	✓	✓	✓	✓	✓	✓	✓	✓	✓	✓	✓	✓	✓	✓	✓	✓	✓	✓ <sup>8</sup>		
	VDR	✓	✓	✓	✓	✓	✓	✓	✓	✓	✓	✓	✓	✓	✓	✓	✓	✓	✓	✓	✓	✓	✓	✓	✓	✓	✓	✓	✓	✓	✓	✓	✓	✓	✓	✓	✓	✓	✓	✓	✓ <sup>8</sup>		
		✓	✓	✓				✓	✓	✓	✓																																
Color		✓	✓	✓				✓	✓	✓	✓																																
		✓	✓	✓				✓	✓	✓	✓																																
S		✓	✓	✓				✓	✓	✓	✓																																
		✓	✓	✓				✓	✓	✓	✓																																
	✓																																										
	✓ <sup>2</sup>	✓	✓	✓	✓	✓	✓	✓ <sup>3</sup>	✓	✓	✓	✓	✓	✓	✓	✓	✓ <sup>2</sup>	✓ <sup>2</sup>	✓ <sup>2</sup>	✓ <sup>3</sup>	✓ <sup>3</sup>	✓	✓	✓	✓	✓	✓	✓	✓	✓	✓	✓	✓	✓	✓	✓	✓	✓	✓	✓	✓ <sup>8</sup>		
	✓	✓	✓	✓	✓	✓	✓	✓	✓	✓	✓	✓	✓	✓	✓	✓			✓	✓		✓	✓	✓	✓	✓	✓	✓	✓	✓	✓	✓	✓	✓	✓	✓	✓	✓	✓	✓			
																																									✓		

Option	EXR			Adv.				SP1/SP2																																	
	EXR EYES				PAORAMA	P	S	A	M																																
	1920																																						✓		
	1280																																							✓	
	640																																							✓	
	HS 640 × 480																																							✓	
	HS 320 × 240																																								✓
	HS 320 × 112																																								✓
		✓	✓							✓	✓	✓	✓																												
		✓	✓							✓	✓	✓	✓																												
		✓	✓	✓						✓	✓	✓	✓																												
	P1	✓	✓	✓	✓	✓	✓	✓		✓	✓	✓	✓	✓	✓	✓	✓	✓	✓	✓	✓	✓	✓	✓	✓	✓	✓	✓	✓	✓	✓	✓	✓	✓	✓	✓	✓	✓ <sup>8</sup>			
	P2	✓	✓	✓	✓	✓	✓	✓		✓	✓	✓	✓	✓	✓	✓	✓	✓	✓	✓	✓	✓	✓	✓	✓	✓	✓	✓	✓	✓	✓	✓	✓	✓	✓	✓	✓	✓	✓ <sup>8</sup>		
	OFF	✓	✓	✓	✓	✓	✓	✓	✓ <sup>1</sup>	✓	✓	✓	✓	✓	✓	✓	✓	✓	✓	✓	✓	✓	✓	✓	✓	✓	✓	✓	✓	✓	✓	✓	✓	✓	✓	✓	✓	✓	✓ <sup>8</sup>		
AF	✓	✓	✓	✓	✓	✓	✓	✓		✓	✓	✓	✓	✓	✓	✓	✓	✓	✓	✓	✓	✓	✓	✓	✓	✓	✓	✓	✓	✓	✓	✓	✓	✓	✓	✓	✓	✓	✓ <sup>8</sup>		
RAW	✓	✓	✓	✓						✓	✓	✓	✓	✓	✓	✓	✓	✓	✓	✓	✓	✓	✓	✓	✓	✓	✓	✓	✓	✓	✓	✓	✓	✓	✓	✓	✓	✓	✓	✓	

1 Optimized for selected shooting mode.

2 **ON** selected automatically.

3 **OFF** selected automatically.

4 Flash disabled in all shooting modes if lowered.

5 (MULTI) selected automatically when Intelligent Face Detection is on.

6 Camera focuses on faces when Intelligent Face Detection is on.

7 Intelligent Face Detection turns off automatically in manual focus mode.

8 Fixed at settings before recording a movie.



## Free Manuals Download Website

<http://myh66.com>

<http://usermanuals.us>

<http://www.somanuals.com>

<http://www.4manuals.cc>

<http://www.manual-lib.com>

<http://www.404manual.com>

<http://www.luxmanual.com>

<http://aubethermostatmanual.com>

Golf course search by state

<http://golfingnear.com>

Email search by domain

<http://emailbydomain.com>

Auto manuals search

<http://auto.somanuals.com>

TV manuals search

<http://tv.somanuals.com>