



www.gracobaby.com

Contender™ 65 Child Restraint

Owner's Manual

READ THIS MANUAL.

Do not install or use this child restraint until you read and understand the instructions in this manual.

FAILURE TO PROPERLY USE THIS CHILD RESTRAINT INCREASES THE RISK OF SERIOUS INJURY OR DEATH IN A SUDDEN STOP OR CRASH.

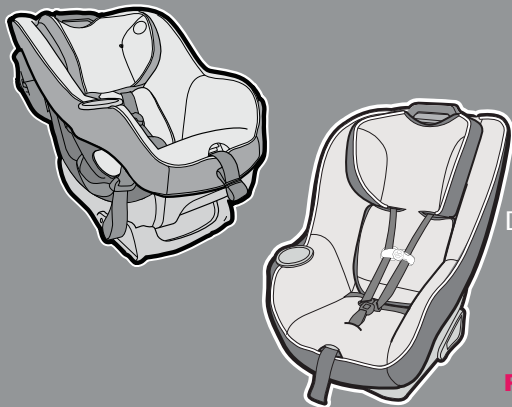

TABLE OF CONTENTS

Before You Begin

Important Information.....	4-6
Warnings.....	7-10
Basic Information.....	11
What is LATCH ?.....	12-13
LATCH System.....	14

Use

Height & Weight Limits.....	15-17
Features.....	18-19
Rear-Facing Installation With LATCH	20-21
Forward-Facing Installation With LATCH	22-23
Rear-Facing Installation With Vehicle Seat Belts.....	24-25
Forward-Facing Installation With Vehicle Seat Belts.....	26-27

Placing Child in Child Restraint.....	28-31
Operations and Adjustments.....	32-43
• Harness Straps.....	32
• Chest Clip.....	33
• Buckle.....	33
• Crotch Strap Adjustment.....	34-35
• Recline Flip Foot.....	36
• Level Indicator.....	37
• Removing LATCH From Vehicle Anchor Points.....	38
• Removing Tether From Vehicle.....	38
• LATCH Storage.....	39
• LATCH Belt Routing for Rear-Facing Mode.....	40-41
• LATCH Belt Routing for Forward-Facing Mode.....	42-43

TABLE OF CONTENTS

Special Information

Vehicle Seat Belts.....	44-51
• Locking Clip.....	49-50
Additional Information.....	52-59
• Tether Storage.....	52
• Body Support (on certain models).....	53
• Head Pillow (on certain models).....	54
• Harness Covers (on certain models).....	54
• Care and Cleaning.....	55-57
• Buckle Cleaning Process.....	58
• Aircraft Use.....	59
• Second Hand Child Restraint.....	59
Replacement Parts.....	60
• Locking Clip Storage.....	60
• Instruction Manual Storage.....	60

IMPORTANT INFORMATION

No child restraint can guarantee protection from injury in every situation, but proper use helps reduce the risk of serious injury or death.

READ THIS MANUAL CAREFULLY.

Safety First Check List

- ✓ Read and understand instruction manual and child restraint labels.
- ✓ Infants less than 20 lbs. (9.1kg) **must** use child restraint **rear-facing**.
Infants or toddlers 20 to 40 lbs. (9.1kg to 18.1kg) may be **rear-facing**.
- ✓ Do not use child restraint **rear-facing** in vehicle seat with air bag.
- ✓ Secure children in rear seat of vehicle whenever possible.
- ✓ Never leave child unattended.
- ✓ Install child restraint securely with vehicle seat belt or **LATCH** belt.
- ✓ Do not use after the useful life date shown on back of child restraint.
- ✓ Do not allow anyone (babysitter, relatives, etc.) to use child restraint without first understanding all instructions.

IMPORTANT INFORMATION (continued)

Registration Information

Model Number: _____

Date of Manufacture: _____

Purchase Date: _____

Register Your Child Restraint

Please fill in the above information. The model number and date of manufacture can be found on a label on the child restraint. Fill out the prepaid registration postcard attached to the harness and mail it today.

Child restraints could be recalled for safety reasons. You must register this restraint to be reached in a recall. Send your name, address, and the restraint's model number and date of manufacture to:

Graco Children's Products, Inc.

Attn: Customer Service, 3 Glenlake Parkway Atlanta, GA 30328

or call 1-800-345-4109 or register online at

<http://www.gracobaby.com/carseatregistration>

IMPORTANT INFORMATION (continued)

For recall information:

Call the U.S Government's Vehicle Safety Hotline at 1-888-327-4236 (TTY: 1-800-424-9153), or go to <http://www.NHTSA.gov>

If You Need Help:

In the U.S.A, please contact our Customer Service Department with any questions you may have concerning parts, use, or maintenance. When you contact us, please have your product's **model number and date of manufacture** ready so that we may help you efficiently. These numbers can be found on a sticker on the back side of your child restraint.

**1-800-345-4109 or www.gracobaby.com
www.cpsc.gov
www.NHTSA.gov
www.seatcheck.org**

! **WARNINGS** - *Prevent serious injury or death:*

NEVER PLACE THIS CHILD RESTRAINT IN A VEHICLE SEATING LOCATION THAT HAS A FRONT AIR BAG. If an air bag inflates, it can hit the child and child restraint with great force and cause serious injury or death to your child. Refer to your vehicle owner's manual for information about side air bags and child restraint installation.



WARNINGS - *Prevent serious injury or death:* (continued)

Failure to follow these instructions and child restraint labels can result in child striking the vehicle's interior during a sudden stop or crash. Secure child restraint with a vehicle seat belt or **LATCH** that is properly routed as shown in this manual.

Select a suitable location for the child restraint in your vehicle.

Choose the correct mode of use for the child restraint depending on your child's size. Infants less than 20 lbs. (9.1kg) must use this child restraint **rear-facing**.

Serious crippling injury or death can result if infant faces front of vehicle.

The American Academy of Pediatrics (AAP) recommends that children be **rear-facing** until age 2 or until they reach the maximum **rear-facing** height and weight rating for their seat.

Vehicle seat belt system **MUST** hold child restraint securely. Not all vehicle seat belts can be used with a child restraint.

If vehicle seat belt does not hold child restraint securely, read "Vehicle Seat Belts" section.

WARNINGS - *Prevent serious injury or death:* (continued)

Never put a child restraint in a front vehicle seat unless recommended by vehicle owner's manual. National Highway Traffic Safety Administration (NHTSA) alerts vehicle owners that according to accident statistics, children are safer in the rear seat. For vehicles with air bags, refer to vehicle owner's manual for child restraint installation information.

If child restraint is in a crash, it must be replaced. **DO NOT** use it again! A crash can cause unseen damage and using it again could result in serious injury or death. **DO NOT** use child restraint if it is damaged or missing parts.

DO NOT use accessories or parts other than those provided by Graco. Their use could alter the performance of the child restraint. **Rear-facing** child restraint must be properly leveled:

- Too reclined can result in injury or ejection.
- Too upright can result in breathing difficulties.

! WARNINGS - *Prevent serious injury or death:* (continued)

Never leave child unattended, even when sleeping. Child may become tangled in harness straps and suffocate or strangle.

DO NOT remove **LATCH** system from child restraint. If using vehicle seat belt to secure child restraint, **LATCH** connectors must be stored. (see section "**LATCH** storage")

Never attach two **LATCH** connectors to one vehicle lower anchor point unless specifically allowed by the vehicle manufacturer.

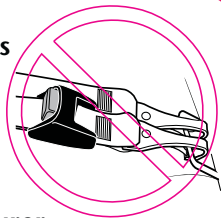

BASIC INFORMATION

Certification

This child restraint meets or exceeds all applicable requirements of Federal Motor Vehicle Safety Standard 213 for use in motor vehicles and aircraft.

Unoccupied Child Restraint

Always secure child restraint to **LATCH** or a vehicle seat belt, even when unoccupied. In a crash, an unsecured child restraint can injure passengers.

Dangerous Vehicle Seats

Do not use child restraint on rear-facing or side-facing vehicle seats.



Child Restraint Useful Life

STOP using this child restraint and throw it away 7 years after the date of manufacture. Look for this sticker on rear of child restraint:

MODEL

NAME

Date of Manufacture

year

month

day

GRACO CHILDREN'S PRODUCTS, INC.
ATLANTA, GA 30328 1-800-345-4109
Made in China

Vehicle Seat Protection

Protect vehicle seat. Use a child restraint mat, towel, or thin blanket under and behind child restraint.

Warm Weather

Child restraint parts can get very hot in the sun or warm weather. **To avoid burns, always check before putting child in child restraint.**

WHAT IS LATCH?

United States Federal Motor Vehicle Safety Standards have defined a system for installing child restraints in vehicles. The system is called **LATCH**. **LATCH** stands for:

Lower **A**nchors and **T**ethers for **C**hildren.



LATCH System for Vehicles:

LATCH in the vehicle consists of a top tether anchor point and two lower anchor points.

Some vehicle owner manuals use the term **ISOFIX** to identify the new child restraint anchor system. This child restraint with **LATCH** can also be used in vehicle seating positions equipped with **ISOFIX**.

Newer vehicles may have one or more seating positions equipped with **LATCH** anchor points.

If vehicle is equipped with **LATCH**, the vehicle lower anchor points may be visible at the vehicle seat crease. If not visible, they may be marked with a symbol  or a colored dot.

Check vehicle owner's manual for vehicle top tether anchor locations. They may be identified using one of the anchor symbols   .

Use vehicle belt (not **LATCH** connectors) for installations with children weighing more than 42 lbs (19.1 kg).

NOTE: Some vehicle manufacturers have lower maximum weight ratings for **LATCH** anchors, so you must consult your vehicle owner's manual or call the vehicle manufacturer to confirm the limits on your vehicle's **LATCH** anchors.

WHAT IS LATCH? (continued)

Vehicle Top Tether Anchor Points

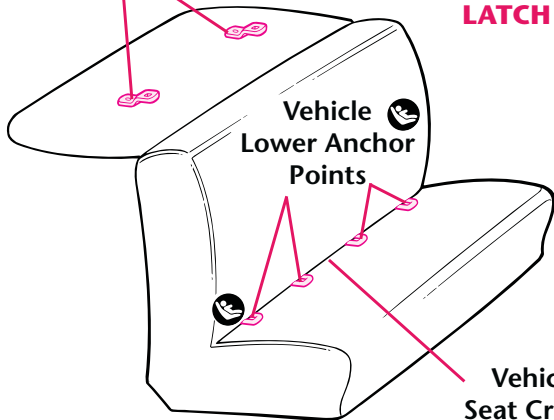

Typical seat in a passenger vehicle. Other vehicle types may have different **LATCH** locations.

See your vehicle owner's manual for exact locations, anchor identification, and requirements for use with a child restraint.

LATCH SYSTEM

LATCH consists of a permanently attached lower anchor belt and a top tether strap.

ONLY use **LATCH** in a seating position recommended by vehicle manufacturer.

LATCH BELT IN FORWARD-FACING MODE

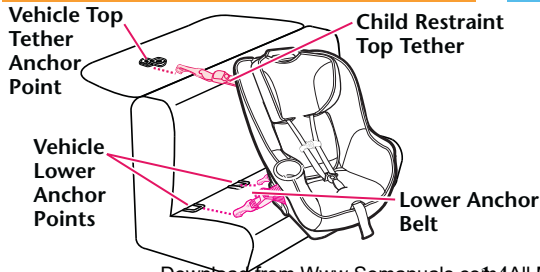

LATCH BELT IN REAR-FACING MODE

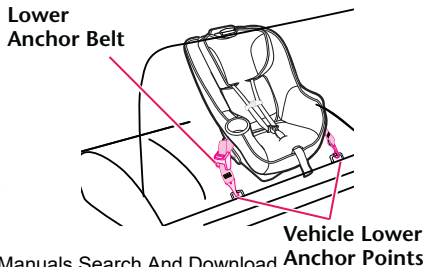

HEIGHT & WEIGHT LIMITS

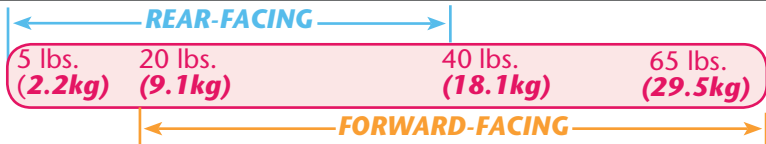

Rear-facing: 5 to 40 lbs. (2.2kg-18.1kg)

- Infants who weigh less than 20 lbs. (9.1kg) **MUST** be **rear-facing**.
- Infants or toddlers 20 to 40 lbs. (9.1kg to 18.1kg) may be **rear-facing**.
- Harness height must be **at** or **just below** child's shoulders.
- Child's head must be at least 1" below the red handle.

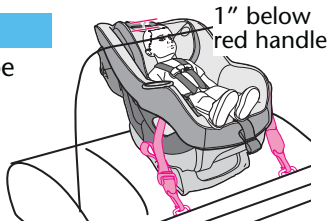

IMPORTANT: This child restraint is certified for use **rear-facing** with children up to 40 lbs. (18.1kg). However, some children approaching 40 lbs. (18.1kg) may be too tall to fit **rear-facing**. Child should use child restraint **forward-facing** only if child is over 20 lbs. (9.1kg) and can sit upright unassisted.

(★, see American Academy of Pediatrics (AAP) recommendations on p. 8 and p. 17).

HEIGHT & WEIGHT LIMITS (continued)

Forward-facing: 20 to 65 lbs. (9.1kg to 29.5kg)

- Child must not exceed 52 inches (132 cm).
- Toddlers 20 to 65 lbs. (9.1kg to 29.5kg) who are capable of sitting upright unassisted may be **forward-facing**. If unable to sit unassisted, use **rear-facing**.
- Toddlers 40 to 65 lbs. (18.1kg to 29.5kg) and up to 52 inches (132 cm) tall **MUST** be **forward-facing**.
- Harness height must be **at** or **just above** child's shoulders.
- Child's head must be at least 1" below the red handle.

See p. 8 for American Academy of Pediatrics (AAP) recommendations.



Preterm or Low Birthweight Infants *

A preterm infant or low birth weight infant (preemies) may be at special risk in a vehicle or aircraft.

According to the American Academy of Pediatrics (AAP), these infants may suffer breathing difficulties if improperly reclined in a child restraint.

When installing the child restraint *rear-facing*, use corrected age for preemies (see pg. 37 for more information).

Graco advises that you have your physician or hospital staff evaluate your infant and recommend the proper child restraint or car bed before you and your infant leave the hospital.

FEATURES

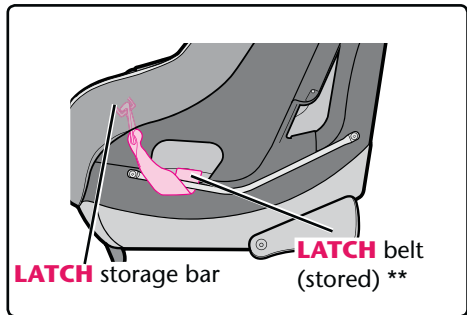
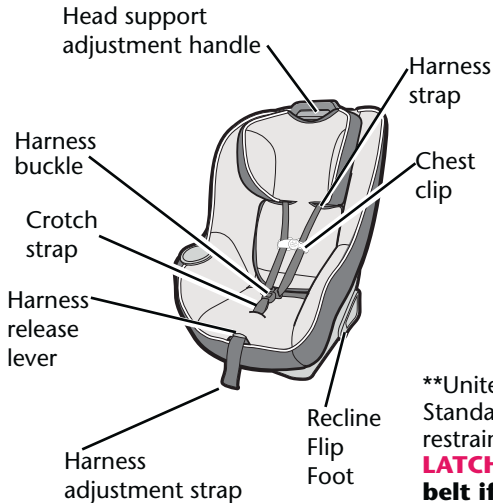

United States Federal Motor Vehicle Safety Standards have defined a system for installing child restraints in vehicles. The system is called **LATCH. **LATCH may ONLY be used IN PLACE of vehicle belt if vehicle is equipped with LATCH anchor points. Please refer to vehicle owner's manual for LATCH locations in vehicles.**

FEATURES

***Vehicles are now (or can be) equipped with tether anchor points behind some seats. A tether anchors the top of the child restraint to the body of the vehicle. When used properly with the vehicle seat belt or **LATCH**, a tether helps reduce injury in a sudden stop or crash.

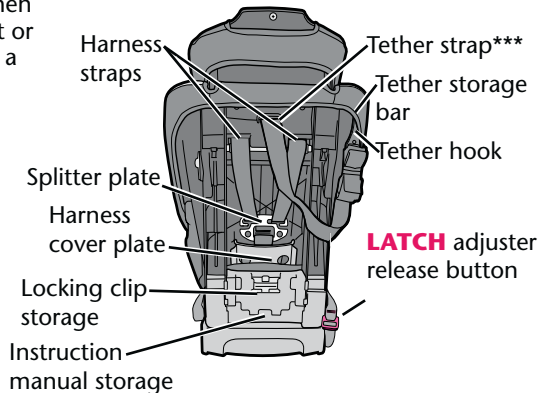

REAR-FACING INSTALLATION WITH LATCH

1. Recline flip foot must be in REAR-FACING position **(a)**. (If it is not, see page 36, Recline Flip Foot.)
2. **LATCH** belt must be routed through the opening in child restraint marked as REAR-FACING with a BLUE label **(b)**. (If it is not, see page 40, **LATCH** Belt Routing For Rear-Facing Mode.)
3. Place **rear-facing** on vehicle seat equipped with **LATCH** anchors. For ease of installation, extend **LATCH** belt to its maximum length.
4. Attach **LATCH** connectors to vehicle lower anchors **(c)**. Belt must lie flat and not be twisted. Pull connectors to be sure they are securely attached to the anchor points. **(d)**.
5. Press down firmly in center of child restraint while pulling on the tail of the **LATCH** belt to tighten **(e)**.

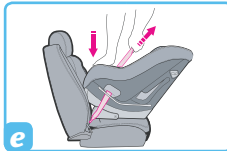
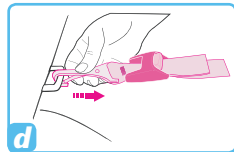
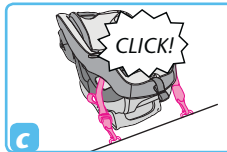
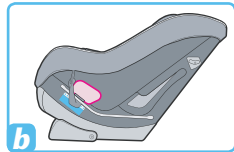
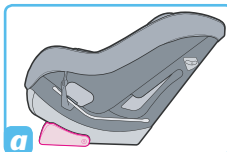

6. Hold seat and pull front to back and left to right at belt path to check for secure installation **(f)**. The child restraint should not move side to side or forward more than 1 inch (2.5cm). Check that the lower anchor belt stays tight and does not slip from the tightened position. If it does not stay tight, try another seating position or contact Customer Service.

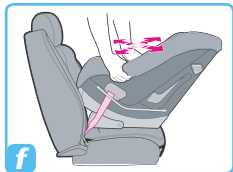

7. Check level indicator on child restraint **(g)**.

Vehicle **must** be on level ground and child in child restraint when checking level indicator. Ball **MUST** be entirely in blue zone **(g)**. If necessary, place rolled towels under child restraint, at vehicle seat crease, until entire ball is in blue zone. Then re-check level indicator (see page 37).

- **DO NOT** use tether **rear-facing**. Tether **must** be stored (see “Tether Storage” page 52).
- Periodically check that child restraint is securely installed and properly leveled; adjust if necessary.
- To remove **LATCH**, see “Removing **LATCH** from Vehicle Anchor Points”, p. 38.

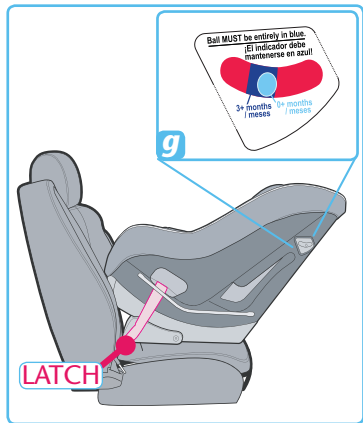

FORWARD-FACING INSTALLATION WITH LATCH

1. Recline flip foot must be in FORWARD-FACING position **(a)**. (If it is not, see page 36, Recline Flip Foot.)
2. **LATCH** belt must be routed through the opening in child restraint marked as FORWARD-FACING with an ORANGE label **(b)**. (If it is not, see page 42, **LATCH** Belt Routing For Forward-Facing Mode.)
3. Unhook tether from tether storage (see page 52).
4. Place **forward-facing** on vehicle seat equipped with **LATCH** anchors. For ease of installation, extend **LATCH** belt to its maximum length.
5. Attach **LATCH** connectors to vehicle lower anchors **(c)**. Belt must lie flat and not be twisted. Pull connectors to be sure they are securely attached **(d)**.

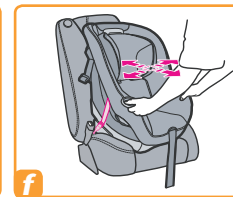
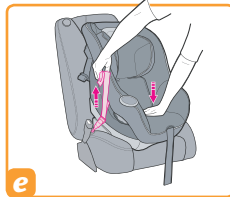
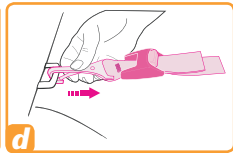
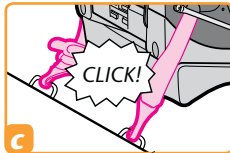
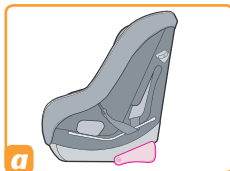

6. Press down firmly in center of child restraint to compress vehicle seat cushion while pulling on the tail of the **LATCH** belt to tighten **(e)**.
7. Hold seat and pull front to back and left to right at belt path to check for secure installation **(f)**. The child restraint should not move side to side or forward more than 1 inch (2.5 cm).
8. Check that the lower anchor belt stays tight and does not slip from the tightened position. If it does not stay tight, try another seating position or contact Customer Service.
9. Attach tether strap hook **(A)** to anchor hardware **(B)** and tighten adjustment belt to remove any slack **(g)**. Belt must lie flat and not be twisted. Periodically check that child restraint is securely installed; adjust if necessary.

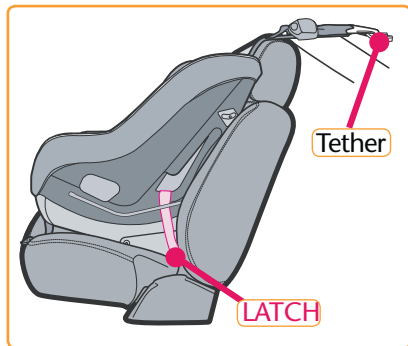
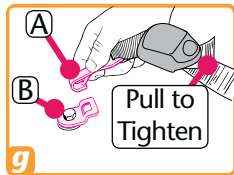

- To remove **LATCH**, see “Removing **LATCH** from Vehicle Anchor Points”, p. 38.

REAR-FACING INSTALLATION WITH VEHICLE SEAT BELTS

⚠ WARNING

LATCH belt **MUST** be stored when using vehicle seat belt to install child restraint.

Please refer to p.44, "Vehicle Seat Belts" to determine what type of vehicle seat belt is in your vehicle.

1. Store **LATCH** belt as shown **(a)**. Recline flip foot must be in **REAR-FACING** position **(b)**.
2. Place **rear-facing** on vehicle seat.
3. Thread vehicle seat belt through **rear-facing** openings **under** the seat pad and buckle belt **(c)**. Be sure to route the vehicle seat belt in between the harness buckle slots **(d)**. Press down firmly in center of child restraint to compress vehicle seat cushion while tightening vehicle seat belt **(e)**.

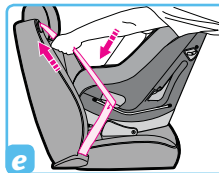
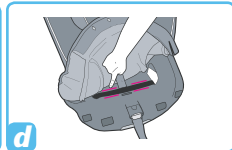
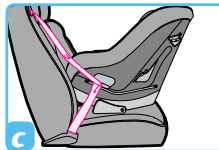
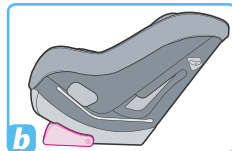
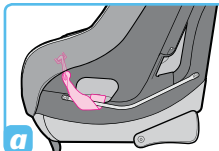

4. Hold seat and pull front to back and left to right at the belt path to check for secure installation. **(f)**. The child restraint should not move side to side or forward more than 1 inch (2.5 cm). Vehicle lap belt **MUST** stay tight. If not secure, see "Vehicle Seat Belts" page 44.

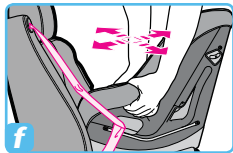

5. Check level indicator on child restraint. **Vehicle must be on level ground** and child in child restraint when checking level indicator.

6. Ball **MUST** be entirely in blue zone **(g)**. If necessary, place rolled towels under child restraint, at vehicle seat crease **(h)**, until entire ball is in blue zone. Then re-check level indicator (see page 37).

DO NOT use tether **rear-facing**. Tether **must** be stored (see "Tether Storage" page 52). Periodically check that child restraint is securely installed and properly leveled; adjust if necessary.

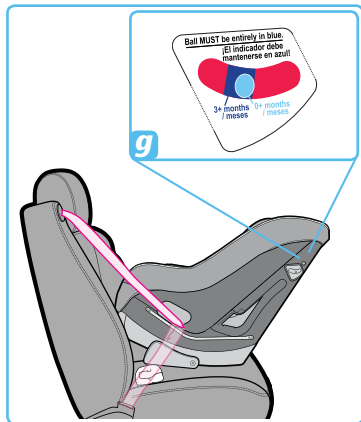
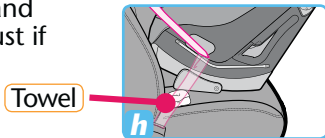

FORWARD-FACING INSTALLATION WITH VEHICLE SEAT BELTS

WARNING

LATCH belt **MUST** be stored when using vehicle seat belt to install child restraint.

Please refer to p.44, "Vehicle Seat Belts" to determine what type of vehicle seat belt is in your vehicle.

1. Store **LATCH** belt as shown **(a)**. Recline flip foot must be in FORWARD-FACING position **(b)**.
2. Unhook tether from tether storage, see page 52.
3. Place **forward-facing** on vehicle seat.
4. Thread vehicle seat belt through **forward-facing** openings and buckle belt **(c)**.

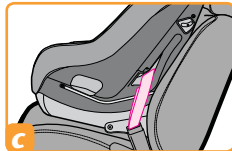
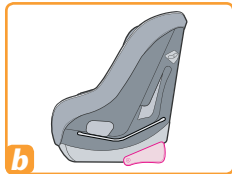
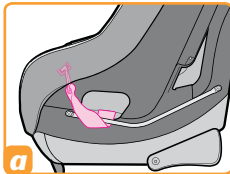

5. Press down firmly in center of child restraint to compress vehicle seat cushion while tightening vehicle seat belt (**d**).
6. Hold seat and pull front to back and left to right at belt path to check for secure installation (**e**). The child restraint should not move side to side or forward more than 1 inch (2.5 cm). Vehicle lap belt **MUST** stay tight. If not secure, see "Vehicle Seat Belts" pg. 44.
7. Attach tether strap hook (**A**) to anchor hardware (**B**) and tighten adjustment belt to remove any slack (**f**). If vehicle does not have anchor points to attach tether hook, tether hook should be stored, see "Tether Storage", page 52. Belt must lay flat and not be twisted. Periodically check that child restraint is securely installed; adjust if necessary.

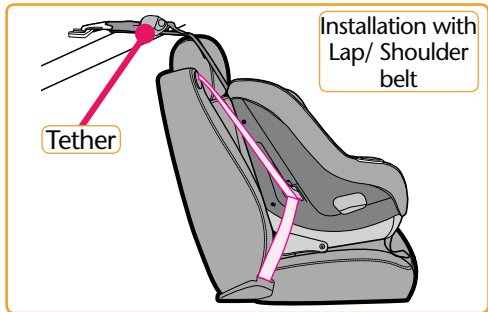
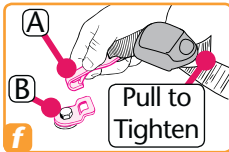
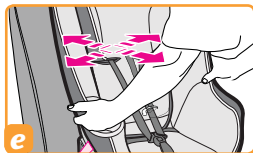
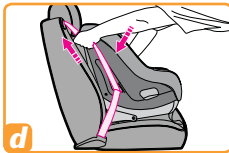

PLACING CHILD IN CHILD RESTRAINT

Check Harness System

⚠ WARNING

To prevent serious injury or death:

- Keep harness straps snug and positioned on shoulders with chest clip at arm pit level.
- Do not use strap covers, blankets, cushions, or padding under harness straps or child unless provided by Graco.
- Child should be dressed in clothing that does not interfere with buckling the harness.
- Failure to properly adjust the harness straps for your child increases the risk of serious injury or death in the event of a sharp turn, sudden stop or crash.

REAR-FACING

- 5-40 lbs (2.2kg-18.1kg)
- Harness height must be at or just below child's shoulders. Body support *** MUST** be used if shoulders are below lowest harness setting (***** see page 53).
- Child's head must be at least 1" below the red handle.

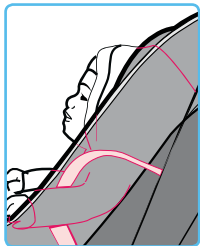

FORWARD-FACING

- 20-65 lbs (9.1kg-29.5kg)
- Harness height must be at or just above child's shoulders.
- Child's head must be at least 1" below the red handle.

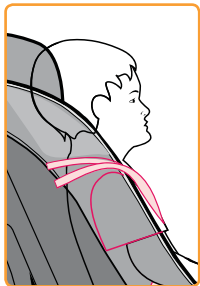

Adjusting Head Support

- **BEFORE** adjusting the head support height, have your child lean forward slightly.
- Squeeze and pull up the red head support adjustment handle (a) on top of seat until it locks into one of the 8 height positions. There will be an audible click and the red head support adjustment handle will return to its original position (b).
- To lower, squeeze red head support adjustment handle and push head support down.
- When head support is in lowest position, always pull flap forward as shown. (c).

Rear-facing

- Head support should be positioned so the harness straps are at or just below the shoulders and child's head must be at least 1" below the red handle.
- Make sure the head support does not touch the front vehicle seat.

Forward-facing

- Head support should be positioned so that the harness straps are at or just above the child's shoulders, 20-65 lbs (9.1kg-29.5kg).

Refer to page 28 for harness strap placement.

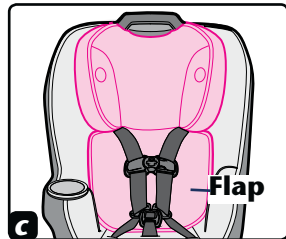
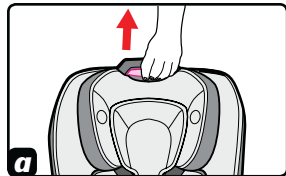

PLACING CHILD IN CHILD RESTRAINT (continued)

1. Place child in child restraint with child's back flat against back of child restraint.
2. Place harness straps over child's shoulders and insert tongue(s) into buckle (see page 33).

Pull up on tongue(s) to be sure they are locked.

3. Close chest clip. Position chest clip at armpit level (see page 33).

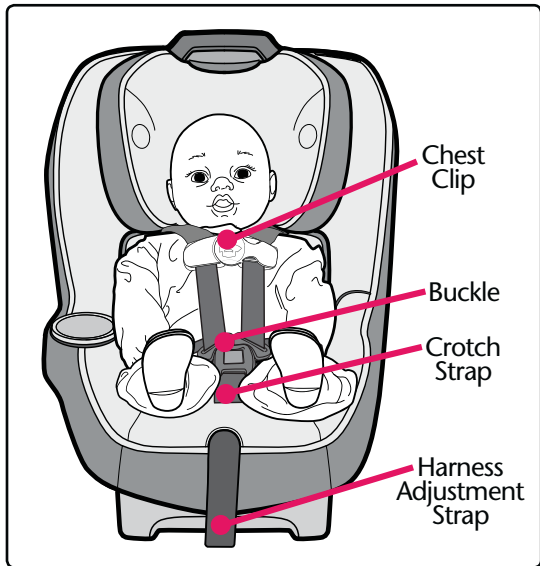

4. Adjust harness straps to be snug. **CHECK** that the harness is snug. You should **not** be able to pinch the harness if it is snug. A snug strap should not allow any slack. It lies in a relatively straight line without sagging. It does not press on the child's flesh or push the child's body into an unnatural position **(a)**

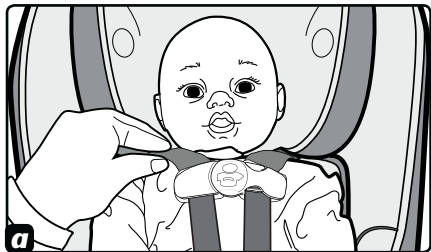

Check that harness straps on **chest** and **thighs** are snug.

5. A rolled towel can be used on each side to support small children **(b)**. Be sure towels do not interfere with harness system. Towels should **NOT** be placed under child.



OPERATIONS & ADJUSTMENTS

Harness Straps:

- To tighten: Pull harness adjustment strap **(a)**
- To loosen: Lift lever **(b)** while pulling shoulder harness straps **(c)**.

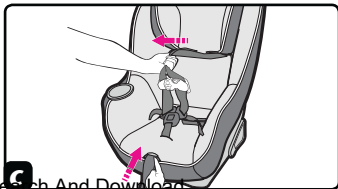
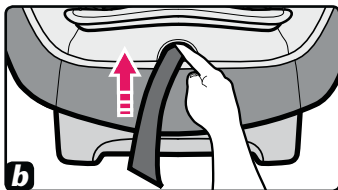
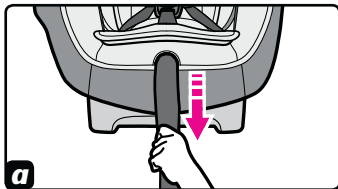
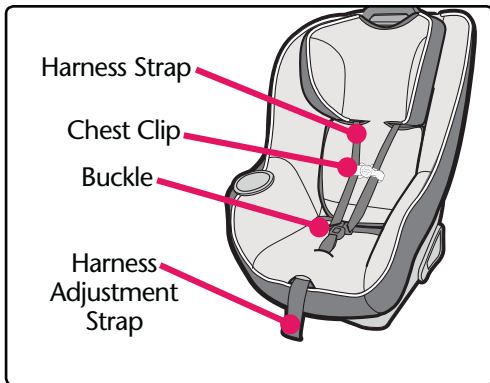

Chest Clip:

- To open: Press tabs and pull apart **(d)**
- To close: Snap halves together. Make sure the chest clip is locked by pulling out on each half. **(e)**

Buckle:

- To buckle: Insert both tongues into buckle. Pull up on tongues to be sure they are locked **(f)**.
To tighten: Pull harness adjustment strap **(g)**
- To unbuckle: Loosen by lifting lever and pulling shoulder harness straps **(h)**. Press in the red button **(i)** and pull tongues out of buckle. **(j)**

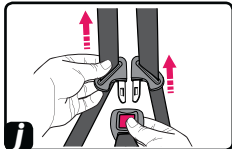
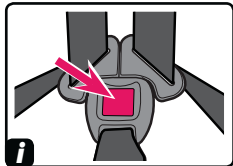
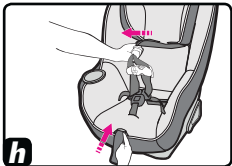
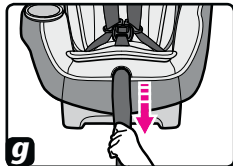
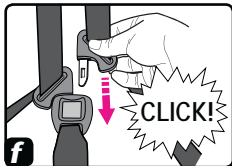
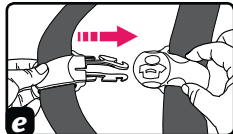
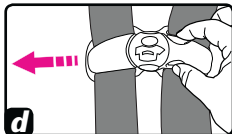

Crotch Strap Adjustment:

Check the crotch strap: Choose the position that is closest to but not under your child.

- Recline flip foot must be in **forward-facing** position **(k)**.
- From bottom of child restraint, rotate metal retainer to side in order to push it through slot easier **(l)**.
- Pull crotch strap from child restraint as shown **(m)**.
- When changing crotch buckle location **LATCH** belt must pass between the **LATCH** belt lines as shown **(n)**.
- Insert crotch strap into desired slot **(o)**. Pull up on crotch strap to be sure it is secure.

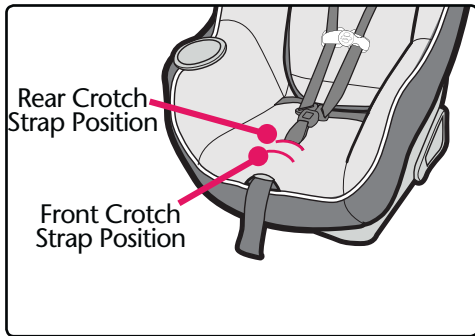
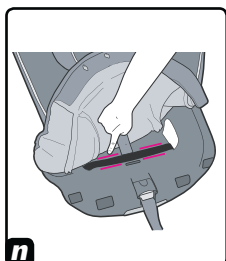
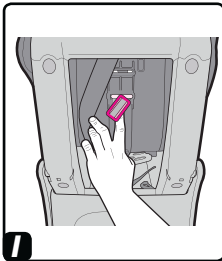
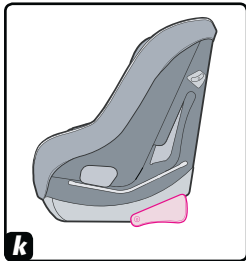

OPERATIONS & ADJUSTMENTS (continued)

Recline Flip Foot

For Rear-Facing: Rotate flip foot **(a)** to **rear-facing** position **(b)**.

- Ball in level indicator must be entirely in blue **(c)**. See page 37 for proper level indicator use. If necessary, use a pool noodle or tightly rolled towel for leveling **(d)**.
- Vehicle must be on level ground and child in child restraint when checking level indicator.

NOTE: Level indicator is for rear-facing use only.

For Forward-Facing: Rotate flip foot **(e)** to **forward-facing** position **(f)**.

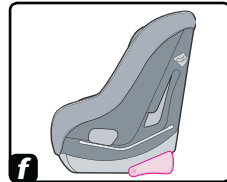
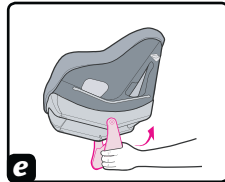
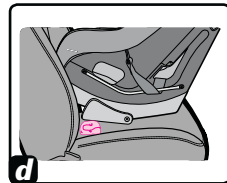
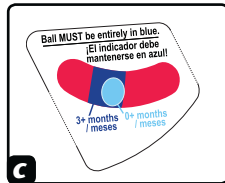
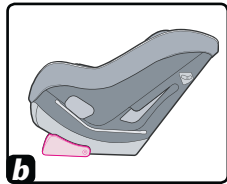
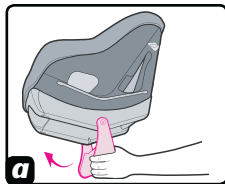

OPERATIONS & ADJUSTMENTS (continued)

Level Indicator

Use corrected age for preemies.

WARNING

FAILURE TO PROPERLY recline the infant restraint on the vehicle seat increases the risk of serious injury or death.

- If the ball is entirely in light blue, the restraint is level for infants 0+ months in age.



- If the ball is in light blue and dark blue, the restraint is level for a child 3+ months in age.



- If the ball is in **RED**, child restraint is **NOT** level. You must adjust your recline position.



OPERATIONS & ADJUSTMENTS (continued)

Removing **LATCH** from Vehicle Anchor Points:

1. To remove **LATCH**, push button while pulling on the **LATCH** belt as shown **(a)**.
2. Press and hold **LATCH** release hinge **(b)**.
3. Push connector in, lift connector up and pull out (away from anchor point) **(c)**.
4. Repeat step **1**, **2** and **3** for other connector.

Removing Tether from Vehicle

1. Release the tension on the tether connector by lifting lever as shown **(d)**.
2. Press and hold tether release hinge. **(e)**
3. Push connector in, lift connector up and pull out (away from anchor point)**(e)**.

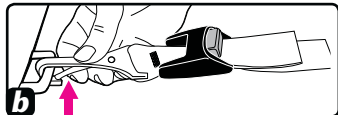
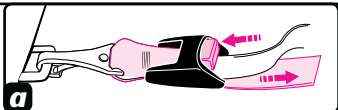



LATCH Storage:

1. Fasten **LATCH** onto storage bar as shown **(a)**.

Repeat for other side of seat.

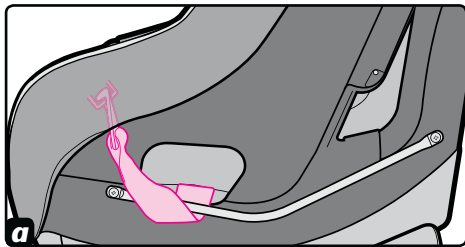

OPERATIONS & ADJUSTMENTS (continued)

LATCH Belt Routing For Rear-Facing Mode

1. Pull the **LATCH** belt out of the **forward-facing** belt path opening, so that the **LATCH** hooks end up on the same side of the child restraint **(a)**.
2. Slide the **LATCH** belt along the bar to the **REAR-FACING** belt path opening, marked with a **BLUE** label **(b)**.
3. Unclip the seat pad from the front of the child restraint **(c)**.

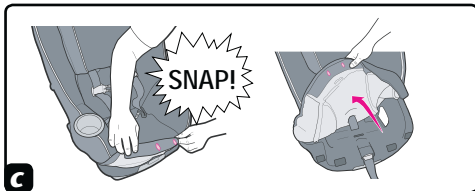
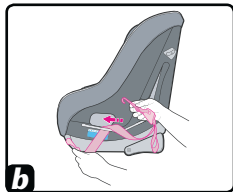
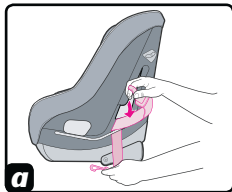

OPERATIONS & ADJUSTMENTS

LATCH Belt Routing For Rear-Facing Mode

4. Feed the **LATCH** hook with the gray button on it back through the **REAR-FACING** belt path opening (**d**). Be sure to route the **LATCH** belt in between the buckle slots (**e**). Ensure the belt is flat and not twisted.
5. Replace the seat pad fabric on the front of the child restraint (**f**).

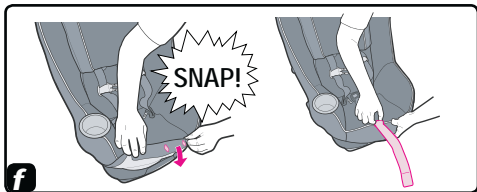
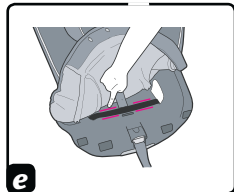
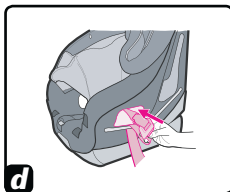

OPERATIONS & ADJUSTMENTS (continued)

LATCH Belt Routing For Forward-Facing Mode

1. Unclip the seat pad from the front of the child restraint to expose the **LATCH** belt (**a**).
2. Pull the **LATCH** belt out of the **rear-facing** belt path opening, so that the **LATCH** hooks end up on the same side of the child restraint (**b**).

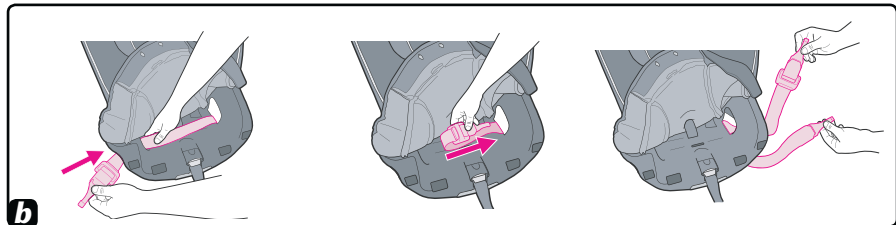
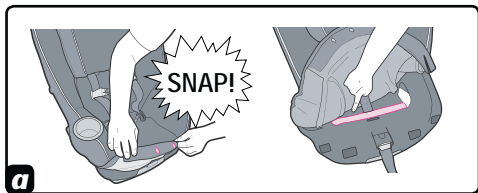

OPERATIONS & ADJUSTMENTS

LATCH Belt Routing For Forward-Facing Mode

- Slide the **LATCH** belt along the bar to the FORWARD-FACING belt path opening, marked with an ORANGE label (**c**).
- Feed the **LATCH** hook with the gray button on it back through the FORWARD-FACING belt path opening (**d**). Ensure the belt is flat and not twisted (**e**).
- Replace the seat pad fabric on the front of the child restraint (**f**).

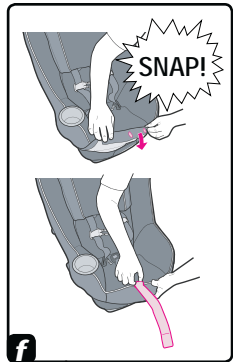
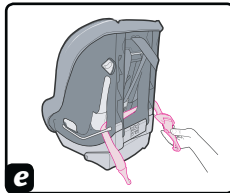
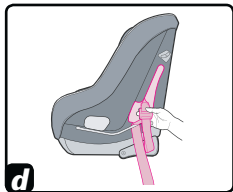
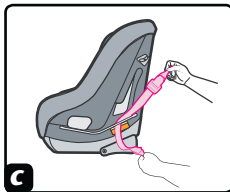

VEHICLE SEAT BELTS

WARNING

Not all vehicle seat belts can be used with a child restraint. The child restraint must be held securely at all times by a lap belt (or lap belt portion of a lap/shoulder belt) that will not change length while driving.

To provide the most secure installation of the child restraint:

- Read the vehicle owner's manual regarding child restraint installation and seat belt use with child restraint.
- Follow all instruction labels on vehicle seat belt and child restraint.

If child restraint is not held securely after following instructions in this manual, vehicle seat belt labels, and vehicle owner's manual:

- Move child restraint to another seating location and try again, or
- Or you can visit the **www.seatcheck.org** website to find a child car seat inspection station nearest you.

VEHICLE SEAT BELTS (continued)

Lap/Shoulder Belt with Switchable Retractor and Sliding Latch Plate

Follow these steps to determine if you have a retractor system that will hold child restraint securely:

- Pull belt all the way out
- Allow belt to retract about 6 inches (15cm)
- If you hear clicking, slowly pull out on belt again, if it locks, then you have a retractor that can be switched to an Automatic Locking Retractor Mode and can be used to secure your seat to vehicle.

If you don't have a retractor that can be switched to an Automatic Locking Retractor Mode AND you pull on the latch plate and it slides freely, a locking clip **MUST** be used (see Pg. 49 "Locking Clip" section).

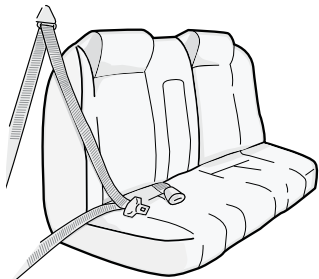
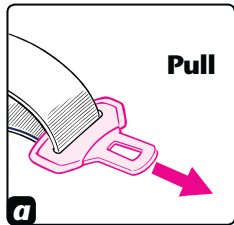

VEHICLE SEAT BELTS (continued)

Lap/Shoulder Belt with Emergency Locking Retractor (ELR) and Locking Latch Plate

The locking latch plate on some seat belts may slip and loosen after being buckled on child restraint if positioned at a certain angle. If this happens, flip the latch plate over **(a)** and re-buckle. Test installation again to see if this works. If not, move child restraint to another seating position.

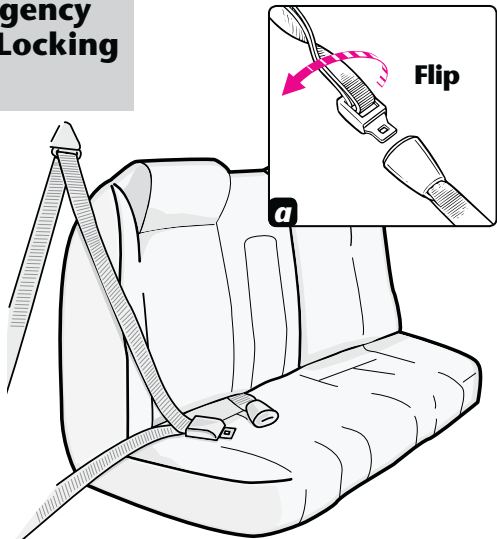

VEHICLE SEAT BELTS (continued)

Lap Belts - Manually Adjustable

The locking latch plate on some seat belts may slip and loosen after being buckled on child restraint if positioned at certain angle. If this happens, flip latch plate over **(a)** and re-buckle. Test installation again to see if this works. If not, move child restraint to another seating position.

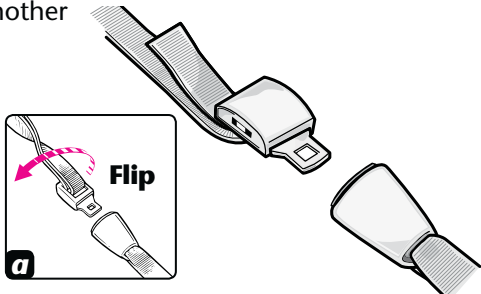

VEHICLE SEAT BELTS (continued)

Lap Belts - With Retractor

Lap belts with retractors may or may not hold a child restraint securely.

Follow these steps to determine if you have a retractor system that will hold child restraint securely:

- Pull belt all the way out
- Allow belt to retract about 6 inches (15cm)
- Slowly pull out on belt again.

If belt is locked and you **cannot** pull the belt out any further, you have an Automatic Locking Retractor which may be used with a child restraint. Remember, when installing a child restraint, pull belt all the way out, buckle belt, and then tighten.

If you **can** pull the belt out again (step c above), you must have an Emergency Locking Retractor which **MUST NOT** be used with a child restraint.

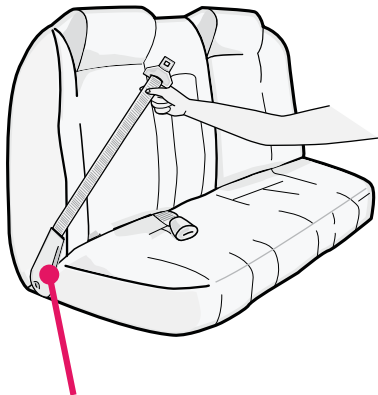

Retractor

VEHICLE SEAT BELTS (continued)

Lap/Shoulder Belt with Emergency Locking Retractor (ELR) and Sliding Latch Plate

Locking Clip

⚠ WARNING

Avoid serious injury or death:

- **Failure to use locking clip where required will result in child restraint not being securely held in place.**
- **Remove locking clip from seat belts when not being used with child restraint.**
- **DO NOT use locking clip as a vehicle seat belt shortener.**

You **MUST** use locking clip provided with child restraint with a vehicle seat belt that slides freely through the latch plate or the lap belt cannot be tightly secured.

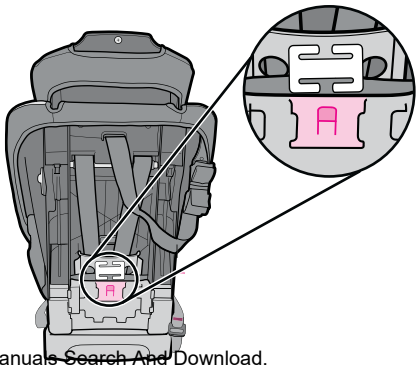

VEHICLE SEAT BELTS (continued)

1. Install child restraint and tighten vehicle seat belt.
2. Hold seat belts together at latch plate **(a)** then unbuckle.
3. If a locking clip is needed (see Pg. 49 "Locking Clip" section), slide locking clip on seat belts approximately 1/2 inch (1 cm) and up to 1 inch (2.5 cm) away from latch plate.
4. Re-buckle seat belt.
5. Test installation to see if child restraint is secure.

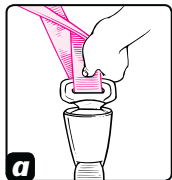

If not secure, additional belt tightening may be required:

- Unbuckle vehicle seat belt.
- Hold belts together and remove locking clip.
- Shorten length of lap belt portion slightly by pulling belt through latch plate
- Re-attach locking clip.
- Buckle vehicle seat belt.

Press child restraint further down into vehicle seat cushion to help buckle vehicle seat belt.

Test installation to see if child restraint is secure. If not secure, repeat above step until secure.

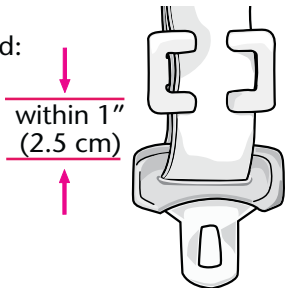

VEHICLE SEAT BELTS (continued)

Passive Restraint - Lap Belt with Motorized Shoulder Belt

DO NOT use with any child restraint.



Passive Restraint - Lap or Shoulder Belt Mounted on Door

DO NOT use with any child restraint.
Belts will not stay tight while driving.

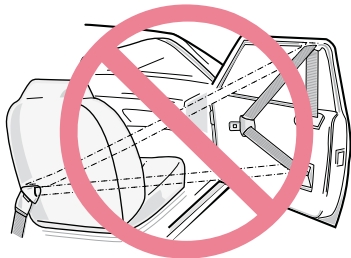

ADDITIONAL INFORMATION

Tether Storage

DO NOT anchor tether strap to vehicle when using child restraint *rear-facing*.

Tether hook must be attached to child restraint for *rear-facing* use or if vehicle is not equipped with tether anchors.

For storage of tether hook:

- Attach tether hook to back of child restraint as shown.
- Pull loose end of adjustment strap to remove any slack.
- Roll loose end of adjustment strap up and secure with a rubber band.

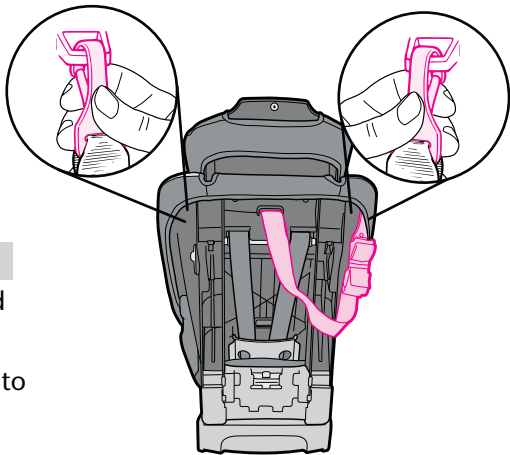

WARNING

To prevent ejection in sudden stop or crash:

- Never allow body support to bunch or fold behind child.
- Only use body support in *rear-facing* mode.
- Body support **MUST** be used if shoulders are below lowest harness setting.

Body Support (on certain models)



Head Pillow and Harness Covers (on certain models)

Flip body support and head pillow over. Slide head pillow under elastic strap on back of body support as shown **(a)**. Do not use head pillow and body support with any other product.

⚠ WARNING

To prevent serious head injury in sudden stop or crash:

- Make sure the harness system is properly secured.
- Check that the harness straps are not twisted.
- Make sure that harness covers do not interfere with placement of the chest clip at armpit level.

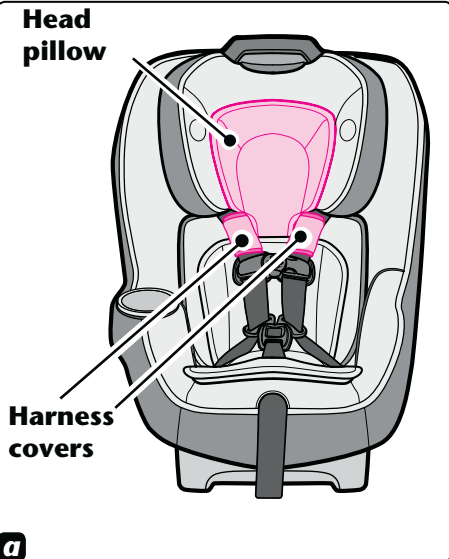

ADDITIONAL INFORMATION (continued)

Care and Cleaning

Refer to seat pad care tag for washing instructions.

Head Support Cover

Head Support Cover: clean with a damp sponge using mild soap and cool water. If necessary, cover may be removed for cleaning.

1. Remove head support cover as shown **(a)**.
2. Machine wash cover in cold water on delicate cycle and drip-dry. DO NOT USE BLEACH.
3. To put the head support cover back on, reverse preceding instructions.



ADDITIONAL INFORMATION (continued)

Care and Cleaning

Seat Pad

Seat Pad: clean with a damp sponge using mild soap and cool water. If necessary, seat pad may be removed for cleaning.

1. Loosen harness straps by lifting lever up **(a)** while pulling shoulder harness straps **(b)**.
2. Remove both harness strap loops from splitter plate on back of child restraint **(c)** and pull through front of pad. Open chest clip, release tongues from buckle.

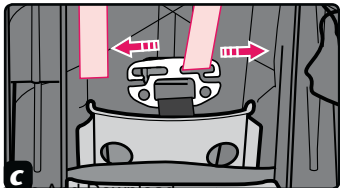
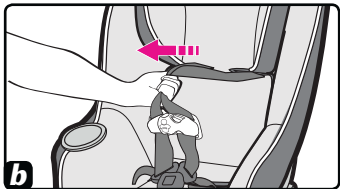
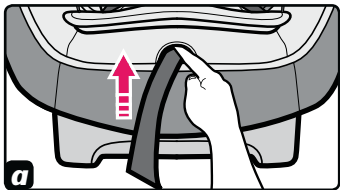

ADDITIONAL INFORMATION (continued)

3. Remove elastic straps from hooks on back of seat as shown **(d)**.
4. Remove 2-button clip at front of seat as shown **(e)**.
5. Remove seat pad from shell by pushing harness straps and crotch strap through seat pad.
6. Machine wash pad in cold water on delicate cycle and drip-dry. DO NOT USE BLEACH.
7. To put the seat pad back on, reverse preceding instructions.

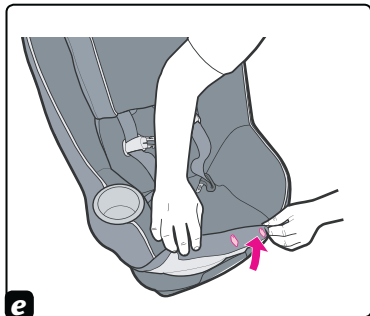
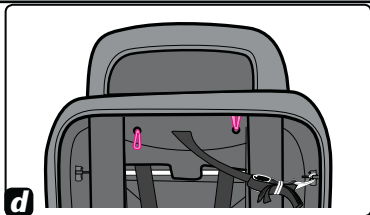

ADDITIONAL INFORMATION (continued)

Buckle Cleaning Process:

WARNING

Prevent serious injury or death:

- Buckle must be properly latched.
- Periodically inspect and clean buckle to remove objects or debris that could prevent latching.

1. Turn restraint over, push retainer through crotch strap slot **(a)**.
2. To clean buckle - place in a cup of warm water and gently agitate the buckle, press the red button several times while in the water **(b)**.
DO NOT SUBMERGE THE HARNESS WEBBING. DO NOT USE SOAPS or LUBRICANTS. DO NOT use household detergents. Never lubricate buckle.
3. Shake out excess water and allow to air dry, harness webbing should be dry before use **(c)**.
4. Repeat Step 2 and 3 as needed. Buckle should fasten with a "click".
5. Re-attach buckle into the same slot from Step 1.
Re-check harness for correct installation before use.

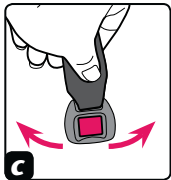
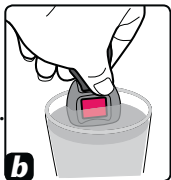
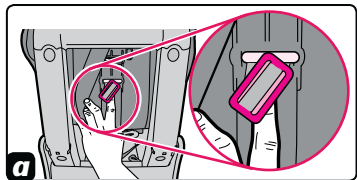

ADDITIONAL INFORMATION (continued)

Harness Straps &

LATCH Belt:

Surface wash only with mild soap and damp cloth. DO NOT IMMERSE THE HARNESS STRAPS or **LATCH** BELT IN WATER, doing so may weaken the harness straps or **LATCH** belt.

If harness straps or **LATCH** belt are frayed or heavily soiled, they **MUST** be replaced.

Aircraft Use

This child restraint is certified for use on aircraft (see label on child restraint). Contact airline about their policy.

Use this child restraint only on forward-facing aircraft seats.

Install child restraint on an aircraft the same way it is installed in a vehicle when using a vehicle seat belt.

Second Hand Child Restraint

Graco Children's Products Inc. advises against loaning or passing along a child restraint.

REPLACEMENT PARTS

To purchase parts or accessories in the United States,
please contact us at the following:

www.gracobaby.com

or

1-800-345-4109

Store instruction
manual in the
slot with the
instruction book
icon as shown.

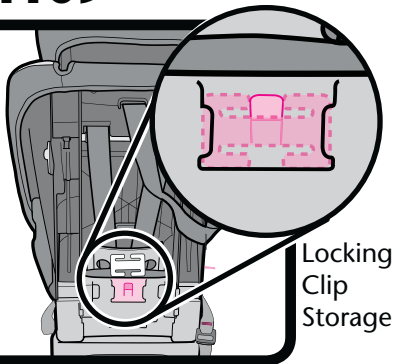
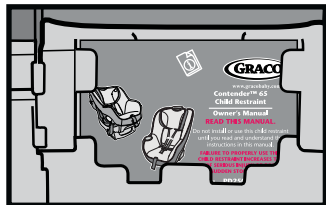

Locking
Clip
Storage

Free Manuals Download Website

<http://myh66.com>

<http://usermanuals.us>

<http://www.somanuals.com>

<http://www.4manuals.cc>

<http://www.manual-lib.com>

<http://www.404manual.com>

<http://www.luxmanual.com>

<http://aubethermostatmanual.com>

Golf course search by state

<http://golfingnear.com>

Email search by domain

<http://emailbydomain.com>

Auto manuals search

<http://auto.somanuals.com>

TV manuals search

<http://tv.somanuals.com>