

# Operation and Maintenance



## PR70<sup>TM</sup>

### 2 Component Liquid Dispensing Systems

312393J  
EN

#### PR70 All Models

*3000 psi (21 MPa, 207 bar) Maximum Working Pressure*  
*100 PSI (0.7 MPa, 7 bar) Maximum Air Inlet Pressure*

For Dispensing Multi-part Sealants and Adhesives.  
Not Designed for Use in Explosive Atmospheres.



#### Important Safety Instructions

Read all warnings and  
instructions in this manual.

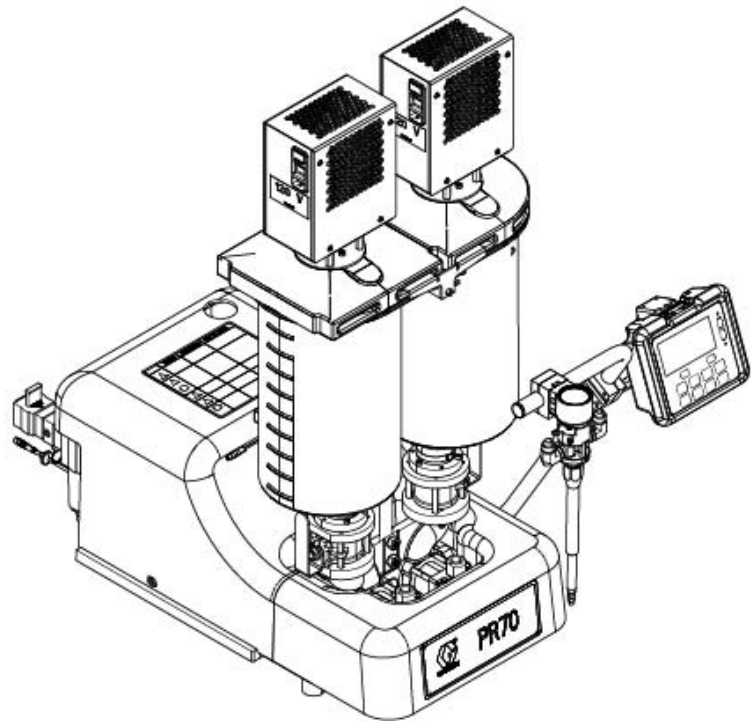

# Contents

<b>Contents</b> .....	<b>2</b>	<i>Tank Level Sensing and Velocity Change (“<math>\Delta V</math>”)</i> <i>Options (C6)</i> .....	<b>19</b>
<i>PR70 Accessories</i> .....	<b>3</b>	<b>Password Setup / Clearing (C5)</b> .....	<b>20</b>
<b>Supplied Manuals</b> .....	<b>4</b>	<i>Setting/Clearing an Administrative Password:</i> .....	<b>20</b>
<b>Related Manuals</b> .....	<b>4</b>	<i>Setting/Clearing a Maintenance ONLY Password:</i>	<b>21</b>
<b>Warnings</b> .....	<b>5</b>	<i>Resetting Passwords</i> .....	<b>21</b>
<b>Installation</b> .....	<b>7</b>	<b>Miscellaneous Machine Features</b> .....	<b>22</b>
<i>General Information</i> .....	<b>7</b>	<i>HMI Hibernate Mode</i> .....	<b>22</b>
<i>Unpacking</i> .....	<b>7</b>	<i>HMI Startup Animation Sequence</i> .....	<b>22</b>
<i>Locate and Install the PR70</i> .....	<b>7</b>	<i>HMI Demo Mode Operation</i> .....	<b>22</b>
<i>Machine Setup</i> .....	<b>7</b>	<b>Pressure Relief Procedure</b> .....	<b>23</b>
<b>Component Identification</b> .....	<b>8</b>	<b>Standby/Shutdown Procedure</b> .....	<b>23</b>
<b>HMI Control and Indicators</b> .....	<b>9</b>	<b>Error Codes</b> .....	<b>23</b>
<i>HMI Main Run Screen</i> .....	<b>10</b>	<b>Error Code Table</b> .....	<b>24</b>
<b>Run Screen Operation</b> .....	<b>10</b>	<b>ICON Descriptions</b> .....	<b>26</b>
<i>Machine Mode Selection</i> .....	<b>10</b>	<b>Maintenance</b> .....	<b>28</b>
<i>Machine Operation: Shot Mode</i> .....	<b>10</b>	<b>Software Upgrades, Run Token</b> .....	<b>28</b>
<i>Machine Operation: Operator Mode</i> .....	<b>10</b>	<i>Run Token</i> .....	<b>28</b>
<i>Shot Number Selection</i> .....	<b>10</b>	<b>Troubleshooting</b> .....	<b>29</b>
<b>Machine Disable Mode (“”red)</b> .....	<b>11</b>	<b>Repair</b> .....	<b>30</b>
<b>Setup Screens</b> .....	<b>11</b>	<i>Major Mechanical Assemblies, and Attachments</i>	<b>30</b>
<i>Entering the Setup Screens</i> .....	<b>11</b>	<i>Base Frame Assembly</i> .....	<b>31</b>
<i>Setup Screens with Passwords Enabled</i> .....	<b>11</b>	<i>Air Cylinder Assemblies, and Rebuild Kits</i> .....	<b>32</b>
<b>Machine Priming</b> .....	<b>13</b>	<i>Drive Block Assembly</i> .....	<b>35</b>
<b>Machine Calibration</b> .....	<b>13</b>	<i>Pump Assemblies and Rebuild Kits</i> .....	<b>35</b>
<i>Piston Position Calibration (C1)</i> .....	<b>13</b>	<i>Piston Cylinders or Metering Tubes</i> .....	<b>38</b>
<i>Phasing (C2)</i> .....	<b>14</b>	<i>Hose Assemblies</i> .....	<b>41</b>
<i>Open Dispense Valve (ODV) Setting (C3)</i> .....	<b>14</b>	<i>Miscellaneous Mechanical Assemblies</i> .....	<b>43</b>
<i>Machine Calibration Shots (C4)</i> .....	<b>15</b>	<b>Wiring Diagrams</b> .....	<b>46</b>
<b>Shot Size Definition (M2)</b> .....	<b>16</b>	<b>Technical Data</b> .....	<b>48</b>
<b>Ratio Checks</b> .....	<b>16</b>	<b>Dimensions</b> .....	<b>49</b>
<b>Miscellaneous Machine Setups</b> .....	<b>17</b>	<b>Graco Ohio Standard Warranty</b> .....	<b>50</b>
<i>Manual Control Options (M1)</i> .....	<b>17</b>	<b>Graco Information</b> .....	<b>50</b>
<i>Purge Timer / Alarm Settings (M2)</i> .....	<b>17</b>		
<i>Cycle Counter and Silent Mode Control (M3)</i> .....	<b>18</b>		
<i>Date and Time Settings (M4)</i> .....	<b>19</b>		

## Models

### PR70 Accessories

#### Mixer and Shroud Options

LC0063	Mixer, 3/16 (6.5 mm) x 32, 10 Mixers with shroud	LC0081	Mixer, 3/8 (9.8 mm) combo, 50 Mixers
LC0057	Mixer, 1/4 (6.5 mm) x 24, 10 Mixers with shroud	LC0083	Mixer, 1/4 (6.5 mm) x 24 Luer Lock, 50 Mixers
LC0058	Mixer, 3/8 (9.8 mm) x 24, 10 Mixers with shroud	LC0082	Mixer, 3/16 (4.8 mm) x 32 Luer Lock, 50 Mixers
LC0059	Mixer, 3/8 (9.8 mm) x 36, 10 Mixers with shroud	LC0084	Mixer, 3/16 (4.8 mm) x 32, 250 Mixers
LC0060	Mixer, 3/8 (9.8 mm) Combo, 10 Mixers with shroud	LC0085	Mixer, 1/4 (6.5 mm) x 24, 250 Mixers
LC0061	Mixer, 3/16 (4.8 mm) x 32 Luer Lock, 10 Mixers with shroud	LC0086	Mixer, 3/8 (9.8 mm) x 24, 250 Mixers
LC0062	Mixer, 1/4 (6.5 mm) x 24 Luer Lock, 10 Mixers with shroud	LC0087	Mixer, 3/8 (9.8 mm) x 36, 250 Mixers
LC0077	Mixer, 3/16 (4.8 mm) x 32, 50 Mixers	LC0088	Mixer, 3/8 (9.8 mm) combo, 250 Mixers
LC0078	Mixer, 1/4 (6.5 mm) x 24, 50 Mixers	LC0089	Mixer, 3/16 (4.8 mm) x 32 Luer Lock, 250 Mixers
LC0079	Mixer, 3/8 (9.8 mm) x 24, 50 Mixers	LC0090	Mixer, 1/4 (6.5 mm) x 24 Luer Lock, 250 Mixers
LC0080	Mixer, 3/8 (9.8 mm) x 36, 50 Mixers		

#### MD2 Valve Kits

255217	MDS2, kit rebuild, air cylinder	255219	MD2, Soft Seat rebuild, needle and nose
255218	MD2, kit rebuild, back-end of wet section (no needle or seat)	255220	MD2, convert Soft Seat nose to Hard Seat (Hard Seat rebuild), needle and nose

#### Other Accessories

LC0097	Desiccant Dryer, 3/8" NPT with adapter and cartridge	LC0100	Vacuum Transfer Pump, 240V, down to 25 Torr
LC0098	Desiccant Dryer refill cartridge	LC0091	3.0" Air Cylinder rebuild kit
LC0095	Nitrogen Kit for 30L and 60L tank, 1 tank	LC0092	4.5" Air Cylinder rebuild kit
LC0096	Nitrogen Kit for 30L and 60L tank, 2 tanks	LC0093	Check Valve rebuild kit
LC0008	Cord, I/O interface and footswitch part	LC0094	Rear Pump Seal rebuild kit
LC0099	Vacuum Transfer Pump, 120V, down to 25 Torr		

## Supplied Manuals

The following manuals will be supplied with the PR70.

Refer to these documents for detailed machine information.

<b>PR70 Operation</b>	
Part	Description
312393	Manual, Operation & Maintenance PR70
<b>PR70 Feed System</b>	
Part	Description
312394	Manual, Tank/Feed System, PR70
<b>Dispense Valve, MD2</b>	
Part	Description
312185	Manual, Dispense Valve, MD2
<b>* Heat Control Module(s)</b>	
Part	Description
312413	Manual, Heat Control, Tank/Hoses

## Related Manuals





The following manuals are for accessories to be used with the PR70 machine.

<b>PR70 Operation</b>	
Part	Description
312393	Manual, Operation & Maintenance PR70
<b>PR70 Feed System</b>	
Part	Description
312394	Manual, Tank/Feed System, PR70
<b>Dispense Valve, MD2</b>	
Part	Description
312185	Manual, Dispense Valve, MD2
<b>Heat Control Module(s)</b>	
Part	Description
312413	Manual, Heat Control, Tank/Hoses

- \* The Heat Control Module manual is not provided for machines that do not have a Heated Tank and/or Hose component.

## Warnings

The following warnings are for the setup, use, grounding, maintenance, and repair of this equipment. The exclamation point symbol alerts you to a general warning and the hazard symbol refers to procedure-specific risk. Refer back to these warnings. Additional, product-specific warnings may be found throughout the body of this manual where applicable.

 <b>WARNING</b>	
	<p><b>ELECTRIC SHOCK HAZARD</b></p> <p>Improper grounding, setup, or usage of the system can cause electric shock.</p> <ul style="list-style-type: none"> <li>• Turn off and disconnect power cord before servicing equipment.</li> <li>• Use only grounded electrical outlets.</li> <li>• Use only 3-wire extension cords.</li> <li>• Ensure ground prongs are intact on sprayer and extension cords.</li> <li>• Do not expose to rain. Store indoors.</li> </ul>
	<p><b>SKIN INJECTION HAZARD</b></p> <p>High-pressure fluid from dispense valve, hose leaks, or ruptured components will pierce skin. This may look like just a cut, but it is a serious injury that can result in amputation. <b>Get immediate surgical treatment.</b></p> <ul style="list-style-type: none"> <li>• Do not point dispense valve at anyone or at any part of the body.</li> <li>• Do not put your hand over the end of the dispense nozzle.</li> <li>• Do not stop or deflect leaks with your hand, body, glove, or rag.</li> <li>• Follow <b>Pressure Relief Procedure</b> in this manual, when you stop spraying and before cleaning, checking, or servicing equipment.</li> </ul>
	<p><b>TOXIC FLUID OR FUMES HAZARD</b></p> <p>Toxic fluids or fumes can cause serious injury or death if splashed in the eyes or on skin, inhaled, or swallowed.</p> <ul style="list-style-type: none"> <li>• Read MSDS's to know the specific hazards of the fluids you are using.</li> <li>• Store hazardous fluid in approved containers, and dispose of it according to applicable guidelines.</li> <li>• Always wear impervious gloves when spraying or cleaning equipment.</li> </ul>
	<p><b>FIRE AND EXPLOSION HAZARD</b></p> <p>Flammable fumes, such as solvent and paint fumes, in work area can ignite or explode. To help prevent fire and explosion:</p> <ul style="list-style-type: none"> <li>• Use and clean equipment only in well ventilated area.</li> <li>• Eliminate all ignition sources; such as pilot lights, cigarettes, portable electric lamps, and plastic drop cloths (potential static arc).</li> <li>• Keep work area free of debris, including solvent, rags and gasoline.</li> <li>• Do not plug or unplug power cords or turn lights on or off when flammable fumes are present.</li> <li>• Ground equipment, personnel, object being sprayed, and conductive objects in work area. See <b>Grounding</b> instructions.</li> <li>• Use only Graco grounded hoses.</li> <li>• Check gun resistance daily.</li> <li>• If there is static sparking or you feel a shock, <b>stop operation immediately</b>. Do not use equipment until you identify and correct the problem.</li> <li>• Do not flush with gun electrostatics on. Do not turn on electrostatics until all solvent is removed from system.</li> <li>• Keep a working fire extinguisher in the work area.</li> </ul>

 **WARNING**
**EQUIPMENT MISUSE HAZARD**

Misuse can cause death or serious injury.

- Do not operate the unit when fatigued or under the influence of drugs or alcohol.
- Do not exceed the maximum working pressure or temperature rating of the lowest rated system component. See **Technical Data** in all equipment manuals.
- Use fluids and solvents that are compatible with equipment wetted parts. See **Technical Data** in all equipment manuals. Read fluid and solvent manufacturer's warnings. For complete information about your material, request MSDS forms from distributor or retailer.
- Check equipment daily. Repair or replace worn or damaged parts immediately with genuine manufacturer's replacement parts only.
- Do not alter or modify equipment.
- Use equipment only for its intended purpose. Call your distributor for information.
- Route hoses and cables away from traffic areas, sharp edges, moving parts, and hot surfaces.
- Do not kink or over bend hoses or use hoses to pull equipment.
- Keep children and animals away from work area.
- Comply with all applicable safety regulations.

**MOVING PARTS HAZARD**

Moving parts can pinch or amputate fingers and other body parts.

- Keep clear of moving parts.
- Do not operate equipment with protective guards or covers removed.
- Pressurized equipment can start without warning. Before checking, moving, or servicing equipment, follow the **Pressure Relief Procedure** in this manual. Disconnect power or air supply.

**PERSONAL PROTECTIVE EQUIPMENT**

You must wear appropriate protective equipment when operating, servicing, or when in the operating area of the equipment to help protect you from serious injury, including eye injury, inhalation of toxic fumes, burns, and hearing loss. This equipment includes but is not limited to:

- Protective eyewear
- Clothing and respirator as recommended by the fluid and solvent manufacturer
- Gloves
- Hearing protection

## Installation

### General Information

Accessories are available from Graco. Make certain all accessories are adequately sized and pressure-rated to meet your system needs.

Figures 2 thru 4 are only a guide for identifying system components and for assisting in installation. Contact your Graco distributor or Graco Ohio Customer Service for assistance in designing a system to suit your particular needs.

### Unpacking

1. Inspect the shipping container carefully for damage. Contact the carrier promptly if there is damage.
2. Open the box and inspect the contents carefully. There should not be any loose or damaged parts in the container.
3. Compare the packing slip against all the items in the box. Report any shortage or other inspection problems immediately.
4. Remove the PR70 system components from the container. Do not lift the machine by the tanks.

### Locate and Install the PR70

1. Locate a bench top or equivalent location to mechanically mount the PR70 dispensing machine.

Verify the location has access to compressed air, AC power and is well ventilated.

2. Place the PR70 onto the designated location. Allow to the machine to rest on the rubber feet provided.
3. Turn the Shield Locking Screws clockwise on both sides to remove the PR70 protective shield.
4. Attach the PR70 frame to the selected location by installing fasteners (not provided with unit) thru the 4 mounting holes. Refer to Figure 1 for mounting hole dimensions.

### Machine Setup



1. Connect a compressed airline to the input air in the back of the machine.
2. Load material into the on-board or off-board tanks feeding the machine.
3. Using the power cord provided, connect AC power (100-240V, 50/60 Hz, single-phase) to the machine.

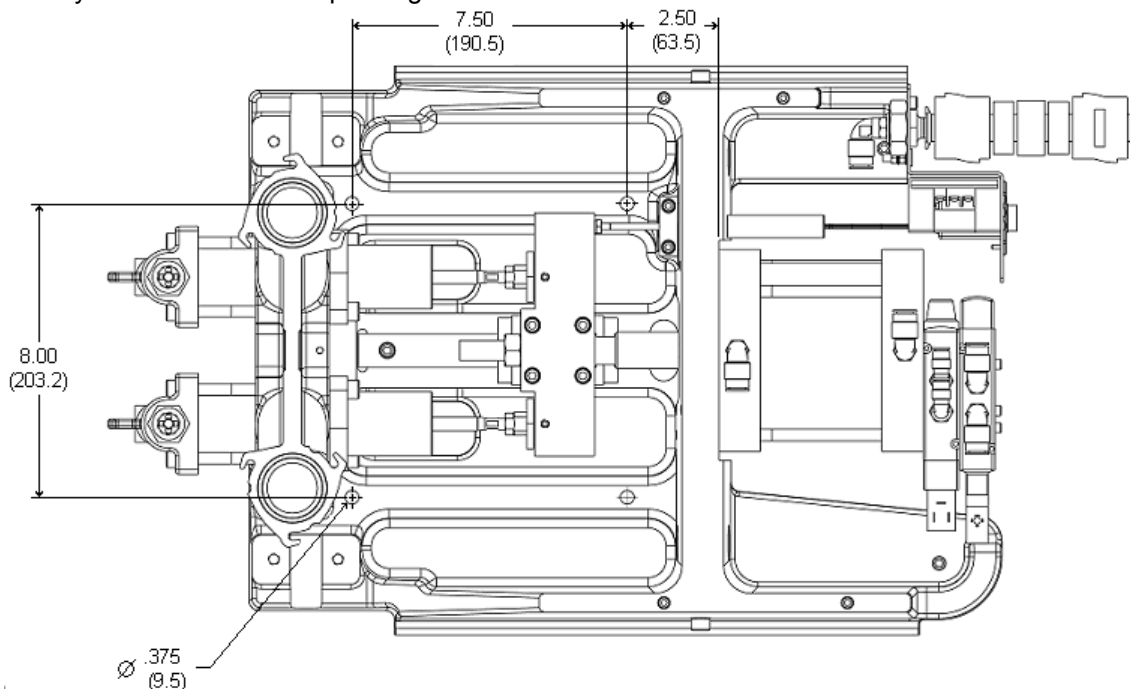

**Figure 1: Mounting Hole Dimensions for Installing the PR70 Machine (dimensions in inches/mm)**

## Component Identification

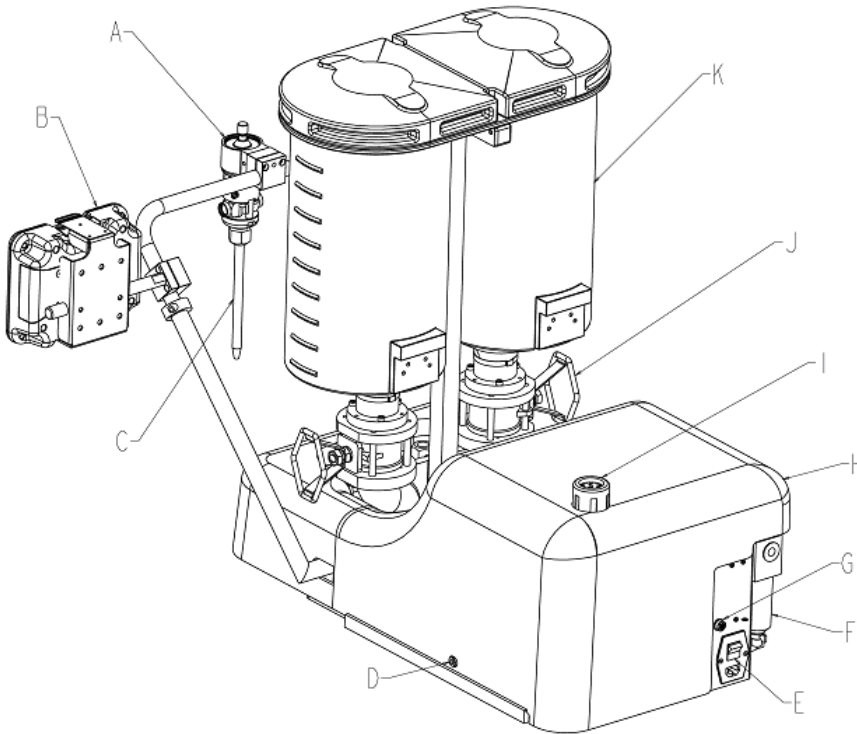

**Key:**

- A Dispense Valve (DV)
- B HMI (Human Machine Interface)
- C Static Mixer
- D Shield Locking Screw
- E Power Switch
- F Air Filter
- G Customer Input Receptacle
- H Protective Shield
- I Air Pressure Regulator
- J Ball Valve (Optional)
- K A and B Tanks (Onboard, Polyethylene versions illustrated).

Figure 2: Typical PR70 (Back View, without Hoses)

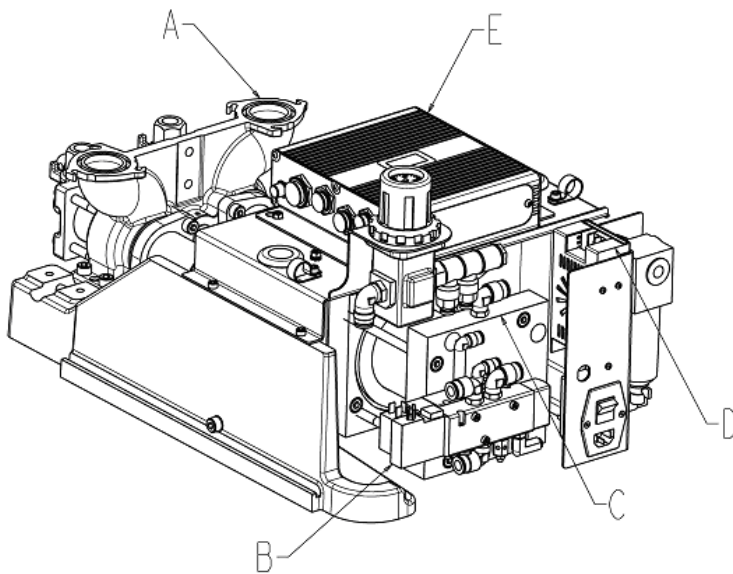

**Key:**

- A Pump Assembly
- B Solenoid Valves
- C Air Cylinder Assembly
- D DC Power Supply
- E Fluid Control Module (FCM)

Figure 3: PR70 Back View with Shield, Tanks, DV and HMI Removed.



## Component Identification

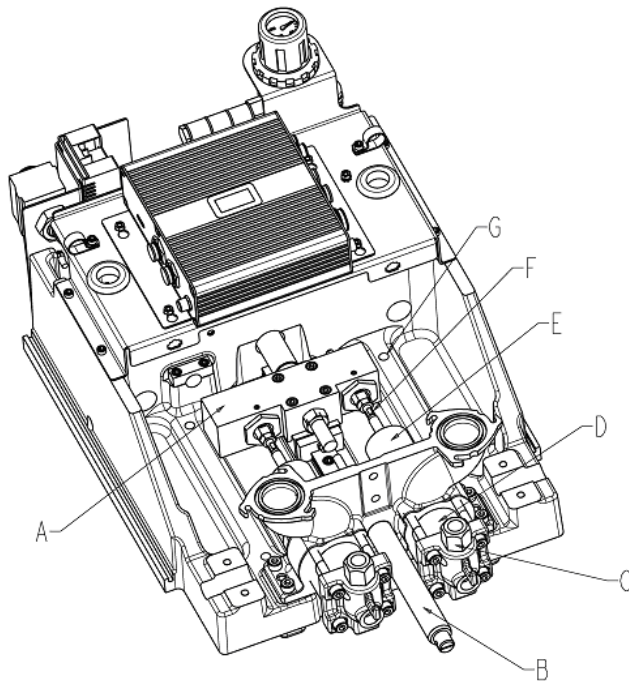

### Key:

- A Drive Block
- B Hydracheck (optional)
- C Check Valve
- D Cylinder (Metering Tube)
- E Rear Bearing
- F Phase Adjustment Screw/Locking Nut
- G Mounting Hole in Base Frame

Figure 4: PR70 Top View with Shield, Tanks, DV and HMI Removed.

## HMI Control and Indicators

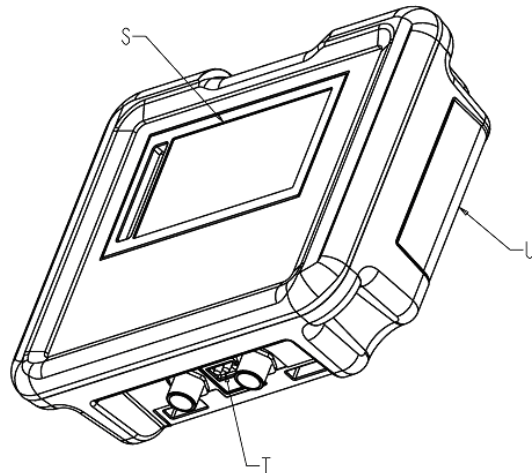
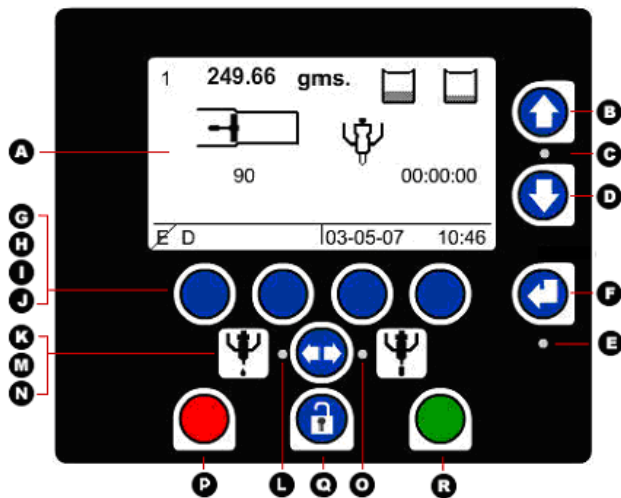

Figure 5: PR70 HMI Controls

### Key:

- |      |                                     |   |   |
|------|-------------------------------------|---|---|
| A    | Screen, Display Area                | N | Operator Mode ICON  |
| B, D | Up and Down Keys                    | O | Operator Mode LED   |
| C    | Up and Down Key LED                 | P | Red Stop or Cancel Key (used to stop machine operation)                             |
| E    | Enter Key LED                       | Q | Lock Key (used to enter and exit setup screens)                                     |
| F    | Enter Key                           | R | Green Go Key (used to request a shot)   |
| G-J  | Soft Keys 1 thru 4 (Left to Right). | S | Display area  |
| K    | Shot Mode ICON                      | T | Diagnostic LED's  |
| L    | Shot Mode LED                       | U | HMI Rear Access Panel (used to access clock battery and for reprogramming the HMI). |
| M    | Mode Select Key                     |   |   |

### HMI Main Run Screen

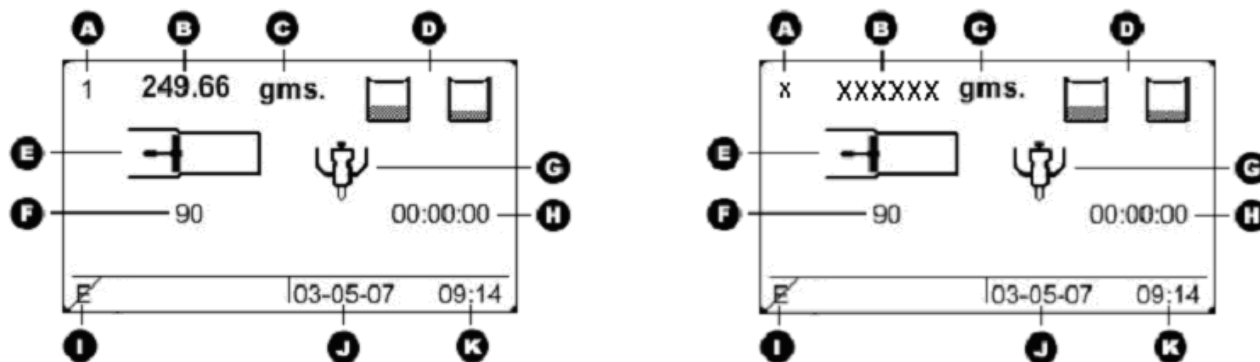

Figure 6: Typical PR70 Main Run Screen (Shot and Operator Modes) Respectively)

**Key:**

- |   |                                      |
|---|--------------------------------------|
| A Shot Number Field ("x" in Operator Mode)    | F Cycle Counter                      |
| B Shot Size Field ("XXXXXX" in Operator Mode) | G DV status Field                    |
| C Shot weight/mass unit of measure (Grams).   | H Purge Timer status Field           |
| D Tank Fill Status Indicators                 | I Error code status Field            |
| E Pistons Status Field                        | J Current Date Field (DD-MM-YY)      |
|   | K Current Time Field (24 Hr. Format) |

### Run Screen Operation

Read all manufacturer's warning and material MSDS to know the specific hazards of the material used.				

#### Machine Mode Selection

To dispense material, one of the following 2 modes must be selected;

- **Shot mode** dispenses a predetermined amount of material when the machine receives a "Go" command.
- **Operator mode** dispenses material as long as the machine is receiving a "Go" command.

To select Shot mode:

1. Press until .
2. Press to accept or to cancel.

To select Operator mode:

3. Press until .
4. Press to accept or to cancel.

#### Machine Operation: Shot Mode

1. Place the item or part to be filled below the dispense valve static mixer
2. Press (green) or the footswitch to start the shot.

3. To cancel the shot, press .

#### Machine Operation: Operator Mode

1. Place the item or part to be filled below the dispense valve static mixer.
2. Press and hold (green) or the footswitch to start the shot. The machine will continue to dispense until the (green) or the footswitch is released.

The pistons will not retract unless they are almost fully extended. They will automatically retract after 4 minutes. The machine will beep to signal that it is about to retract. To manually retract the machine, press .

#### Shot Number Selection

In Shot mode, up to 5 predefined shot sizes may be selected. To select a shot:

1. When the machine is idle (not dispensing a shot) press or to select the new shot size.
2. Press to accept, or to cancel.

## Machine Disable Mode (“●”red)

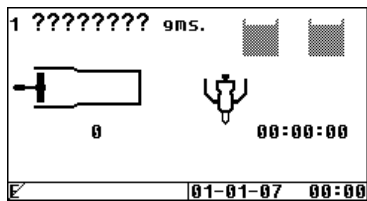

**Figure 6: Typical Run Screen when Machine in “Disable” Mode**

1. At any time and from any screen, to immediately disable all machine motion, press ● (red).
2. If activated, the purge timer will be disabled
3. To resume operation, the machine must be put back into an operating mode as described in the Machine Mode Selection section.
4. If activated, the purge timer will not restart until a shot is taken.

## Setup Screens

Before the machine will operate properly, it must be calibrated and shot size information must be entered.

### Entering the Setup Screens

1. From the Run screen press 🔒. If no password has been programmed into the HMI, the Programming Mode Selection Screen (Figure 7) will be displayed.

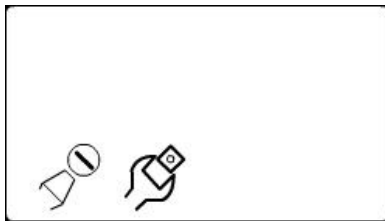
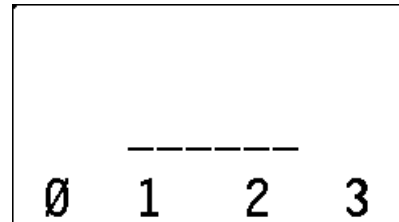

**Figure 7: Programming Mode Selection Screen**

2. To enter the calibration screens, press 🔧. To enter the maintenance screens, press 🔧. Refer to Figure 9 for a screen navigation diagram.

### Setup Screens with Passwords Enabled

1. From the Run screen press 🔒. If a password has been programmed, the Password Entry Screen (Figure 8) will be displayed.



**Figure 8: Password Entry Screen**

2. Enter the 6 digit password by pressing the corresponding soft keys, G-J in Figure 5.
3. After the 6<sup>th</sup> digit has been entered, press ↵.
4. If the correct password has been entered, the Programming Mode Selection Screen will be displayed. Refer to Figure 9 for a screen navigation diagram.
5. If the incorrect password has been entered, the password entry will need to be repeated until the correct 6-digit sequence is entered.
6. To abort the password entry, press 🔒.

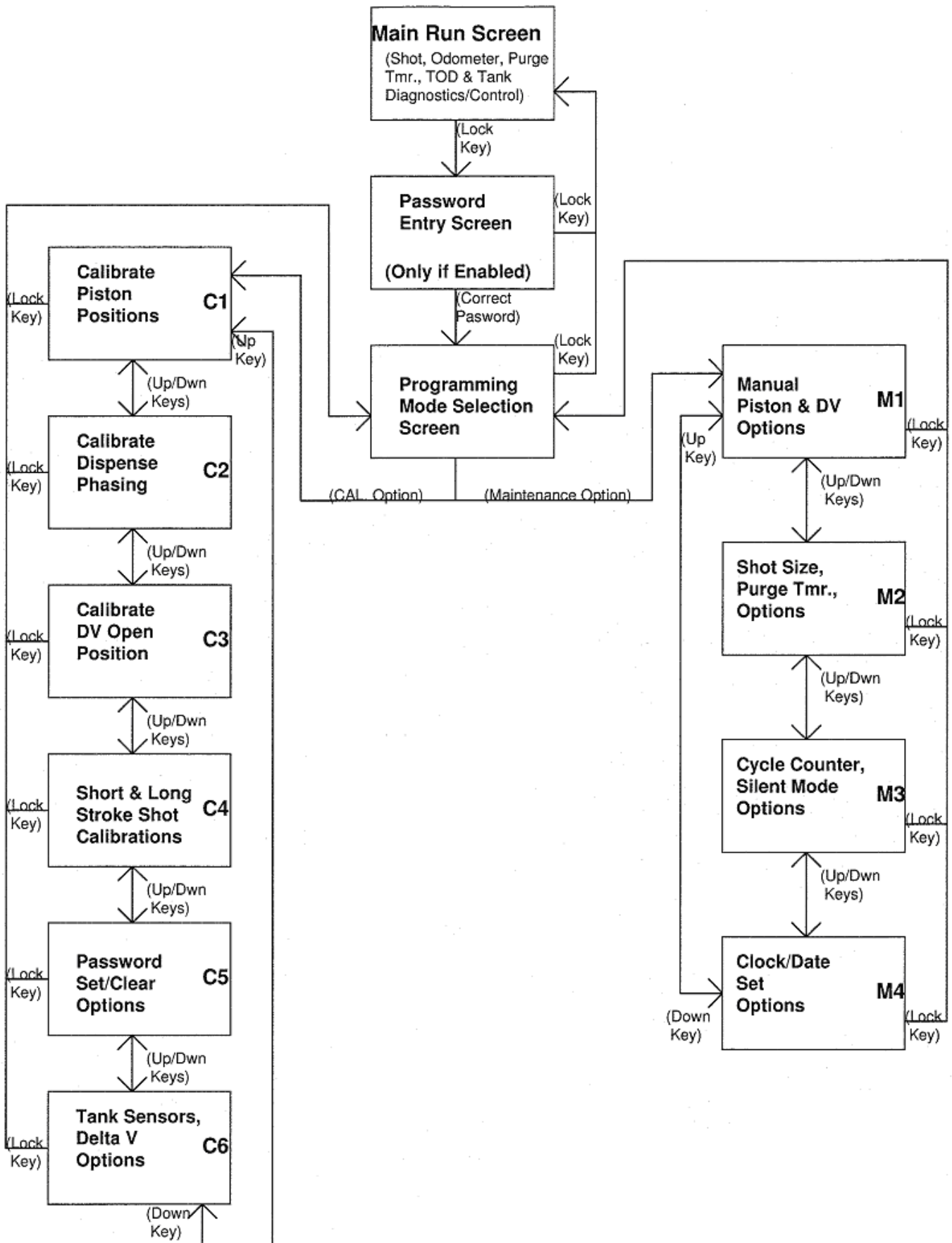

Figure 9: PR70 Screen Navigation Diagram

## Machine Priming

Before the machine can be properly calibrated with material, it will need to be primed.



From the Run Screen press then press . The following screen will be displayed.

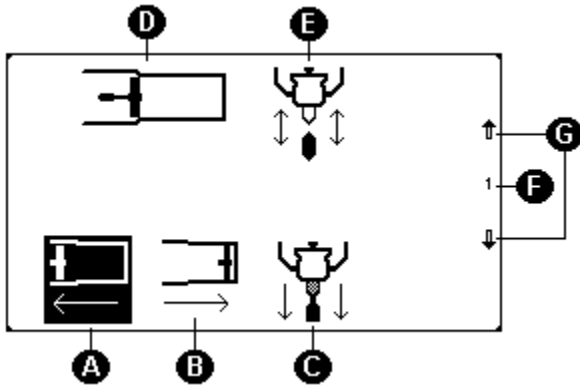

Figure 10: Maintenance Screen for Priming (M1)

### Key:

- A Full Retract ICON
- B Full Extend ICON
- C Change Dispense Valve Mode
  - = Always Open
  - = Always Closed
  - = Opens at Cylinder Entrance (Automatic)
- D Current Piston Position
- E Current Dispense Valve Mode
- F Screen Number (C1)
- G & keys will navigate to adjacent screens.

1. Place a waste container under the dispense valve to capture any dispensed material.
2. Press until the upper ICON is .
3. Press to extend the piston fully.
4. Press to retract the piston fully.
5. Repeat steps 3 and 4 until both materials dispense from the valve without air.
6. Press twice to return to the Run screen.

## Machine Calibration

Before the machine will accurately dispense, it must be calibrated.



### Piston Position Calibration (C1)

This step should be executed the 1<sup>st</sup> time the machine is setup, and may not need to be re-executed unless the position sensor, an electronic component or a piston has been replaced.

From the Run Screen press then press . The following screen will be displayed.

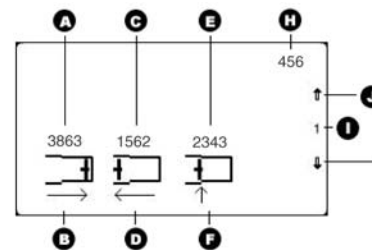





Figure 11: Piston Position Calibration Screen (C1)

### Key:

- A Full Extend position number from last calibration
- B Full Extend Command ICON
- C Full Retract position number from last calibration
- D Full Retract Command ICON
- E Cylinder Entrance position from last calibration
- F Cylinder Entrance Command ICON
- H Current Piston Position Field
- I Screen Number (C1)
- J & keys will navigate to adjacent screens.

1. Place a waste container under the dispense valve to capture any dispensed material.
2. With air pressure applied to the machine, press .
3. The piston should fully extend and a number between 3600 to 3900 should appear for 'H'
4. Press to accept the number or to keep the current number.
5. Press .
6. The piston should fully retract and a number between 1250 to 1600 should appear for 'H'.
7. Press to accept the number or to keep the current number.
8. Decrease the air pressure by adjusting the machine air pressure regulator to a minimal value (i.e. ~ 10 - 20 psi).
9. Press .



## Priming and Calibration

- The machine pistons should extend slowly until they encounter the cylinder entrance and a number between 2000 to 2400 should appear for 'H'.
- If the pistons do not move, manually move the piston by pulling on the machine drive block, until mechanical resistance is encountered at the cylinder entrance.
- Press  to accept the number or  to keep the current number.
- Adjust the Air Pressure Regulator back to a reasonable value for proper machine operation.
- Press  twice to return to the Run screen.

## Phasing (C2)

To enable the machine to dispense the correct ratio of material from the A and B tanks and to mix properly, both materials will need to enter the static mixer at the same time. Phasing shots will need to be executed to visually verify that the 2 materials are exiting the dispense valve at the same time.

Remove any static mixer attached to the dispense valve, and replace it with a ratio check nozzle. Place a waste container under the valve to capture any dispensed material.

From the Run screen, press , then press , and then press  once. The following screen will be displayed.

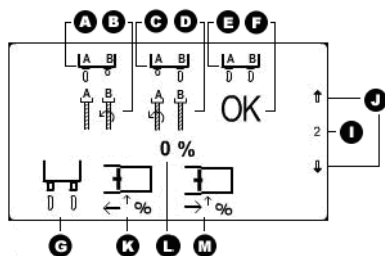

















Figure 12: Phasing Calibration Screen (C2)

### Key:

- A A material leads B ICON
- B Adjust B side Forward ICON
- C B material leads A ICON
- D Adjust A side Forward ICON
- E A and B Exit the Same Time ICON
- F Do NO Mechanical Adjustment ICON
- G Phase Shot Request ICON
- I Screen Number (C2)
- J  &  keys will navigate to adjacent screens.
- K Decrease Phase Shot Percentage Amount ICON
- L Current Phase Shot Percentage Amount
- M Increase Phase Shot Percentage Amount ICON

- Select the location where the piston will reverse (from the extend to retract motion) by pressing % or % keys. Pressing % will decrease the phasing shot. Pressing % will increase the phasing shot. A "+" value indicates that the piston will reverse beyond the cylinder entrance. A "-" value indicates the piston will reverse prior to reaching the cylinder entrance.
- Press  (green) or the footswitch.
- During the shot execution, visually monitor the 2 materials exiting the ratio check nozzle. If the timing of the 2 materials exiting the nozzle cannot be properly observed, press % or % accordingly, then repeat step 2.
- If the A side material exits the ratio nozzle before the B side material (, "0 0"), turn the B piston Phase Adjustment Screw/ Locking nut and shaft counterclockwise to move the B piston forward, as indicated on the  ICON. Slight adjustments in the piston shaft will be significant. Adjustments of a quarter turn are typical.
- If the B side material exits the ratio nozzle before the A side material (, "0 0"), turn the A piston Phase Adjustment Screw/ Locking nut and shaft counterclockwise to move the A piston forward, as indicated on the  ICON.
- Repeat step 2 until both materials exit the ratio check nozzle at the same time (, "0 0").
- Press  twice to return to the Run screen.

## Open Dispense Valve (ODV) Setting (C3)

The next step in the calibration process is to determine the proper position to open the Dispense Valve (DV) during the shot.

Advancing or increasing the opening position (in millimeters) will build more pressure in the material hoses prior to the dispense valve opening. If the Dispense Valve opens too late in the shot, a surge of material can occur or the piston could stall. If the Dispense Valve opens too early in the shot, material "drooling" at the beginning of the dispense cycle could occur.

From the Run screen, press , then press , and then press  2 times. The following screen will be displayed.

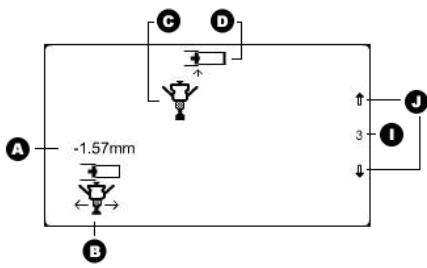

**Figure 13: Open Dispense Valve (ODV) Screen (C3)**

**Key:**

- A Current ODV Adjustment (in mm from the cylinder entrance).
- B Adjust ODV value Option ICON.
- C Relative ODV Position ICON with respect to cylinder entrance (This ICON will move right or left at +/- mm transition).
- D Cylinder Entrance ICON (stationary).
- I Screen Number (C3)
- J & keys will navigate to adjacent screens.

1. To adjust the ODV position with respect to the cylinder entrance, press .
2. Press to increase the value or to decrease the value. Values of - 5.0 mm to + 5.0 mm are allowed.
3. Press to accept the value or to retain the previous value. The default value from the factory is - 1.0 mm.
4. Press twice to return to the Run screen.

**Machine Calibration Shots (C4)**

Read all manufacturer's warning and material MSDS to know the specific hazards of the material used.				

Calibration shots are necessary to program the machine to properly dispense the correct amount of material. Several short CAL shots () and several long CAL shots () are required.

Remove the ratio check nozzle, install the static mixer intended to be used, and adjust the air pressure to the level intended for use during normal operation.



The air pressure must be set to operating conditions for this step. Significant changes in air pressure could adversely affect shot accuracy.

From the Run screen, press , then press , then press 3 times. The following screen will be displayed.

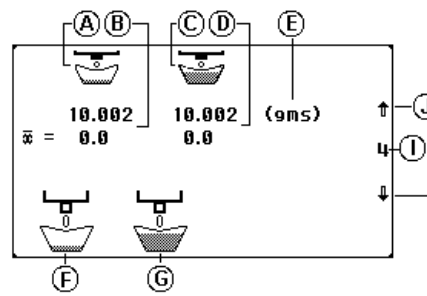













**Figure 14: Stroke Calibration (CAL) Screen (C4)**

**Key:**

- A Short Shot Column ICON
- B Last/Current Short Shot weight (mass) entry.
- C Long Shot Column ICON
- D Last/Current Long Shot weight (mass) entry.
- E Grams (Weight or Mass unit used)
- F Short Shot ICON
- G Long Shot ICON
- I Screen Number (C4)
- J & keys will navigate to adjacent screens.



1. Press to arm the machine to take a short CAL shots. The icon will be highlighted (). Press to de-arm the machine.
2. Place the empty container below the static mixer, and press (green) or the footswitch.
3. Press and discard the contents of the material dispensed
4. Repeat the previous 2 steps until the static mixer is filled with material. Verify the material dispensed from the mixer is mixed properly.
5. Place a container on a scale and tare (zero) it.
6. Place the tared container below the static mixer, and press (green) or the footswitch.
7. Press to erase existing average weight data.
8. Place the container with the dispensed material on the tared scale.
9. Enter the mass in grams into the HMI, by pressing or accordingly.
10. Press to accept the number. The number entered will be transferred to the right of the average icon ().
11. Repeat steps 5 through 10, skipping step 7, several times. Each additional shot weight will be averaged in the row with the previous shots.

## Priming and Calibration

12. Press  to arm the machine to take a long CAL shots. The icon will be highlighted (). Press  to de-arm the machine.
13. Place a container on a scale and tare (zero) it.
14. Place the tared container below the static mixer, and press  (green) or the footswitch.
15. Press  to erase existing average weight data.
16. Place the container with the dispensed material on the tared scale.
17. Enter the mass in grams into the HMI, by pressing  or  accordingly.
18. Press  to accept the number. The number entered will be transferred to the right of the average icon ().
19. Repeat steps 13 through 18, skipping step 15, several times. Each additional shot weight will be averaged in the  row with the previous shots.
20. Press  to de-arm the cal shot.
21. Press  twice to return to the Run screen.

## Shot Size Definition (M2)

To dispense in Shot Mode, one or more, up to 5, shot sizes need to be entered. This step is not required for Operator mode.

From the Run screen, press , then press , and then press  once. The following screen will be displayed.

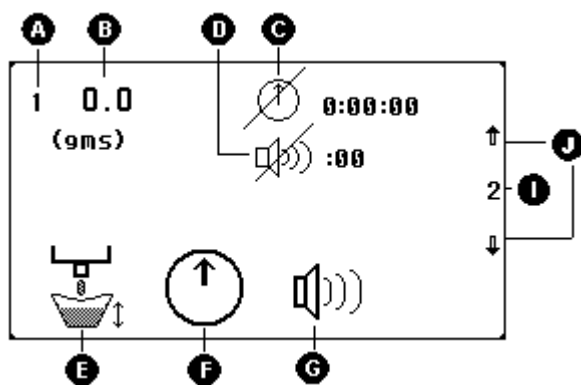



**Figure 15: Shot Size and Purge Timer Screen (M2)**

### Key:

- A Shot Number
- B Shot Size (in grams).
- C Purge Timer Setting (Turned OFF in Figure 15).
- D Purge Timer Alarm Setting.
- E Define Shot ICON
- F Set Purge Timer ICON
- G Purge Timer Warning ICON.





I Screen Number (M2).

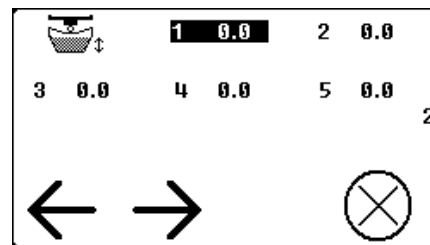



J  &  keys will navigate to adjacent screens.

1. Press . The following screen will be displayed:



**Figure 16: M2 Shot Definition Screen**





2. Press  or  to select a shot number to define.
3. Press  or  to enter the shot size.
 

 The shot size (in grams) must be greater than the Short CAL Shot size from the previous C4 calibration screen.
4. Press  to accept the value or  to retain the previous value.
5. Repeat the previous 2 steps for other shot sizes as required.
6. Press  to exit the Shot Definition screen.
7. Press  twice to return to the Run screen.

## Ratio Checks



This is a procedure to verify the weight ratio between the 2 materials. This is easiest to do with two scales.

1. From the Run screen, put the machine in Shot mode (). See page 13.
2. Verify that the machine is properly calibrated and phased as outlined in the calibration section.
3. Remove any static mixer attached to the dispense valve and replace it with a ratio check nozzle. Place a waste container under the valve to capture any dispensed material.
4. Select a shot size between the Short and Long CAL shot sizes previously done, by pressing  or  and  to accept.
5. Place the empty container below the Ratio Check Nozzle and the footswitch. Discard this shot.



## Priming and Calibration

- Place an empty container on a scale, and tare (zero) the scale. Repeat the process with a 2<sup>nd</sup> container on a 2<sup>nd</sup> scale.
- Place both containers under the ratio check nozzle, positioned so one container captures material A, and the 2<sup>nd</sup> container captures material B.
- Press the footswitch.
- After the material is dispensed, place each container on the same scale, and measure the net mass of each of the materials. Record the mass of both the A and B materials.
- Divide the A material mass by the B material mass to obtain the material ratio being dispensed.

## Miscellaneous Machine Setups

The following sections outline how to configure various optional settings.

### Manual Control Options (M1)

The user can control the machine's piston position and displacement valve operation manually the M1 screen.

From the Run Screen press  then press . The following screen will be displayed.

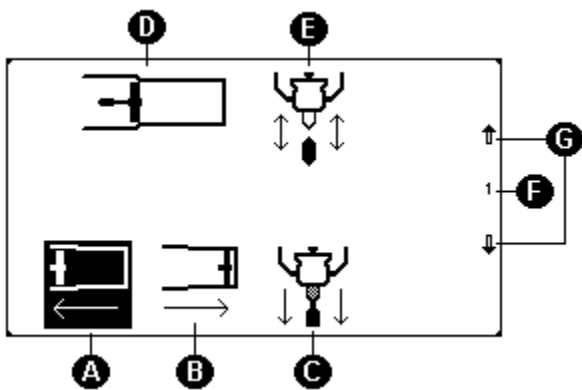









Figure 17: Maintenance Screen (M1)





#### Key:

- A Full Retract ICON
- B Full Extend ICON
- C Change Dispense Valve Mode
  -  = Always Open
  -  = Always Closed
  -  = Opens at Cylinder Entrance (Automatic)
- D Current Piston Position
- E Current Dispense Valve Mode
- F Screen Number (C1)
- G  &  keys will navigate to adjacent screens.

### Manual Piston Control:



- Press  to extend the piston.
- Press  to retract the piston.

### Manual DV Control:

- To change the DV operation press the third blue key from the left.
- When the Current Dispense Valve Mode (E in Figure 17) is , the valve will open and stay open regardless of the piston position.
- When the Current Dispense Valve Mode is , the valve will close and stay closed regardless of the piston position.
- When the Current Dispense Valve Mode is , the valve will be in automatic mode, opening when the pump gets to the cylinder entrance and closing when it gets to the end of the cylinder.
- Press  twice to return to the Run screen.

### Purge Timer / Alarm Settings (M2)

When activate, the Purge Timer will automatically dispense a shot if the machine is idle (not dispensing material) for a programmed duration of time. This prevents the mixed material from hardening in the static mixer. To set the Purge Timer;

From the Run screen, press , then press , and then press  once. The following screen will be displayed.

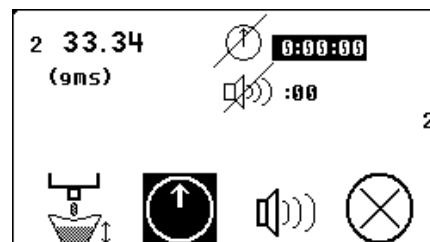



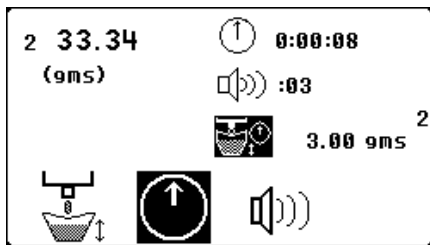

Figure 18: M2 after Purge Timer Selection

- Press .
- Press  or  to enter the purge timer value. This idle time allowed before the machine will automatically dispense a shot to clear the mixer.

- Press to accept the value or to retain the previous value.

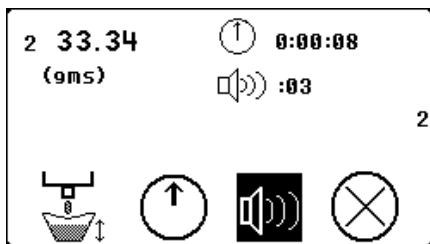

**Figure 19: M2 after Purge Shot Size Prompt**

- Press or to enter the purge shot size (in grams). Enter a number with at least as much volume as the mixer.
- Press to accept the value or to retain the previous value.
- Press twice to return to the Run screen.

Activating the purge timer automatically activates the purge alarm . This is the amount of time before the purge timer reaches zero that the machine will sound a warning beep to signaling that it is about to take a purge shot. To change the Purge Alarm value;

From the Run screen, press , then press , and then press once. The following screen will be displayed.



**Figure 20: M2 after Purge Alarm Selection**

- Press .
- Press or to enter the purge alarm duration (in seconds). The minimum value is 2 seconds, and a maximum of 59 seconds or the value of the purge timer if the timer is more than 59 seconds.
- Press to accept the value or to retain the previous value.
- Press twice to return to the Run screen.

### Cycle Counter and Silent Mode Control (M3)

#### Resetting the Cycle Counter:

The cycle counter shown on the Run screen, see Figure 6, shows the number of pump cycles since the last time the cycle counter was reset. To reset the cycle counter:

From the Run screen, press , then press , and then press 2 times. The following screen will be displayed.

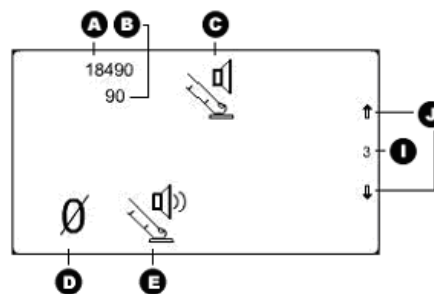

**Figure 21: M3 Cycle Counter and Silent Mode Control**

#### Key:

- A Total Pump Cycle Counter Value (Not Resettable)
- B Resettable Cycle Counter Value
- C Current Silent Mode State ICON
- Silent Mode Off
- Silent Mode On
- D Reset Cycle Counter ICON
- E Toggle Silent Mode ICON.
- I Screen Number (M3)
- J & keys will navigate to adjacent screens.

- Press .
- Press to accept the value or to retain the previous value.
- Press twice to return to the Run screen.

#### Silent Mode Operation:

The default setting is , Silent Mode Off, where audio feedback is provided when a valid key (1 short tone), or an invalid key (3 short tones) is pressed.

In , Silent Mode On, audio feedback is not provided. Silent Mode On has no effect on the audio sounds provided for the purge timer alarm, an error code, or when power is initially applied to the machine.

To toggle or change the silent mode:

From the Run screen, press , then press , and then press 2 times. Screen M3, see Figure 21, will be displayed.

- Press or .
- Press to accept the change or to retain the previous setting.
- Press twice to return to the Run screen.

## Date and Time Settings (M4)

At the bottom right corner of the Run screen the date is shown in DD-MM-YY format and the time is shown in HH:MM, 24 hour format. The formats cannot be changed.

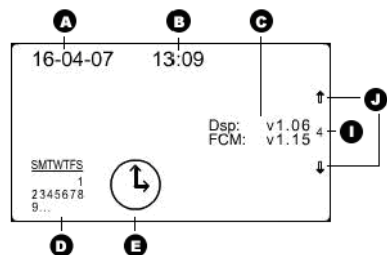

To set the current date:

From the Run screen, press , then press , and then press  3 times. The following screen will be displayed.

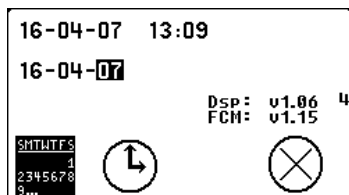

**Figure 23: M4 Screen for Setting the Date and Time**













### Key:

- A Current Date (DD-MM-YY)
- B Current Time (HH:MM, 24 Hour Format)
- C Current Software Revision  
Dsp = Display Module  
FCM = Fluid Control Module
- D Date Set ICON
- E Time Set ICON.
- I Screen Number (M4)
- J  &  keys will navigate to adjacent screens.

1. Press . The M4 screen will appear as follows.



**Figure 24: M4 Screen after Date Set Selection**









3. Press  and  to enter the year.
4. Press  to accept the change or  to retain the previous setting.
5. Press  and  to enter the month.
6. Press  to accept the change or  to retain the previous setting.
7. Press  and  to enter the day.
8. Press  to accept the change or  to retain the previous setting.
9. Press  twice to return to the Run screen.

To set the current time:



1. Press . The M4 screen will appear as follows.



**Figure 25: M4 after Time Set Selection**

2. Press  and  to enter the hour (0 - 23).
3. Press  to accept the change or  to retain the previous setting.
4. Press  and  to enter the minutes (0 - 59).
5. Press  to accept the change or  to retain the previous setting.
6. Press  twice to return to the Run screen.



## Tank Level Sensing and Velocity Change (“ΔV”) Options (C6)

If tank level sensors are installed into the system, an alarm is generated when a tank is almost empty. If the feature is turned ON, a Tank A low (“”), a Tank B low (“”), or a both tanks are low (“”) error will be generated if the condition exists.

The machine also measures the piston velocity and will generate an alarm if the piston velocity has changed significantly since the machine was last calibrated. A significant change in piston velocity, usually caused by a change in air pressure, can degrade shot size accuracy.

The user has the capability to turn the ΔV feature OFF by selecting a level of 0%, or ON by selecting ΔV levels of 20%, 40% or 60%. For instance, if 40% is selected, and the piston velocity changes by + or – 40%, an error code will be generated after the corresponding shot to inform the operator of the situation. If the velocity increases above the selected level, a ΔV+ error will be generated, and if the velocity decreases below the selected level a ΔV- error will be generated.

The ΔV feature is automatically disabled when the machine is in Operator mode, or when the machine is executing a purge shot.

From the Run screen, press , then press , then press  5 times. The following screen will be displayed.

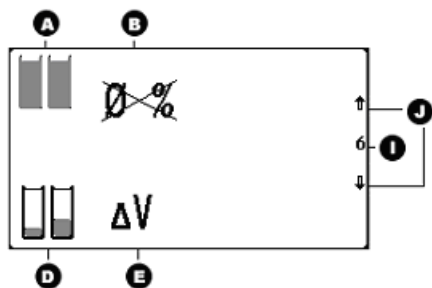

**Figure 26: Tank Level and  $\Delta V$  (C6)**

**Key:**

A Current Tank Level Mode



B Current  $\Delta V$  level

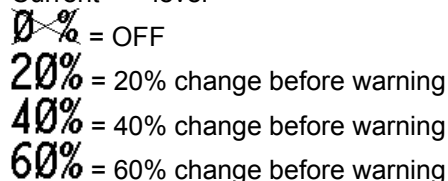

D Turn ON / OFF Tank Level Sensing ICON

E Change  $\Delta V$  Level ICON

I Screen Number (C6)

J & keys will navigate to adjacent screens.

To turn the Tank Level Sensors On/Off:

1. Press or .
2. Press to accept the change or to retain the previous setting.
3. Press twice to return to the Run screen.

To turn the Velocity Change On/Off:

1. Press  $\Delta V$ .
2. Press to accept the change or to retain the previous setting.
3. Press twice to return to the Run screen.

## Password Setup / Clearing (C5)

The machine has the capability to limit access to the Maintenance and Calibration screens. The password option can be configured into 1 of the following 3 possibilities:

- No Password** (default configuration, when machine shipped): All users can access all setup screens to configure the system.
- One password** (): Allows access to both the maintenance and calibration screens ( + ).
- Two passwords**: One password allows access to both the calibration and maintenance screen ( = + ). The second password only allows access to the maintenance screens ( = ).

To alter the password configuration:

From the Run screen, press , then press , and then press 4 times. The following screen will be displayed.

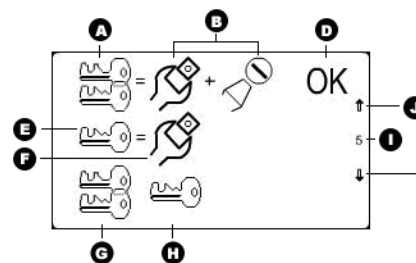

**Figure 29: C5 Screen with at least 1 Password Configured**

**Key:**

A Administrative Password ICON

B Access Indicator for Administrative Password

D Entry Status (Only filled after password change).

E Maintenance ONLY Password ICON

F Access Indicator for Maintenance ONLY Password

G Administrative Password Set/Clear ICON

H Maintenance ONLY Password Set/Clear ICON

I Screen Number (C5)

J & keys will navigate to adjacent screens.

### Setting/Clearing an Administrative Password:

1. Press . The following screen will appear.

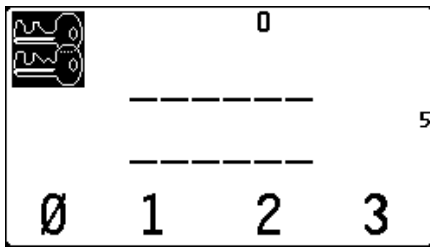

**Figure 30: Administrative Password Entry with NO Previous Password Stored**



If a previous Administrative password has been entered, the number at the top of the screen is the existing password. A zero indicates no Administrative password.

**To clear the password, enter “000000”.**

2. Enter a 6-digit sequence, by pressing the corresponding soft keys, G-J in Figure 5. After the 6th key entry, the enter LED will blink.
3. Press to accept.
4. Re-enter the same 6-digit number.
5. Press to accept.
6. If both 6-digit passwords match, the C5 screen will be displayed, and an “OK” after the first row of symbols. If the 2 numbers do not match, the process will need to be repeated.
7. Press twice to return to the Run screen.

**Setting/Clearing a Maintenance ONLY Password:**

1. Press . The following screen will appear.

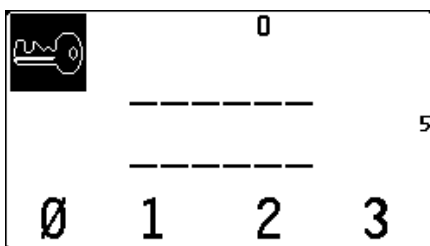

**Figure 31: Maintenance ONLY Password Entry with NO Previous Password Stored**



If a previous Maintenance Only password has been entered, the number at the top of the screen is the existing password. A zero indicates no Administrative password.

**To clear the password, enter “000000”.**

2. Enter a 6-digit sequence, by pressing the corresponding soft keys, G-J in Figure 5. After the 6th key entry, the enter LED will blink.

3. Press to accept.
4. Re-enter the same 6-digit number.
5. Press to accept.
6. If both 6-digit passwords match, the C5 screen will be displayed, and an “OK” after the second row of symbols. If the 2 numbers do not match, the process will need to be repeated.
7. Press twice to return to the Run screen.

With a Maintenance ONLY password, after the user enters the password from the Password Entry screen, the following screen will be displayed.

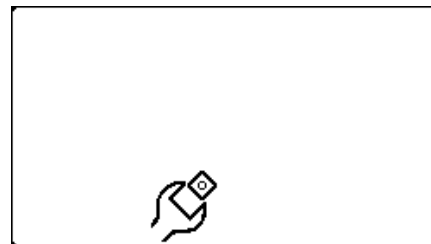

**Figure 32: Mode Selection Screen after Maintenance ONLY Password Entry**

**Resetting Passwords**

If for whatever reason, the passwords for the machine are not known, the passwords can be reset.

To reset all the passwords to 000000:

1. Temporarily remove power to the HMI.
2. Re-apply power to the HMI.
3. Immediately after the completion of the startup sequence (, , , , , ...), press and hold the second soft key for at least 6 seconds.



If the press and hold does not start immediately after the animation sequence, or the press and hold is interrupted, the procedure will need to be restarted at step 1.

4. After 6 seconds, the HMI will generate a single tone indicating that the passwords have been cleared.
5. New passwords may be entered by following the steps in Password Setup / Clearing.

## Miscellaneous Machine Features

### HMI Hibernate Mode

To help preserve the life of the HMI backlight, the HMI will enter a Hibernate mode after the machine has remained idle for an extended period of time. To exit Hibernate mode, the user simply needs to activate a HMI key or the machine footswitch.

When in Hibernate mode, the HMI LCD backlight will be turned OFF, and the enter LED will blink at a slow duty cycle (1 part ON, 8 parts OFF).

If the machine performs a purge shot when the HMI is hibernating, the HMI will remain in Hibernate mode.

### HMI Startup Animation Sequence

When power is applied to the machine, the electronics need time to initialize communication. An "Hour Glass" animation sequence is generated (⌚, ⌚, ⌚, ⌚, ⌚, ...). Attempts to use the machine during the startup period will be rejected.

### HMI Demo Mode Operation

The machine HMI is equipped with a demonstration mode. When in "Demo Mode", the HMI will not send any requests to the Fluid Control Module and the machine will not operate. The HMI will simulate normal operation and provide audio feedback to the user. All Demo Mode Maintenance and Calibration screens are identical to screens provided in normal mode operation.

Demo Mode can be used as a training tool for the user. The user simply has to connect the HMI unit to a separate power supply module, and the HMI will operate normally without the machine attached.

Any calibration, passwords, shot sizes, purge timer settings, or other miscellaneous settings entered while operating in Demo mode WILL NOT alter any normal mode settings. Also, the first time Demo mode is entered, all the calibration & maintenance screen setups previously described will need to be repeated.

To configure the HMI into and out of Demo Mode:

1. Temporarily remove power to the HMI.
2. Re-apply power to the HMI.
3. Immediately after the completion of the startup sequence (⌚, ⌚, ⌚, ⌚, ⌚, ...), press and hold the first soft key for at least 6 seconds.



If the press and hold does not start immediately after the animation sequence, or the press and hold is interrupted, the previous and this step may need to be repeated.

4. After 6 seconds, the HMI will generate a single tone and the Demo Mode ON or OFF state will be changed.
5. When in Demo Mode, a "D" will remain on the bottom left-hand corner of the Run screen, as indicated in the following figure.

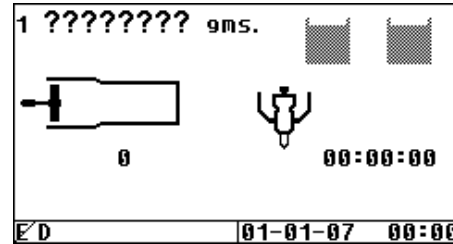

Figure 33: Typical Run Screen in Demo Mode

6. To switch the HMI out of Demo Mode, repeat the previous steps.



### Limitations of Demo Mode Simulation

Even though Demo Mode provides a good training simulation for the user, it does have limitations when compared to the HMI operating in normal mode.

- On the Run screen, all the shot mode shots are simulated as single piston stroke shots regardless of the shot size and calibration numbers entered.
- The run screen animation sequence of the piston movement is not as gradual as in real operation.
- On the Run screen, during Operator mode operation, a stalled piston condition is not simulated.
- The piston cycle counter is not stored for use after power interruption, so if power is cycled to the HMI, the cycle count will be reset.
- The piston position numbers provided on the C1 screen are simulated.
- All error codes will be NOT be generated, except a stuck key error (E11) if the condition exists.

## Pressure Relief Procedure

With the machine in an idle state:

1. If the machine pistons are not fully retracted, retract the pistons by pressing  in the M1 screen. See Figure 17.
2. Manually open the dispense valve by pressing the third M1 soft key until the “” ICON is shown in the Current DV field. See Figure 17.
3. Remove the incoming air pressure by closing the air inlet valve (item 13 in Figure 54).

## Standby/Shutdown Procedure

If the machine is to remain idle for an extended period of time, implement the following:

1. Remove any static mixer installed at the end of the dispense valve.
2. Place a container below the valve, and activate a small shot to flush material away from the end of the valve.
3. To prevent accidental pump movement, press  (red).
4. With a clean rag, clean the end of the dispense valve to remove excess material.
5. Install a nightcap at the end of the valve.

## Error Codes

When the machine is operating and a fault is detected, it will report the condition by generating an error code. Error codes are typically generated when the machine is idle after dispensing a shot.

When error codes are generated, a screen will be displayed which contains an animation sequence, the error code number and an ICON symbol representing the condition detected. The HMI will also output an error code tone sequence. The tone sequence cannot be disabled.

When errors are generated, the machine will automatically be disabled and remain in an idle state until the user acknowledges the condition. Any active purge timer present prior to error code generation will be suspended, and will need re-started by requesting a shot after the error is acknowledged.

The following typical screen is generated when an error code is generated:

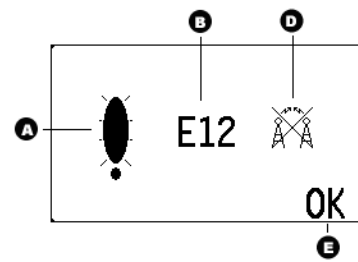

Figure 34: Typical Error Code Screen

### Key:

- A Error Code Animation Field
- B Error Code Number Field
- D Error Code ICON
- E Error Code Acknowledgement ICON

When an error code is generated, the user will need to acknowledge the condition by pressing the soft key under the **OK** ICON.

After the user activates the **OK** key, the error number generated in the Figure 34 example, will be displayed on the bottom left hand corner of the Run screen, while the condition is still present.

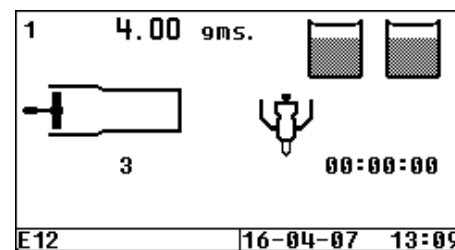









Figure 35: Typical Run Screen with an Active Error Code Condition

The example E12 number on the main run screen will remain on the run screen as long as the error condition exists. If the problem is corrected the example E12 number will be removed.



If more than 1 error code condition exists for the machine, the corresponding “EXX” numbers will be listed on the bottom left corner, separated by commas.

## Error Code Table

Title	#	Cause, Details	ICON
Stuck Key Error	<b>E11</b>	A key on membrane has been active (pressed) for > 30 seconds continuously. Replace the HMI. This error code does not require user acknowledgment and will clear itself automatically if the condition is removed.	
Communication Error	<b>E12</b>	The Display module has lost communication with the Fluid Control Module. Material dispensing will be disabled if this condition exists. Check communication cables between the 2 electronic components, or check the HMI and/or the Fluid Control Module.  This error will be regenerated continuously while the condition exists.	
No or Invalid Run Token Error	<b>E13</b>	The Run Token in the FCM is missing (not installed), or does not have the correct data.	
Piston Stroke Time-out Error	<b>E21</b>	A piston stroke action has taken > 55 seconds. Typically caused by no/too little air pressure to the machine or a mechanical interference with the piston has occurred. Check machine input line pressure.	
Less than Minimum Shot Requested Error	<b>E23</b>	User has requested a shot < the minimum allowable size entered during calibration. (< 15% of stoke, N/A in Operator Mode).	
Improper Calibration Error	<b>E24</b>	The calibration done on the machine is invalid, so the requested shot cannot be executed. For instance, a Large Stroke Calibration Shot mass which is less than the Short Stroke Calibration Shot mass (C4 screen) will create this error code. If the wiring to the linear position transducer is reversed this error will appear. If invalid piston positions are calibrated into the machine (C1 screen) this error will appear.	
Delta Velocity ("V") Minus Error	<b>E25</b>	The piston velocity is slower than the calibration velocity measured, by the percentage amount selected by the user (20%, 40% or 60%). If the user selects 0%, this monitoring or alarm feature is disabled.  If generated, shot size accuracy may be degraded. Typically the problem is created when the machine pressure regulator is adjusted to different value from when the machine was calibrated. Another less likely cause could be a mechanical failure with dispensing (worn piston, etc.). This error will not be generated for a purge shot or when the machine is in Operator mode.	$\Delta V-$
Delta Velocity ("V") Plus Error	<b>E26</b>	The piston velocity is faster than the calibration velocity measured, by the percentage amount selected by the user (20%, 40% or 60%). If the user selects 0%, this monitoring or alarm feature is disabled.  If generated, shot size accuracy may be degraded. Typically the problem is created when the machine pressure regulator is adjusted to different value from when the machine was calibrated. Another less likely cause could be a mechanical failure with dispensing (worn piston, etc.). This error will not be generated for a purge shot, or when the machine is in Operator mode.	$\Delta V+$
Low Material Level, Tank A Alarm or Error	<b>E27</b>	Tank A is low (only generated if tank sensing is enabled). Fill tank A with material.  Tank level errors will be generated after every shot if the condition still exists.	
Low Material Level, Tank B Alarm or Error	<b>E28</b>	Tank B is low (only generated if tank sensing is enabled). Fill tank B with material.  Tank level errors will be generated after every shot if the condition still exists.	



*Error Code Table*

Low Material Level, Both Tanks Alarm or Error	<b>E29</b>	Both tanks are low (only generated if tank sensing is enabled). Fill both tanks with material. Tank level errors will be generated after every shot if the condition still exists.	
Bad Linear Position Sensor	<b>E50</b>	There is a fault with the linear position sensor. Check wiring or replace.	

**Table 1: Error Code Table**





































ICON Descriptions		
Key	Key Description	Screen
	Maintenance and Calibration Screens Enter / Exit.	All
	Shot Mode / Operator Control Mode Selection.	Run
	Shot Request (green)	Run, C2, C4
	Red Stop or Cancel (Stops Operation Immediately, regardless of Screen).	All
	Up (Used to Raise Numerical Entry, Screen Navigation or Shot Selection).	Many
	Down (Used to Lower Numerical Entry, Screen Navigation or Shot Selection).	Many
	Enter (Used to Accept Entry).	Many
	Soft (Changes Function, Depending Upon Screen).	All

Table 2: PR70 HMI ICON Table

ICON	Description	Screen
	Calibration Screens.	
	Maintenance Screens.	
	Option Abort or Escape.	Many
	Piston Full Extend.	C1, M1
	Piston Full Retract.	C1, M1
	Metering Tube or Cylinder Entrance.	C1
	Phasing Shot.	C2
	Decrease Phasing Shot.	C2
	Increase Phasing Shot.	C2
	Open Displacement Valve (DV) Position Adjustment.	C3

Tables 3: PR70 Screen ICON Tables

ICON	Description	Screen
	Short Stroke Calibration Shot	C4
	Long Stroke Calibration Shot	C4
	Administrative Password Set/Clear	C5
	Maintenance Only Screens Password Set/Clear	C5
	Tank Level Sensing ON	C6
	Tank Level Sensing OFF	C6
	Delta Velocity Set Level (0 = OFF)	C6
	Displacement Valve Always Open	M1
	Displacement Valve Always Closed	M1
	Displacement Valve Automatic Operation	M1
	Shot Size Definition	M2
	Purge Timer Set/Clear	M2
	Purge Shot Size	M2
	Purge Alarm Setting	M2
	Zero Cycle Counter	M3
	Silent Mode ON	M3
	Silent Mode OFF	M3
	Set Date	M4
	Set Time	M4

Tables 4: PR70 Screen ICON Tables (Continued)

## Maintenance

The following items should be checked daily, once during a shift, or as required for the application:

- **Air Filter** - Check air filter and release any water circuit water trapped in the base of the filter.
- **Tanks** – Check material levels and refill as necessary. Verify the material reservoirs are vented properly.
- **Air Dryer** - Check the condition of the desiccant air dryer, and replace if necessary.
- **Pump Shafts** – Clean both pump shafts with solvent and lubricate with approved lubricant such as mesamoll or Silicon oil.
- **Dispense Head** – Dismantle, clean thoroughly and re-assemble. Lubricate all parts with a thin coat of approved lubricant, or silicon oil.
- **Ratio Check** – If material ratio is critical for the application, implement the ratio check procedure as required.

## Software Upgrades, Run Token

When software in the HMI or Fluid Control Module (FCM) needs updating, a black Graco update token is used.

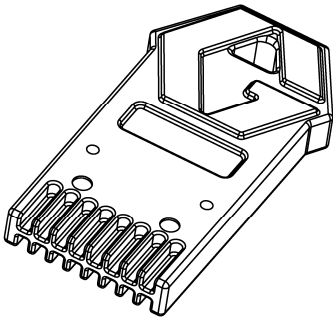

**Figure 36: Standard Graco Data Token**

To transfer an updated software program from the token to the PR70 HMI or FCM:

1. Turn OFF the AC power switch in the back of the machine.
2. If updating the Fluid Control Module (FCM), open the access door to the FCM by loosening the 2 access screws. Remove the Blue Run token from the FCM.
3. If updating the Human Machine Interface (HMI), remove the HMI from the mounting bracket and remove the back cover by removing the 4 screws on the back of the enclosure.

4. Insert a black programming token into the slot provided. Make sure it snaps into place when inserted.
5. Turn ON the AC power switch.
6. Verify the red LED on the FCM or HMI starts blinking at a fast steady rate, then the red LED stops flashing accordingly. Verify the Green LED is on continuously, and the amber LED blinks every few seconds.
7. Turn OFF the AC power switch.
8. Remove the programming token from the FCM or HMI. If the second electronic component needs updating, insert the token into the other electronic module. If the FCM was re-programmed, re-insert the blue run token in the slot provided.
9. If programming a second electronic module, repeat steps 5 through 8.
10. Re-apply machine power.
11. Go to the M4 screen to verify the new software revision(s).

## Run Token

The PR70 Fluid control module (FCM) contains a blue run token, installed in the socket provided. It has identical appearance to the black programming token, but is blue.

If the token is not installed into the FCM, the machine will not operate, and an E13 error will be generated on the display module. Hence, if the FCM software is updated, it will need to be re-installed at the end of the re-programming procedure.

## Troubleshooting



Before starting any troubleshooting procedures:

1. Relieve pressure (refer to Pressure Relief Procedure Section).
2. Disconnect AC power to the machine.

3. Allow the machine to cool, if the machine has a heat control option.

Try the recommended solutions in the order given for the each problem to avoid unnecessary repairs. Also verify all circuit breakers, switches, and controls are properly set and wiring is correct before assuming there is a problem.

PROBLEM	CAUSE	SOLUTION
HMI Display Completely Dark	No Power	Verify rear AC Power switch is ON.
	Fuse Blown	Replace Machine fuses (Refer to “Miscellaneous Mechanical Assemblies” Section).
	Loose connection	Tighten 5 pin cable on HMI.
	Bad HMI	Replace HMI
No or incorrect amount of material dispensed from either side	Ball Valve Closed	Open Tank Ball Valve (if installed).
	Tank empty	Fill tank with material
	Tank Clogged	Verify no obstruction in the tank
	Air in material	Prime the machine until the air is removed.
	Check valve malfunction	Remove, clean or replace check valve.
Piston stalled (E21 Error)	Piston worn or broken	Remove and replace piston if worn.
	Input Air Reduced or removed	Re-connect input air line to machine. Increase air pressure regulator adjustment.
	Mixer blocked	Replace static mixer. Incorporate or decrease purge time amount to prevent mixer blockage.
	ODV adjustment too late	Re-adjust the ODV setting to occur sooner (C3 screen section).
	Blocked Check valve	Remove check valve, clean and replace.
Significant material leaking from pump rear seal	Air Cylinder Failure	Remove air cylinder and re-install cylinder kit items if necessary.
	Pump Shaft worn	Remove pump shaft assembly, and re-install rear pump re-built kit.
Material dispensed not correct weight	Specific gravity of 1 or more of the 2 materials has changed since calibration.	Mix materials in tanks, dispense another shot, then re-weigh. Re-calibrate if necessary (C4 section).
	Machine Air pressure has changed since calibration.	Re-adjust air pressure regulator to value used when machine was calibrated, or re-calibrate (C4 section). Turn ON or decrease $\Delta V$ % level.
	Not enough material in 1 or more tanks	Check tank levels, and fill and prime if necessary.
	Mixer has slight obstruction	Replace static mixer. Re-prime machine.
	Check valve malfunction	Remove check valve(s), clean or replace if necessary.
Machine dispensing off ratio	Piston worn or broken	Remove and replace piston(s) if necessary.
	One tank is empty	Check tank levels. Add material if necessary.
	Tank Ball valve Closed	Open tank ball valve. Re-prime machine.
	Machine out of phase	Re-phase machine (C2 section).
	Check valve malfunction	Remove check valve(s), clean or replace if necessary.
Pumps drawing material back from valve hose	Piston worn or broken	Remove and replace piston(s) if necessary.
	Check valve stuck open	Remove check valve(s), clean or replace if necessary.

# Repair

## Major Mechanical Assemblies, and Attachments

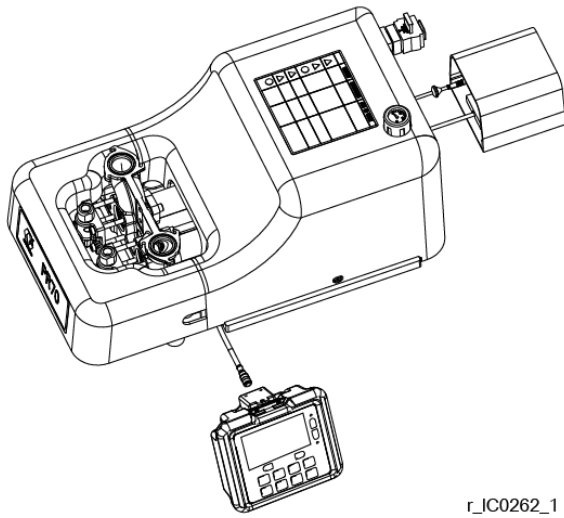

r\_IC0262\_1

**Figure 38: PR70 Top View w/o Tanks with Footswitch and HMI Illustrated**

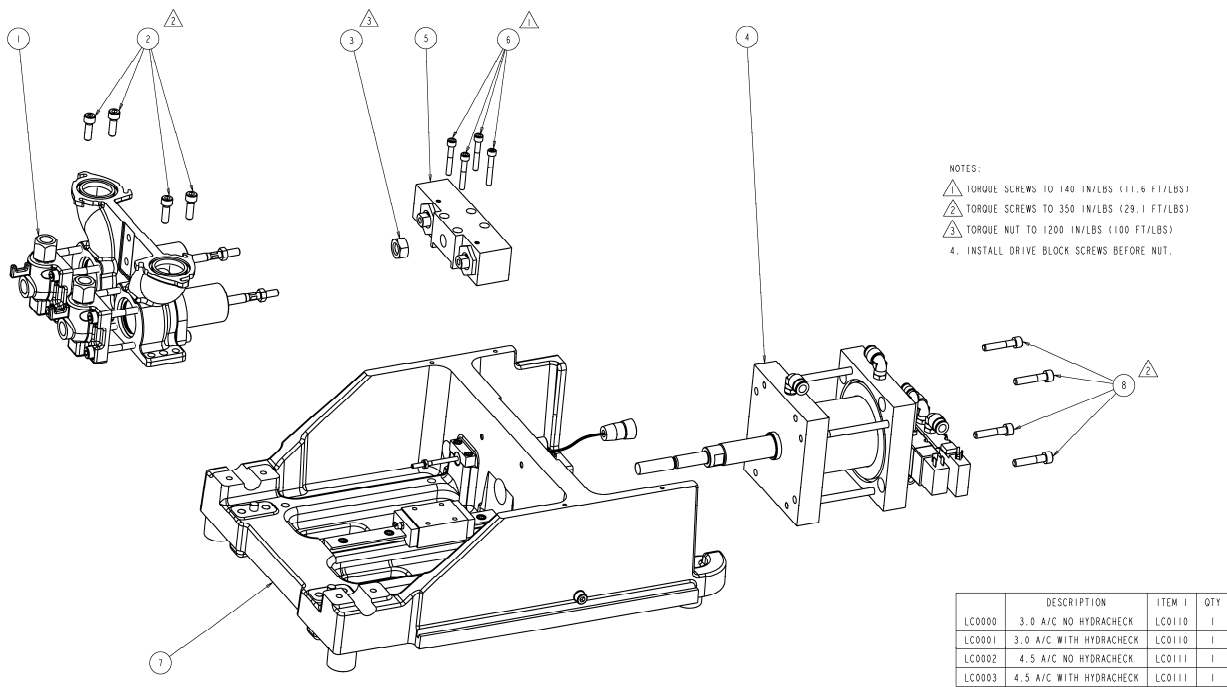

NOTES:  
 ▲ TORQUE SCREWS TO 140 IN/LBS (11.6 FT/LBS)  
 ▲ TORQUE SCREWS TO 350 IN/LBS (29.1 FT/LBS)  
 ▲ TORQUE NUT TO 1200 IN/LBS (100 FT/LBS)  
 4. INSTALL DRIVE BLOCK SCREWS BEFORE NUT.

	DESCRIPTION	ITEM #	QTY
LC0000	3.0 A/C NO HYDRACHECK	LC0110	1
LC0001	3.0 A/C WITH HYDRACHECK	LC0110	1
LC0002	4.5 A/C NO HYDRACHECK	LC0111	1
LC0003	4.5 A/C WITH HYDRACHECK	LC0111	1

**Figure 39: PR70 Base Frame to Air Cylinder, Pump and Drive Block Attachments**

**Key:**

Ref	P/N	Description	QTY	Ref	P/N	Description	QTY
1	LC0112	Pump Assembly, PR70	1	5	LC0107	Drive Block Assembly, PR70	1
2	120913	Screw, SHC, M8-1.25 x 25	4	6	121166	Screw, SHC, M6-1.0 x 40	4
3	120919	Nut, Hex, M14	1	7	LC0109	Base Frame Assembly	1
4	LC0110, or LC0111	Air Cylinder Assemblies, 3.0" or 4.5"	1	8	121167	Screw, SHC, M8 - 1.25 x 40	4

## Base Frame and Air Cylinder Assemblies

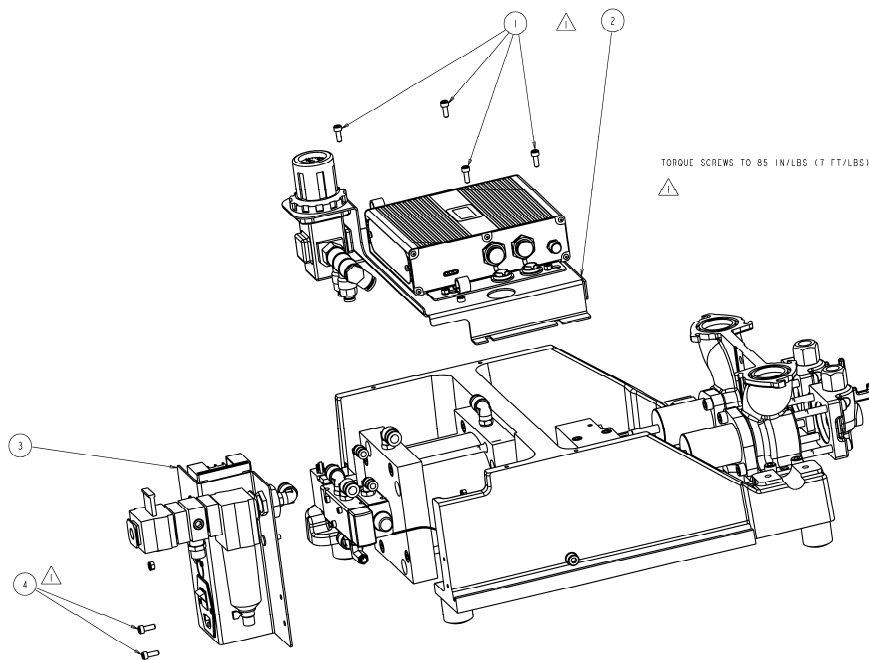
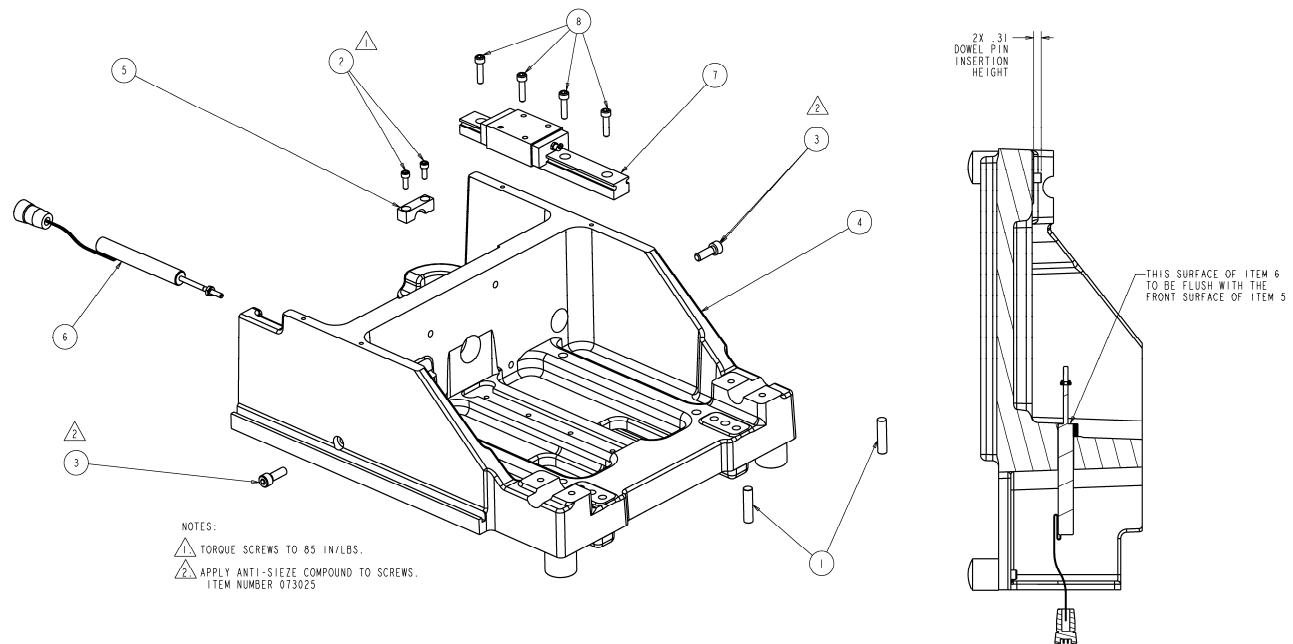

**Figure 40: PR70 Power Entry Bracket and Control Bracket Assembly Attachments**

### Key:

Ref	P/N	Description	QTY	Ref	P/N	Description	QTY
1	120885	Screw, SHC, M5 – 0.8 x 14	4	3	LC0106	Power Entry Assembly, PR70	1
2	LC0108	Control Bracket Assembly, PR70	1	4	120885	Screw, SHC, M5 – 0.8 x 14	2

## Base Frame Assembly

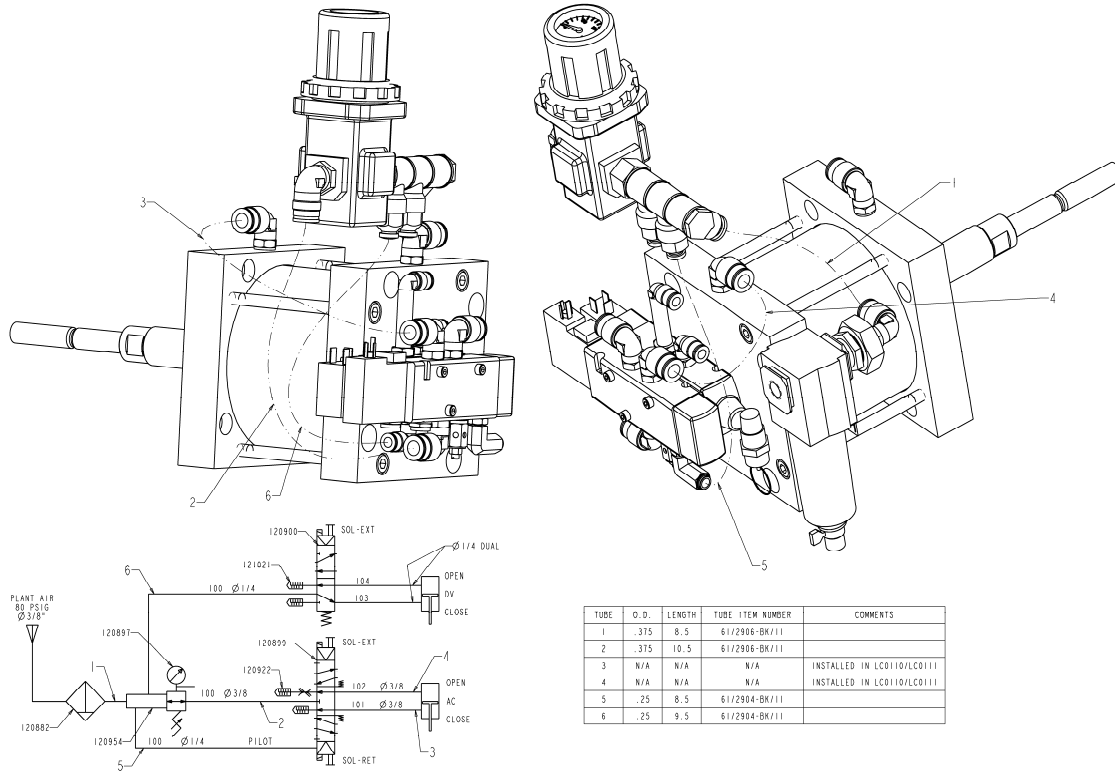

**Figure 41: PR70 Base Frame Assembly (LC0109)**

### Key:

Ref	P/N	Description	QTY	Ref	P/N	Description	QTY
1	120599	PIN, DOWEL, 3/8DIAX1.50LG, SS	2	5	15K796	CLAMP	1
2	120885	SCREW,SHC, M5-0.8X14,MS,E	2	6	LC0033	TRANSDUCER ASSY, LINEAR, PR70S	1
3	120913	SCREW,SHC, M8X1.25X25,MS, E	2	7	120918	GUIDE, LINEAR	1
4	15K788	FRAME, BASE, PR70S, MACHINED	1	8	120886	SCREW, SHC,M6-1.0X25,MS,E	4

Base Frame and Air Cylinder Assemblies  
**Air Cylinder Assemblies, and Rebuild Kits**



**Figure 42: PR70 Air Cylinder System and Schematic**



## Air Cylinder Assemblies

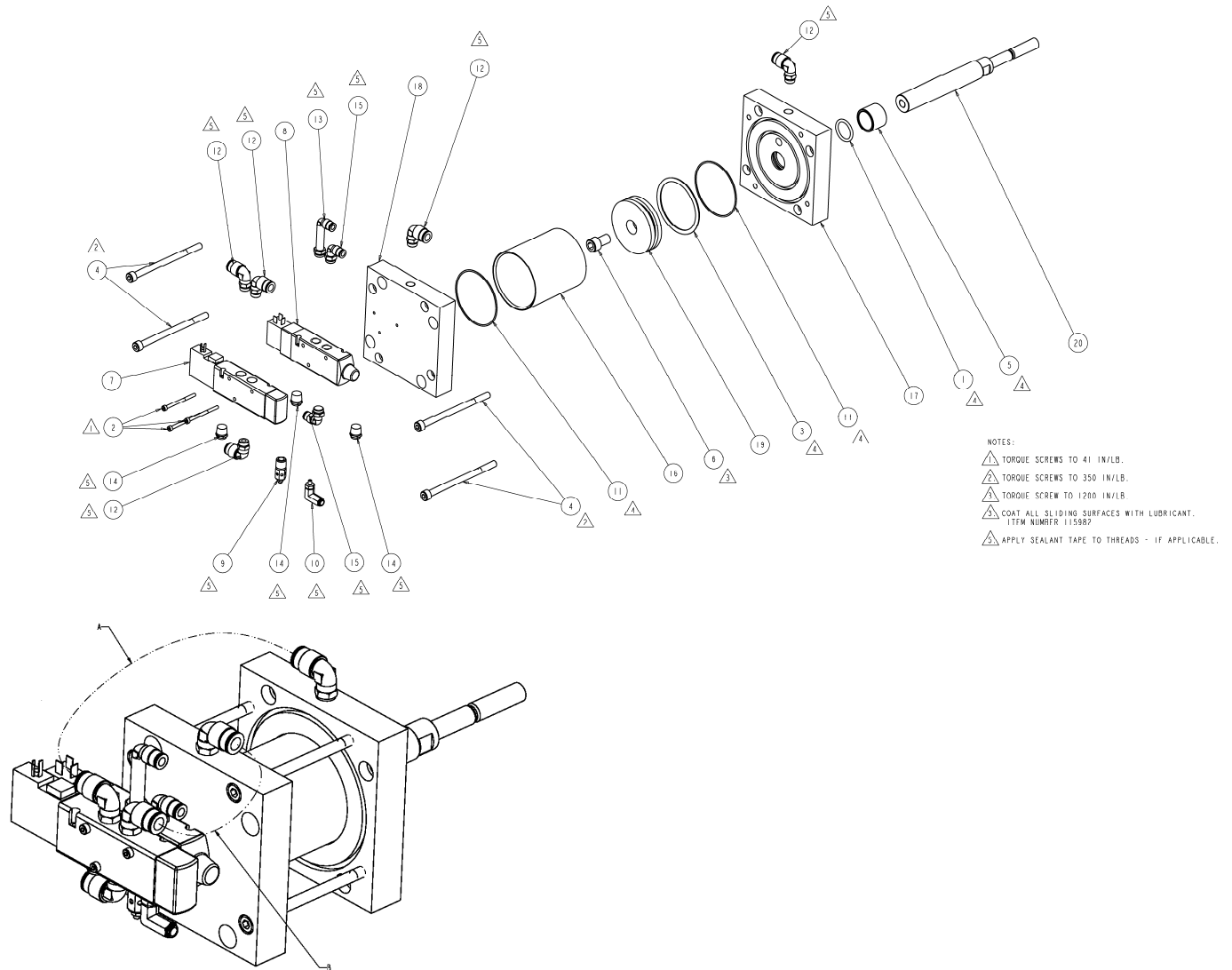

**Figure 43: PR70 Air Cylinder Assemblies, 3.0" & 4.5" Diameters (LC0110 & LC0111)**

### Key:

#### (LC0110, 3.0" DIA. Assy., PR70)

Ref	P/N	Description	QTY
1	107571	ORING, VIT, BAD	1
2	114100	SCREW, SHC, M4X0.7X55, MS, E	3
3	120875	ORING, VIT, CCE	1
4	120880	SCREW, SHC, M8-1.25 X 125, MS, E	4
5	120881	BEARING, 1.00ID X 1.252 OD X 1.00LG,	1
6	120884	SCREW, SHC, M12-1.75 X 20, MS	1
7	120899	VALVE, 4W, 3P, COE, DSSC, 1/4 NPT, 24VDC	1
8	120900	VALVE, PWR, 4W, SSSR, 1/4NPT, 24VDC	1
9	120922	MUFFLER, AIR, 1/4 NPT, FLOW CONTROL	1
10	120923	ELBOW, SWVL, 1/4 TUBE X 10-32, FXM, 90°,	1
11	120932	ORING, VIT, JDA	2
12	121018	ELBOW, SWVL, 3/8 TUBE X 1/4 NPT, FXM, 90°	5
13	121020	ELBOW, SWVL, EXT'D, 1/4 X 1/4 NPT, FXM, 90°	1
14	121021	MUFFLER, AIR, 1/4 NPT, BRONZE	3
15	121022	ELBOW, SWVL, 1/4 TUBE X 1/4 NPT, FXM, 90°	2
16	15K790	TUBE, AIR CYL, 3.0 I.D., PR70S	1
17	15K791	BLOCK, AIR CYL, ROD END, PR70S	1
18	15K792	BLOCK, AIR CYL, BLIND END, PR70S	1
19	15K793	PISTON, AIR CYL, 3.0 I.D., PR70S	1
20	15K795	ROD, PISTON, AIR CYL, PR70S	1

#### (LC0111, 4.5" DIA. Assy., PR70)

Ref	P/N	Description	QTY
1	107571	ORING,VIT,BAD	1
2	114100	SCREW, SHC, M4X0.7X55,MS,E	3
3	104131	ORING,VIT,CDG	1
4	120880	SCREW,SHC,M8-1.25X125,MS,E	4
5	120881	BEARING, 1.00IDX1.252ODX 1.00LG	1
6	120884	SCREW, SHC, M12-1.75X20,MS	1
7	120899	VALVE, 4W, 3P,COE, DSSC, 1/4NPT, 24VDC	1
8	120900	VALVE,PWR,4W, SSSR, 1/4 NPT, 24VDC	1
9	120922	MUFFLER,AIR, 1/4NPT, FLOW CONTROL	1
10	120923	ELBOW, SWVL, 1/4 X 10-32, FXM, 90°, CM/PL	1
11	104271	ORING,VIT,JDG	2
12	121018	ELBOW,SWVL,3/8TUBEX 1/4 NPT, FXM, 90DE	5
13	121020	ELBOW, SWVL, EXT'D, 1/4 X 1/4 NPT, FXM, 90°	1
14	121021	MUFFLER,AIR, 1/4 NPT, BRONZE	3
15	121022	ELBOW, SWVL, 1/4 TUBE X 1/4 NPT, FXM, 90DE	2
16	15K789	TUBE, AIR CYL,4.5 I.D.,PR70S	1
17	15K791	BLOCK, AIR CYL, ROD END, PR70S	1
18	15K792	BLOCK, AIR CYL, BLIND END, PR70S	1
19	15K794	PISTON, AIR CYL,4.5 I.D.,PR70S	1
20	15K795	ROD, PISTON, AIR CYL,PR70S	1

## Pump Assembly

### To install a new Air Cylinder Kit:

- Follow the Pressure Relief Procedure and turn off the machine.
- Disconnect the airline, remove the PR70 Shroud, and remove the machine power entry assembly (item 3 of Figure 40) from the machine by removing the 2 attachment screws (4 of Figure 40).
- Remove the 2 air valves (items 7 & 8) from the cylinder end block (18) by removing the 3 attachment screws (2).
- Disconnect the air cylinder piston rod (20) from the machine drive block assembly (item 5 of Figure 39) by removing all hex nuts (item 3 of Figure 39) from the piston rod (additional nuts may be installed if the machine has a Hydracheck option). An open-end wrench will be required to prevent the rod from turning when the nuts are removed.
- Disconnect the air cylinder from the machine frame base assembly (item 7 of Figure 39) by removing the 4 screws (item 8 of figure 39), which attach the cylinder rod end block (17) to the frame. Access the screw through the 4 holes in the blind end block (18) using a long allen wrench.
- Remove the air cylinder by pulling on the cylinder from the back of the machine.
- With the cylinder partially removed, disconnect the airlines at the air cylinder elbow fittings (12).
- On a bench, disassemble the air cylinder by removing the 4 long screws (4), which connect the 2 cylinder blocks.
- Inspect the cylinder tube (16) and piston (19) to verify no scratches exists. Replace if necessary.
- Using a clean dry cloth, remove any existing grease from the inside of the tube (16), the outside of the piston (19) and the cylinder rod (20).
- Remove the 2 cylinder block o-rings (item 2 of Figure 40) from the blocks and replace. Remove the piston o-ring and replace (item 1 of Figure 40).
- Remove the cylinder rod from the rod end block, then remove the rod o-ring (item 3 of Figure 40) from the rod end block and replace.
- Liberaly apply Graco high temperature lubricant Grease (Graco P/N 115982) to the inside of the tube (16), the outside of the piston (19), all the o-rings and the cylinder rod (20).
- Re-assemble the air cylinder. Attach the 2 drive blocks by reinstalling the 4 long screws (4) finger tight. Then torque the screws as specified in note  $\triangle 2$  of Figure 43 in a crisscross pattern.

#### NOTICE

In the previous step, air cylinder damage may result if screws are not installed in a crisscross pattern.

- Air Cylinder damage may result if bolts are not installed in a crisscross pattern.
- Reinsert the air cylinder into the back of the machine by inserting the cylinder rod through the hole in the base frame and in the drive block.
- Before the cylinder is completely in place, re-connect the airlines to the cylinder block elbows fittings (12). Verify the correct airlines are connected (see Figure 43).
- Reattach the cylinder to the base frame by reinstalling the 4 screws (item 8 of Figure 39).
- Reattach the cylinder to the drive block by reinstalling the hex nut (item 3 of Figure 39) to the cylinder rod. Torque the nut as specified in note  $\triangle 3$  of Figure 39.
- Reattach the valves to the blind end block by reattaching the 3 screws (2).
- Reattach the power entry assembly by reinstalling the 2 attachment screws (item 4 of Figure 40).
- Reconnect input air into the machine. Operate the machine accordingly, and verify no air leaks are found. Recalibrate the machine.

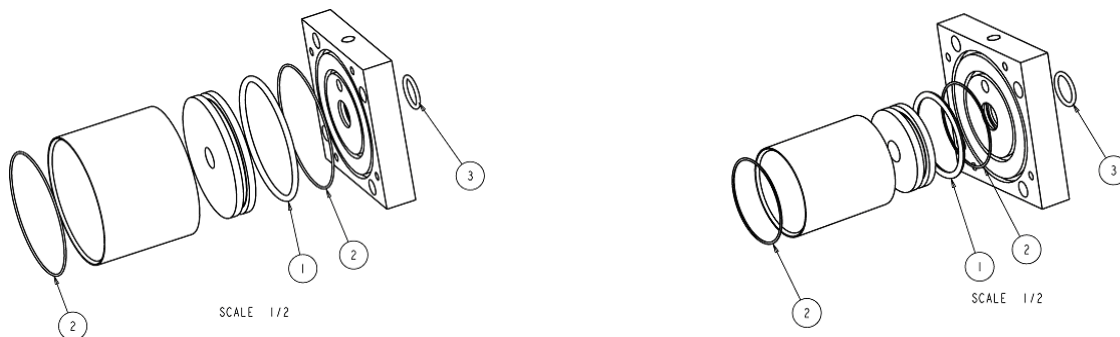

Figure 44: PR70 Air Cylinder Rebuild Kits, 4.5" and 3.0" Diameter Versions (LC0092 & LC0091).

### Key:

#### (LC0092, 4.5" DIA. Rebuild Kit)

Ref	P/N	Description	QTY
1	104131	ORING, VIT, CDG	1
2	104271	ORING, VIT, JDG	2
3	107571	ORING, VIT, BAD	1

#### (LC0091, 3.0" DIA. Rebuild Kit)

Ref	P/N	Description	QTY
1	120875	ORING, VIT, CCE	1
2	120932	ORING, VIT, JDA	2
3	107571	ORING, VIT, BAD	1

Pump Assembly

**Drive Block Assembly**

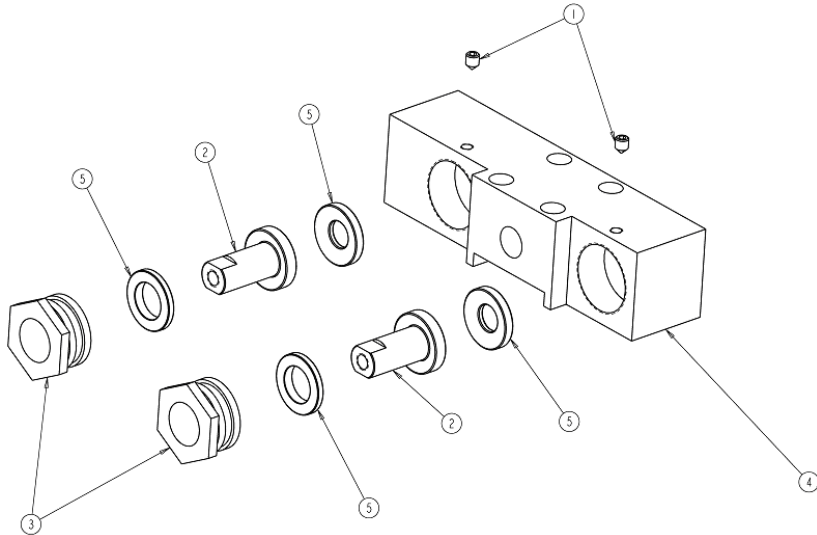
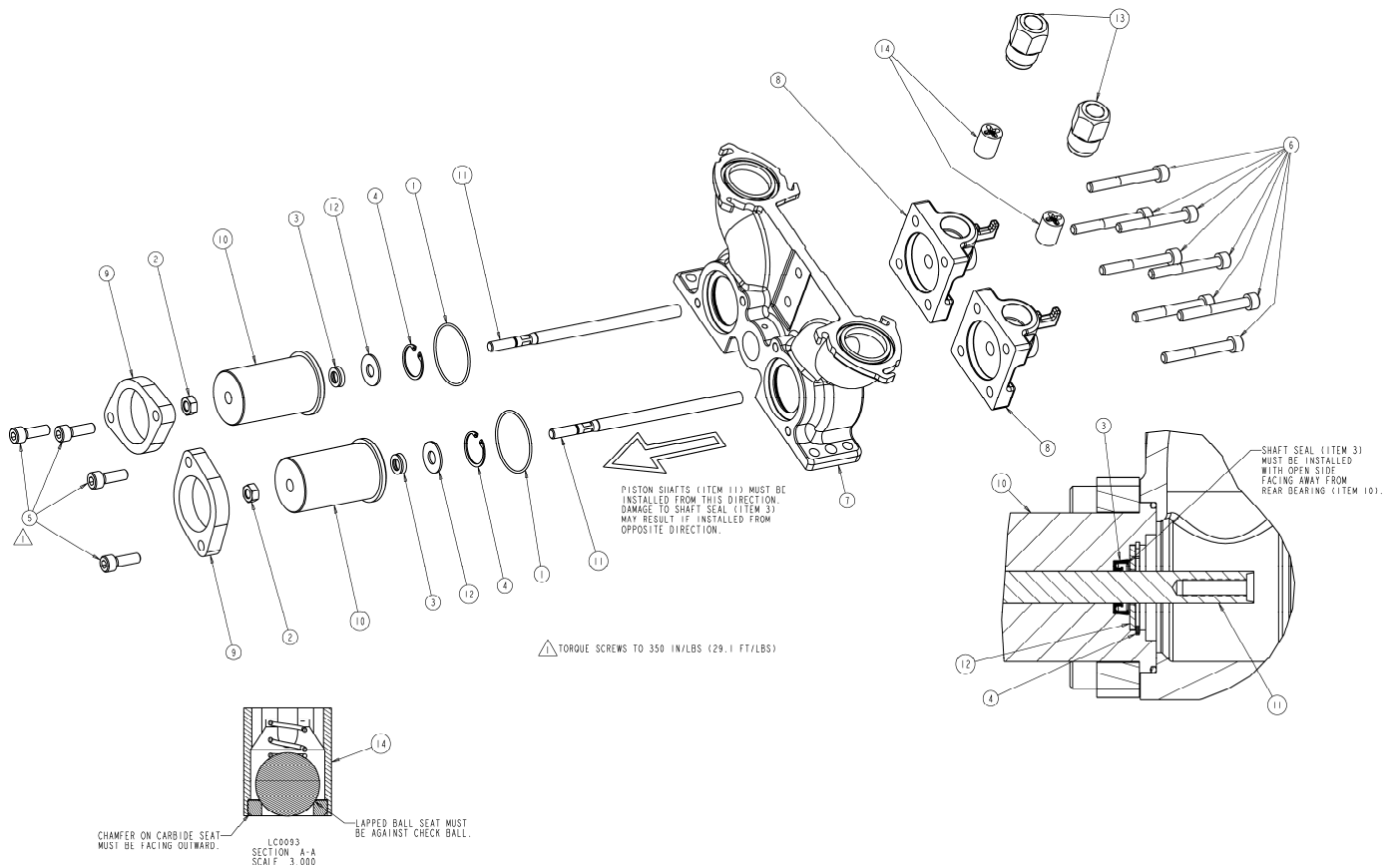

**Figure 45: PR70 Drive Block Assembly (LC0107)**

**Key:**

Ref	P/N	Description	QTY	Ref	P/N	Description	QTY
1	120891	SCREW, SHS, M6-1.0 X 8, MS	2	4	15K805	BLOCK, DRIVE, PR70S	1
2	15K801	ROD, ALIGNMENT	2	5	15K868	WASHER, SPERICAL, 1/2 DIA. MODIFIED	2
3	15K802	NUT, RETAINER	2	6	84/0130-27/11	LABEL, HAND CRUSH, 1.3 X 1.1, TRIANGLE, ISO	1

**Pump Assemblies and Rebuild Kits**





**Figure 46: PR70 Pump Assembly (LC0112)**

## Pump Assembly

### Key:

Ref	P/N	Description	QTY	Ref	P/N	Description	QTY
1	106258	ORING, VIT, JCB	2	9	15K803	COLLAR, PUMP	2
2	108712	NUT, HEX, M8 X 1.25, MS	2	10	15K804	HOUSING, BEARING, SEAL, PR70S	2
3	120887	POSIPAK, 0.375ID X 0.625OD, COIL	2	11	15K824	SHAFT, PISTON, 3/8, PR70S, SS	2
4	120890	RING, RET, INT, 1.00, SS	2	12	15K828	WASHER, SEAL, 3/8, PR70S, SS	2
6	120982	SCREW, SHC, M8 X 1.25 X 65, MS, E	8	13	15K895	HOUSING, CHECK VALVE	2
7	15K786	HOUSING, PUMP, PR70S, MACHINED	1	14	LC0093	KIT, REBUILD, VALVE, CHECK, PR70S	2
8	15K787	CAP, END, PUMP, PR70S, MACHINED	2				

### To install a new Check Valve Rebuild Kit:

- With the machine in an idle state and a bucket below the dispense valve to catch material, fully extend the piston by pressing  in the M1 screen.
- To prevent machine movement, press  (red).
- With a bucket below the check valve to be replaced, disconnect the male hose fitting from the check valve housing (13), by loosening the hose from the housing. Catch any material draining from the hose into the bucket.
- Remove the check valve housing (13) from the pump endcap (8) by loosening the housing with a wrench.
- Remove the existing check valve (14) from the housing (13) by inserting a screwdriver or dowel rod into the female threaded end of the check valve housing.
- With the new check valve ball guide (item #3 in figure 43) on a bench with the open end up, install the check valve spring (item 2 of figure 47) into the guide.
- Install the check valve ball (item 1 of figure 47) on top of the spring.
- With the rounded inside surface of the check valve seat (item 4 of figure 47) facing down, place the seat on top of the check valve ball.
- Holding both ends of the assembled check valve assembly, install the check valve into the un-threaded end of the check housing (13) with the ball end facing out. Apply some pressure to the valve to snugly fit the completed check valve into the housing and then fit the check valve seat (item 4 of figure 47) into the valve guide.
- Verify when the assembled check valve and housing (13) are turned up-side down, that the contents of the valve stays in place.
- Re-insert the new valve and valve housing into the pump end cap, using a wrench.
- Re-install the material male hose fitting into the check valve housing using a wrench.
- Before re-using the machine for operation, activate a few shots to purge any air present in the material hose lines due to the procedure.
- Re-calibrate the machine if necessary.

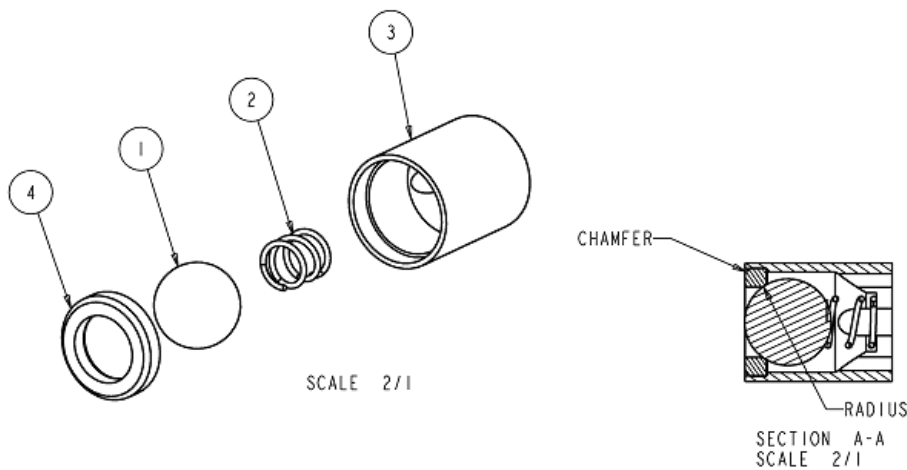
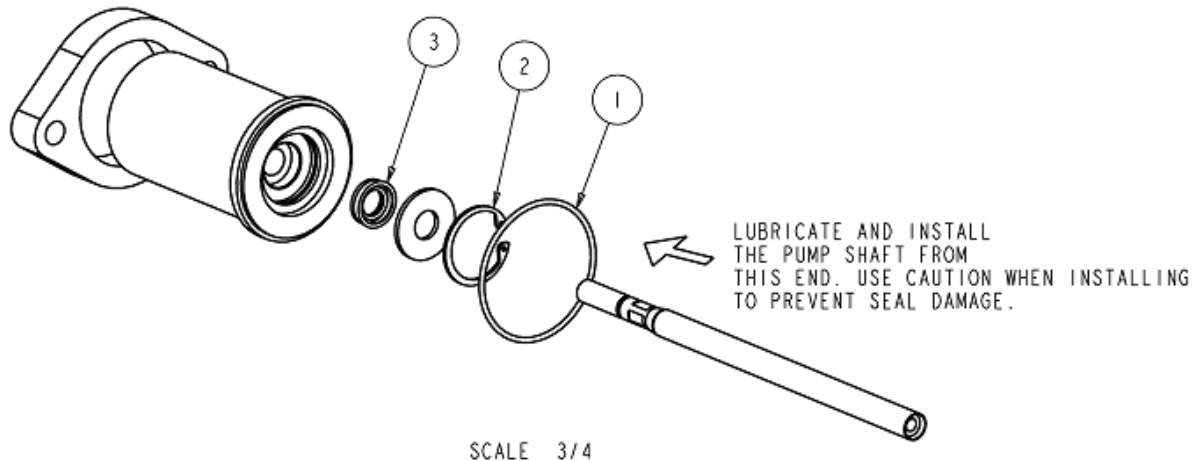

Figure 47: PR70 Check Valve Rebuild Kit (LC0093)

### Key:

Ref	P/N	Description	QTY	Ref	P/N	Description	QTY
1	105445	BALL,CHECK VALVE	1	3	15D312	BUSHING, BALL GUIDE	1
2	121084	SPRING, 0.300D X 0.44LG, 22#/IN, 20PSI, S	1	4	196832	SEAT, LAPPED, CHECK VALVE	1

## Pump Assembly



**Figure 48: PR70 Rear Pump Rebuild Kit (LC0094)**

### Key:

Ref	P/N	Description	QTY	Ref	P/N	Description	QTY
1	106258	ORING, VIT, JCB	1	3	120887	POSIPAK, 0.375ID X 0.625OD, COIL	1
2	120890	RING, RET, INT, 1.00, SS	1				

### To install a new Rear Pump Rebuild Kit:

1. Drain the pump by taking several shots with either the tank ball valves closed (if installed), or by activating enough shots to empty the tanks.
2. Disconnect the pump shaft (item 11 of Figure 46) from the drive block assembly by loosening the shaft locking nut (item 2 of Figure 46), then turning the shaft with a wrench while preventing the drive block alignment rod (item 2 of Figure 45) from rotating with a wrench. Manually push the pump shaft forward toward the extend position to separate the shaft from the drive block.
3. Remove the shaft lock nut from the shaft.
4. Remove the pump collar (item 9 on Figure 46) from the pump housing (item 7 on Figure 46) by removing the 2 screws (item 5 on Figure 46).
5. Slide the pump bearing housing (item 10 of Figure 46) away from the pump housing to remove.
6. Remove the existing rear pump build components (refer to Figure 48 items) from the pump bearing housing.
7. Using a clean dry cloth, remove any existing grease from the bearing housing.
8. Apply new high temperature grease lubricant (Graco P/N 115982) to the inside of the pump bearing housing, and the new rebuild components.
9. Install the new rebuild kit components into the bearing housing as indicated in Figure 48.
10. Apply 1 layer of thin masking tape over the male threads of the pump shaft, which mates with the drive block. This will prevent the threads from damaging the seal or Posipak (3).
11. Using extreme caution, slide the pump shaft through the hole in the bearing housing as indicated in Figure 48. Align the bearing housing in position next to the pump housing.
12. Re-install the pump collar over the bearing housing and attach it to the pump housing using the 2 screws (item 5 on Figure 46) previously removed.  
Torque the screws as specified in note  of Figure 46.
13. Remove the masking tape from pump shaft.
14. Re-install the pump shaft lock nut to the pump shaft.
15. Re-install the pump shaft to the drive block alignment rod.
16. Re-tighten the lock nut.
17. Open the tank ball valves (if installed) and put more material into the tanks.
18. Instigate several shot to fill the pump with new material.
19. Re-calibrate and re-phase the machine, due to the procedure performed.

**Piston Cylinders or Metering Tubes**

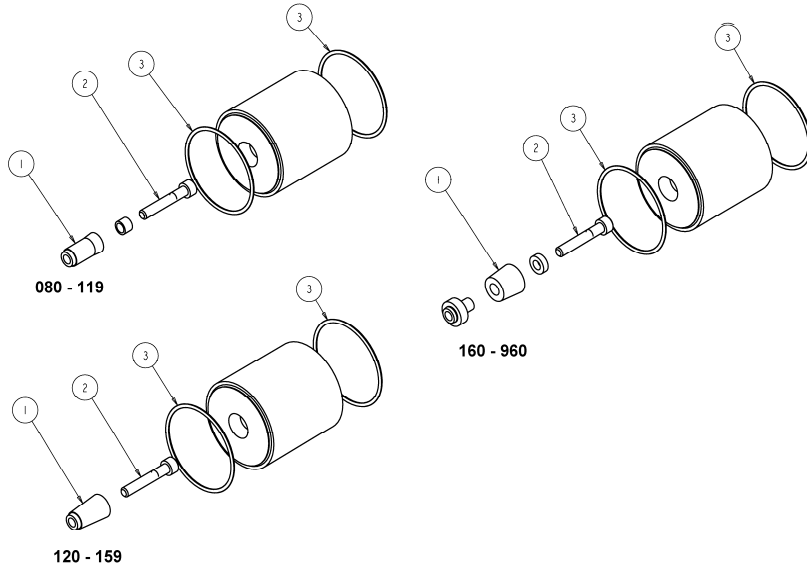

**Figure 49 PR70 Nylon and UHMWPE Piston Replacement Kits**

**Key:**

Ref	Description	QTY	Ref	Description	QTY
1	Piston	1	3	O-ring	2
2	Screw	1			

When ordering a piston replacement kit, the following intelligent part numbering system applies for Nylon based pistons:

**LCF - 120**

Code :      A  
 Piston Size (mm<sup>2</sup>)

The items indicated in Figure 49 above will be supplied with the kit. Refer to the Models section for the available standard piston sizes.





When ordering a UHMWPE replacement kit, the following numbering applies:

**LCE - 160**

Code :      A  
 Piston Size (mm<sup>2</sup>)

Pistons & Metering Tubes

**To install a new Piston or Piston/Cylinder Replacement Kit:**

1. Drain the machine pistons by instigating several shots with either the tank ball valves closed (if
3. Remove the pump end caps (item 8 of figure 46) by removing the 4 end cap screws (item 6 of figure 46). Allow the cap to hang by the hose.
4. Remove the cylinder and Orings (items 1 and 6 of figure 50) from the pump housing (item 7 of figure 46) and pump cap.
5. Select an operating mode, then fully extend the pistons by activating the  option in the M1 screen.
6. To prevent machine movement, press  (red).
7. Remove the existing piston (1) and any front or rear washers (items 3 & 4 of figure 50) from the pump shaft (item 11 of figure 46) by removing the piston screw (2). A wrench will be required near the drive block to prevent the pump shaft from rotating while the screw is removed.
8. Install the new piston and any rear or front washers, by re-installing the piston screw into the pump shaft. When tightening the piston screw, tighten the screw until the piston stops rotating, then turn the screw an additional 1/4 turn.
2. To prevent machine movement, press  (red).
9. Select an operating mode, then retract the pistons by pressing  in the M1 screen.
10. To prevent machine movement, press  (red).
11. Lubricate the new o-rings with a high temperature grease, Graco P/N 115982 or equivalent. Place the lubricated o-rings into the inside circle placements in the pump housing and pump end caps.
12. Install the cylinder between the pump housing and end cap, then secure the cylinder and Orings by re-attaching the 4 end cap screws (item 6 of figure 46).
13. Open the tank ball valves (if installed) or put more material into the tanks.
14. Instigate several shot to fill the pump with new material.
15. Re-calibrate the machine, due to the procedure performed.

NYLON PISTONS (SEE FIGURE 50)									
Part No.	Rev.	Series	Area	Tube Item 1	Piston Item 2	Fr. Washer Item 3	Back Washer Item 4	Screw Item 5	O-ring Item 6
LC1080	A	A	80	LCC080	LCB080	15M089	NOT REQ	120933	120874
LC1100	A	A	100	LCC100	LCB 100	15M089	NOT REQ		
LC1120	A	A	120	LCC120	LCB 120	NOT REQ	NOT REQ		
LC1140	A	A	140	LCC 140	LCB 140	NOT REQ	NOT REQ		
LC1160	A	A	160	LCC 160	LCB 160	15M099	15K887		
LC1180	A	A	180	LCC 180	LCB 180	15M099	15K887		
LC1200	A	A	200	LCC 200	LCB 200	15M099	15K887		
LC1220	A	A	220	LCC 220	LCB 220	15M099	15K887		
LC1240	A	A	240	LCC 240	LCB 240	15M100	15K887		
LC1260	A	A	260	LCC 260	LCB 260	15M100	15K887		
LC1280	A	A	280	LCC 280	LCB 280	15M100	15K887		
LC1300	A	A	300	LCC 300	LCB 300	15M100	15K887		
LC1320	A	A	320	LCC 320	LCB 320	15M100	15K888		
LC1360	A	A	360	LCC 360	LCB 360	15M100	15K888		
LC1400	A	A	400	LCC 400	LCB 400	15M100	15K888		
LC1440	A	A	440	LCC 440	LCB 440	15M100	15K888		
LC1480	A	A	480	LCC 480	LCB 480	15M100	15K888		
LC1520	A	A	520	LCC 520	LCB 520	15M100	15K888		
LC1560	A	A	560	LCC 560	LCB 560	15M101	15K888		
LC1600	A	A	600	LCC 600	LCB 600	15M101	15K888		
LC1640	A	A	640	LCC 640	LCB 640	15M101	15K890		
LC1720	A	A	720	LCC 720	LCB 720	15M101	15K890		
LC1800	A	A	800	LCC 800	LCB 800	15M101	15K890		
LC1880	A	A	880	LCC 880	LCB 880	15M101	15K890		
LC1960	A	A	960	LCC 960	LCB 960	15M101	15K890		

NYLON PISTONS (SEE FIGURE 50)									
Part No.	Rev.	Series	Area	Tube Item 1	Piston Item 2	Fr. Washer Item 3	Back Washer Item 4	Screw Item 5	O-ring Item 6
LC2160	A	A	160	LCA160	LCB160	15M099	15K887	120933	120874
LC2180	A	A	180	LCA180	LCB 180	15M099	15K887		
LC2200	A	A	200	LCA200	LCB 200	15M099	15K887		
LC2220	A	A	220	LCA220	LCB 220	15M099	15K887		
LC2240	A	A	240	LCA240	LCB 240	15M100	15K887		
LC2260	A	A	260	LCA260	LCB 260	15M100	15K887		
LC2280	A	A	280	LCA280	LCB 280	15M100	15K887		
LC2300	A	A	300	LCA300	LCB 300	15M100	15K887		
LC2320	A	A	320	LCA320	LCB 320	15M100	15K888		
LC2360	A	A	360	LCA360	LCB360	15M100	15K888		
LC2400	A	A	400	LCA400	LCB400	15M100	15K888		
LC2440	A	A	440	LCA440	LCB440	15M100	15K888		
LC2480	A	A	480	LCA480	LCB480	15M100	15K888		
LC2520	A	A	520	LCA520	LCB520	15M100	15K888		
LC2560	A	A	560	LCA560	LCB560	15M101	15K888		
LC2600	A	A	600	LCA600	LCB600	15M101	15K888		
LC2640	A	A	640	LCA640	LCB640	15M101	15K890		
LC2720	A	A	720	LCA720	LCB720	15M101	15K890		
LC2800	A	A	800	LCA800	LCB800	15M101	15K890		
LC2880	A	A	880	LCA880	LCB880	15M101	15K890		
LC2960	A	A	960	LCA960	LCB960	15M101	15K890		

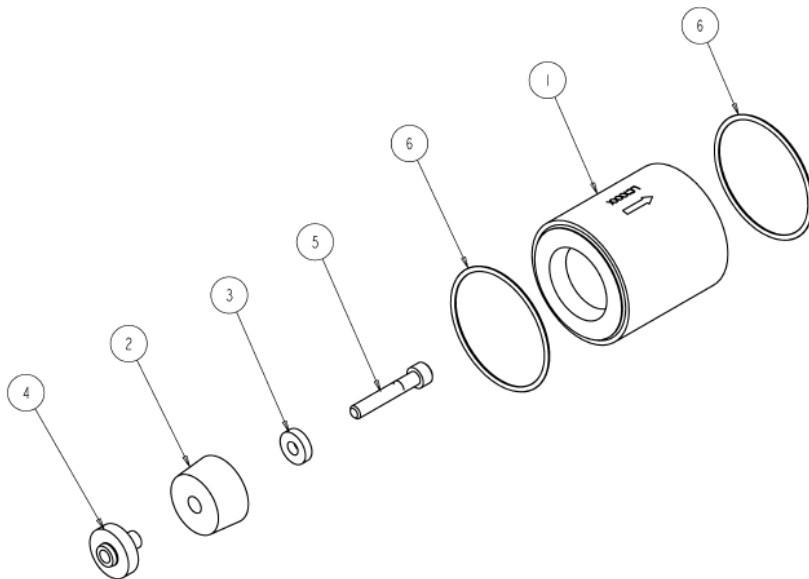

Front and Rear Washer Reference Guide		
Tube Area	Fr. Washer	Back Washer
080 to 119	15M089	NOT REQ
120 to 159	NOT REQ	NOT REQ
160 to 239	15M099	15K887
240 to 319	15M100	15K887
320 to 559	15M100	15K888
560 to 639	15M101	15K888
640 to 960	15M101	15K890

Figure 50: Available PR70 Piston and Cylinder (Metering Tubes) Kits

Key:

Ref	Description	QTY	Ref	Description	QTY
1	Cylinder or Metering Tube	1	4	Back Washer	See Fig.
2	Piston	1	5	Screw	1
3	Front Washer	See Fig.	6	O-ring	2



## Pistons

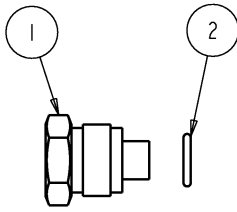

**Figure 51 PR70 Piston Plug Assembly**

### Key:

Ref	P/N	Description	QTY
1	15K815	Plug	2/Machine
2	111457	Oring	2/Machine

### To install a new Piston Plug Assembly:

1. Drain the machine pistons by instigating several shots with either the tank ball valves closed (if installed), or by activating enough shots to empty the tanks.

2. To prevent machine movement, press ● (red).
3. Remove the existing Piston plug (1) from the pump end cap (item 8 of figure 46) with a wrench. Remove the existing Oring (2).
4. Lubricate the new Oring with a high temperature grease, Graco P/N 115982 or equivalent. Place the lubricated Oring into the cap location of the end cap.
5. Re-install the piston plug (1) back into the end cap.
6. Open the tank ball valves (if installed) or put more material into the tanks.
7. Instigate several shot to fill the pump with new material.
8. Re-calibrate the machine, due to the procedure performed.

## Hose Assemblies

TABLE ONE												
REV.	PART NO.	SERIES	DESCRIPTION	STYLE	HOSE ASSY ITEM 1	QTY. EA.	ELBOW ITEM 2	QTY. EA.	ADAPTER ITEM 3	QTY. EA.	BUSHING ITEM 4	QTY. EA.
B	LC0801	A	Ø3/16X30"	FIGURE 1	16C501	1						
B	LC0802	A	Ø3/16X120"		16C506	1	94/0144-S/25	1	94/1000/98	1	94/0488/98	1
B	LC0803	A	Ø3/16X180"		16C507	1						
B	LC0804	A	Ø1/4X30"	FIGURE 2	16C510	1						
B	LC0805	A	Ø1/4X120"		16C515	1	94/0148-S/25	1	J6900040	1		
B	LC0806	A	Ø1/4X180"		16C516	1						
B	LC0807	A	Ø3/8X30"		16C519	1						
B	LC0808	A	Ø3/8X120"		16C524	1						
B	LC0809	A	Ø3/8X180"		16C525	1	94/0149-S/25	1	94/1007/98	1		
B	LC0490	A	Ø3/8X30", HP		16D261	1						
B	LC0491	A	Ø3/8X120", HP		16D266	1						
B	LC0492	A	Ø3/8X180", HP		16D267	1						
C	LC0810	A	Ø1/2X30"		16C529	1					NONE	0
C	LC0811	A	Ø1/2X120"	16C534	1							
C	LC0812	A	Ø1/2X180"	16C535	1	94/0150-S/25	1	16C399	1			
B	LC0493	A	Ø1/2X30", HP	16D271	1							
B	LC0494	A	Ø1/2X120", HP	16D276	1							
B	LC0495	A	Ø1/2X180", HP	16D277	1							
B	LC0813	A	Ø3/4X120"	16C544	1							
B	LC0814	A	Ø3/4X180"	16C545	1	94/0153-S/25	1	94/1083/98	1			
B	LC0496	A	Ø3/4X120", HP	16D286	1							
B	LC0497	A	Ø3/4X180", HP	16D287	1							

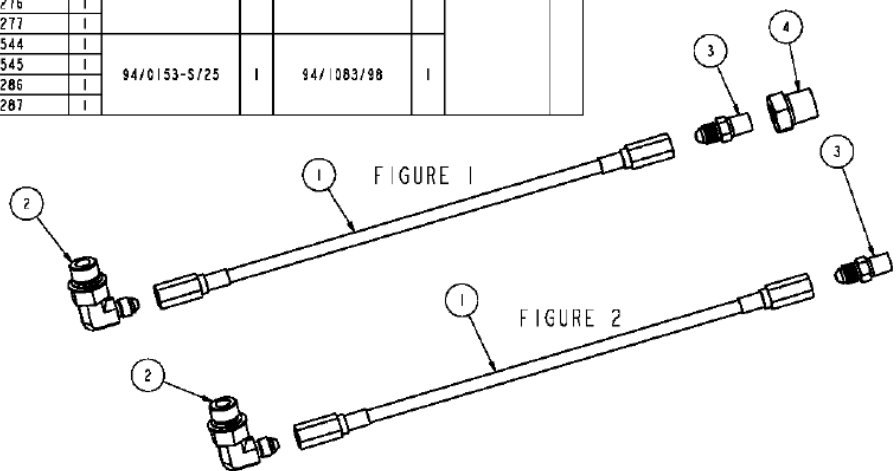

**Figure 52 Piston to DV Hose Assemblies**

## Hose Assemblies

PART NO.	REV	DESCRIPTION	HEATED HOSE ASSY	ELBOW, 90°	ADAPTER	ELBOW, 45°	CIRCUIT BREAKER	EXT CORD
			ITEM 1	ITEM 2	ITEM 3	ITEM 4	ITEM 5	ITEM 6
LC0881	C	∅ 1/4X30"	16C554				121630	
LC0882	C	∅ 1/4X120"	16C558	94/0148-S/25	J6900040	121041	121632	
LC0883	C	∅ 1/4X180"	16C559				121633	
LC0884	B	∅ 3/8X30"	16C562				121630	
LC0885	C	∅ 3/8X120"	16C566	94/0149-S/25	94/1007/98	121042	121632	121683
LC0886	C	∅ 3/8X180"	16C567				16E546	
LC0887	D	∅ 1/2X30"	16C570				121630	
LC0888	E	∅ 1/2X120"	16C574	94/0150-S/25	16C399	121043	121632	
LC0889	F	∅ 1/2X180"	16C575				16E546	
LC0890	D	∅ 3/4X120"	16C582	94/0153-S/25	94/1083/98	121044	121632	
LC0891	D	∅ 3/4X180"	16C583				16E546	

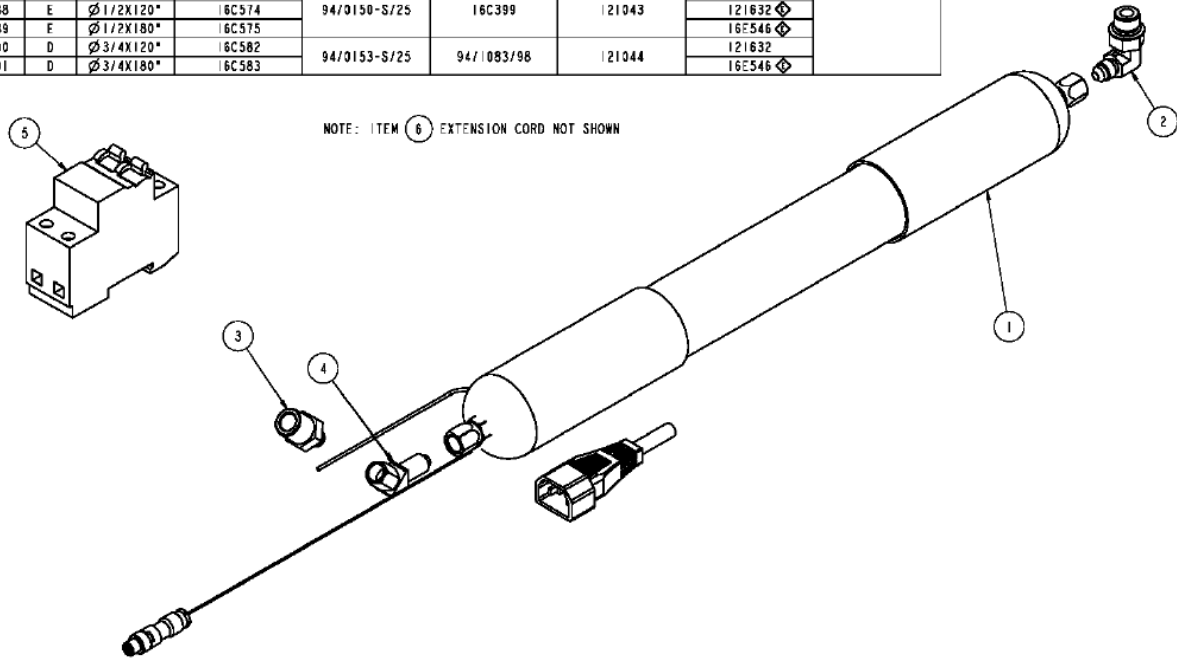
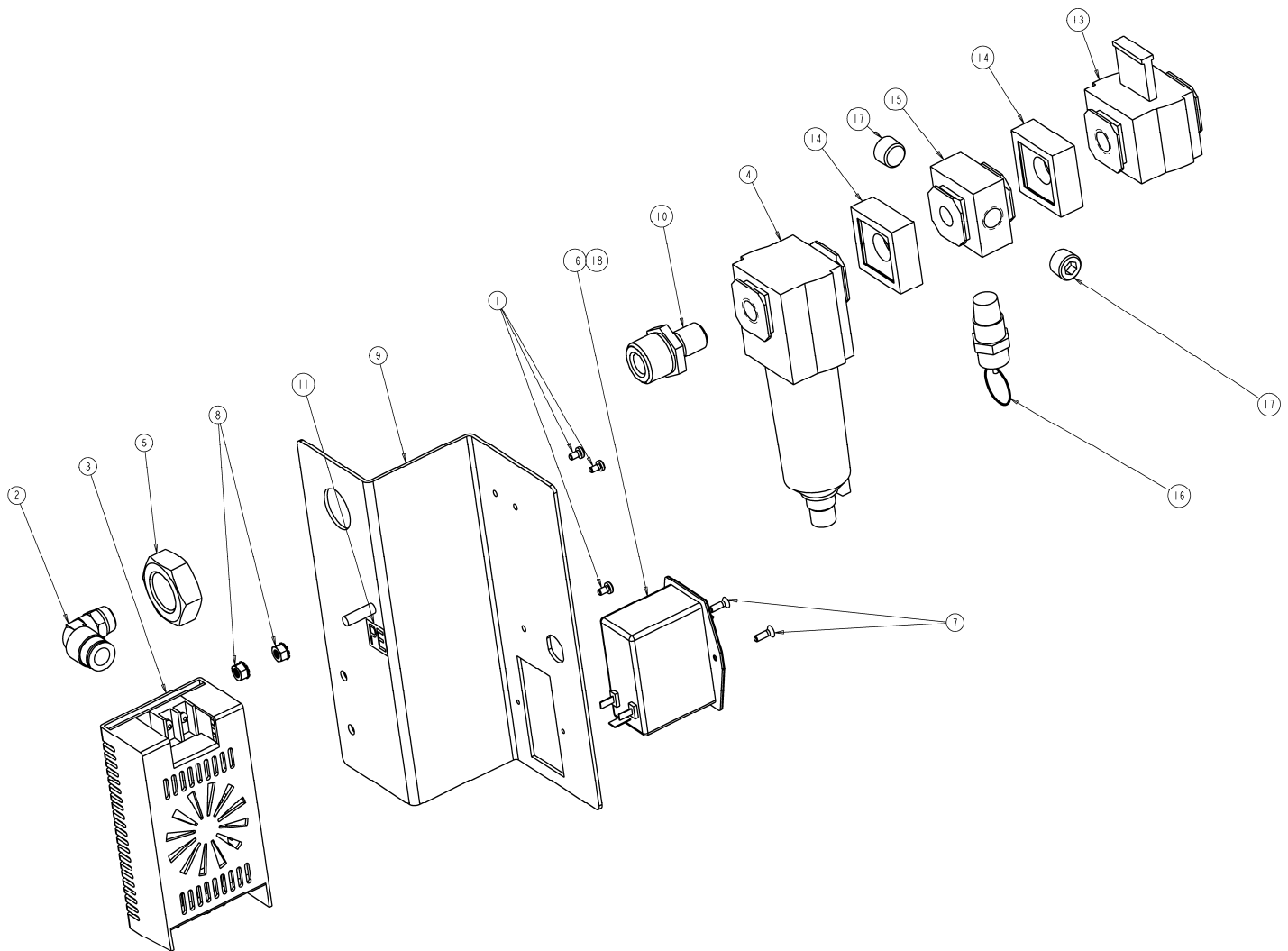

Figure 53 Heated Piston to DV Hose Assemblies

**Miscellaneous Mechanical Assemblies**



**Figure 54: PR70 Power Entry Bracket Assembly (LC0106)**

**Key:**

Ref	P/N	Description	QTY	Ref	P/N	Description	QTY
1	119912	SCREW, PAN, M3X6, PHILLIPS, SS	3	11	84/0130-26/11	LABEL, PE	1
2	121018	ELBOW, SWVL, 3/8 X 1/4 NPT, FXM, 90DE	1	12	LC0034	HARNESS, WIRE, REMOTE SIGNAL	1
3	120876	PWR SUPPLY, 24VDC, 40W, 100-240VAC IN	1	13	121178	VALVE, LOCKOUT, 1/4 NPT	1
4	120882	FILTER, 1/4NPT	1	14	121179	QUICKCLAMP, 1/4 NPT	2
5	120883	NUT, HEX, 7/8-14, MS	1	15	121180	MULTIPORT, [3] 1/4 NPT	1
6	120910	PWR ENTRY, 120/240VAC, DUAL FUSE, EMI	1	16	94/0762/99	VALVE, RELIEF, 1/4 NPT, M, 110PSI, SIL	1
7	120916	SCREW, FHSC, M3X0.5 X 10, SS	2	17	94/0430/99	PLUG, SKT HD, 1/4 NPT, MS	2
8	120993	NUT, HEX, M5X0.8, WITH STAR WASHER	2	18	81/1054-4/11	FUSE 5X20MM, 4AMP, FAST, TYPE F, 250VAC	2
9	15K798	BRACKET, SWITCH, AIR	1	19	LC0031	CABLE ASSY, POWER IN	1
10	15K800	FITTING, BULKHEAD	1				

**To Replace the Fuses:**

1. Remove the machine fuse holder from the PWR Entry module (6) by inserting a flat-head screwdriver between the holder and the back the PWR Entry module (The fuse holder is above where AC power is connected to the machine).
2. Replace the blown fuse(s) (18) into the fuse holder.
3. Re-install the holder into the PWR Entry Module.

Miscellaneous Assemblies

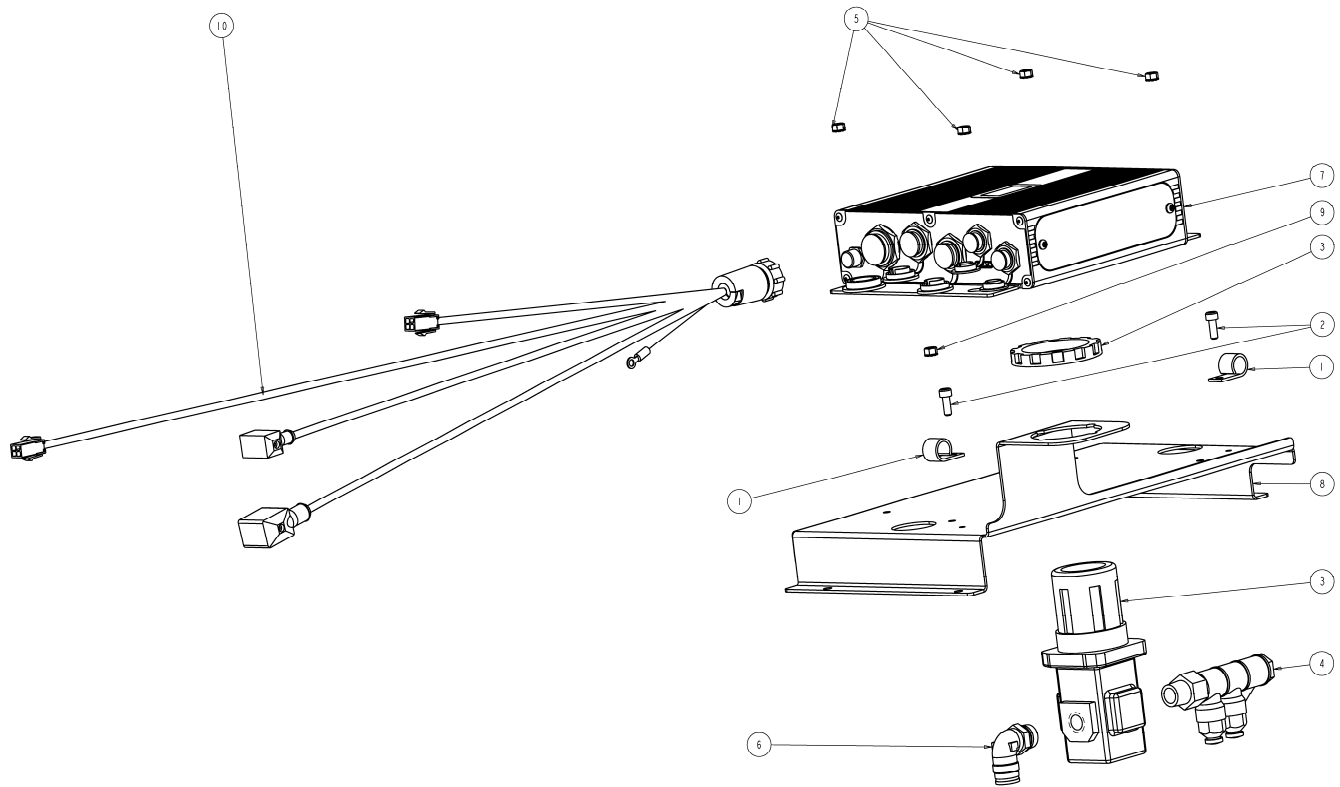

**Figure 55: PR70 Control Bracket Assembly (LC0108)**

**Key:**

Ref	P/N	Description	QTY	Ref	P/N	Description	QTY
1	84/0153-1/89	CLAMP, HARNESS, REUSEABLE, 5/8,NYL	2	6	121019	ELBOW, SWVL, 3/8 X 3/8 NPT, FXM, 90DE	1
2	120885	SCREW, SHC, M5-0.8 X 14, MS, E	2	7	LC0124	CONTROLLER, FCM	1
3	120897	REGULATOR, 100PSI, 3/8NPT, GAGE	1	8	15K797	BRACKET, ELECTRICAL,	1
4	120954	MANIFOLD, PN, 3/8NPTX3/8T X 1/4 TX1/4T	1	9	84/0130-25/11	LABEL, .375X.375	1
5	120993	NUT, HEX, M5X0.8, WITH STAR WASHER	5	10	LC0035	HARNESS, WIRE, I/O	1

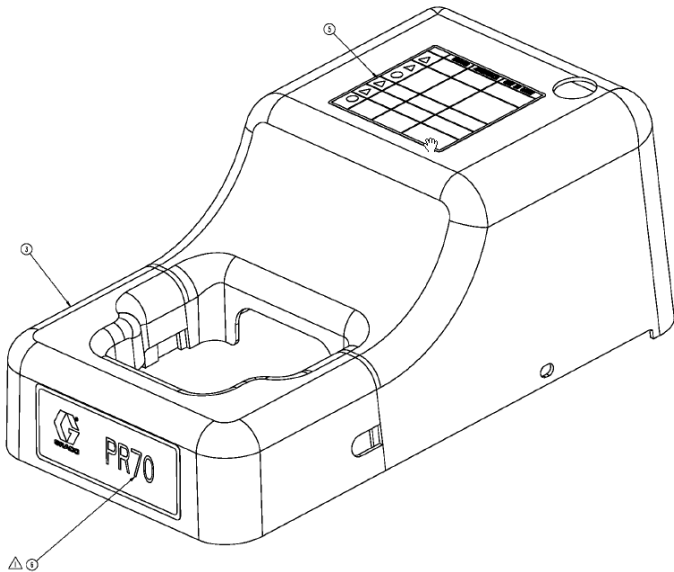
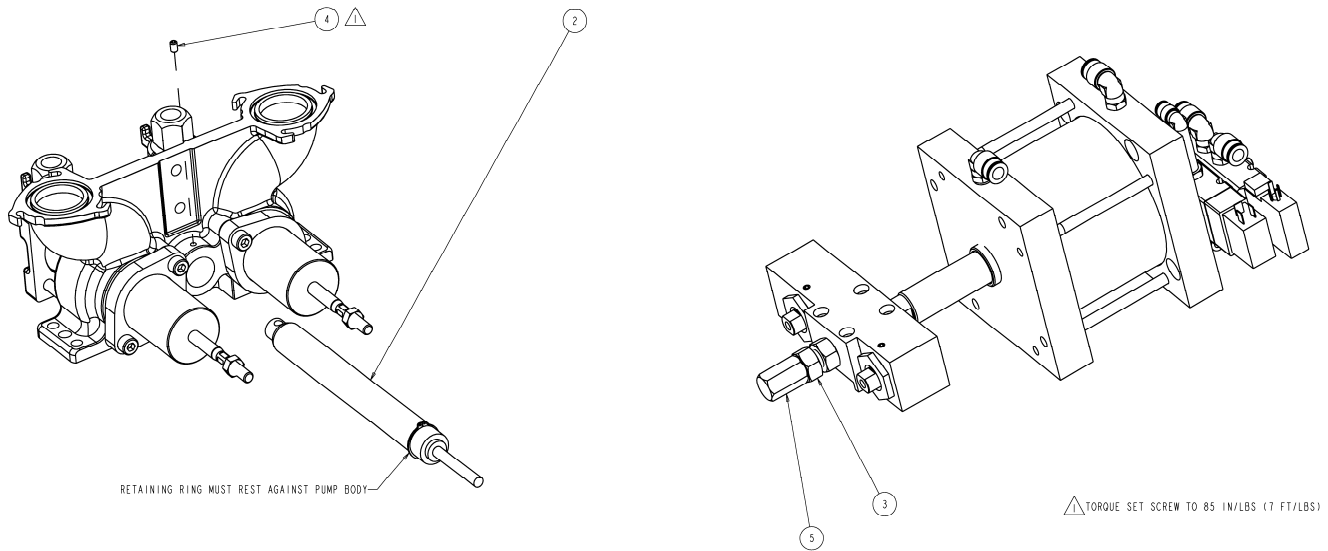

**Figure 56: PR70 Shroud Assembly (LC0113)**

**Key:**

Ref	P/N	Description	QTY
1	15V962	SHIELD, PR70, FIXED RATIO, GCA	1
2	15M511	LABEL, WARNING	4
3	16P016	PR70, FIXED RATIO	1

Miscellaneous Assemblies



	DESCRIPTION	ITEM 1	ITEM 2	QTY	ITEM 3	QTY	ITEM 4	QTY	ITEM 5
LC0000	3.0 A/C NO HYDRACHECK	LC0110	N/A	N/A	120919	1	N/A	N/A	N/A
LC0001	3.0 A/C W/HYDRACHECK	LC0110	120920	1	120919	3	111260	1	15K816
LC0002	4.5 A/C NO HYDRACHECK	LC0111	N/A	N/A	120919	1	N/A	N/A	N/A
LC0003	4.5 A/D W/HYDRACHECK	LC0111	120920	1	120919	3	111260	1	15K816

Figure 57: PR70 Hydracheck Components

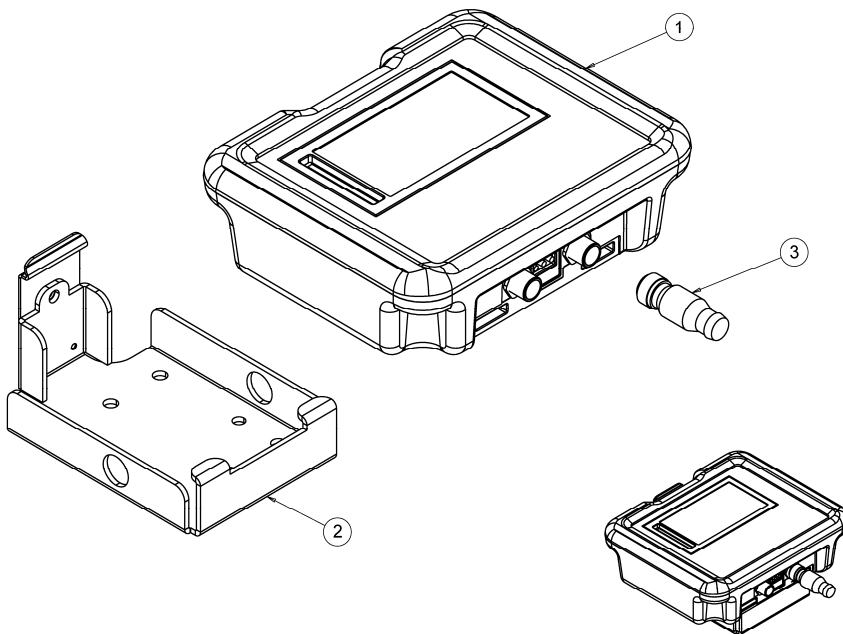

Figure 58: PR70 HMI Components

Key:

Ref	P/N	Description	QTY	Ref	P/N	Description	QTY
1	288446	Display Module, PR70	1	3	120999	Termination Plug	1
2	255235	Bracket, HMI	1				

# Wiring Diagrams

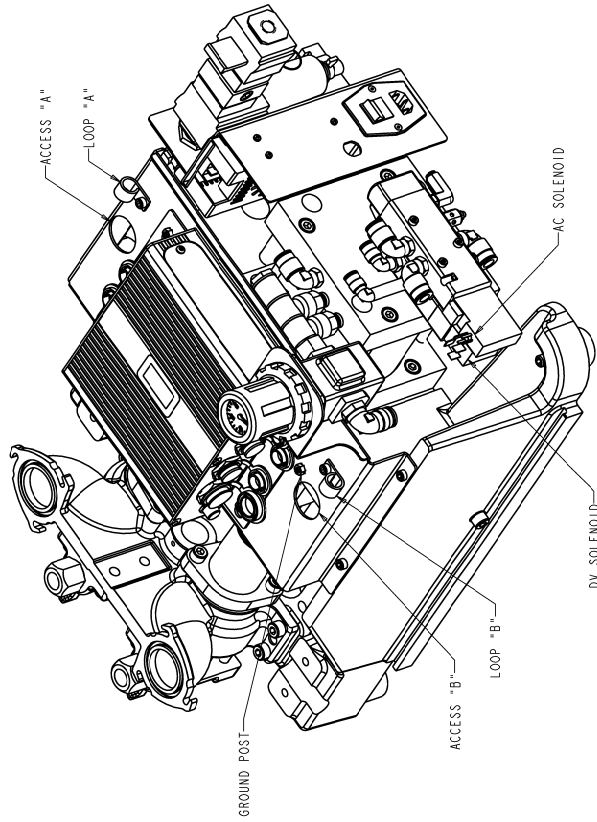
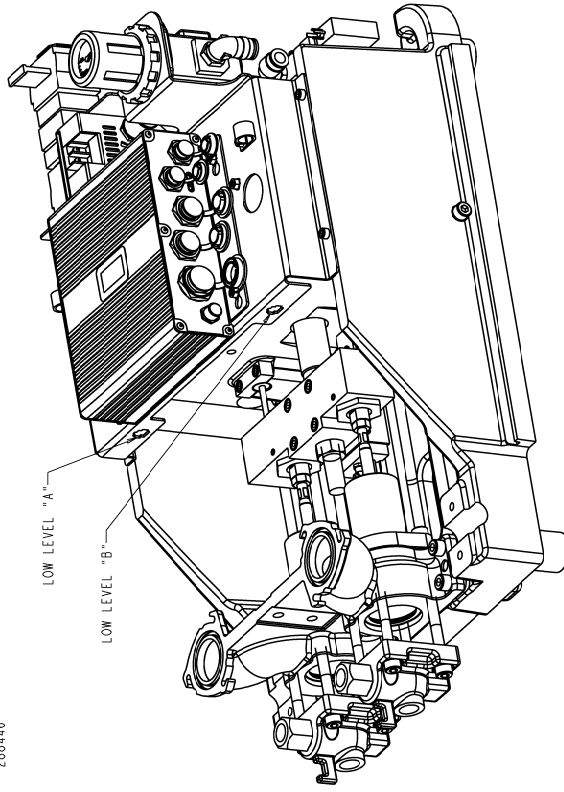
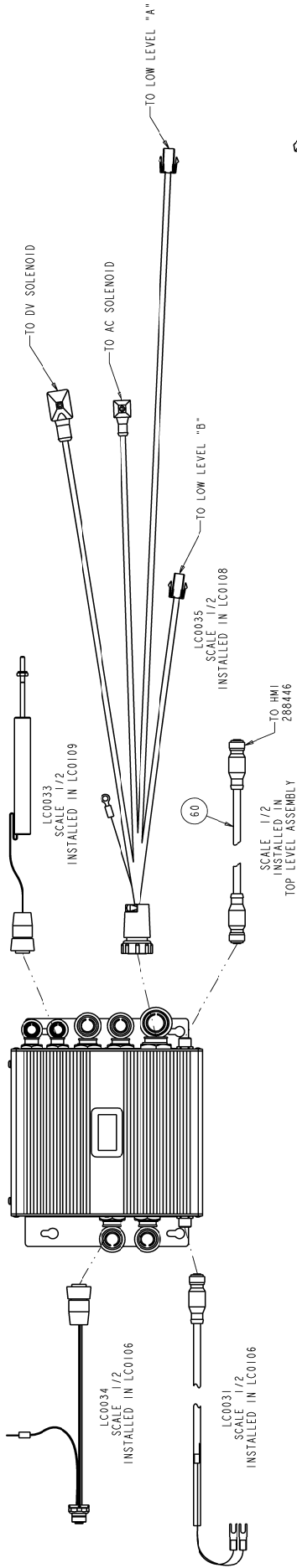

Figure 59: PR70 Wiring Interconnect Illustration

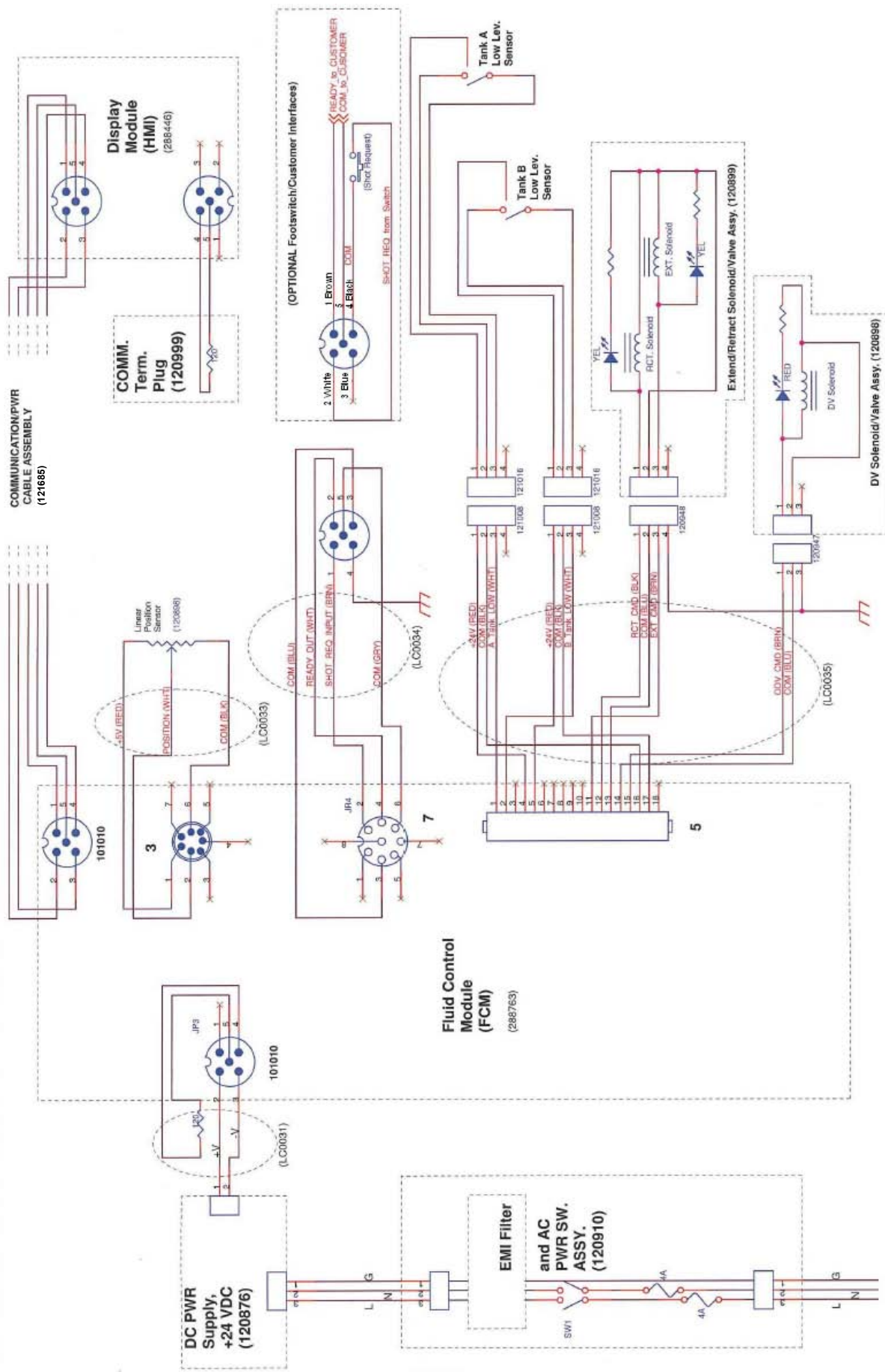

Figure 60: Wiring Diagram, PR70

## Technical Data

Category	Data
Metering Pump Effective Area	80 – 960 mm <sup>2</sup> (0.124 – 1.49 in <sup>2</sup> ) per side
Small Air Cylinder Effective Area	4560 mm <sup>2</sup> (7.07 in <sup>2</sup> )
Large Air Cylinder Effective Area	10260 mm <sup>2</sup> (15.9 in <sup>2</sup> )
Maximum Stroke Length	38.1 mm (1.50 in)
Minimum Stroke Length	5.8 mm (0.23 in)
Volume per Cycle	2 – 70 cc (0.12 – 4.3 in <sup>3</sup> )
Pump Cycles per 1L (0.26 gal)	500 – 14.3
Ratios (fixed)	1:1 to 12:1 (depending upon cylinders selected)
Maximum Fluid Working Pressure	3000 psi (20.7 MPa, 207 bar)
Maximum Air Input Pressure	100 psi (0.7 MPa, 7 bar)
Maximum Cycle Rate	30 cpm
Maximum Operating Temperature	70 C (160 F), nylon pistons 50 C (120 F) UHMWPE pistons or PE Tanks
Air Inlet Size	¼ NPT (f)
Pump Fluid Outlet Size	-03, -04, -06, -08 or -12 JIC fittings for 3/16 in (4.8 mm), ¼ in (6.4 mm), 3/8 in (9.5 mm), ½ in (12.7 mm), ¾ in (19.1 mm) hoses
Wetted Parts	303/304, 17-4 PH, hard chrome, Chromex, carbide, Chemical Resistant O-rings, PTFE, nylon, UHMWPE
Weight	55 kg (120 Lbs) typical with two 7.5L tanks 150 kg (330 Lbs) typical with two 60 L tanks
Sound Power Level 4 in Air Cylinder Measured Per ISO Standard 9614-2	100 psi/30 cpm - 81 dBA 50 psi/15cpm – 77 dBA
Compressed Air	< 10 scfm typical (varies with cycle times)
Electrical Power	100-240 V 50/60Hz, 1 phase for machine – 80 Watts 208-240V 50/60Hz, 1 phase for heat – 11 kW max. 120 or 240 VAC 50/60Hz 1 phase for on-board agitators, 80 Watts 240 VAC 50/60Hz 1 phase for off-board agitators, 830 Watts



## Dimensions

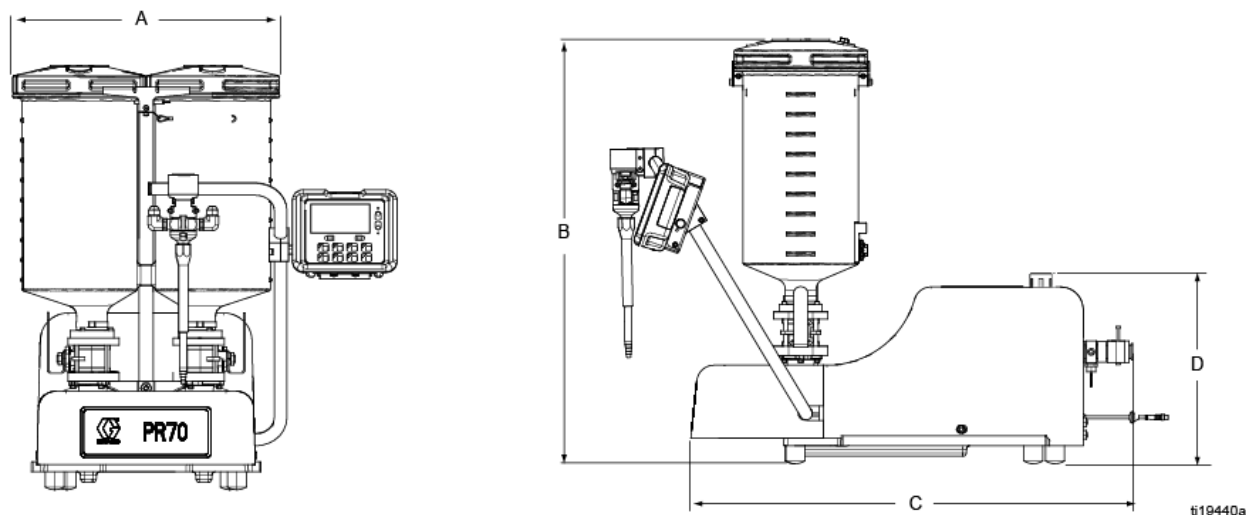

**Figure 36: PR70 Dimensions (ON-Board PE Tank version Illustrated)**

A typical PR70 Machine, with the standard On-Board twin 8 liter PE Tanks has the following dimensions:

Dimension	In. (mm)	Dimension	In. (mm)
A (width)	18.49 (469.6)	C (depth)	30.62 (777.7)
B (height)	26.39 (670.3)	D (height in Back)	13.39 (340.1)

A typical PR70 Machine, with the standard On-Board 7.5 liter Stainless Steel Tanks has the following dimensions:

Dimension	In. (mm)	Dimension	In. (mm)
A (width)	15.5 (393.7)	C (depth)	30.62 (777.7)
B (height)	27.37 (695.2)	D (height in Back)	13.39 (340.1)

## Graco Ohio Standard Warranty

Graco warrants all equipment referenced in this document which is manufactured by Graco and bearing its name to be free from defects in material and workmanship on the date of sale to the original purchaser for use. With the exception of any special, extended, or limited warranty published by Graco, Graco will, for a period of twelve months from the date of sale, repair or replace any part of the equipment determined by Graco to be defective. This warranty applies only when the equipment is installed, operated and maintained in accordance with Graco's written recommendations.

This warranty does not cover, and Graco shall not be liable for general wear and tear, or any malfunction, damage or wear caused by faulty installation, misapplication, abrasion, corrosion, inadequate or improper maintenance, negligence, accident, tampering, or substitution of non-Graco component parts. Nor shall Graco be liable for malfunction, damage or wear caused by the incompatibility of Graco equipment with structures, accessories, equipment or materials not supplied by Graco, or the improper design, manufacture, installation, operation or maintenance of structures, accessories, equipment or materials not supplied by Graco.

This warranty is conditioned upon the prepaid return of the equipment claimed to be defective to an authorized Graco distributor for verification of the claimed defect. If the claimed defect is verified, Graco will repair or replace free of charge any defective parts. The equipment will be returned to the original purchaser transportation prepaid. If inspection of the equipment does not disclose any defect in material or workmanship, repairs will be made at a reasonable charge, which charges may include the costs of parts, labor, and transportation.

**THIS WARRANTY IS EXCLUSIVE, AND IS IN LIEU OF ANY OTHER WARRANTIES, EXPRESS OR IMPLIED, INCLUDING BUT NOT LIMITED TO WARRANTY OF MERCHANTABILITY OR WARRANTY OF FITNESS FOR A PARTICULAR PURPOSE.**

Graco's sole obligation and buyer's sole remedy for any breach of warranty shall be as set forth above. The buyer agrees that no other remedy (including, but not limited to, incidental or consequential damages for lost profits, lost sales, injury to person or property, or any other incidental or consequential loss) shall be available. Any action for breach of warranty must be brought within two (2) years of the date of sale.

**GRACO MAKES NO WARRANTY, AND DISCLAIMS ALL IMPLIED WARRANTIES OF MERCHANTABILITY AND FITNESS FOR A PARTICULAR PURPOSE, IN CONNECTION WITH ACCESSORIES, EQUIPMENT, MATERIALS OR COMPONENTS SOLD BUT NOT MANUFACTURED BY GRACO.** These items sold, but not manufactured by Graco (such as electric motors, switches, hose, etc.), are subject to the warranty, if any, of their manufacturer. Graco will provide purchaser with reasonable assistance in making any claim for breach of these warranties.

In no event will Graco be liable for indirect, incidental, special or consequential damages resulting from Graco supplying equipment hereunder, or the furnishing, performance, or use of any products or other goods sold hereto, whether due to a breach of contract, breach of warranty, the negligence of Graco, or otherwise.

### **FOR GRACO CANADA CUSTOMERS**

The Parties acknowledge that they have required that the present document, as well as all documents, notices and legal proceedings entered into, given or instituted pursuant hereto or relating directly or indirectly hereto, be drawn up in English. Les parties reconnaissent avoir convenu que la rédaction du présente document sera en Anglais, ainsi que tous documents, avis et procédures judiciaires exécutés, donnés ou intentés, à la suite de ou en rapport, directement ou indirectement, avec les procédures concernées.

## Graco Information

For the latest information about Graco products, visit [www.graco.com](http://www.graco.com).

**TO PLACE AN ORDER**, contact your Graco distributor or call to identify the nearest distributor.

**Toll Free:** 1-800-746-1334 **or Fax:** 330-966-3006

*All written and visual data contained in this document reflects the latest product information available at the time of publication.  
Graco reserves the right to make changes at any time without notice.*

For patent information, see [www.graco.com/patents](http://www.graco.com/patents).

Original instructions. *This manual contains English. MM 312393*

**Graco Headquarters:** Minneapolis

**International Offices:** Belgium, China, Japan, Korea

**GRACO INC. AND SUBSIDIARIES • P.O. BOX 1441 • MINNEAPOLIS MN 55440-1441 • USA**

Copyright 2007, Graco Inc. All Graco manufacturing locations are registered to ISO 9001.

[www.graco.com](http://www.graco.com)

Revised November 2013

## Free Manuals Download Website

<http://myh66.com>

<http://usermanuals.us>

<http://www.somanuals.com>

<http://www.4manuals.cc>

<http://www.manual-lib.com>

<http://www.404manual.com>

<http://www.luxmanual.com>

<http://aubethermostatmanual.com>

Golf course search by state

<http://golfingnear.com>

Email search by domain

<http://emailbydomain.com>

Auto manuals search

<http://auto.somanuals.com>

TV manuals search

<http://tv.somanuals.com>