

iHome™

Model iH52
The Home System
For Your iPod®

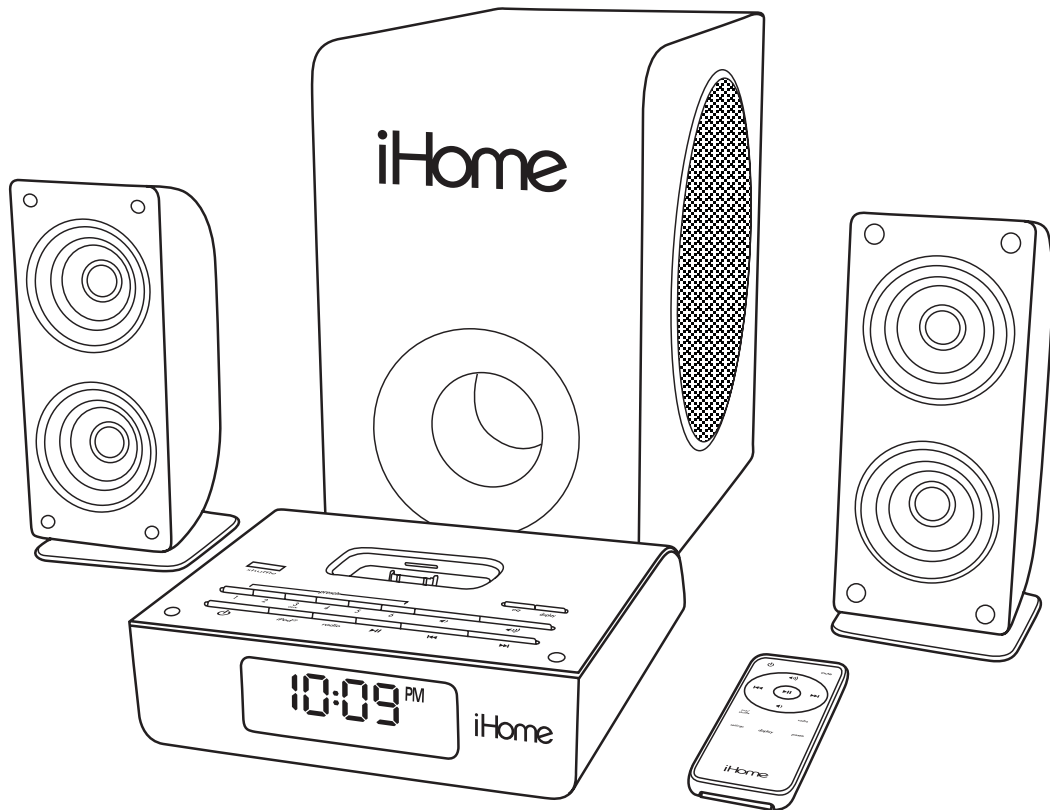

Questions? Visit www.ihomeaudio.com

Download from Www.Somanuals.com. All Manuals Search And Download.

Table of Contents

Caution Information	1
A Consumer Guide to product Safety	2-5
Safety Instructions	
FCC Information	
Quick Start	6-7
Controls and Indicators	8
Using the iH52	9-11
Replacing iH52 Backup Batteries	11
Install/Replace Backup Battery	
Batteries information	
Using The Remote Control Unit	12
Troubleshooting	13-14
Solucionando problemas	15-16
Warranty Information	17

Package Contents

Congratulations on your iH52 home sound system for the iPod. Before you set up your unit, please check to see that the package contains the following items:

- 1 Subwoofer
- 1 Receiver with 3 AA batteries (pre-installed) for clock battery backup
- 1 connector cable (connects subwoofer to receiver)
- 2 Stereo speakers with thumbscrew mount stands
- 2 sets speaker cables
- 1 remote control with 2 CR2032 batteries
- 1 FM antenna
- 1 AM antenna with stand
- 1 audio patch cord
- 3 iPod inserts



CAUTION
RISK OF ELECTRIC SHOCK
DO NOT OPEN



CAUTION: TO REDUCE THE RISK OF ELECTRIC SHOCK, DO NOT REMOVE COVER (OR BACK). NO USER-SERVICEABLE PARTS INSIDE. REFER SERVICING TO QUALIFIED SERVICE PERSONNEL.

WARNING: TO REDUCE THE RISK OF FIRE OR ELECTRIC SHOCK, DO NOT EXPOSE THIS APPLIANCE TO RAIN OR MOISTURE.



The lightning flash with arrowhead symbol, within an equilateral triangle, is intended to alert the user of the presence of uninsulated “dangerous voltage” within the product’s enclosure that may be of sufficient magnitude to constitute a risk electric shock to persons.



The exclamation point within an equilateral triangle is intended to alert the user of the presence of important operating and maintenance (servicing) instructions in the literature accompanying the appliance.

The symbols above are located on the rear of the subwoofer.

WARNING: DANGER OF EXPLOSION IF BATTERY IS INCORRECTLY REPLACED.
REPLACE ONLY WITH THE SAME OR EQUIVALENT TYPE.

AVERTISSEMENT: DANGER D’EXPLOSION LORSQUE LA BATTERIE N’EST PAS
REPLACÉE CORRECTEMENT.
REPLACER UNIQUEMENT AVEC DES BATTERIES IDENTIQUES OU D’UN TYPE ÉQUIVALENT.

CAUTION: To prevent electric shock, match wide blade of plug to wide slot. Fully insert.

CAUTION: To reduce the risk of fire, do not place any heating or cooking product beneath this unit

IMPORTANT SAFETY INSTRUCTIONS

When used in the directed manner, this unit has been designed and manufactured to ensure your personal safety. However, improper use can result in potential electrical shock or fire hazards. Please read all safety and operating instructions carefully before installation and use, and keep these instructions handy for future reference. Take special note of all warnings listed in these instructions and on the unit.

1. **Water and Moisture** – The unit should not be used near water. For example: near a bathtub, washbowl, kitchen sink, laundry tub, swimming pool or in a wet basement.
2. **Ventilation** – The unit should be situated so that its location or position does not interfere with its proper ventilation. For example, it should not be situated on a bed, sofa, rug or similar surface that may block ventilation openings. Also, it should not be placed in a built-in installation, such as a bookcase or cabinet, that may impede the flow of air through the ventilation openings.
3. **Heat** – The unit should be situated away from heat sources such as radiators, heat registers, stoves or other appliances (including amplifiers) that produce heat.
4. **Power Sources** – The unit should be connected to a power supply only of the type described in the operating instructions or as marked on the appliance.
5. **Grounding or Polarization** – This product is equipped with a polarized alternating current line plug. (a plug having one blade wider than the other) As a safety feature this plug will fit into the power outlet only one way. If you are unable to fit the plug fully into the outlet, try reversing the plug. If the plug still fails to fit, contact your electrician to replace your obsolete outlet. Do not defeat the safety purpose of the polarized plug by forcing the plug into the outlet
6. **Power-Cord Protection** – Power supply cords should be routed so that they are not likely to be walked on or pinched by items placed upon or against them. It is always best to have a clear area from where the cord exits the unit to where it is plugged into an AC outlet.
7. **Cleaning** – The unit should be cleaned only as recommended. See the Maintenance section of this manual for cleaning instructions.

8. **Outdoor Antenna Grounding** - If an outside antenna is connected to the receiver, be sure the antenna system is grounded so as to provide some protection against voltage surges and build-up static charges. Article 810 of the National Electrical Code, ANSI/NFPA 70, provides information with regard to proper grounding of the mast and supporting structure, grounding of the mast and supporting structure, grounding of the lead-in wire to an antenna-discharge unit, size of grounding conductors, location of antenna-discharge unit, connection to grounding electrodes, and requirements for the grounding electrode.

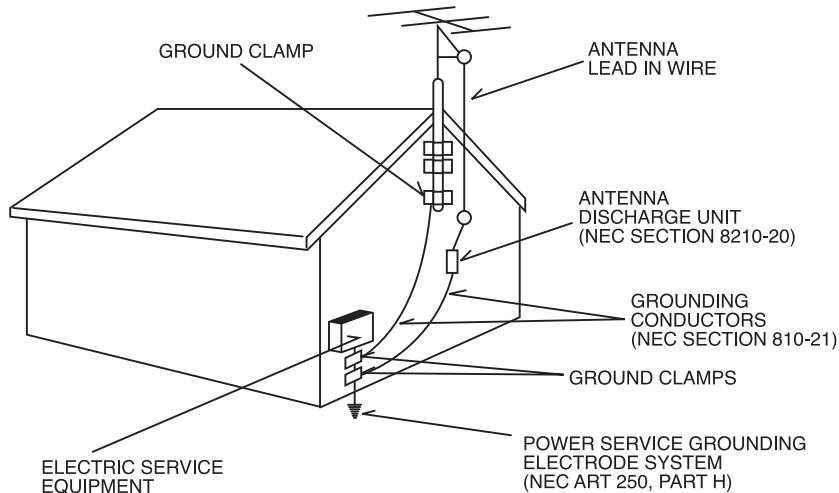

9. **Power Lines** - An outside antenna system should not be located in the vicinity of overhead power lines or other electric light or power circuits, or where it can fall into such power lines or circuits. When installing an outside antenna system, extreme care should be taken to keep from touching such power lines or circuits as contact with them might be fatal.

10. **Objects and Liquid Entry** – Care should be taken so that objects do not fall and liquids are not spilled into any openings or vents located on the product.
11. **Attachments** – Do not use attachments not recommended by the product manufacturer.
12. **Lightning and Power Surge Protection** – Unplug the unit from the wall outlet and disconnect the antenna or cable system during a lightning storm or when it is left unattended and unused for long periods of time. This will prevent damage to the product due to lightning and power-line surges.
13. **Overloading** – Do not overload wall outlets, extension cords, or integral convenience receptacles as this can result in a risk of fire or electric shock.
14. **Damage Requiring Service** – The unit should be serviced by qualified service personnel when:
 - A. the power supply cord or plug has been damaged.
 - B. objects have fallen into or liquid has been spilled into the enclosure.
 - C. the unit has been exposed to rain.
 - D. the unit has been dropped or the enclosure damaged.
 - E. the unit exhibits a marked change in performance or does not operate normally.
15. **Antenna** – Do not connect an external antenna to the unit (other than that provided).
16. **Periods of Nonuse** – If the unit is to be left unused for an extended period of time, such as a month or longer, the power cord should be unplugged from the unit to prevent damage or corrosion.
17. **Servicing** – The user should not attempt to service the unit beyond those methods described in the user's operating instructions. Service methods not covered in the operating instructions should be referred to qualified service personnel.
18. **Replacement Parts** – When replacement parts are required, be sure the service technician has used replacement parts specified by the manufacturer or have the same characteristics as the original part. Unauthorized substitutions may result in fire, electric shock, or other hazards.
19. **Safety Check** – Upon completion of any service or repairs to this product, ask the service technician to perform safety checks to determine that the product is in proper operating condition.

Questions? Visit www.ihomeaudio.com

For operating instructions: 1-877-ihome01(1-877-446-6301) Toll Free

For any other questions: 1-800-288-2792 Toll Free

FCC Information

This device complies with Part 15 of the FCC Rules. Operation is subject to the following two conditions:

(1) this device may not cause harmful interference, and (2) this device must accept any interference received, including interference that may cause undesired operation.

Warning: Changes or modifications to this unit not expressly approved by the party responsible for compliance could void the user's authority to operate the equipment.

NOTE: This equipment has been tested and found to comply with the limits for a Class B digital device, pursuant to Part 15 of the FCC Rules. These limits are designed to provide reasonable protection against harmful interference in a residential installation. This equipment generates, uses and can radiate radio frequency energy and, if not installed and used in accordance with the instructions, may cause harmful interference to radio communications.

However, there is no guarantee that interference will not occur in a particular installation. If this equipment does cause harmful interference to radio or television reception, which can be determined by turning the equipment off and on, the user is encouraged to try to correct the interference by one or more of the following measures:

- Reorient or relocate the receiving antenna.

- Increase the separation between the equipment and receiver.

- Connect the equipment into an outlet on a circuit different from that to which the receiver is needed.

- Consult the dealer or an experienced radio/TV technician for help.

SDI TECHNOLOGIES INC.

1299 Main Street, Rahway, NJ 07065

Tel. No. (732) 574-9000

Questions? Visit www.ihomeaudio.com

For operating instructions: 1-877-ihome01(1-877-446-6301) Toll Free

For any other questions: 1-800-288-2792 Toll Free

quick start: connections

1:subwoofer

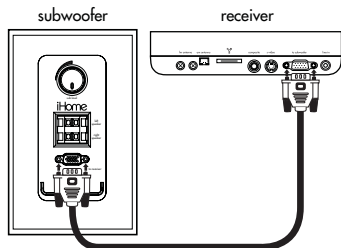

Connect provided connector cable from the back of the Subwoofer to the back of the Receiver and tighten screws.

2:speakers

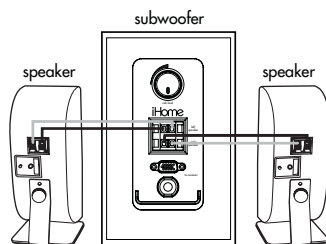

Attach a pair of speaker wires from the matching red and black terminals on the Subwoofer to those on each speaker (red to red, black to black).

3:antennas

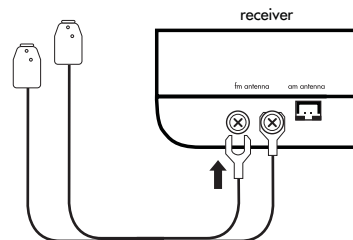

- Snap the AM antenna into the provided stand, then plug antenna cable into AM antenna plug on rear of receiver. Antenna should be kept 12 inches from unit.
- Use a Phillips screwdriver to loosen the two FM antenna pole screws on the rear of the receiver. Insert FM antenna leads and tighten screws. Locate FM antenna for best reception. Do not alter antenna wire.

4:video outs

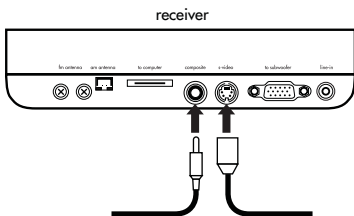

If you wish, plug the appropriate video cable (not included) from either the composite video output or S-video output jack to a VCR or Monitor video in jack.

5:power

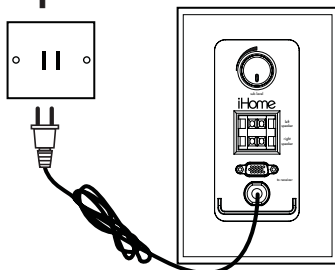

Plug AC cable on back of the iH52 subwoofer into a working wall socket

quick start

6:inserts

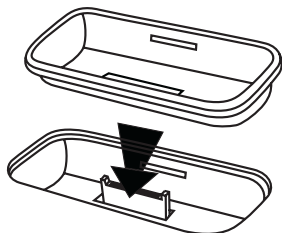

Select the insert that matches your iPod (see table below) and place in universal dock.

7:iPod

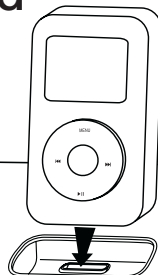

Insert iPod into dock (iPod must not be in a skin or case). The iPod will charge while docked. To play, press the iPod Button on iH52 to select iPod mode. Press the Play Button.

8:shuffle

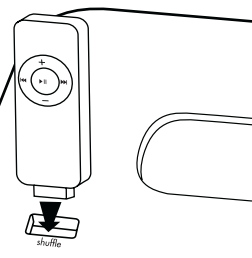

Insert iPod shuffle into shuffle dock. Shuffle will charge while docked. To play your shuffle, press the iPod Button on iH52 to select shuffle mode. Turn on shuffle, press play on shuffle.

Table 1: Selecting an Insert

ALWAYS USE AN INSERT TO DOCK YOUR iPod

iPod photo thin (20,30 GB) Insert 6	iPod photo thick (40,60 GB) Insert 7	iPod nano Insert 8	iPod with video (30 GB) Insert 9	iPod with video (60 GB) Insert 10
thin (20,30GB) iPod photo	thick (40,60GB) iPod photo	iPod nano	thin 30 GB iPod with video	thick 60 GB iPod with video

NOTE: If you do not have an insert for your model iPod, please visit an Apple store, www.ihomeaudio.com, or call iHome toll free at 800-288-2792 to purchase one

THIS UNIT DOES NOT CHARGE OR CONTROL 3G iPod

Controls and Indicators

RECEIVER (top panel)

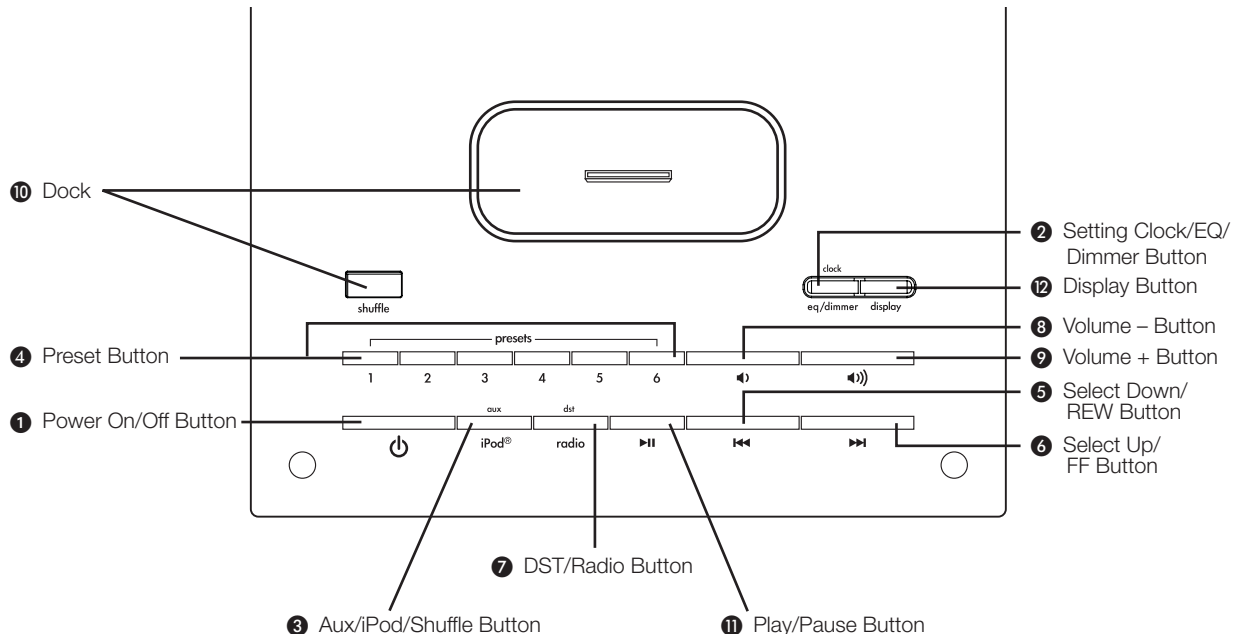

RECEIVER (rear panel)

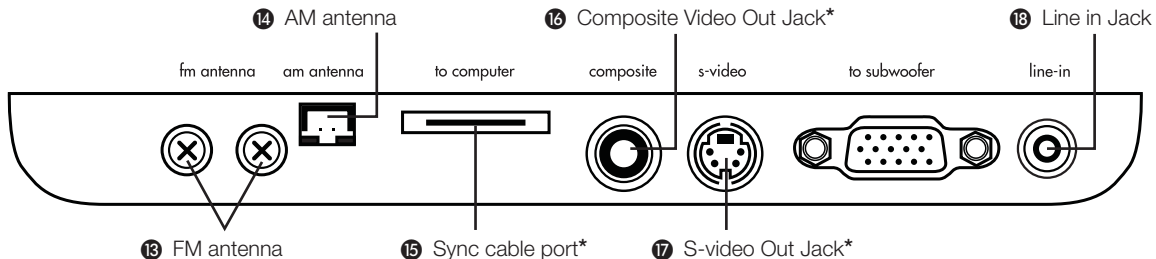

* cables not included

Connections

Connecting the Subwoofer to the Receiver

- The iH52 comes with a connector cable to connect the Subwoofer to the Receiver. DO NOT USE THIS CABLE TO CONNECT ANY OTHER DEVICE, SUCH AS A COMPUTER. DOING SO WILL DAMAGE YOUR UNIT.
- Attach one end of the cable to the Subwoofer and tighten the screws until firmly attached.
- Attach the other end of the cable to the Receiver and tighten screws until firmly attached.

Connecting and setting up the speakers

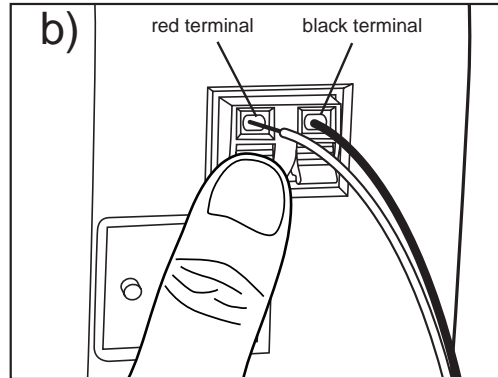
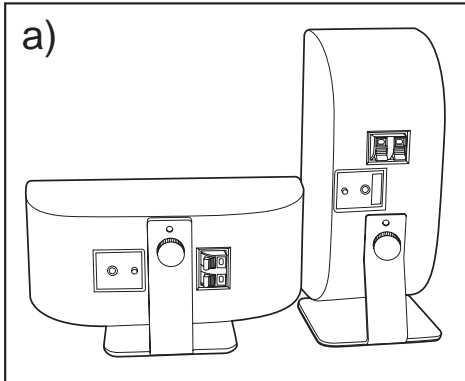

- You can configure your speakers horizontally or vertically with the included mounting stands. Fit the stand to the back of the speaker with the small pin in the top hole of the stand mount and the thumbscrew in the bottom hole. Tighten the thumbscrew.
- Press down on the red speaker terminal lever on the back of a speaker and insert the stripped part of the red wire. Press down on the black speaker terminal lever on the back of the speaker and insert the black wire. Do the same for the remaining speaker.
- Attach the matching ends of the black and red speaker wire from the speaker on the left to matching black and red left speaker terminals on the back of the subwoofer. Do the same for the right speaker.

Connecting and setting up the antennas

- Snap the AM antenna into the provided stand, then plug antenna cable into AM antenna plug on rear of receiver. Antenna should be kept 12 inches from unit.
- Use a Phillips screwdriver to loosen the two FM antenna pole screws on the rear of the receiver. Insert FM antenna leads and tighten screws. Locate FM antenna for best reception. Do not alter antenna wire.

Connecting iH52 to Power Source

- Once you've made all your connections, plug the power cable from the Subwoofer into a standard 120v wall socket. Unit must be plugged in for the receiver to charge iPod or shuffle.

Optional: Connecting to an AV device (TV, VCR, etc.)

- a) The iH52 has 2 video out jacks, a standard yellow composite video jack and an S-video jack to output video signal from your 5G iPod with Video or iPod Photo to a VCR, TV monitor or similar device. Video cables are not provided. The video jacks do not output audio.

Optional: Connecting to a computer

- a) Use the USB cable included with your iPod to connect your docked iPod to a computer via the Sync Port on the rear of the Receiver. This can be used to sync your iPod with iTunes. During sync operation, your iPod will not be controlled by the iH52.

Setting the Clock

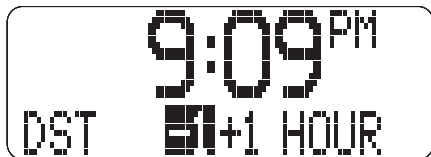

- a) To adjust for Daylight Saving Time (DST), press and hold the **dst/radio button**. The currently set time appears on the display with -1 and +1 below it. Press FORWARD or REVERSE to highlight the desired setting (the time will advance one hour or go back one hour, depending). Press the **dst/radio button**. Two beeps will indicate DST setting is complete.

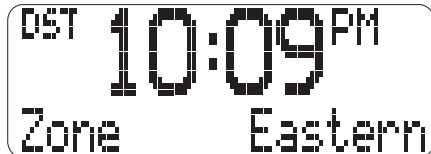

- b) To adjust the time zone, press and hold the Clock Button until the Time Zone display flashes. Unit is preset to Eastern Time; if needed, press FORWARD or REVERSE to cycle to your time zone.
- c) Press the Clock Button. The time display will flash. If the correct time is displayed, press the Clock Button again to confirm the time setting. If the correct time is not displayed, press FORWARD or REVERSE to adjust the time display (a PM indicator appears when time is set to PM). When the correct time is displayed, press the Clock Button again. Two beeps will indicate clock setting is complete.

Using your iPod

Playing and charging your iPod

- a) Insert proper dock insert for your iPod (see table on page 7), then gently dock iPod in **10** Dock. When docked, iPod will charge until fully charged when the iH52 is connected to an AC outlet. **Unit will not overcharge iPod.** If you dock an iPod that is in play mode, the iH52 will automatically switch to iPod mode and play your music.
- b) If iPod is not playing when docked, press the **Play/Pause Button** to play the iPod, and again to pause.
- c) Press the **8 9** Volume UP or DOWN buttons to adjust iH52 volume up or down. Use the Sub Level Knob on the subwoofer to adjust bass volume level.
- d) Press the EQ button to access the five EQ (tone) settings: flat, rock, jazz pop and R & B. Press the **FORWARD or REVERSE buttons** to cycle through the EQ settings.
- e) Press **1** Power On/Off Button to turn the iH52 and iPod off.

Using your iPod Shuffle

- a) To use your iPod shuffle, gently dock it in the Shuffle Dock. To listen to your iPod shuffle, press the **iPod Button** until "shuffle" and the shuffle icon appear in the display, then use controls on your shuffle. When docked, the shuffle will charge until fully charged when the iH52 is connected to an AC outlet. **Unit will not overcharge shuffle.**
- b) Adjust Volume and EQ settings as above to your listening preferences. To turn off shuffle, use shuffle controls.

Using the AM/FM Radio

- Make sure both the AM and FM antennas are properly attached and extended/located for best reception.
- Press the **Radio button**. By default, the FM band is selected, but the unit will revert to the last band in use (AM or FM). Press the **Radio button** to toggle between FM and AM bands.
- To tune a station**, press the **Select Down/REW** or **Select Up/FWD button** until the desired frequency appears (hold either button for faster selection; the unit will scan to the next station with clear reception).
- To save a station as a preset**, tune in the desired station then hold the desired preset button for about two seconds until you hear two confirmation beeps. You can save up to 12 presets (6 AM and 6 FM). To change a preset, follow the same steps for saving a preset.
- To listen to a preset station in radio mode**, press the **Radio button** to select the desired radio band (AM or FM), then press the desired preset button. The unit will tune to the preset station assigned in the selected band.

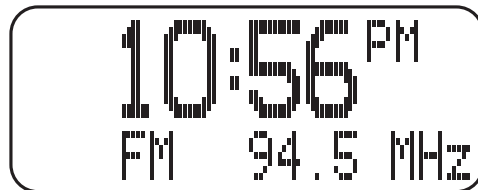

Using the Line-in Jack

- An audio patch cord comes with the iH52. Use it to play nondocking iPod models or other audio devices through the iH52 Line-in Jack (one end in the device's line out or headphones jack, the other in the iH52 line in jack). Press the **iPod Button** until AUX appears in the display. You can now play your device.

Using the Dimmer

- Press the **Dimmer Button** until "Dimmer" appears on the display. Hold the down/REW Button to dim the display brightness, or hold the up/FF Button to brighten the display. When the desired display brightness level is set, press the Dimmer button to return to normal display function.

Using the Display Control

- Press the **Display Button** to switch display modes on your docked iPod and on the iH52 display between standard and extended modes. In Extended mode, song information from your iPod appears on the iH52 display. The video out ports are disabled in this mode, as are iPod controls.

Replacing iH52 Backup Batteries

Install/Replace Backup Battery

The iH52 uses a backup battery system to provide continuous clock settings in the event of a power failure. If the Battery Low Icon located on the right of the display is flashing, it is time to replace the backup batteries. Please make sure the AC adaptor is connected, otherwise all settings may be lost during battery replacement.

- Open the battery compartment cover located on the bottom of the main receiver unit. Insert 3 "AA" batteries as indicated. We recommend the use of alkaline batteries for longer life.
- Please make sure the AC cord is connected; otherwise all settings may be lost during battery replacement.

Batteries information:

- Do not mix old and new batteries.
- Do not mix alkaline, standard (carbon -zinc) or rechargeable (nickel-cadmium) batteries.

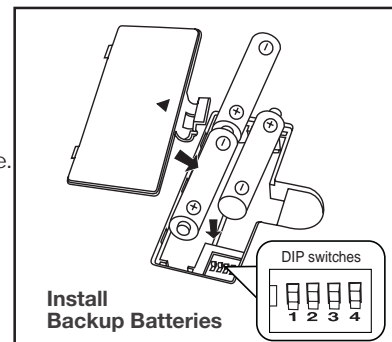

Install/Replace the Remote Control Batteries

The remote control batteries are already installed at the factory. When the remote control stops operating or its range seems reduced, replace the batteries with new ones.

1. The battery door is located on the back end of the unit.
2. Press to release the battery door latch.
3. Insert 2 "CR2032" 3-volt lithium batteries. Make sure the polarity (the + and - side of the battery) is correct.
4. Replace the battery holder back in the remote control.

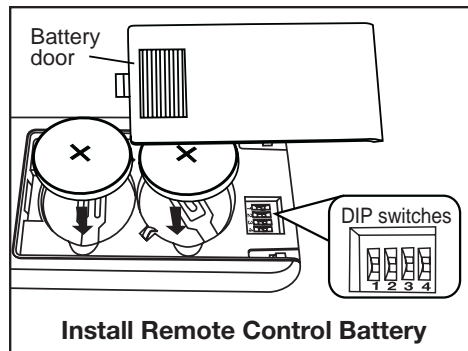

NOTE: PLEASE DISCARD BATTERIES PROPERLY

CHANGING THE REMOTE CONTROL CODE

The iH52 has 4 DIP switches located in the backup battery compartment (see page 11) and in the remote control battery compartment. If you experience interference from other remotes or have more than one iH52 operating at once, you may need to change the DIP switch settings (DIP settings on remote and base unit must always match). To do so:

- a) Open the battery compartment on both the remote control and the iH52.
- b) Check that all DIP switch positions on unit and remote control match
- c) Use fingernail or small object such as a paperclip tip to move ONE of the switches on the base unit to a different position. Do the same on the remote, making sure to move the same switch to the same position so the switches on each match.
- d) Test performance. If interference is still an issue, adjust DIP switch settings again.

OPERATING THE REMOTE CONTROL

The Remote Control controls basic functions on the iH52 and certain iPod® functions when the iPod® is docked in the iH52. For best results, aim remote control towards the receiver.

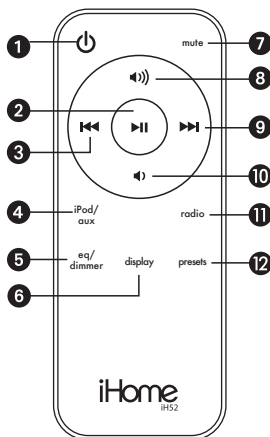

- 1 Power On/Off Button: Turns iH52 ON or OFF
- 2 Play/Pause Button : Plays track. In play mode, press to pause
- 3 Select Down/Rew Button: Skip to previous or next track when iPod is playing, or HOLD to scan current playing track
- 4 Aux/iPod/Shuffle Button: Select Aux, iPod or Shuffle mode
- 5 Settings Button: Selects EQ and dimmer settings
- 6 Display Button: Selects standard or extended display modes
- 7 Mute Button: Toggles sound ON or OFF
- 8 Volume + Button: Raises volume level
- 9 Select Up/FF Button: Skip to previous or next track when iPod is playing, or HOLD to scan current playing track.
- 10 Volume - Button: Lowers volume level
- 11 Radio Button: Play radio, select AM or FM band
- 12 Preset Button: Selects/sets up to six AM or FM station presets

Troubleshooting

Symptom	Possible Problem	Solution
Unit doesn't respond (no power)	Subwoofer power cord isn't plugged into a wall outlet	Plug the AC cord into a wall outlet
	Wall outlet is not functioning	Plug another device into the same outlet to confirm the outlet is working. Test any switches that may control the outlet
	Subwoofer is not connected to receiver	Make sure connector cable from subwoofer to receiver is connected properly
iPod does not dock properly	Using no or wrong iPod insert	Make sure the dock insert is the proper fit for your iPod
	iPod not installed properly	Remove your iPod from the dock and check for obstruction on the connectors in the dock and on your iPod. Then reseal it in the dock.
Battery Low icon always flashing	Batteries are weak	Replace with new batteries
	Batteries were not installed properly	Check to make sure the polarity (+ and – ends) matches the diagram in the battery compartment
iPod does not respond to the unit	iPod is not installed properly	Remove your iPod from the dock and check for obstruction on the connectors in the dock and on your iPod. Then reseal it in the dock.
	Your iPod software is too old	Upgrade software on your iPod. For details visit http://www.apple.com/ipod/download
	iPod is locked up	Please make sure your iPod is working properly before docking into the unit. Please refer to your iPod manual for details.
	Using 1 st or 2 nd generation iPod or other devices.	iH52 cannot control those iPods or other devices.
iPod does not come on immediately	If your iPod is not used for some time, it may enter deep sleep mode	
iPod backlight is out of control	Switching your iPod between standard and extended mode can affect the display	Power off the iPod then turn on again

Troubleshooting

Symptom	Possible Problem	Solution
iPod didn't charge up	iPod is not docked properly	Remove your iPod from the dock and check for obstruction on the connectors in the dock and on your iPod. Then reseat it in the dock.
	iPod is locked up/ frozen	Please make sure your iPod is working properly before docking into the unit. Please refer to your iPod manual for details.
	iPod battery has problem	
Sound is distorted	Volume level is set too high	Decrease the volume on both subwoofer and receiver
	Sound source is distorted	If the iPod original sound source (MP3) is of poor quality, distortion and noise are easily noticed with high-power speakers. Try a different audio source such as a music CD.
		If you are using an external sound source like older generation of iPod or other audio device, try reducing the output volume on the device itself.
		Try adjusting EQ settings on your iPod/iH52/sound source.
Remote Control didn't work	Remote Control is out of range	Move closer to unit
	Remote control battery is dead/weak	Replace current battery with new battery
	Interference from similar device on same channel	Change DIP settings, making sure DIP switches located in remote battery compartment match those in receiver battery compartment

Solucionando problemas

Síntoma	Causa	Solución
La unidad no funciona (no circula corriente eléctrica)	El adaptador de AC no está conectado al tomacorriente o el conector no está conectado a la ficha en la parte posterior de la unidad	Conecte el adaptador de AC al tomacorriente y también conecte el conector a la ficha en la parte posterior de la unidad
	El tomacorriente no funciona	Coloque otro aparato en ese mismo tomacorriente para confirmar si el que no funciona es el tomacorriente
	Las baterías están gastadas	Reemplace las baterías
El iPod no encastra correctamente	No ha colocado el encastre del iPod, o está utilizando el encastre incorrecto.	Verifique que el encastre sea el apropiado para su iPod
	El iPod no encastra correctamente	Quite el iPod del encastre y retire la posible obstrucción del encastre o de su iPod. Vuelva a colocar el iPod dentro del encastre.
El ícono de batería baja está destellando	Las baterías están gastadas	Reemplace las baterías
	Las baterías no están instaladas correctamente	Verifique que la polaridad de las baterías (- y +) se encuentren de acuerdo al diagrama del compartimiento de baterías.
El iPod no se comunica con la unidad	El iPod no está instalado correctamente	Quite el iPod del encastre y verifique posibles obstrucciones del encastre o de su iPod. Vuelva a colocar el iPod dentro del encastre.
	Su software es obsoleto	Renueve su software. Para mayor información, diríjase a http://www.apple.com/ipod/download
	El iPod no responde	Verifique que su iPod funcione correctamente antes de conectarlo a la unidad. Refiérase al manual de su iPod para más detalles.
	Usted tiene un iPod de primera o segunda generación, un Shuffle u otro tipo de aparato	El iH25 no puede controlar estos otros aparatos

Solucionando problemas

Síntoma	Causa	Solución
El iPod no carga	El iPod no está instalado correctamente	Quite el iPod del encastre y retire la posible obstrucción del encastre o de su iPod. Vuelva a colocar el iPod dentro del encastre.
	El iPod está trabado/no responde	Por favor asegúrese de que su iPod funcione correctamente antes de colocarlo en el encastre. Refiérase al manual de su iPod para mayor información.
	La batería del iPod podría tener algún inconveniente	
El sonido sale distorsionado	El volumen se encuentra muy alto	Baje el volumen
	El sonido sale distorsionado de la unidad	Si el sonido original de su iPod era de pobre calidad, las distorsiones y ruidos se harán más notables con los parlantes de alta potencia. Pruebe utilizar otra fuente de audio como un CD. Si está utilizando un iPod de primeras generaciones o un Shuffle, intente bajar el volumen de su aparato. También intente apagar el amplificador de bajos
El control remoto no funciona	Las baterías están gastadas	Reemplace las baterías por nuevas

Limited 90-Day Warranty Information

iHome Products, a division of SDI Technologies Inc. (hereafter referred to as SDI Technologies), warrants this product to be free from defects in workmanship and materials, under normal use and conditions, for a period of 90 days from the date of original purchase.

Should this product fail to function in a satisfactory manner, it is best to first return it to the store where it was originally purchased. Should this fail to resolve the matter and service still be required by reason of any defect or malfunction during the warranty period, SDI Technologies will repair or, at its discretion, replace this product without charge (except for a \$10.00 charge for handling, packing, return UPS/postage, and insurance). This decision is subject to verification of the defect or malfunction upon delivery of this product to the Factory Service Center listed below. The product must include proof of purchase, including date of purchase. The fee for service without proof of purchase is \$30.00.

Before returning this product for service, please first replace the batteries (if applicable) with fresh ones, as exhausted or defective batteries are the most common cause of problems encountered.

If service is still required:

1. Remove the batteries (if applicable) and pack the unit in a well padded, heavy corrugated box.
2. Enclose a photocopy of your sales receipt, credit card statement, or other proof of the date of purchase, if within the warranty period.
3. Enclose a check or money order payable to the order of SDI Technologies, for the sum of \$10.00 (\$30.00 without proof of purchase).
4. Send the unit prepaid and insured, to the Factory Service Center listed below.

Consumer Repair Department
SDI Technologies Inc.
1330 Goodyear Drive
El Paso, TX 79936-6420

Disclaimer of Warranty

NOTE: This warranty is valid only if the product is used for the purpose for which it was designed. It does not cover (i) products which have been damaged by negligence or willful actions, misuse or accident, or which have been modified or repaired by unauthorized persons; (ii) cracked or broken cabinets, or units damaged by excessive heat; (iii) damage to digital media players, CD's or tape cassettes (if applicable); (iv) the cost of shipping this product to the Factory Service Center and its return to the owner.

This warranty is valid only in the United States of America and does not extend to owners of the product other than to the original purchaser. In no event will SDI Technologies or any of its affiliates, contractors, resellers, their officers, directors, shareholders, members or agents be liable to you or any third party for any consequential or incidental damages, any lost profits, actual, exemplary or punitive damages. (Some states do not allow limitations on implied warranties or exclusion of consequential damages, so these restrictions may not apply to you.) This warranty gives you specific legal rights, and you may also have other rights which vary from state to state. Your acknowledgment and agreement to fully and completely abide by the above mentioned disclaimer of warranty is contractually binding to you upon your transfer of currency (money order, cashier's check, or credit card) for purchase of your SDI Technologies product.

**Questions? Visit www.ihomeaudio.com
or call 1-800-288-2792 Toll Free**

Free Manuals Download Website

<http://myh66.com>

<http://usermanuals.us>

<http://www.somanuals.com>

<http://www.4manuals.cc>

<http://www.manual-lib.com>

<http://www.404manual.com>

<http://www.luxmanual.com>

<http://aubethermostatmanual.com>

Golf course search by state

<http://golfingnear.com>

Email search by domain

<http://emailbydomain.com>

Auto manuals search

<http://auto.somanuals.com>

TV manuals search

<http://tv.somanuals.com>