



Models:
PCFM-HNG
PCFML-HNG
Patio Campfire
Decorative Gas Log Set



	<p>CAUTION</p> <p>DO NOT DISCARD THIS MANUAL</p>	
<ul style="list-style-type: none"> • Important operating and maintenance instructions included. 	<ul style="list-style-type: none"> • Read, understand and follow these instructions for safe installation and operation. 	<ul style="list-style-type: none"> • Leave this manual with party responsible for use and operation.

⚠ WARNING



If the information in these instructions is not followed exactly, a fire may result causing property damage, personal injury, or death.

- Do not store or use gasoline or other flammable vapors and liquids in the vicinity of this or any other appliance.
- **What to do if you smell gas:**
 - Do not try to light any appliance.
 - Do not touch any electrical switch. Do not use any phone in your building.
 - Immediately call your gas supplier from a neighbor's phone. Follow the gas supplier's instructions.
 - If you cannot reach your gas supplier, call the fire department.
- Installation and service must be performed by a qualified installer, service agency, or the gas supplier.



⚠ WARNING



HOT! DO NOT TOUCH. SEVERE BURNS MAY RESULT. CLOTHING IGNITION MAY RESULT.

Glass and other surfaces are hot during operation and cool down.

- Keep children away.
- **CAREFULLY SUPERVISE** children in same room as appliance.
- Alert children and adults to hazards of high temperatures.
- Keep clothing, furniture, draperies and other combustibles away.

	<p>Installation and service of this appliance should be performed by qualified personnel. Hearth & Home Technologies suggests NFI certified or factory-trained professionals, or technicians supervised by an NFI certified professional.</p>	
---	---	---

**Read this manual before installing or operating this appliance.
Please retain this owner's manual for future reference.**

Congratulations

Congratulations on selecting a Heat & Glo LifeStyle Collection decorative gas log set. The Patio Campfire you have selected is designed to provide the utmost in safety, reliability, and efficiency.

As the owner of a Patio Campfire, you'll want to read and carefully follow all of the instructions contained in this owner's manual. Pay special attention to all cautions and warnings.

This owner's manual should be retained for future reference. We suggest you keep it with your other important documents and product manuals.

The information contained in this owner's manual, unless noted otherwise, applies to all models and gas control systems.

Your new Patio Campfire will give you years of durable use and trouble-free enjoyment. Welcome to the Heat & Glo LifeStyle Collection family of appliance products!

<p>Homeowner Reference Information</p> <p>Model Name: _____ Date purchased/installed: _____</p> <p>Serial Number: _____ Location on appliance: _____</p> <p>Dealership purchased from: _____ Dealer phone: _____</p> <p>Notes: _____</p> <p>_____</p> <p>_____</p>	<p><i>We recommend that you record the following pertinent information about your appliance:</i></p>
---	--

Listing Label Information/Location

The model information regarding your specific appliance can be found on the rating plate located in the control area of the appliance.

	<p>LISTED OUTDOOR GAS FIREPLACE 22UM</p>	<p>Hearth & Home Technologies Inc. 20802 Kensington Blvd. Lakeville, MN 55044</p>
<p>Model/ Modele PCFM-HNG IAS U.S. 4-96 OUTDOOR GAS FIREPLACE For Canada Z21.58-1995/CGA 1.6-M95 Type of Gas: Natural Gas Sorte De Gaz: Naturel</p>	<p>Altitude: Input: 0-2000 ft. 75,000 BTUH (22.0 kW)</p>	<p>MFG. DATE DATE DE FAB. 2000-4500 ft. (in Canada) 67,500 BTUH (19.8 kW)</p>
<p>Min. Gas supply for Input Adj. / Alimentation en gaz min. pour réglage de la puissance: Max. Gas Supply / Alimentation en gaz max: Manifold Pressure / Puissance de pression d'admission de:</p>	<p>Orifice Size: #27 DMS</p> <p>7.0 in. w.c. (17 kPa) 14.0 in. w.c. (3.5 kPa) 3.5 in. w.c. (.87 kPa)</p>	<p>Serial/Serie OP #28 DMS</p>
<p>WARNING: Must Not Be Used For Cooking. WARNING: For Outdoor Use Only.</p>	<p>AVERTISSEMENT: Ne pas utiliser pour la cuisson. AVERTISSEMENT: Pour utilisation à l'extérieur seulement.</p>	
<p>MINIMUM CLEARANCES: Bottom: 0 inch Top: 8 Ft. (2.4m) Minimum clearance from sides and back of unit to adjacent combustible construction below top of unit, 24 inches from sides and 24 inches from back. Minimum horizontal clearance from sides and back of unit to adjacent vertical combustible construction extending above top of unit, 24 inches from sides and 24 inches from back.</p>	<p>DEGAGEMENT MINIMAL: Dessous: 0mm Supérieure: 2.4m Dégagement minimal à respecter entre les côtés et l'arrière de l'appareil et une construction combustible adjacente située au-dessous de la partie supérieure de l'appareil, soit 24 pouces des côtés et 24 pouces de l'arrière. Dégagement horizontal minimal à respecter entre les côtés et l'arrière de l'appareil et une construction combustible verticale adjacente dépassant la partie supérieure de l'appareil, soit 24 pouces des côtés et 24 pouces de l'arrière.</p>	
<p>This appliance must be installed in accordance with local codes, if any. If none, follow ANSI Z223.1 or CAN/CGA-B149, installation codes. Cef appareil doit être installé conformément aux exigences des codes locaux. S'il n'existe aucun code local, consulter la norme CAN/CGA B149.</p>		<p>MADE IN: XXXX</p>
<p><small>This product is covered by one or more of the following patents: (United States) 4,112,913; 4,408,594; 4,422,426; 4,424,792; 4,520,791; 4,793,322; 4,852,548; 4,875,464; 5,000,162; 5,016,609; 5,076,254; 5,191,877; 5,218,953; 5,328,356; 5,429,495; 5,452,708; 5,542,407; 5,613,487; (Australia) 543790; 586383; (Canada) 1,123,296; 1,297,746; 2,195,264; (Mexico) 97-0457; (New Zealand) 200265; or other U.S. and foreign patents pending.</small></p>		

Table of Contents

1 Listing and Code Approvals	4
A. Appliance Certification	4
B. BTU Specifications	4
C. High Altitude Installations	4
2 Getting Started	5
A. Design and Installation Considerations	5
B. Tools and Supplies Needed	5
C. Inspect the Appliance and Components	6
3 Framing and Clearances	7
A. Select Appliance Location	7
B. Clearances	7
4 Gas Information	8
A. Fuel	8
B. Gas Pressure	8
C. Gas Connection	8
D. High Altitude Installations	9
5 Finishing	9
E. LP Gas Supply	9
6 Appliance Setup	10
A. Burner Assembly	10
B. Log Assembly	11
7 Operating Instructions	12
A. Before Lighting Appliance	12
B. Lighting the Appliance	13
C. After the Appliance is Lit	14
D. Frequently Asked Questions	14
8 Troubleshooting	14
9 Maintaining and Servicing the Appliance	15
10 Reference Materials	17
A. Limited Lifetime Warranty	17
B. Contact Information	18

1 Listing and Code Approvals

A. Appliance Certification

MODELS: PCFM-HNG, PCFML-HNG
LABORATORY: Underwriters Laboratories, Inc. (UL)
TYPE: Decorative Gas Log Set
STANDARD: **IAS US requirements for Outdoor Gas Fireplaces, Draft 4-96 and ANSI Z21.58-1995/CGA 1.6 M96**

The Patio Campfire has been tested in accordance with **IAS US requirements for Outdoor Gas Fireplaces, Draft 4-96 and ANSI Z21.58-1995/CGA 1.6-M96** for Canada and has been listed by Underwriters Laboratory (UL) for installation and operation as described in these installation and operating instructions.

The installation must conform with local codes or, in the absence of local codes, with the **National Fuel Gas Code ANSI Z223.1** or **CAN/CGA-B149.1, National Gas Installation Code** or **CAN/CGA-B149.2, Propane Installation Code**.

B. BTU Specifications

Model	Max Input BTUH	Orifice Size
PCFM-HNG	75,000	#27/.144
PCFML-HNG	60,000	#44/.086

C. High Altitude Installations

U.L. Listed gas appliances are tested and approved without requiring changes for elevations from 0 to 2000 feet in the U.S.A. and Canada.

When installing this appliance at an elevation above 2000 ft, it may be necessary to decrease the input rating by changing the existing burner orifice to a smaller size. Input rate should be reduced by 4% for each 1000 ft above a 2000 ft elevation in the U.S.A., or 10% for elevations between 2000 and 4500 ft in Canada. If the heating value of the gas has been reduced, these rules do not apply. To identify the proper orifice size, check with the local gas utility.

If installing this appliance at an elevation above 4500 ft (in Canada), check with local authorities.

2 Getting Started

This appliance is a Decorative Gas Log Set for **OUTDOOR USE ONLY** and **MUST NOT** be used for cooking.

Place the MESA Ring on a flat and stable surface in an outdoor location such as a patio or deck. This location must be adjacent to the gas supply line or LP gas supply cylinder. **DO NOT locate the MESA Ring where it can get excessively wet or submerged in water. Place the burner inside the MESA Ring as shown below.**

A. Design and Installation Considerations

When planning an appliance installation, it's necessary to determine the following information before installing:

- Where the appliance is to be installed. **See Sections 3 and 4.**
- Gas supply piping. **See Section 5.**
- Framing and finishing details. **See Sections 3 and 4.**

B. Tools and Supplies Needed

Before beginning the installation be sure that the following tools and building supplies are available.

- Gloves
- Safety glasses
- Flat blade screwdriver
- Non-corrosive leak check solution
- Wrenches



⚠ WARNING

Hearth & Home Technologies disclaims any responsibility for, and the warranty will be voided by, the following actions:

- Installation and use of any damaged components.
- Modification of the burner or log assemblies.
- Installation other than as instructed by Hearth & Home Technologies.
- Improper positioning of the gas logs.
- Installation and/or use of any component part not approved by Hearth & Home Technologies.

Any such action may cause a fire hazard.

⚠ WARNING

Do **NOT** use this appliance if any part has been under water. Immediately call a qualified service technician to inspect the appliance and to replace any part of the control system and any gas control which has been under water.

CAUTION

- Check building codes prior to installation.
- Installation **MUST** comply with local, regional, state and national codes and regulations.
 - Consult insurance carrier, local building, fire officials or authorities having jurisdiction about restrictions, installation inspection, and permits.

⚠ WARNING



Asphyxiation Risk

- This gas log set is for outdoor use in a well-ventilated space.
- Log set must not be installed inside an enclosed structure or unvented appliance.

CAUTION





Sharp Edges

- Wear protective gloves and safety glasses during installation.



C. Inspect the Appliance and Components

	WARNING Inspect appliance and components for damage. Damaged parts may impair safe operation.
	<ul style="list-style-type: none">• Do NOT install damaged components.• Do NOT install incomplete components.• Do NOT install substitute components. Report damaged parts to dealer.

- Carefully remove the appliance and components from the packaging
- The gas logs may be packaged separately and must be field installed.
- Report to your dealer any parts damaged in shipment.
- **Read all of the instructions before starting the installation. Follow these instructions carefully during the installation to ensure maximum safety and benefit.**

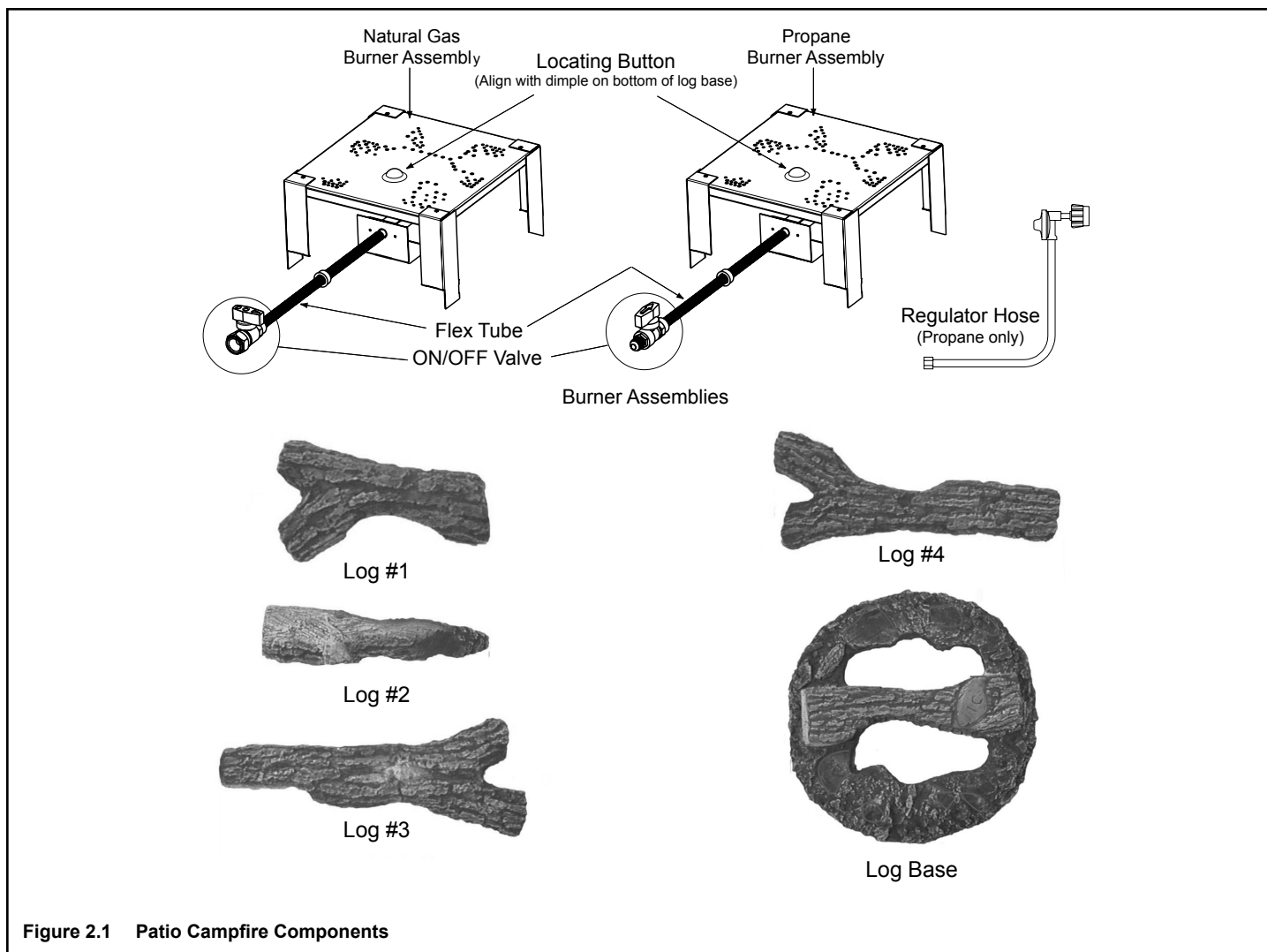

Figure 2.1 Patio Campfire Components

3 Framing and Clearances

Note:

- Illustrations reflect typical installations and are FOR DESIGN PURPOSES ONLY.
- Illustrations/diagrams are not drawn to scale.
- Actual installation may vary due to individual design preference.



⚠ WARNING

Fire Risk

Provide adequate clearance:

- Around air openings.
- For service access.

Locate appliance away from traffic areas.

A. Select Appliance Location

When selecting a location for your appliance it is important to consider the required clearances to walls (See Figure 3.1).

B. Clearances

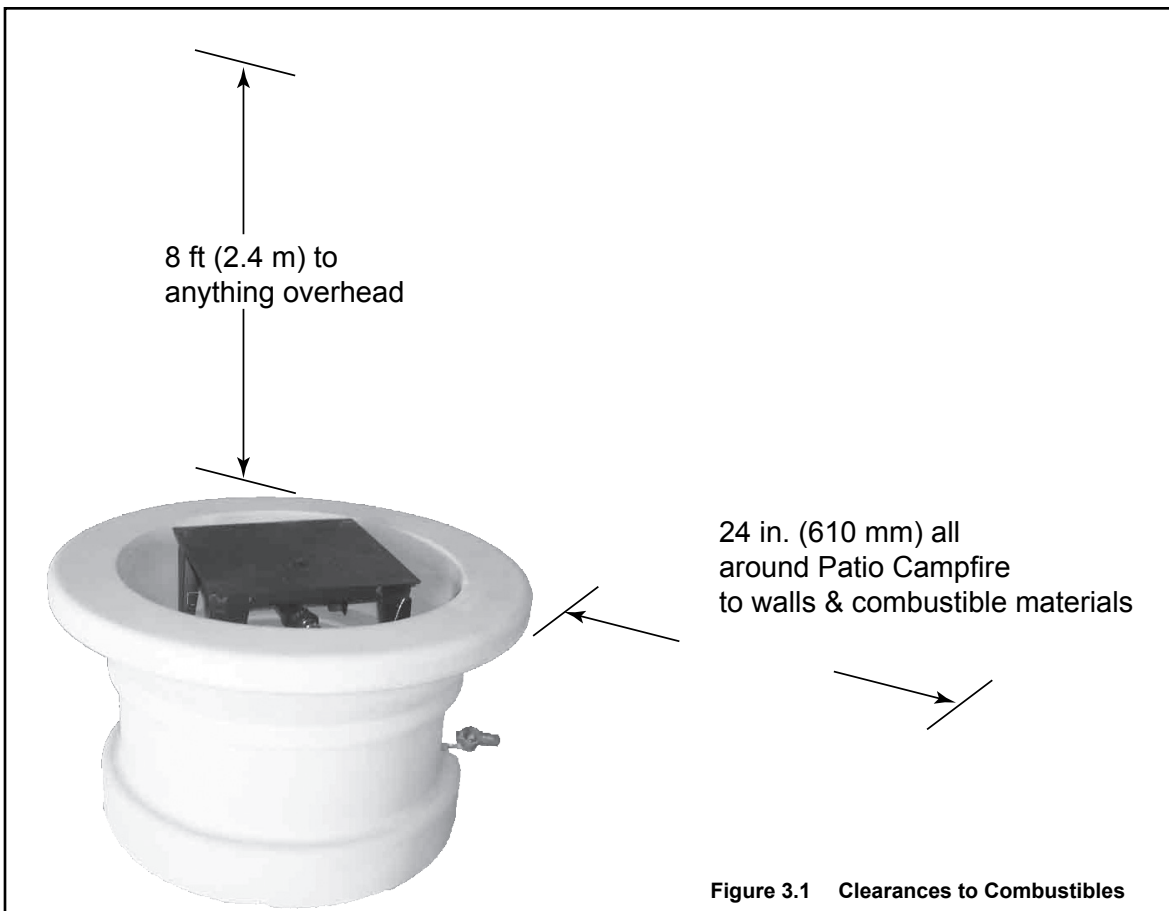

Figure 3.1 Clearances to Combustibles

4 Gas Information



A. Fuel

Before making gas connections ensure appliance being installed is compatible with the available gas type.

B. Gas Pressure

Proper input pressures are required for optimum appliance performance. Gas line sizing requirements need to be made following **NFPA51**.

 **WARNING**

Fire Risk
Explosion Risk

Verify inlet pressures.

- High pressure may cause overfire condition.
- Low pressure may cause explosion.
- Verify minimum pressures when other household gas appliances are operating.

Install regulator upstream of valve if line pressure is greater than 1/2 psig.

Pressure requirements for appliance are shown in table below. Minimum pressures must be met when other household gas appliances are operating.

Pressure	Natural Gas	Propane
Minimum Inlet Pressure	5.0 in. w.c.	11.0 in. w.c.
Maximum Inlet Pressure	7.0 in. w.c.	14.0 in. w.c.

C. Gas Connection



Note: Have the gas supply line installed in accordance with local building codes, if any. If not, follow **ANSI 223.1**. Installation should be done by a qualified installer approved and/or licensed as required by the locality. (In the Commonwealth of Massachusetts installation must be performed by a licensed plumber or gas fitter.)

Note: A listed (and Commonwealth of Massachusetts approved) 1/2 in. (13 mm) T-handle manual shut-off valve and flexible gas connector are connected to the 1/2 in. (13 mm) control valve inlet.

- **If substituting for these components, please consult local codes for compliance.**

- Incoming gas line should be piped to the 1/2 in. connection on the manual shutoff valve.

 **WARNING**







Fire Risk
Explosion Risk

- Gas build-up during line purge may ignite.
- Purge should be performed by qualified technician.
- Ensure adequate ventilation.
- Ensure there are no ignition sources such as sparks or open flames.

- A small amount of air will be in the gas supply lines. When first lighting appliance it will take a short time for air to purge from lines. Subsequent lighting of the log set will not require such purging. **Never allow the ON/OFF valve to remain in the open position without placing a burning match on top of the burner FIRST.**

 **WARNING**

CHECK FOR GAS LEAKS
Fire Risk
Explosion Risk
Asphyxiation Risk

- Check all fittings and connections.
- Do not use open flame.
- After the gas line installation is complete, all connections must be tightened and checked for leaks with a commercially available, non-corrosive leak check solution. Be sure to rinse off all leak check solution following testing.

Fittings and connections may have loosened during shipping and handling.

D. High Altitude Installations

U.L. listed gas appliances are tested and approved without requiring changes for elevations from 0 to 2000 ft in the USA and Canada.

When installing this appliance at an elevation above 2000 ft, it may be necessary to decrease the input rating by changing the existing burner orifice to a smaller size. Input rate should be reduced by 4% for each 1000 ft above a 2000 ft elevation in the U.S.A., or 10% for elevations between 2000 and 4500 ft in Canada. If the heating value of the gas has been reduced, these rules do not apply. To identify the proper orifice size, check with the local gas utility.

If installing this appliance at an elevation above 4500 ft (in Canada), check with local authorities.

E. LP Gas Supply

- The pressure regulator and hose assembly supplied with LP models must be used. Replacement pressure regulators and hose assemblies must be those specified in this manual.
- The LP gas supply cylinder used with LP models must be constructed and marked in accordance with the specifications for LP gas cylinders of the U.S. Department of Transportation (DOT).
- Cylinders must be stored outdoors in a well ventilated area out of the reach of children. Disconnected cylinders must have threaded valve plugs tightly installed and must not be stored in a building, garage or any other enclosed area.
- Storage of this appliance indoors is permissible only if it has been disconnected from its fuel supply (natural gas line or LP gas cylinder).
- The LP gas cylinder supply system must be arranged for vapor withdrawal.
- The LP gas cylinder used must include a collar to protect the cylinder valve.
- When an LP model is not in use, the LP gas must be turned off at the supply cylinder.

5 Finishing

This decorative gas log set must be used in the Mesa Decorative Surround.



Figure 5.1 Mesa

6 Appliance Setup

A. Burner Assembly

All Models

- Remove the burner assembly and check for damage. Do not use damaged components.
- Position the burner assembly in the desired location. This location must be adjacent to the gas supply line. You must have easy access to the gas valve control knob after it is installed and connected to the gas supply because the ON/OFF gas valve is used to turn the burner on and off.

Natural Gas Models

- Connect the ON/OFF gas valve of the appliance to the incoming gas supply line. See Figure 6.1. Make certain all gas connections are tight.
- Turn the ON/OFF valve at the appliance slowly to the "ON" position. All connections must be tightened and checked for leaks with a commercially available, non-corrosive leak check solution. Be sure to rinse off the solution when done leak testing.

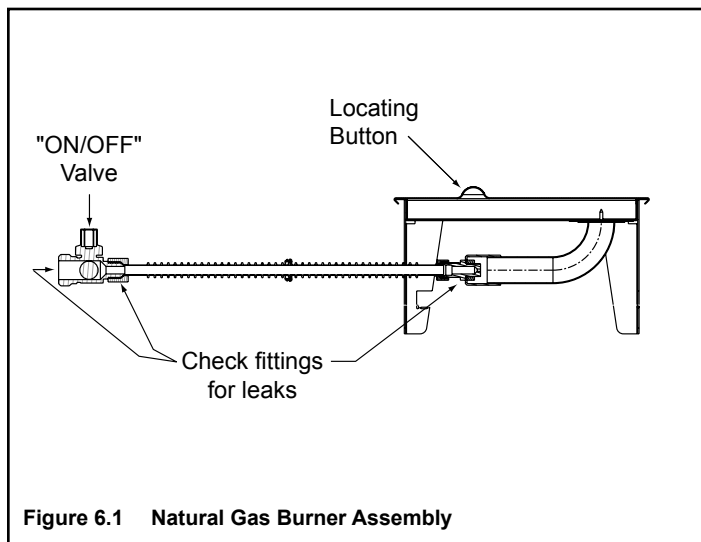

LP Gas Models

- Make sure the tank valve is turned completely off (clockwise).
- Ensure the tank valve has the proper external mating threads (tank valve marked "USE WITH TYPE 1").
- Inspect the hose shipped with the appliance for any damage. Do not use if there is evidence of damage.
- Connect the end of the hose onto the ON/OFF gas valve of the appliance. Make sure it is secured tightly.
- Connect the regulator assembly to the tank valve. Hand tighten only (clockwise). Do not use a wrench to tighten! Use of a wrench may damage the quick closing nut and result in a hazardous condition. See Figure 6.2.
- Position the hose out of pathways where people might trip over it or in areas where the hose might be subject to accidental damage.
- Open the tank valve fully (counterclockwise). Turn the ON/OFF valve slowly to the "ON" position. All connections must be tightened and checked for leaks with a commercially available, non-corrosive leak check solution. Be sure to rinse off the solution when done leak testing. If a leak is found, turn the tank valve off and do not use the appliance until repairs can be made.

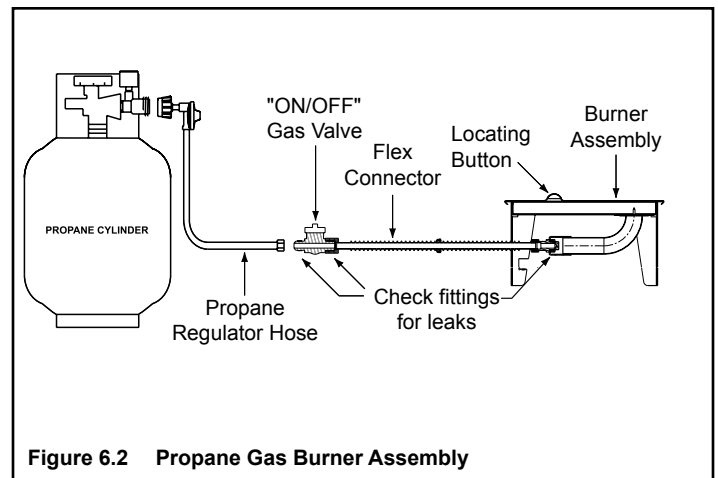

B. Log Assembly

- Check all logs and log base for damage. Do not use damaged or broken components!
- Position the log base over the burner making sure to align the dimple in the log base over the locating button on the burner top (see Figure 2.1 for locating button).
- Position the logs by placing the corresponding letter/number combinations located on the logs (Figure 6.3) with those on the log base (Figure 6.4). See Figure 6.5 for completed log assembly.

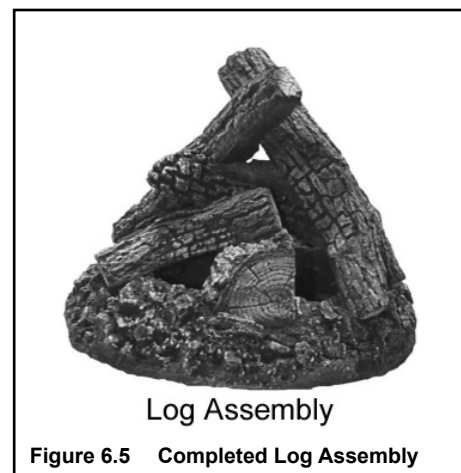
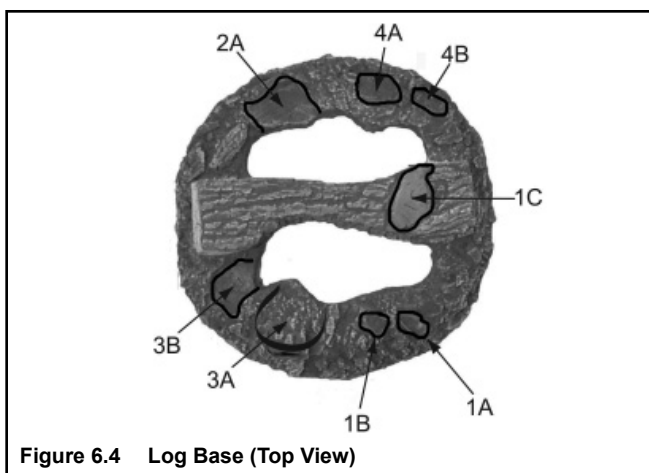
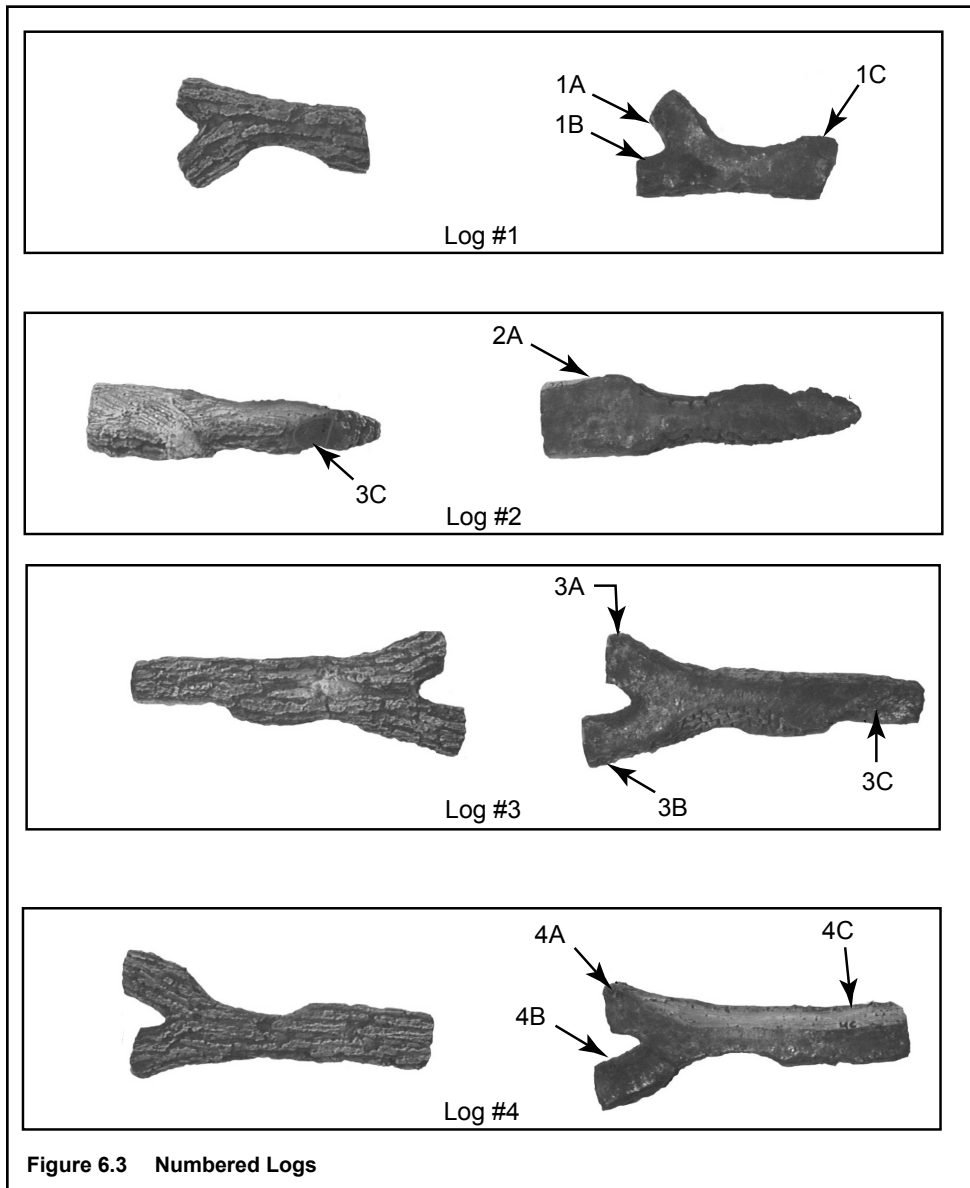

7 Operating Instructions

A. Before Lighting Appliance

LP (Propane)

- Before lighting this appliance, ensure both the LP tank valve and the manual shutoff valve are closed. Open the LP tank valve first, THEN the manual shutoff valve. This is required due to built-in safety features of your LP tank.

Natural Gas

- Before lighting this appliance, ensure the manual shutoff valve is open.

Before operating this appliance, have a qualified technician:

- Inspect the burner before each use of the gas log set. If there is any evidence that the burner is damaged, it must be replaced before operating.
- Review proper placement of logs.
- Check the air shutter adjustment.
- Ensure that there are no gas leaks.
- Ensure that the flow of combustion and ventilation air is not obstructed.

WARNING

Improper installation, adjustment, alteration, service or maintenance can cause injury or property damage. Refer to the owner's information manual provided with this appliance. For assistance or additional information consult a qualified installer, service agency or the gas supplier.

WARNING

Do NOT use this appliance if any part has been under water. Immediately call a qualified service technician to inspect the appliance and to replace any part of the control system and any gas control which has been under water.

WARNING



Fire Risk

Burn Risk

HOT! DO NOT TOUCH.

SEVERE BURNS MAY RESULT.

CLOTHING IGNITION MAY RESULT

Glass and other surfaces are hot during operation and cool down.

- Keep children away.
- CAREFULLY SUPERVISE children in same room as appliance.
- Alert children and adults to hazards of high temperatures.
- Keep clothing, furniture, draperies and other combustibles away.

B. Lighting the Appliance

FOR YOUR SAFETY, READ BEFORE LIGHTING

WARNING!

If you do not follow these instructions exactly, a fire or explosion may result causing property damage, personal injury and/or loss of life.

- A.** This appliance must be lit by hand. When lighting, follow these instructions exactly.
- B. Before lighting**, smell all around the appliance area for gas. Be sure to smell next to the base of the appliance because some gas is heavier than air and will settle on the floor.
- WHAT TO DO IF YOU SMELL GAS:**
- Do not try to light any appliance.
 - Do not touch any electric switch; do not use any phone in your building.
 - Immediately call your gas supplier from a neighbor's phone. Follow the gas supplier's instructions.
 - If you cannot reach your gas supplier, call the fire department.
- C.** Use only your hand to turn the gas control knob or valve. Never use tools. If the valve will not turn by hand, don't try to repair it, call a qualified service technician. Force or attempted repair may result in a fire or explosion.
- D.** Do not use the appliance if any part has been under water. Immediately call a qualified service technician to inspect the appliance, and to replace any part which has been under water.

LIGHTING INSTRUCTIONS

1. **Stop!** Read the safety information above.
2. Remove the cover.
3. Find the manual gas control valve.
4. Place a burning match on top of the burner in the middle where ports are present. **DO NOT HOLD THE MATCH IN YOUR HAND!** For a natural gas appliance turn on the ON/OFF valve slowly at the appliance. For an LP appliance turn the valve on the LP tank counterclockwise all the way and then turn on the ON/OFF valve slowly at the appliance.
5. If the burner does not light before the match goes out, immediately turn the gas valve to "OFF".
6. Wait at least five minutes to clear out any gas. Then smell for gas, including the base of the appliance. If you smell gas, **STOP!** Follow "B" in the safety information above. If you do not smell gas, repeat Step 4.

TO TURN OFF GAS TO APPLIANCE

Turn the ON/OFF valve to the "OFF" position at the appliance for a natural gas appliance.

For an LP appliance, turn the ON/OFF valve to the "OFF" position at the appliance and then turn the valve on the LP tank clockwise to the "OFF" position.

C. After the Appliance is Lit

Initial Break-in Procedure

When you light the appliance, you may notice that it produces heat which may have an odor or smell. If you feel this odor is excessive it may require the initial three to four hour continuous burn followed by a second burn up to 12 hours to fully drive off any odor from paint and lubricants used in the manufacturing process.

Note: This appliance should be run three to four hours on the initial start-up. Turn it off and let it cool completely. This will help cure the products used in the paint and logs.



WARNING

Fire Risk

Keep combustible materials, gasoline and other flammable vapors and liquids clear of appliance.

- Do NOT store flammable materials in the vicinity of the appliance.
- Do NOT use gasoline, lantern fuel, kerosene, charcoal lighter fluid or similar liquids in this appliance.

Combustible materials may ignite.



WARNING

Fire Risk

High Temperatures

Keep combustible household items away from appliance.

- Do NOT obstruct combustion and ventilation air.
- Do NOT place combustible items on top of or near appliance.
- Keep furniture, draperies away from appliance.

D. Frequently Asked Questions

Issue	Solutions
Blue flames	This is a result of normal operation and the flames will begin to yellow as the log set is allowed to burn for 20 to 40 minutes.
Odor from log set	When first operated, this log set may release an odor for the first several hours. This is caused by the curing of the paint and burning off of any oils remaining from manufacturing.
Metallic noise	Noise is caused by metal expanding and contracting as it heats up and cools down, similar to the sound produced by a furnace or heating duct. This noise does not affect the operation or longevity of the Patio Campfire.

8 Troubleshooting





With proper installation, operation and maintenance your Patio Campfire will provide years of trouble-free service. If you do experience a problem, this troubleshooting guide will assist a qualified service person in the diagnosis of a problem and the corrective action to be taken. This troubleshooting guide can only be used by a qualified service technician.

Symptom		Possible Causes		Corrective Actions.
1	Decorative gas log set won't light.	A.	No LP in tank.	Check the LP (propane) tank. You may be out of gas.
		B.	Plugged burner orifice	Check the burner orifice for stoppage. Remove stoppage.
2	Low flames or won't stay lit.	A.	Manual shutoff valve open or not installed between LP tank and log set.	Close LP tank and manual shutoff valves. Open LP tank valve first, THEN the manual shutoff valve.

9 Maintaining and Servicing the Appliance

Although the frequency of appliance servicing and maintenance will depend on use and the type of installation, a qualified service technician should perform an appliance check-up annually.

 WARNING
Risk of injury or property damage
Before servicing:
<ul style="list-style-type: none"> • Turn off utilities to appliance. • Ensure appliance is completely cooled.

 WARNING	
	Annual inspection by qualified technician recommended.
	Check:
	<ul style="list-style-type: none"> • Obstructions of combustion and ventilation air. • Condition of logs. • Condition of burner assembly. • Burner ignition and operation. • Burner air shutter adjustment. • Gas connections and fittings.
	Risk of:
	<ul style="list-style-type: none"> • Fire • Delayed ignition or explosion • Exposure to combustion fumes • Odors

Maintenance and Service Tasks:

Inspect	Maintenance Tasks	
Burner Assembly	1	Remove logs and examine burner. Vacuum and wipe out dust, cobwebs, debris or pet hair. Use caution when cleaning these areas. Screw tips that have penetrated the sheet metal are sharp and should be avoided.
	2	Remove any foreign objects
	3	Inspect for paint condition, warpage, corrosion. Sand and repaint as necessary.
	4	Check the hose connecting the LP gas cylinder to ensure it is not damaged. Replace as necessary.
	5	Verify unobstructed air circulation.
Logs	1	Inspect for broken, damaged or missing logs. Replace as necessary.
	2	Verify correct log placement and no flame impingement causing sooting. Correct as necessary.
	3	Verify logs are clean and carbon (soot) free. Logs may be cleaned with a dry bristle brush or dry cloth. Handle logs with care as they are fragile and easily damaged.
Burner ignition and operation	1	Verify all gas connections are tight and leak-free.
	2	Clean off burner top, inspect for plugged ports, corrosion or deterioration. Replace burner if necessary.
	3	Check for smooth lighting and ignition carryover to all ports. Verify there is no ignition delay.
	4	Inspect for lifting or other flame problems.
	5	Verify air shutter is clear of dust and debris.
	6	Inspect orifice for soot, dirt or corrosion.
	7	Verify manifold and inlet pressures. Adjust regulator as required.
Regulator and Hose-LP Model	1	Clean regulator and hose with ?? and soapy water. Check for leaks, cracks, cuts or ??. Replace with 4004-014 Regulator & Hose Kit if needed.

This page intentionally left blank.

10 Reference Materials

A. Limited Lifetime Warranty

HEAT & GLO

LifeStyleCollection™

Hearth & Home Technologies Inc.

Outdoor Products Limited One Year Warranty

Hearth & Home Technologies Inc. extends the following warranty for Hearth & Home Technologies outdoor products used in the United States of America or Canada. Dealers and employees of Hearth & Home Technologies have no authority to make any warranty or authorize any remedies in addition to or inconsistent with the terms of this warranty. This warranty gives you specific legal rights. You may also have other rights that vary from state to state.

Hearth & Home Technologies warrants that this Hearth & Home Technologies Outdoor Product (the "Product") will be free from defects in material and workmanship for a period of one year from its date of purchase. This warranty is subject to the conditions, exclusions and limitations described below.

This warranty applies only to the original owner of the Product and is non-transferable. Hearth & Home Technologies' obligation under this warranty does not extend to damages resulting from (1) assembly, operation or maintenance of the Product not in accordance with the Installation/Assembly Instructions, Operating Instructions and the Listing Agency Identification Label furnished with the Product; (2) installation or use which does not comply with local building codes and ordinances; (3) shipping, improper handling, improper operation, abuse, misuse, accident or unworkmanlike repairs; (4) use of fuels other than those specified in the Operating Instructions; (5) Installation or use of components not supplied with the Product or any other components not expressly authorized and approved in writing by Hearth & Home Technologies; and/or (6) modification of the Product not expressly authorized and approved in writing by Hearth & Home Technologies. Any of the circumstances described in the previous sentence voids this warranty. This warranty is void if the Product or any component has been removed, repaired, or replaced before Hearth & Home Technologies has been afforded a reasonable opportunity to inspect the Product.

This warranty is limited to the replacement or repair of defective components or workmanship and Hearth & Home Technologies may fully discharge its obligations under this warranty by repairing or replacing, at its discretion, the defective components. Hearth & Home Technologies will provide replacement parts at no charge and will pay reasonable and necessary labor and freight costs related to replacing or repairing defective components under this warranty. The maximum amount recoverable under this warranty is limited to the purchase price of the Product and, if Hearth & Home Technologies is unable to provide replacement or repair in an expedient and cost-effective manner, Hearth & Home Technologies may discharge all obligations under this warranty by refunding the purchase price of the Product.

EXCEPT TO THE EXTENT PROVIDED BY LAW, HEARTH & HOME TECHNOLOGIES MAKES NO EXPRESS WARRANTIES OTHER THAN THE WARRANTY EXPRESSED HEREIN. THE DURATION OF ANY IMPLIED WARRANTY IS LIMITED TO THE DURATION OF THE WARRANTY SPECIFIED ABOVE. IN NO EVENT SHALL HEARTH & HOME TECHNOLOGIES BE LIABLE FOR ANY INCIDENTAL OR CONSEQUENTIAL DAMAGES CAUSED BY DEFECTS IN THE PRODUCT. Some states do not allow limitations on how long an implied warranty lasts, or do not allow exclusion or limitation of incidental or consequential damages, so these limitations may not apply to you.

To obtain service under this warranty, you must:

1. Send written notice of the claimed condition to: The Technical Services Department, Hearth & Home Technologies Inc., Mt. Pleasant, 1915 W. Saunders St., Mt. Pleasant, IA 52641 (phone: 1-800-927-6841).
2. Affirm that you are the original owner of the Product.
3. Provide Hearth & Home Technologies reasonable opportunity to investigate the claim, including reasonable opportunity to inspect the Product prior to any repair or replacement work and before the Product or any component of the Product has been removed.
4. Obtain Hearth & Home Technologies' consent to any warranty work before the work is done.

B. Contact Information



HEAT & GLO

LifeStyleCollection™

Hearth & Home Technologies Inc.
20802 Kensington Blvd.
Lakeville, MN 55044
www.fireplaces.com

Please contact your Heat & Glo LifeStyle Collection dealer with any questions or concerns.
For the number of your nearest Heat & Glo LifeStyle Collection dealer, please call 1-888-427-3973.

- NOTES -

CAUTION		
	DO NOT DISCARD THIS MANUAL	
Important operating and maintenance instructions included.	Read, understand and follow these instructions for safe installation and operation.	Leave this manual with party responsible for use and operation.

This product may be covered by one or more of the following patents: (United States) 4593510, 4686807, 4766876, 4793322, 4811534, 5000162, 5016609, 5076254, 5113843, 5191877, 5218953, 5263471, 5328356, 5341794, 5347983, 5429495, 5452708, 5542407, 5601073, 5613487, 5647340, 5688568, 5762062, 5775408, 5890485, 5931661, 5941237, 5947112, 5996575, 6006743, 6019099, 6048195, 6053165, 6145502, 6170481, 6237588, 6296474, 6374822, 6413079, 6439226, 6484712, 6543698, 6550687, 6601579, 6672860, 6688302B2, 6715724B2, 6729551, 6736133, 6748940, 6748942, 6769426, 6774802, 6796302, 6840261, 6848441, 6863064, 6866205, 6869278, 6875012, 6880275, 6908039, 6919884, D320652, D445174, D462436; (Canada) 1297749, 2195264, 2225408, 2313972; (Australia) 780250, 780403, 1418504 or other U.S. and foreign patents pending.

Free Manuals Download Website

<http://myh66.com>

<http://usermanuals.us>

<http://www.somanuals.com>

<http://www.4manuals.cc>

<http://www.manual-lib.com>

<http://www.404manual.com>

<http://www.luxmanual.com>

<http://aubethermostatmanual.com>

Golf course search by state

<http://golfingnear.com>

Email search by domain

<http://emailbydomain.com>

Auto manuals search

<http://auto.somanuals.com>

TV manuals search

<http://tv.somanuals.com>