

Operator's manual (EPA)

326HDA_x-series **326HE3_x-series**

326HE4_x-series

Please read the operator's manual carefully and make sure you understand the instructions before using the machine.

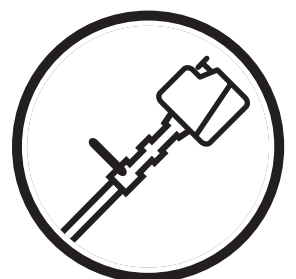

English

KEY TO SYMBOLS

Symbols

WARNING! Hedge trimmers can be dangerous! Careless or incorrect use can result in serious, even fatal injury.



Please read the operator's manual carefully and make sure you understand the instructions before using the machine.



Always wear:

- Hearing protection
- Approved eye protection



Cutting tool. Do not touch the tool without first switching off the engine.



This machine is not electrically insulated. If the machine touches or comes close to high-voltage power lines it could lead to death or serious bodily injury. Electricity can jump from one point to another by arcing. The higher the voltage, the greater the distance electricity can jump. Electricity can also travel through branches and other objects, especially if they are wet. Always keep a distance of at least 10 m between the machine and high-voltage power lines and/or any objects that are touching them. If have to work within this safe distance you should always contact the relevant power company to make sure the power is switched off before you start work. This machine can be dangerous! Make sure that no people or animals come closer than 15 m (45 ft) when the machine is running. Electricity can jump from one point to another by arcing. The higher the voltage, the greater the distance electricity can jump. Electricity can also travel through branches and other objects, especially if they are wet.

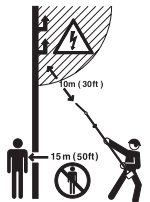

Arrows which show limits for handle positioning.



Always wear approved protective gloves.



Wear sturdy, non-slip boots.



Other symbols/decals on the machine refer to special certification requirements for certain markets.

Switch off the engine by moving the stop switch to the STOP position before carrying out any checks or maintenance.

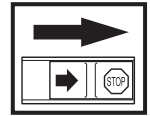

Always wear approved protective gloves.

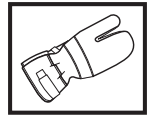

Regular cleaning is required.

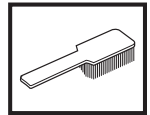

Visual check.



Approved eye protection must always be used.



CONTENTS

Contents

KEY TO SYMBOLS

Symbols 2

CONTENTS

Contents 3

Note the following before starting: 3

SAFETY INSTRUCTIONS

Personal protective equipment 4

Machine's safety equipment 4

Checking, maintaining and servicing the machine's safety equipment 6

General safety precautions 8

Fuel safety 9

Safety instructions when using the hedge trimmer 9

WHAT IS WHAT?

What is what? 12

ASSEMBLY

Fitting the hand guard and loop handle 13

Fitting the handle 13

Fitting the cutting head 13

Adjusting the harness 13

Fitting the impact guard 13

FUEL HANDLING

Fuel 14

Fuelling 15

STARTING AND STOPPING

Check before starting 16

Starting and stopping 16

MAINTENANCE

Carburettor 18

Muffler 19

Cooling system 20

Spark plug 20

Air filter 20

Gear housing 21

Cleaning and lubrication 21

Maintenance schedule 21

TECHNICAL DATA

Technical data 22

FEDERAL EMISSION CONTROL WARRANTY STATEMENT

YOUR WARRANTY RIGHTS AND OBLIGATIONS 23

Note the following before starting:

Husqvarna AB has a policy of continuous product development and therefore reserves the right to modify the design and appearance of products without prior notice.

Long-term exposure to noise can result in permanent hearing impairment. So always use approved hearing protection.



WARNING! Under no circumstances may the design of the machine be modified without the permission of the manufacturer. Always use genuine accessories. Non-authorized modifications and/or accessories can result in serious personal injury or the death of the operator or others.

Your warranty may not cover damage or liability caused by the use of non-authorized accessories or replacement parts.



WARNING! Incorrect or careless use of a hedge trimmer can turn it into a dangerous tool that can cause serious or even fatal injury. It is extremely important that you read and understand the contents of this operator's manual.



WARNING

The engine exhaust from this product contains chemicals known to the State of California to cause cancer, birth defects or other reproductive harm.

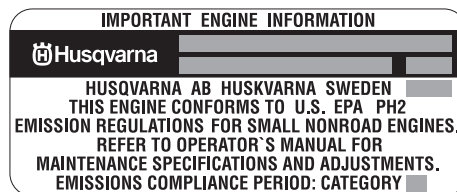

The Emissions Compliance Period referred to on the Emission Compliance label indicates the number of operating hours for which the engine has been shown to meet Federal emissions requirements. Category C = 50 hours, B = 125 hours, and A = 300 hours.

For customer assistance call: 704-921-7000 or contact us at our website: www.husqvarna.com

SAFETY INSTRUCTIONS

Personal protective equipment

IMPORTANT INFORMATION

Incorrect or careless use of a hedge trimmer can turn it into a dangerous tool that can cause serious or even fatal injury. It is extremely important that you read and understand the contents of this operator's manual.

Whenever you use the hedge trimmer you must use personal protective equipment that is approved by the authorities. Personal protective equipment does not eliminate the risk of injury, but it can reduce the degree of injury in the event of an accident. Ask your dealer for help when choosing equipment.



WARNING! Remove your hearing protection as soon as you stop the engine, so that you can hear any noises or warning signals.

GLOVES

Gloves must be worn when required, for example when fitting, inspecting or cleaning cutting attachments.



HEARING PROTECTION

Wear hearing protection that provides adequate noise reduction.

EYE PROTECTION

Blows from branches or objects thrown by the moving blades can damage the eyes.

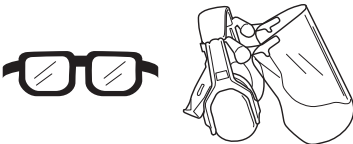

BOOTS

Wear sturdy, non-slip boots.



CLOTHING

Wear clothes made of a strong fabric and avoid loose clothing that can catch on twigs and branches. Always wear heavy, long pants. Do not wear jewellery, shorts sandals or go barefoot. Secure hair so it is above shoulder level.

FIRST AID KIT

Always have a first aid kit nearby.



Machine's safety equipment

This section describes the machine's safety equipment, its purpose, and how checks and maintenance should be carried out to ensure that it operates correctly. See the "What is what?" section to locate where this equipment is positioned on your machine.



WARNING! Never use a machine that has faulty safety equipment! Carry out the inspection, maintenance and service routines listed in this section.

Throttle lock

The throttle lock is designed to prevent accidental operation of the throttle control. When you press the lock (A) (i.e. when you grasp the handle) it releases the throttle control (B). When you release the handle the throttle control and the throttle lock both move back to their original positions. This movement is controlled by two independent return springs. This arrangement means that the throttle control is automatically locked at the idle setting.

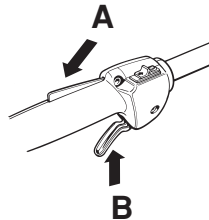

Stop switch

Use the stop switch to switch off the engine.

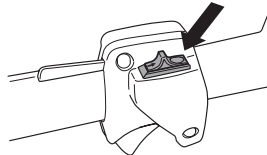

Hand guard

(326HDA55/326HE3)

The hand guard prevents hands from coming into contact with the moving blades, for example, if the operator loses grip on the front handle.

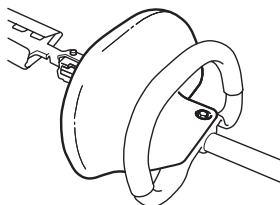

SAFETY INSTRUCTIONS

Vibration damping system

Your machine is equipped with a vibration damping system that is designed to minimise vibration and make operation easier.

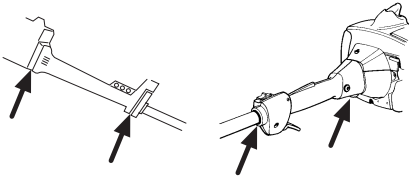

The machine's vibration damping system reduces the transfer of vibration between the engine unit/cutting equipment and the machine's handle unit.

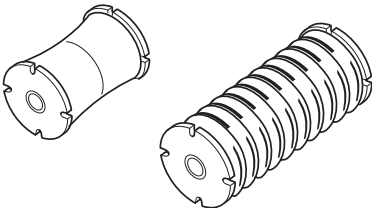

WARNING! Overexposure to vibration can lead to circulatory damage or nerve damage in people who have impaired circulation. Contact your doctor if you experience symptoms of overexposure to vibration. These symptoms include numbness, loss of feeling, tingling, pricking, pain, loss of strength, changes in skin colour or condition. These symptoms normally appear in the fingers, hands or wrists.

Muffler

The muffler is designed to keep noise levels to a minimum and to direct exhaust fumes away from the user.

A muffler fitted with a catalytic converter is also designed to reduce harmful exhaust gases.

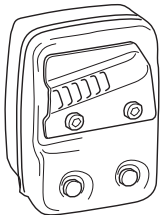

In countries that have a warm and dry climate there is a significant risk of fire. We therefore fit certain mufflers with a spark arrestor mesh. Check whether the muffler on your machine is fitted with this kind of mesh.

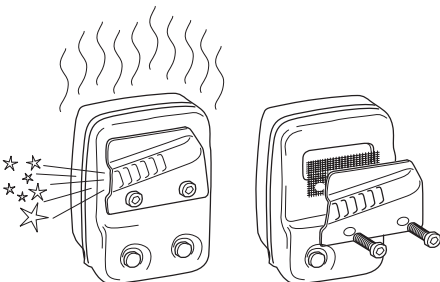

For mufflers it is very important that you follow the instructions on checking, maintaining and servicing your machine. See instructions under the heading Checking, maintaining and servicing the machine's safety equipment.



WARNING! Mufflers fitted with catalytic converters get very hot during use and remain so for some time after stopping. This also applies at idle speed. Contact can result in burns to the skin. Remember the risk of fire!



WARNING! The inside of muffler contain chemicals that may be carcinogenic. Avoid contact with these elements in the event of a damaged muffler.



WARNING! Engine exhaust fumes contain carbon monoxide, which can cause carbon monoxide poisoning. For this reason you should not start or run the machine indoors, or anywhere that is poorly ventilated.

The exhaust fumes from the engine are hot and may contain sparks which can start a fire. Never start the machine indoors or near combustible material!

Cutter guard

(326HDA55)

The blade guard (A) is intended to protect against any part of the body coming into contact with the blades (B).

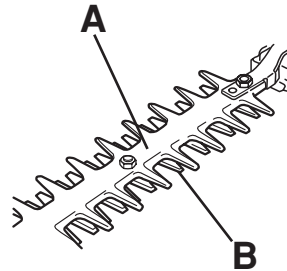

SAFETY INSTRUCTIONS

Checking, maintaining and servicing the machine's safety equipment

IMPORTANT! All servicing and repair work on the machine requires special training. This is especially true of the machine's safety equipment. If your machine fails any of the checks described below you must contact your service agent. When you buy any of our products we guarantee the availability of professional repairs and service. If the retailer who sells your machine is not a servicing dealer, ask him for the address of your nearest service agent.

Throttle lock

- Make sure the throttle control is locked at the idle setting when the throttle lock is released.

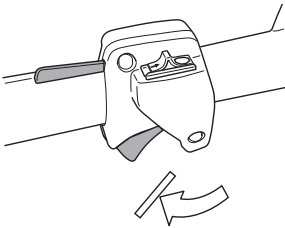

- Press the throttle lock and make sure it returns to its original position when you release it.

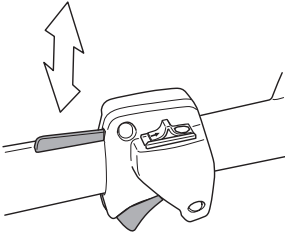

- Check that the throttle control and throttle lock move freely and that the return springs work properly.

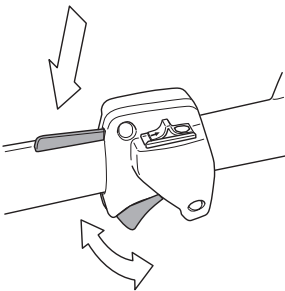

- See instructions under the heading Start. Start the machine and apply full throttle. Release the throttle and check that the cutting attachment stops and remains at a standstill. If the cutting attachment rotates with the throttle in the idle position then the carburettor idle setting must be checked. See instructions under the heading Maintenance.

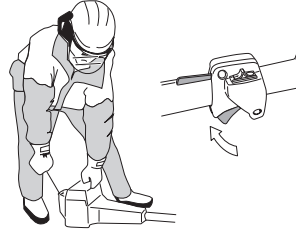

WARNING! Never use a machine with faulty safety equipment. The machine's safety equipment must be checked and maintained as described in this section. If your machine fails any of these checks contact your service agent to get it repaired.



WARNING! Always stop the engine before doing any work on the cutting attachment. This continues to rotate even after the throttle has been released. Ensure that the cutting attachment has stopped completely and disconnect the HT lead from the spark plug before you start to work on it.

Stop switch

- Start the engine and make sure the engine stops when you move the stop switch to the stop setting.

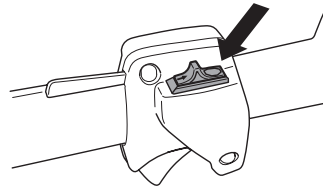

Hand guard

(326HDA55/326HE3)

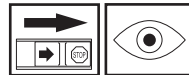

- Check that the hand guard is fitted correctly.

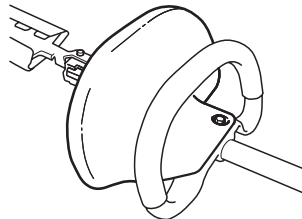

- Check that the hand guard is undamaged.

SAFETY INSTRUCTIONS

Vibration damping system

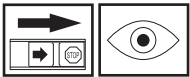

- Regularly check the vibration damping units for cracks or deformation.

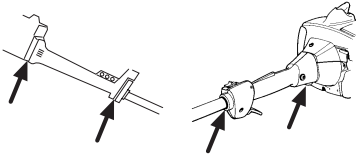

- Check that the vibration damping element is undamaged and securely attached.

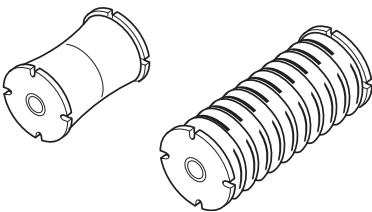

Muffler



- Never use a machine that has a faulty muffler.

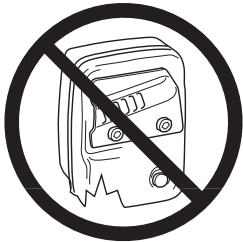

- Regularly check that the muffler is securely attached to the machine.

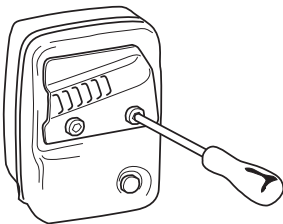

If the muffler on your machine is fitted with a spark arrestor mesh then it should be cleaned regularly. A blocked mesh causes the engine to overheat, which can lead to serious damage.

Never use a muffler with a defective spark arrestor mesh.

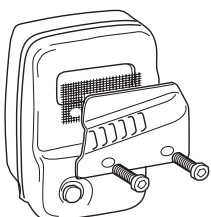

Blades

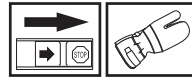

- To ensure good cutting results it is important that the contact pressure between the blades is correct. The contact pressure is adjusted by turning the screws on the underside of the bar clockwise as far as they will go. Then turn the screws anticlockwise a 1/4 turn. Lock the screws using the locking nut on the top of the bar. Check that the screws are loose enough to allow the washers under the screw heads to slide sideways.

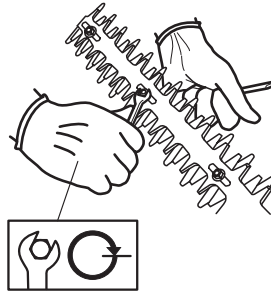

- When the blades are correctly adjusted the play between the blades should be 0,2–0,4 mm, measured at the screws.

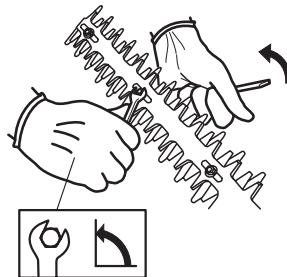

- The edges of the blades are too hard to be filed. Dull blades should be sharpened using a grinder.

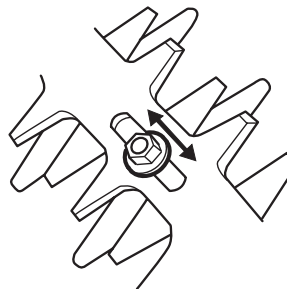

- Replace the blades if they are bent or damaged.

SAFETY INSTRUCTIONS

Cutter guard

(326HDA55)



- Check that the blade guard is not damaged or distorted.
- Replace the blade guard if it is bent or damaged.

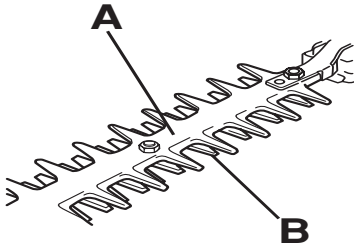

Gear housing

- The gear housing gets hot when the machine has been in use. To avoid burning yourself do not touch the gear housing.

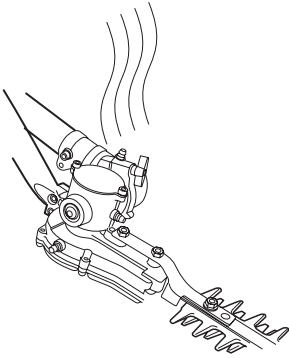

General safety precautions

IMPORTANT!

The machine is only designed for cutting branches and twigs.

Never use the machine if you are tired, if you have drunk alcohol, or if you are taking medication that could affect your vision, your judgement or your co-ordination.

Wear personal protective equipment. See instructions under the heading Personal protective equipment.

Never use a machine that has been modified in any way from its original specification.

Never use a machine that is faulty. Carry out the checks, maintenance and service instructions described in this manual. Some maintenance and service measures must be carried out by trained and qualified specialists. See instructions under the heading Maintenance.

All covers and guards must be fitted before starting. Make sure the spark plug cap and HT lead are not damaged. Otherwise you could get an electric shock.



WARNING! Faulty blades can increase the risk of accidents.

Starting



- The complete clutch cover and shaft must be fitted before the machine is started, otherwise the clutch can come loose and cause personal injury.
- Never start the machine indoors. Exhaust fumes can be dangerous if inhaled.
- Observe your surroundings and make sure that there is no risk of people or animals coming into contact with the cutting equipment.
- Place the machine on the ground, ensure the cutting attachment is clear of twigs and stones. Hold the body of the machine on the ground using your left hand (CAUTION! Not with your foot). Then grip the starter handle with your right hand and pull the starter cord.

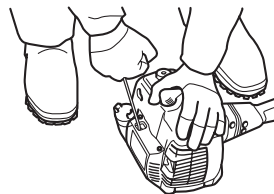

SAFETY INSTRUCTIONS

Fuel safety



- Always use a fuel container with an anti-spill valve.
- Never refuel the machine while the engine is running. Always stop the engine and let it cool for a few minutes before refuelling.
- Make sure there is plenty of ventilation when refuelling or mixing fuel (gasoline and 2-stroke oil).
- Move the machine at least 3 m from the refuelling point before starting it.

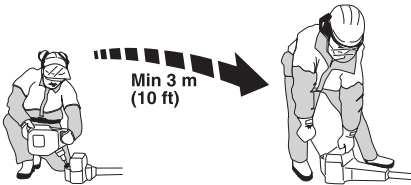

- Never start the machine:
 - 1 If you have spilt fuel on it. Wipe off the spillage and allow remaining fuel to evaporate.
 - 2 If you spill fuel or chain oil on yourself or your clothes. Change your clothes.
 - 3 If the machine is leaking fuel. Check regularly for leaks from the fuel cap and fuel lines.

Transport and storage

- Store and transport the machine and fuel so that there is no risk of any leakage or fumes coming into contact with sparks or naked flames, for example, from electrical machinery, electric motors, electrical relays/switches or boilers.
- When storing and transporting fuel always use approved containers intended for this purpose.
- When storing the machine for long periods the fuel tank must be emptied. Contact your local gas station to find out where to dispose of excess fuel.
- Ensure the machine is cleaned and that a complete service is carried out before long-term storage.
- The transport guard must always be fitted to the cutting attachment when the machine is being transported or in storage.



WARNING! Take care when handling fuel. Bear in mind the risk of fire, explosion and inhaling fumes.

Safety instructions when using the hedge trimmer



WARNING! The machine can cause serious personal injury. Read the safety instructions carefully. Learn how to use the machine.



WARNING! Cutting tool. Do not touch the tool without first switching off the engine.

CAUTION! Please read the operator's manual carefully and make sure you understand the instructions before using the machine.

Personal protection

- Always wear boots and other equipment described under the heading Personal protective equipment.
- Always wear working clothes and heavy-duty long trousers.
- Never wear loose clothing or jewellery.
- Make sure your hair does not hang below shoulder level.



Safety instructions regarding the surroundings

- Never allow children to use the machine.
- Ensure that no-one comes closer than 15 m while you are working.
- Never allow anyone else to use the machine without first ensuring that they have understood the contents of the operator's manual.
- Never work from a ladder, stool or any other raised position that is not fully secured.

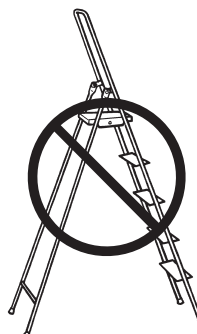

SAFETY INSTRUCTIONS

Safety instructions while working



- Always ensure you have a safe and stable working position
- Always use both hands to hold the machine. Hold the machine at the side of your body.

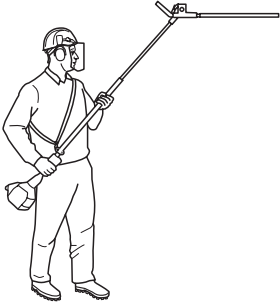

- Use your right hand to control the throttle setting.

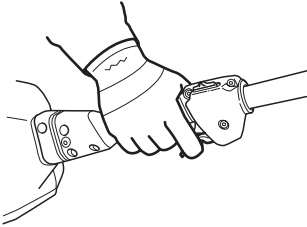

- Make sure that your hands and feet do not come near the cutting attachment when the engine is running.
- When the engine is switched off, keep your hands and feet away from the blades until they have stopped.
- Watch out for stumps of branches that can be thrown out during cutting.
- Always lay the machine on the ground when you are not using it.
- Do not cut too close to the ground. Stones and other objects can be thrown out.
- Check the working area for foreign objects such as electricity cables, insects and animals, etc, or other objects that could damage the cutting attachment, such as metal items.
- If any foreign object is hit or if vibrations occur stop the machine immediately. Disconnect the HT lead from the spark plug. Check that the machine is not damaged. Repair any damage.
- If anything jams in the blades while you are working, switch off the engine and wait until it has stopped completely before cleaning the blades. Disconnect the HT lead from the spark plug.

Safety instructions after completing work



- The transport guard should always be fitted to the cutting attachment when the machine is not in use.
- Make sure the cutting attachment has stopped before cleaning, carrying out repairs or an inspection. Disconnect the HT lead from the spark plug.
- Always wear heavy-duty gloves when repairing the cutting attachment. The blades are very sharp and can easily cause cuts.

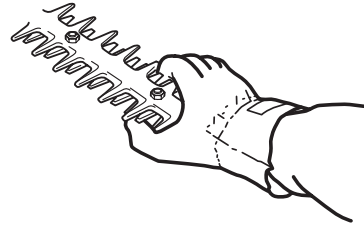

- Store the machine out of reach of children.
- Use only original spare parts for repairs.

Basic working techniques

- Work with a swinging action from the bottom upwards when trimming sides.

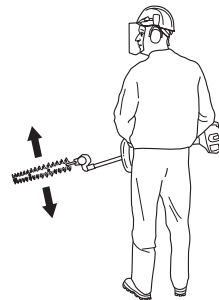

- Adjust the throttle setting to suit the load.
- When trimming a hedge the engine should always face away from the hedge.
- Hold the machine as close to your body as possible to get the best balance.
- Make sure that the tip does not touch the ground.
- Do not rush the work, but work steadily until all the branches have been cut back cleanly.

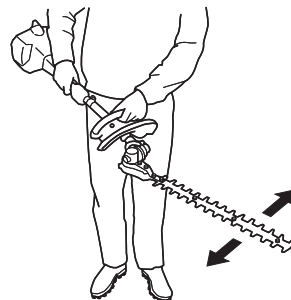

SAFETY INSTRUCTIONS

Changing the hedge trimmer angle



(326HE3, 326HE4)

- Undo the knob.
- Grasp the handle on the angle stop, adjust to the desired angle and then tighten the knob.

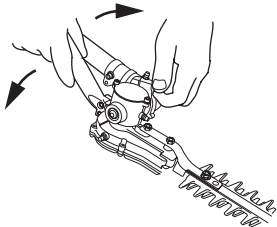

(326HDA55)

- Undo the knob.

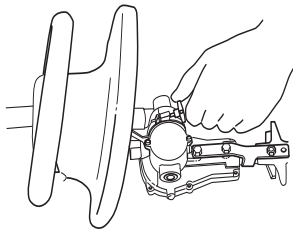

- Press the cutting head against the ground or some other solid object until the desired angle has been obtained.

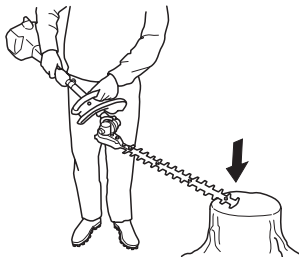

- Tighten the knob.

CAUTION! Do not hold the cutting head when you adjust the angle. The blades are sharp and you could easily cut yourself.

WHAT IS WHAT?

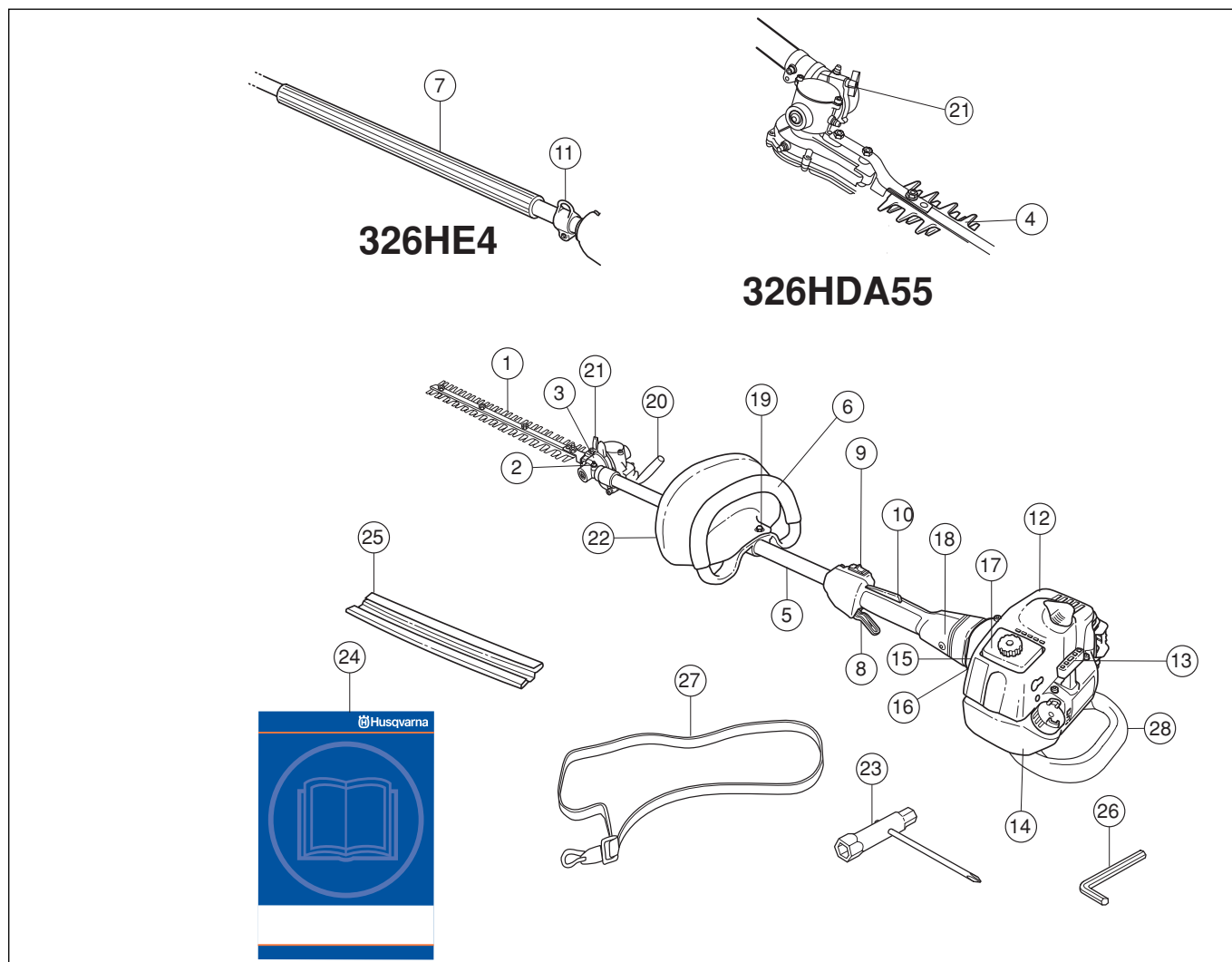

What is what?

- | | |
|----------------------------------|--|
| 1 Cutter | 15 Choke control |
| 2 Grease nipples (3) | 16 Air purge |
| 3 Bevel gear | 17 Air filter cover |
| 4 Cutter guard (326HDA55) | 18 Clutch cover |
| 5 Shaft | 19 Hand guard mounting screw (326HDA55/326HE3) |
| 6 Front handle (326HDA55/326HE3) | 20 Angle adjustment handle (326HE3, 326HE4) |
| 7 Front handle (326HE4) | 21 Angle adjustment knob |
| 8 Throttle control | 22 Hand guard (326HDA55/326HE3) |
| 9 Stop switch | 23 Combination spanner |
| 10 Throttle lock | 24 Operator's manual (EPA) |
| 11 Harness support hook (326HE4) | 25 Transport guard |
| 12 Cylinder cover | 26 Allen key |
| 13 Starter handle | 27 Harness (326HE4) |
| 14 Fuel tank | 28 Impact guard (326HE4) |

ASSEMBLY

Fitting the hand guard and loop handle

(326HDA55/326HE3)

- 1 Assemble the hand guard and loop handle by screwing them together. Take care to align the holes in both parts.

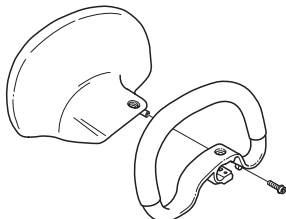

- 2 Slide the loop handle and hand guard onto the shaft.
- 3 Slide the spacer into the slot in the loop handle.
- 4 Fit the nut and screw. Do not overtighten.

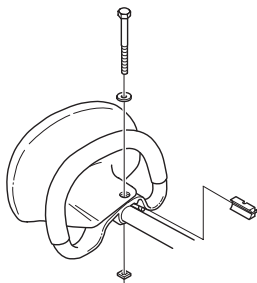

- 5 Now make a final adjustment to give yourself a comfortable working position. Tighten the screw. CAUTION! The loop handle and hand guard must not be fitted behind the arrow marked on the shaft.

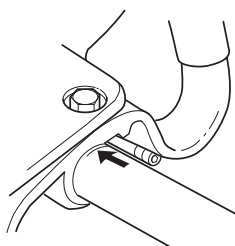

Fitting the handle

(326HE3, 326HE4)

Fit the handle using two screws.

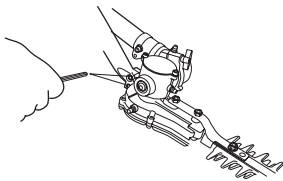

Fitting the cutting head

It is important that the hedge trimmer is laid on a flat surface when you fit the cutting head. Otherwise the cutting head may not be fitted straight.

- 1 Fit the cutting head to the shaft. CAUTION! Make sure the drive shaft inside the shaft engages with the recess in the cutting head.
- 2 Tighten the lower screw first, then the upper screw.

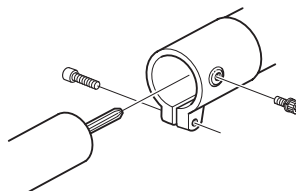

Adjusting the harness

(326HE4)



You should always use the harness with the machine to give maximum control over the machine and reduce the risk of fatigue in your arms and back.

- 1 Put on the harness.
- 2 Hook the machine onto the harness support hook.
- 3 Adjust the length of the harness so that the support hook is roughly level with your right hip.

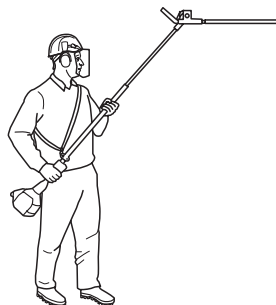

Fitting the impact guard

(326HE4)

Fit the guard using the three screws and washers. Fit the two short screws in hole A. Tighten the screws to a torque of 4 Nm. After the machine has been in use for around 20 hours, re-tighten the screws to 4 Nm.

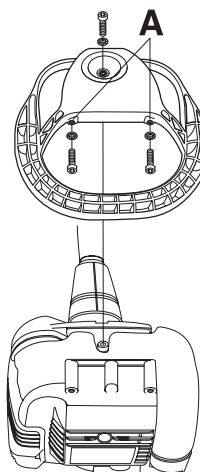

FUEL HANDLING

Fuel

CAUTION! The machine is equipped with a two-stroke engine and must always be run using a mixture of gasoline and two-stroke engine oil. It is important to accurately measure the amount of oil to be mixed to ensure that the correct mixture is obtained. When mixing small amounts of fuel, even small inaccuracies can drastically affect the ratio of the mixture.

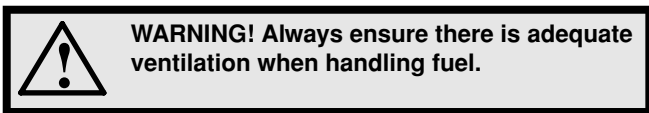

Gasoline



CAUTION!

Always use high grade unleaded oil mixed gasoline (minimum 87 RON). If your machine is equipped with a catalytic converter (see chapter on Technical data) always use a good quality unleaded petrol/oil mixture. Leaded petrol will destroy the catalytic converter and it will no longer serve its purpose.

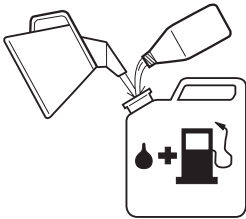

- The lowest recommended octane rating is 87. If you run the engine on lower octane rating than 87 so-called "knocking" can occur. This leads to an increased engine temperature, which can result in a serious engine breakdown.
- When working at continuous high revs a higher octane rating is recommended.

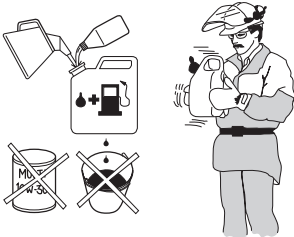

Two-stroke oil

- For best results and performance use HUSQVARNA two-stroke oil, which is specially formulated for our two-stroke engines. Mixture 1:50 (2%).
- Never use two-stroke oil intended for water-cooled outboard engines, sometimes referred to as outboard oil.
- Never use oil intended for four-stroke engines.

Gasoline, litre	Two-stroke oil, litre	
	2% (1:50)	3% (1:33)
5	0,10	0,15
10	0,20	0,30
15	0,30	0,45
20	0,40	0,60
US gallon	US fl. oz.	
	2% (1:50)	3% (1:33)
1	2 1/2	3 3/4
2 1/2	6 1/2	9 3/4
5	12 7/8	19 1/4

Mixing

- Always mix the gasoline and oil in a clean container intended for fuel.
- Always start by filling half the amount of the gasoline to be used. Then add the entire amount of oil. Mix (shake) the fuel mixture. Add the remaining amount of gasoline.
- Mix (shake) the fuel mixture thoroughly before filling the machine's fuel tank.



- Do not mix more than one month's supply of fuel at a time.
- If the machine is not used for some time the fuel tank should be emptied and cleaned.

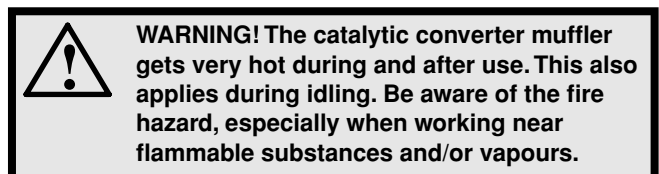

FUEL HANDLING

Fuelling



WARNING! Taking the following precautions, will lessen the risk of fire:

Do not smoke or place hot objects near fuel.

Always shut off the engine before refuelling.

Always stop the engine and let it cool for a few minutes before refuelling.

When refuelling, open the fuel cap slowly so that any excess pressure is released gently.

Tighten the fuel cap carefully after refuelling.

Always move the machine away from the refuelling area before starting.

- Clean the area around the fuel cap. Contamination in the tank can cause operating problems.
- Ensure that the fuel is well mixed by shaking the container before filling the tank.

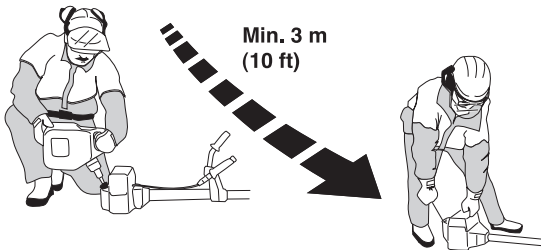

STARTING AND STOPPING

Check before starting

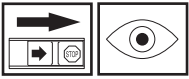

- Inspect the working area. Remove any objects that could be thrown out.
- Check the cutting attachment. Never use blades that are dull, cracked or damaged.

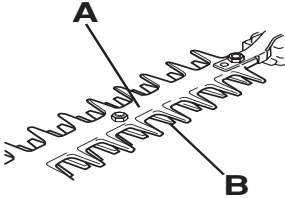

- Check that the machine is in perfect working order. Check that all nuts and screws are tight.
- Make sure the gear housing is lubricated correctly. See instructions under the heading Gear housing.
- Check that the blades do not move when the engine is idling.
- Only use the machine for the purpose it was intended for.
- Make sure that the handle and safety features are in good working order. Never use a machine that lacks a part or has been modified outside its specifications.

Starting and stopping



Starting



WARNING! The complete clutch cover and shaft must be fitted before the machine is started, otherwise the clutch can come loose and cause personal injury.

Always move the machine about 3 metres from the refuelling position before starting. Place the machine on a firm surface. Remember that the blades may start to move when the engine is started. Make sure the blades cannot come into contact with any object. Make sure that no unauthorised persons are in the working area, otherwise there is a risk of serious personal injury.

Cold engine



Ignition: Set the stop switch to the start position.

Choke: Set the choke control in the choke position.

Air purge: Press the air purge diaphragm repeatedly until fuel begins to fill the diaphragm. The diaphragm need not be completely filled.

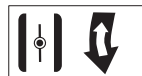
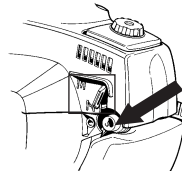

Warm engine

Ignition: Set the stop switch to the start position.

Air purge: Press the air purge diaphragm repeatedly until fuel begins to fill the diaphragm. The diaphragm need not be completely filled.

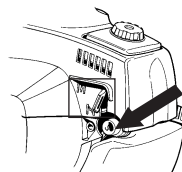

STARTING AND STOPPING

Hold the body of the machine on the ground using your left hand (CAUTION! Not with your foot!). Grip the starter handle, slowly pull out the cord with your right hand until you feel some resistance (the starter pawls grip), now quickly and powerfully pull the cord.

Push the choke control back to its original position as soon as the engine fires, and continue trying to start until the engine starts.



CAUTION! Do not pull the starter cord all the way out and do not let go of the starter handle when the cord is fully extended. This can damage the machine.

Stopping

The engine is stopped by switching the ignition off using the stop switch.

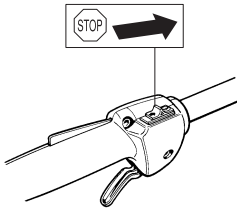

MAINTENANCE

Carburettor

Your Husqvarna product has been designed and manufactured to specifications that reduce harmful emissions. After the engine has used 8-10 tanks of fuel the engine will be run-in. To ensure that it continues to run at peak performance and to minimise harmful exhaust emissions after the running-in period, ask your dealer/service workshop (who will have a rev counter at their disposal) to adjust your carburettor.



WARNING! The complete clutch cover and shaft must be fitted before the machine is started, otherwise the clutch can come loose and cause personal injury.

Function



- The carburettor governs the engine's speed via the throttle control. Air and fuel are mixed in the carburettor. The air/fuel mixture is adjustable. Correct adjustment is essential to get the best performance from the machine.
- The setting of the carburetor means that the engine is adapted to local conditions, for example, the climate, altitude, fuel and the type of 2-stroke oil.
- The carburettor has three adjustment controls:
 - L = Low speed jet
 - H = High speed jet
 - T = Idle adjustment screw
- The L and H-jets are used to adjust the supply of fuel to match the rate that air is admitted, which is controlled with the throttle. If they are screwed clockwise the air/fuel ratio becomes leaner (less fuel) and if they are turned anti-clockwise the ratio becomes richer (more fuel). A lean mixture gives a higher engine speed and a rich mixture gives a lower engine speed.
- The T-screw regulates the throttle setting at idle speed. If the T-screw is turned clockwise this gives a higher idle speed; turning it anti-clockwise gives a lower idle speed.

Basic setting

- The basic carburettor settings are adjusted during testing at the factory. The basic setting is richer than the optimal setting and should be maintained for the first few hours the machine is in use. The carburettor should then be finely adjusted. Fine adjustment should be carried out by a skilled technician.

CAUTION! If the cutting attachment rotates when the engine is idling the idle adjustment screw T should be turned anti-clockwise until the cutting attachment stops.

Rec. idle speed: 2700 rpm

Recommended max. speed: See the Technical data section.



WARNING! If the idle speed cannot be adjusted so that the cutting attachment stops, contact your dealer/service workshop. Do not use the machine until it has been correctly adjusted or repaired.

Fine adjustment

- When the machine has been "run-in" the carburettor should be finely adjusted. **The fine adjustment should be carried out by a qualified person.** First adjust the L-jet, then the idling screw T and then the H-jet.

Conditions

- Before any adjustments are made, make sure that the air filter is clean and the air filter cover is fitted. If you adjust the carburettor when the air filter is dirty it will result in a leaner mixture when the filter is finally cleaned. This can lead to serious engine damage.
- Carefully turn both jets, L and H, so that they are midway between fully screwed in and fully screwed out.
- Do not attempt to adjust the L and H jets beyond either stop as this could cause damage.
- Now start the machine according to the starting instructions and let it warm up for 10 minutes.

CAUTION! If the cutting attachment rotates when the engine is idling the idle adjustment screw T should be turned anti-clockwise until the cutting attachment stops.

Low speed jet L

Try to find the highest idling speed, turning the low speed needle L clockwise respectively counter-clockwise. When the highest speed has been found, turn the low speed needle L 1/4 turn counter-clockwise.

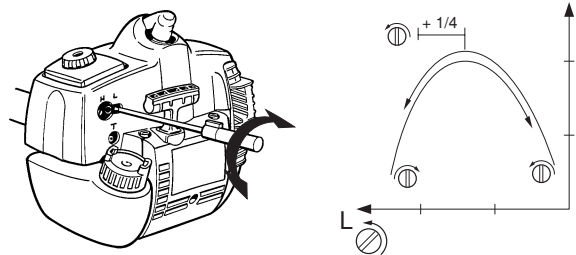

CAUTION! If the cutting attachment rotates when the engine is idling the idle adjustment screw T should be turned anti-clockwise until the cutting attachment stops.

Fine adjustment of the idle speed T

Adjust the idle speed with the idle adjustment screw T, if adjustment is necessary. First turn the idle adjustment screw T clockwise until the blades start to move. Then turn the idle adjustment screw T anticlockwise until the blades stop. The idle speed is correctly adjusted when the engine runs smoothly in every position. There should also be a clear margin to the speed at which the blades start to move.

The blades must also remain stationary when the choke control is in the start throttle position.

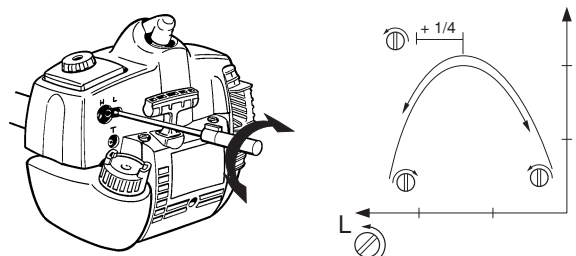

IMPORTANT! If the idle speed cannot be adjusted so that the cutting attachment stops, contact your dealer/service workshop. Do not use the machine until it has been correctly adjusted or repaired.

MAINTENANCE

High speed jet H

The high speed jet H affects the engine power, speed, temperature and fuel consumption. If the high speed jet H is set too lean (screwed in too far) the engine speed will be too high and cause engine damage. Do not let the engine run at full speed for more than 10 seconds.

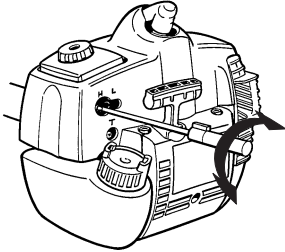

Apply full throttle and turn the high speed jet H very slowly clockwise until the engine slows down. Then turn the high speed jet H very slowly anticlockwise until the engine starts to run unevenly. Now turn the high speed jet H slowly clockwise a little way until the engine runs smoothly.

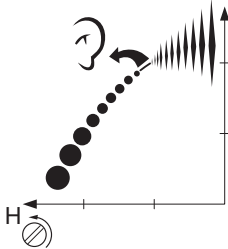

Note that the engine should not be under load when you adjust the high speed jet H. You should therefore remove the cutting attachment, nut, support flange and drive disc before adjusting the high speed jet H.

The high speed jet H is adjusted correctly when the machine burbles a little. If the machine races then the setting is too lean. If the engine produces a lot of smoke and burbles a lot then the setting is too rich.

CAUTION! For optimum adjustment of the carburettor, contact a qualified dealer/service workshop that has a revolution counter at their disposal.

Correctly adjusted carburettor

When the carburettor is correctly adjusted the machine accelerates without hesitation and burbles a little at maximum speed. It is also important that the blades do not move when the engine is idling or when the choke control is in the start position. If the low speed jet L is set too lean it may cause starting difficulties and poor acceleration.

If the high speed jet H is set too lean it will result in less power, less performance, poor acceleration and/or damage to the engine.

If both the L and H jets are set too rich it will result in acceleration problems or too low a working speed.

Muffler

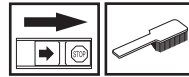

CAUTION! Some mufflers are fitted with a catalytic converter. See chapter on Technical data to see whether your machine is fitted with a catalytic converter.

The muffler is designed to reduce the noise level and to direct the exhaust gases away from the operator. The exhaust gases are hot and can contain sparks, which may cause fire if directed against dry and combustible material.

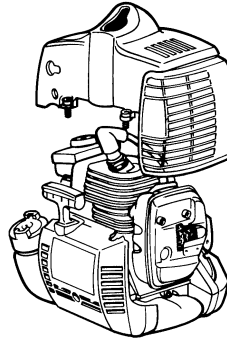

Some mufflers are equipped with a special spark arrestor mesh. If your machine has this type of muffler, you should clean the mesh at least once a week. This is best done with a wire brush.

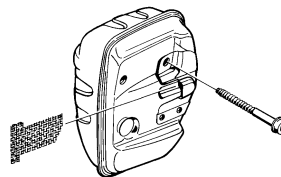

On mufflers without a catalytic converter the mesh should be cleaned weekly, or replaced if necessary. On mufflers fitted with a catalytic converter the mesh should be checked, and if necessary cleaned, monthly. **If the mesh is damaged it should be replaced.**

If the mesh is frequently blocked, this can be a sign that the performance of the catalytic converter is impaired. Contact your dealer to inspect the muffler. A blocked mesh will cause the machine to overheat and result in damage to the cylinder and piston. See also instructions under the heading Maintenance.

CAUTION! Never use a machine with a defective muffler.



WARNING! Mufflers fitted with catalytic converters get very hot during use and remain so for some time after stopping. This also applies at idle speed. Contact can result in burns to the skin. Remember the risk of fire!

MAINTENANCE

Cooling system

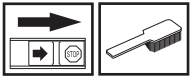

To keep the working temperature as low as possible the machine is equipped with a cooling system.

The cooling system consists of:

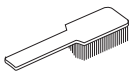
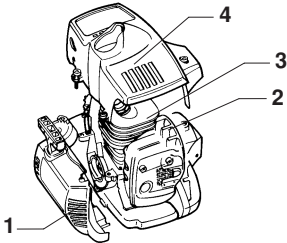

- 1 Air intake on the starter.
- 2 Fins on the flywheel.
- 3 Cooling fins on the cylinder.
- 4 Cylinder cover (directs cold air over the cylinder).

Clean the cooling system with a brush once a week, more often in demanding conditions. A dirty or blocked cooling system results in the machine overheating which causes damage to the piston and cylinder.

Spark plug



The spark plug condition is influenced by:

- Incorrect carburettor adjustment.
- An incorrect fuel mixture (too much or incorrect type of oil).
- A dirty air filter.

These factors cause deposits on the spark plug electrodes, which may result in operating problems and starting difficulties.

If the machine is low on power, difficult to start or runs poorly at idle speed: always check the spark plug first before taking any further action. If the spark plug is dirty, clean it and check that the electrode gap is 0.5 mm (0,020"). The spark plug should be replaced after about a month in operation or earlier if necessary.

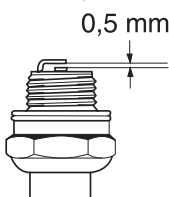

CAUTION! Always use the recommended spark plug type! Use of the wrong spark plug can damage the piston/cylinder.

Air filter

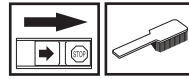

The air filter must be regularly cleaned to remove dust and dirt in order to avoid:

- Carburettor malfunctions
- Starting problems
- Loss of engine power
- Unnecessary wear to engine parts
- Excessive fuel consumption.

Clean the filter every 25 hours, or more regularly if conditions are exceptionally dusty.

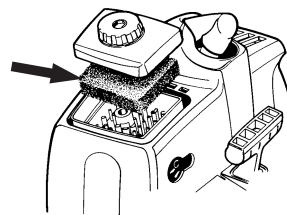

Cleaning the air filter

Remove the air filter cover and take out the filter. Wash it clean in warm, soapy water. Ensure that the filter is dry before refitting it.

An air filter that has been in use for a long time cannot be cleaned completely. The filter must therefore be replaced with a new one at regular intervals. **A damaged air filter must always be replaced.**

If the machine is used in dusty conditions the air filter should be soaked in oil. See instructions under the heading Oiling the air filter.

Oiling the air filter

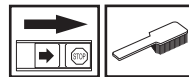

Always use HUSQVARNA filter oil, art. no. 531 00 92-48. The filter oil contains a solvent to make it spread evenly through the filter. You should therefore avoid skin contact.

Put the filter in a plastic bag and pour the filter oil over it. Knead the plastic bag to distribute the oil. Squeeze the excess oil out of the filter inside the plastic bag and pour off the excess before fitting the filter to the machine. Never use common engine oil. This would drain through the filter quite quickly and collect in the bottom.

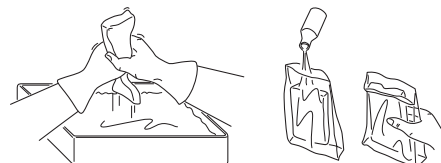

MAINTENANCE

Gear housing



There are three grease nipples on the gear housing. Use a grease gun to top up with grease. This should be carried out approximately every 20 working hours. Use Husqvarna special grease, part no. 503 98 96-01.

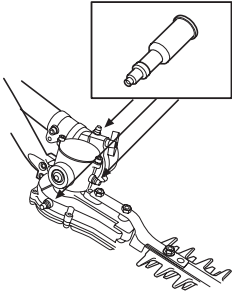

The grease in the bevel gear does not normally need to be changed except if repairs are carried out.

Cleaning and lubrication



After you have used the machine clean any resin and plant residue from the blades using cleaning agent 531 00 60-75 (UL22).

Always lubricate the blade bars with special grease, part no. 531 00 60-74 (UL 21) before use.

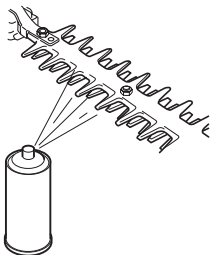

Maintenance schedule

Below you will find some general maintenance instructions. If you need further information please contact your service workshop.

Daily maintenance

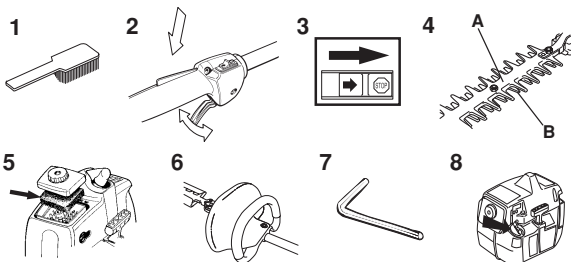

- 1 Clean the outside of the machine.
- 2 Check that the stop switch works correctly.
- 3 Check that the blades do not move when the engine is idling or when the choke is in the start throttle position.
- 4 Clean the air filter. Replace if necessary.

- 5 Check that the hand guard is not damaged. Replace the guard if damaged.
- 6 Check that nuts and screws are tight.
- 7 Check that there are no fuel leaks from the engine, tank or fuel lines.

Weekly maintenance

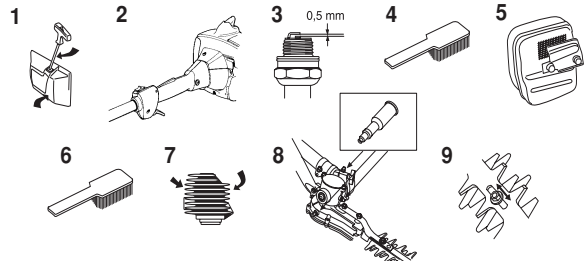

- 1 Check the starter, the starter cord and the recoil spring.
- 2 Check that the vibration damping elements are not damaged.
- 3 Clean the outside of the spark plug. Remove and check the electrode gap. Adjust the gap to 0.5 mm or change the spark plug.
- 4 Clean the cooling fins on the flywheel.
- 5 Clean or replace the spark arrestor mesh on the muffler (only applies to mufflers without a catalytic converter).
- 6 Clean the carburettor compartment.
- 7 Clean the cooling fins on the cylinder and check that the air intake near the starter is not blocked.
- 8 Fill the gear housing with grease. This should be carried out approximately every 20 working hours.
- 9 Check that the screws that hold the blades together are correctly tightened.

Monthly maintenance

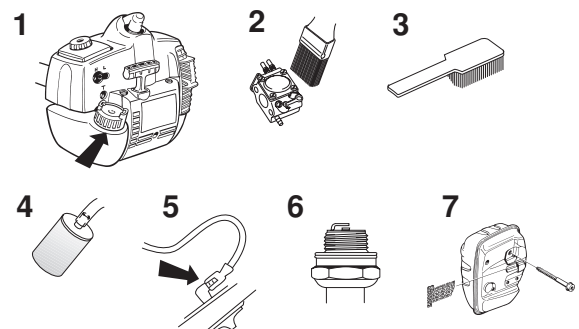

- 1 Clean the fuel tank.
- 2 Clean the outside of the carburettor and the space around it.
- 3 Clean the fan and the area around it.
- 4 Check fuel hose for cracks or other damage. Change if necessary.
- 5 Check all cables and connections.
- 6 Check the clutch, clutch springs and the clutch drum for wear. Replace if necessary.
- 7 Replace the spark plug. Check that the spark plug is fitted with a suppressor.
- 8 Check and clean the spark arrestor mesh on the muffler (only applies to mufflers fitted with a catalytic converter).

TECHNICAL DATA

Technical data

	326HDA55	326HE3	326HE4
Engine			
Cylinder volume, cu.in/cm ³	1,50/24,5	1,50/24,5	1,50/24,5
Cylinder bore, inch/mm	1,34/34,0	1,34/34,0	1,34/34,0
Stroke, inch/mm	1,06/27	1,06/27	1,06/27
Idle speed, rpm	2700	2700	2700
Recommended max. speed, rpm	9500-10500	9500-10500	9500-10500
Max. engine output, acc. to ISO 8893, kW/ rpm	0,9/9000	0,9/9000	0,9/9000
Catalytic converter muffler	Yes	Yes	Yes
Speed-regulated ignition system	Yes	Yes	Yes
Ignition system			
Manufacturer/type of ignition system	WalbroMB/SEM AM49	WalbroMB/SEM AM49	WalbroMB/SEM AM49
Spark plug	NGK BPMR 7A	NGK BPMR 7A	NGK BPMR 7A
Electrode gap, inch/mm	0,02/0,5	0,02/0,5	0,02/0,5
Fuel and lubrication system			
Manufacturer/type of carburettor	Zama C1Q	Zama C1Q	Zama C1Q
Fuel tank capacity, US pint/litre	1,06/0,5	1,06/0,5	1,06/0,5
Weight			
Weight without fuel, kg	12,1/5,5	12,6/5,7	12,8/5,8
Sound levels			
(see note 1)			
Equivalent noise pressure level at the operator's ear, measured according to EN/ISO 11806 and ISO 7917, dB(A), min./max.:	94	92	88
Vibration levels			
Vibration levels at handles, measured according to EN/ISO 11806 and ISO 7916, m/s ²			
Idle speed, rear/front handles:	3,1/4,1	1,9/3,4	2,2/2,6
Max. speed, rear/front handles:	5,4/4,4	6,7/4,6	4,9/6,0
Blades			
Length, mm	550	550	550
Blade speed, cuts/min	4184	4184	4184

Note 1: Equivalent noise pressure level is calculated as the time-weighted energy total for noise pressure levels under various working conditions with the following time distribution: 1/2 idle and 1/2 max. speed.



FEDERAL EMISSION CONTROL WARRANTY STATEMENT

YOUR WARRANTY RIGHTS AND OBLIGATIONS

The EPA (The US Environmental Protection Agency), Environment Canada and Husqvarna Forest & Garden are pleased to explain the emissions control system warranty on your 2001 and later small nonroad engine. In U.S. and Canada, new small nonroad engines must be designed, built and equipped to meet the federal stringent anti-smog standards. Husqvarna Forest & Garden must warrant the emission control system on your small nonroad engine for the period of time listed below provided there has been no abuse, neglect or improper maintenance of your unit. Your emission control system includes Parts such as the carburetor and the ignition system. Where a warrantable condition exists, Husqvarna Forest & Garden will repair your small nonroad engine at no cost to you. Expenses covered under warranty include diagnosis, parts and labor.

MANUFACTURER'S WARRANTY COVERAGE

The 2001 and later small nonroad engines are warranted for two years. If any emission related part on you engine (as listed above) is defective, the part will be repaired or replaced by Husqvarna Forest & Garden.

OWNER'S WARRANTY RESPONSIBILITIES

As the small nonroad engine owner, you are responsible for the performance of the required maintenance listed in your Operator's Manual. Husqvarna Forest & Garden recommends that you retain all receipts covering maintenance on your small nonroad engine, but Husqvarna Forest & Garden cannot deny warranty solely for the lack of receipts or for your failure to ensure the performance of all scheduled maintenance. As the small nonroad engine owner, you should, however, be aware that Husqvarna Forest & Garden may deny you warranty coverage if your small nonroad engine or a part of it has failed due to abuse, neglect, improper maintenance, unapproved modifications or the use of parts not made or approved by the original equipment manufacturer. You are responsible for presenting your small nonroad engine to a Husqvarna Forest & Garden authorized servicing dealer as soon as a problem exists. The warranty repairs should be completed in a reasonable amount of time, not to exceed 30 days. If you have any questions regarding your warranty rights and responsibilities, you should contact your nearest authorized servicing dealer or call Husqvarna Forest & Garden at 1-800-487-5963

WARRANTY COMMENCEMENT DATE

The warranty period begins on the date small nonroad engine is delivered.

LENGTH OF COVERAGE

Husqvarna Forest & Garden warrants to the initial owner and each subsequent purchaser that the engine is free from defects in materials and workmanship which cause the failure of a warranted part for a period of two years.

WHAT IS COVERED

REPAIR OR REPLACEMENT OF PARTS Repair or replacement of any warranted part will be performed at no charge to the owner at an approved Husqvarna Forest & Garden servicing dealer. If you have any questions regarding your warranty rights and responsibilities, you should contact your nearest authorized servicing dealer or call Husqvarna Forest & Garden at 1-800-487-5963

WARRANTY PERIOD Any warranted part which is not scheduled for replacement as required maintenance, or which is scheduled only for regular inspection to the effect of "repair or replace as necessary" shall be warranted for 2 years. Any warranted part which is scheduled for replacement as required maintenance shall be warranted for the period of time up to the first scheduled replacement point for that part.

DIAGNOSIS The owner shall not be charged for diagnostic labor which leads to the determination that a warranted part is defective, if the diagnostic work is performed at an approved Husqvarna Forest & Garden servicing dealer.

CONSEQUENTIAL DAMAGES Husqvarna Forest & Garden may be liable for damages to other engine components caused by the failure of a warranted part still under warranty.

WHAT IS NOT COVERED

All failures caused by abuse, neglect or improper maintenance are not covered.

ADD -ON OR MODIFIED PARTS

The use of add-on or modified parts can be grounds for disallowing a warranty claim. Husqvarna Forest & Garden is not liable to cover failures of warranted parts caused by the use of add-on or modified parts.

HOW TO FILE A CLAIM

If you have any questions regarding your warranty rights and responsibilities, you should contact your nearest authorized servicing dealer or call Husqvarna Forest & Garden at 1-800-487-5963

WHERE TO GET WARRANTY SERVICE

Warranty services or repairs shall be provided at all Husqvarna Forest & Garden authorized servicing dealers.

MAINTENANCE, REPLACEMENT AND REPAIR OF EMISSION-RELATED PARTS

Any Husqvarna Forest & Garden approved replacement part used in the performance of any warranty maintenance or repairs on emission-related parts, will be provided without charge to the owner if the part is under warranty.

EMISSION CONTROL WARRANTY PARTS LIST

- 1 Carburetor and internal parts
- 2 Intake pipe, airfilter holder and carburetor bolts.
- 3 Airfilter and fuelfilter covered up to maintenance schedule.
- 4 Ignition System
 - 1 Spark Plug, covered up to maintenance schedule
 - 2 Ignition Module
- 5 Muffler with catalytic converter

MAINTENANCE STATEMENT

The owner is responsible for the performance of all required maintenance, as defined in the operator's manual.

1140200-95



2003-09-15

Free Manuals Download Website

<http://myh66.com>

<http://usermanuals.us>

<http://www.somanuals.com>

<http://www.4manuals.cc>

<http://www.manual-lib.com>

<http://www.404manual.com>

<http://www.luxmanual.com>

<http://aubethermostatmanual.com>

Golf course search by state

<http://golfingnear.com>

Email search by domain

<http://emailbydomain.com>

Auto manuals search

<http://auto.somanuals.com>

TV manuals search

<http://tv.somanuals.com>